

CADILLAC MOTOR CAR CO.
Miscellaneous

1904 The Cadillac automobile.

LIBRARY REFERENCE COPY
NOT TO CIRCULATE

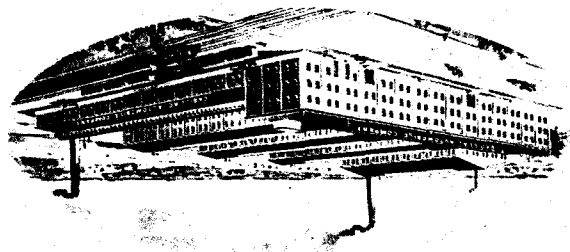

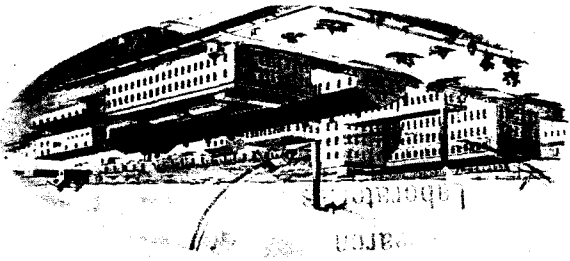

—
PRESS OF
R. L. POLK PRINT-
ING COMPANY, INC.
DETROIT, MICH.

IN presenting our 1904 Catalogue we wish to call your attention to some reasons why you should investigate the Cadillac, if you are interested in automobiles.

We have not had a decade of experience, but our first year, 1903, placed us second in the list of automobile manufacturers in the world. Intelligent thought, well directed energy and mechanical ability of a high order, combined, gave us a practical vehicle from the first. We do not offer you Type VIII, or Model Q, indicating the present stage of a series of costly, ill-advised experiments, neither were we ever compelled to "wipe the slate clean and begin all over again" in order to produce a marketable car. In 1903 we started RIGHT and finished RIGHT.

We were fortunate in securing the entire output of motors, transmission gears, and other motor accessories of the Leland & Faulconer Manufacturing Co., whose reputation in the mechanical world is unexcelled. This is the best possible guarantee that our motor, the heart of the automobile, has reached as high a standard of perfection as any automobile motor in the world.

The name of the Leland & Faulconer Manufacturing Co. stands for the highest type of mechanical skill, while their experience has been wide and varied. They have in the past manufactured thousands of motors under contract, for motor cars, marine and stationary purposes.

Cadillac motors and cars contain more novel and exclusive features of merit than any one firm has ever before offered. They are manufactured under and protected by the patents, issued and pending, of their inventor and designer, Mr. Alanson P. Brush.

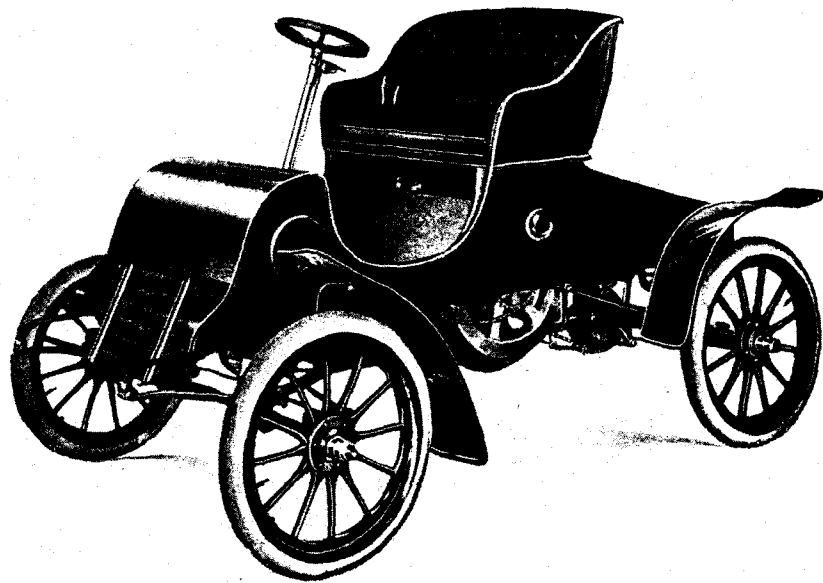

1904
MODEL A. RUNABOUT

SPECIFICATIONS

Tread	54½ inches
Wheels	28 inches
Tires	3 inches
	Heavy, Goodrich Double Tube, Detachable.
Color	Maroon
	With Black Trimmings.
Gear	Standard 9-38
	Options, 9-31, 9-34, 9-41.

Price, - \$750.00
Net F. O. B. Detroit.

See Page 31 for Extras, Etc.

Member of Licensed Association of Automobile
Manufacturers.

THE machine shown on the opposite page differs in no essential details from the first Cadillac ever built.

It was this machine, equipped with a detachable tonneau, as shown on page 6, that in a single season made the name "Cadillac" as applied to automobiles famous; not only in the United States, but in all the principal countries of Europe—in fact, the world over.

The Cadillac, as presented to the public in 1903, was a continual surprise to our customers, our competitors, even to ourselves, for it has been made to do all kinds of heretofore impossible stunts—winning road and track races when pitted against cars of several times its rated power and price—drawing a five ton truck load of railroad iron up a four per cent grade—climbing the capitol steps at Washington, D. C.—climbing the county building steps at Detroit, the record for steep grade climbing of any kind, and finally running an ensilage cutter that ordinarily took an eight or ten horse power stationary engine.

We have often been asked why the 1903 Cadillac, rated at six and one half horse power, could show so great a superiority over cars of much higher power. In reply we state that while we do not wish to suggest that other cars are rated higher than they test, we do know that one horse power with us means 33,000 actual foot pounds of work per minute; or in other words, the work necessary to lift a 33,000 pound weight one foot in one minute. We also know that no motor is put into a "Cadillac" car unless it will develop *more than its rated horse power.*

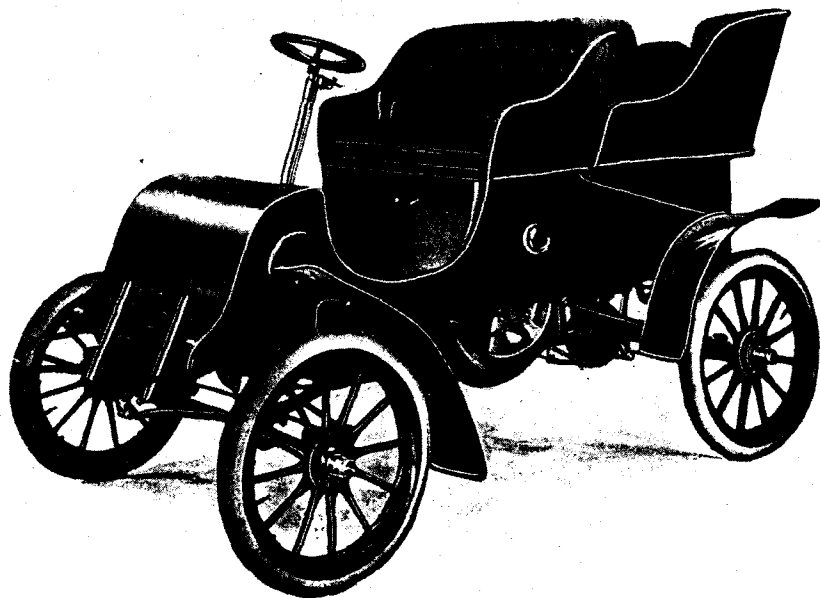

1904
**MODEL A. DETACHABLE
 TONNEAU**

SPECIFICATIONS

Tread 54½ inches
 Wheels 28 inches
 Tires 3 inches
 Heavy, Goodrich Double Tube, Detachable.
 Color Maroon
 With Black Trimmings.
 Gear Standard 9-38
 Options, 9-31, 9-34, 9-41.

Price, - \$850.00
 Net F. O. B. Detroit.

See Page 31 for Extras, Etc.

Member of Licensed Association of Automobile
 Manufacturers.

We do not mean to say, because the 1903 Cadillac won such popularity, that we lay claim to a *perfect* automobile. We do claim, however, that in the hands of our customers, our cars have demonstrated a "get there without trouble" quality, which has given us our present standing in the automobile world.

For 1904 we combine, with the advance in essential features which the 1903 cars represented, an equally progressive policy of improvement in all minor details. One of the most important of these minor improvements, is the introduction of a much more reliable and substantial electrical outfit than it has heretofore been possible to obtain.

An endless array of devices, good, bad and indifferent, have recently been designed to overcome the troubles arising from forgotten lubrication. Pumps, cams, check valves, relief valves, gears, chains, belts, etc., are being tried in the effort to produce an oiler that will feed when the engine runs, and stop when the engine stops. The Cadillac for 1904 is provided with a simplification instead of a complication. A switch combined with the oil feed in such a manner that when the oil is cut off the electric current is also off, and so arranged that *either* battery or *both* can be turned on, but not without turning on the oil feed as well.

By a perfectly automatic arrangement, the accumulation of any excess of lubricating oil in the combustion chamber is prevented, thereby making the motor more economical in the use of oil, at the same time assuring a more perfect cylinder lubrication than has ever before been obtained in any gasoline engine. This innovation prevents carbon deposits either in the

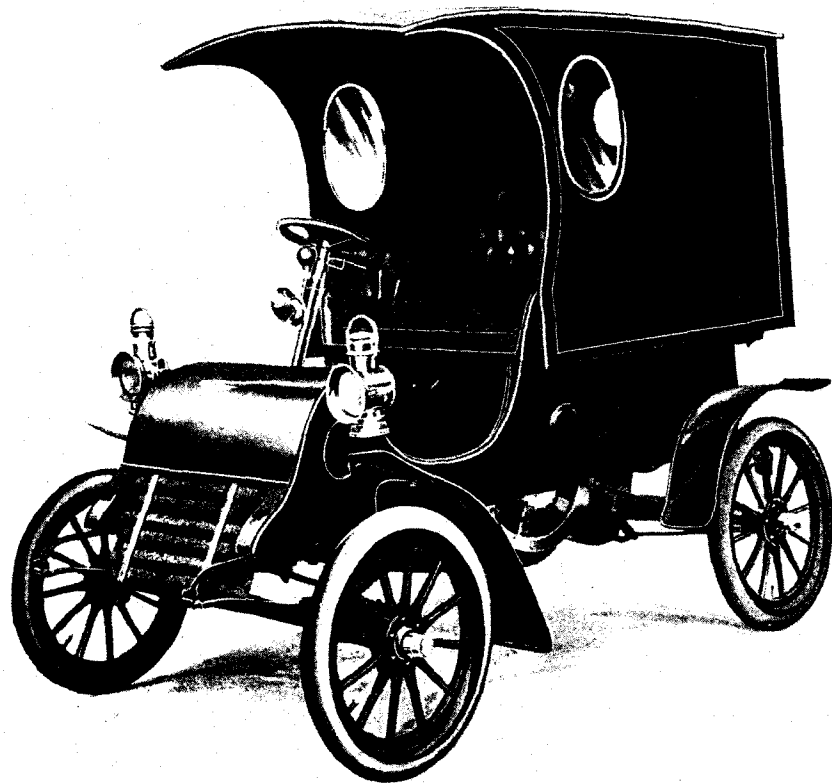

1904
MODEL A. DELIVERY

SPECIFICATIONS

Tread	54½ inches
Wheels	28 inches
Tires	3 inches
	Heavy, Goodrich Double Tube, Detachable.
Color	Maroon
	With Black Trimmings.
Gear	Standard 9-41

Price, - \$850.00
 Net F. O. B. Detroit.

See Page 31 for Extras, Etc.

Member of Licensed Association of Automobile
 Manufacturers.

combustion chamber or on the spark plug, thus insuring even greater satisfaction from our double insulated spark plugs, which have demonstrated a surprising superiority over all others, and have been used exclusively by customers, though we provide an arrangement whereby any plug can be substituted.

Other minor innovations in construction of 1904 Cadillacs are: a convenient extension of the arrangement for flushing the carburetor; an extension for one of the small grease cups which, though it needed only occasional attention, was rather unhandy to reach; improvements in the details of body construction, to prevent any possibility of rattling or soiling one's clothes; improved springs, brakes, tires, etc.

To anyone desiring a popular priced car, possessing all the essential features of the most expensive touring cars, we unhesitatingly recommend the Cadillac. It has been demonstrated to be a splendid hill climber, capable of taking four people anywhere that wheels can go, and as fast as ordinary roads will permit.

The automobile manufacturer who does not offer a liberal option on gears is as far behind the times as a bicycle manufacturer would be who attempted a similar policy. Our 1904 standard sprocket equipment is 9 and 38 teeth, with options on 9-31, 9-34 and 9-41.

The 9-31 combination we recommend only for runabouts on good roads. The 9-34 combination is all right for tonneau machines to be used on good roads and pavements. Both of these make fast machines, capable of thirty miles an hour or better when not overloaded.

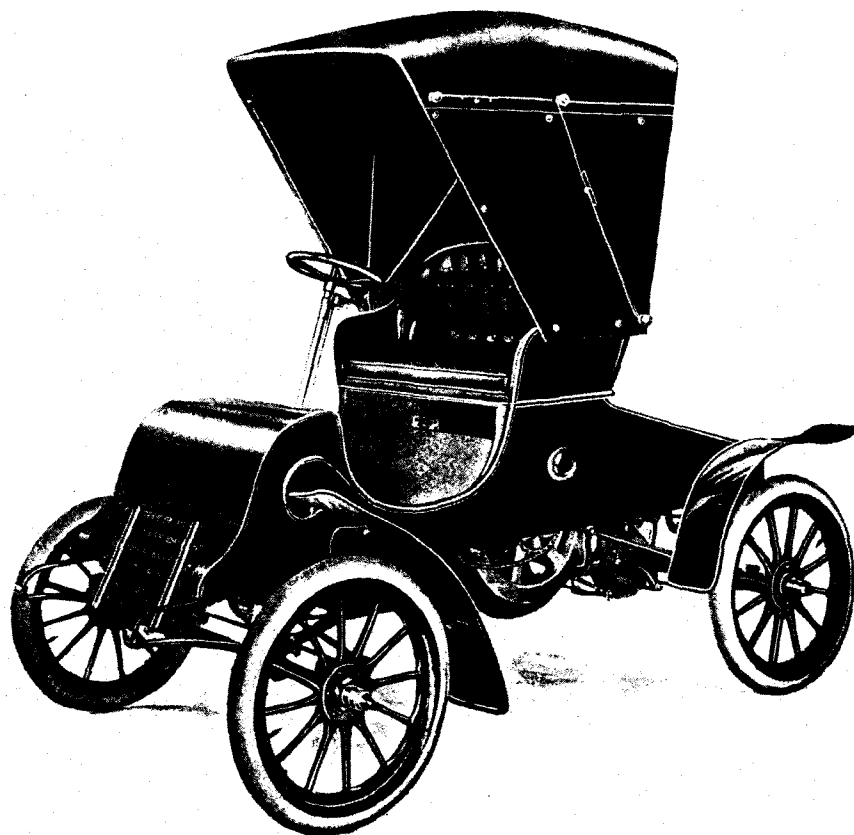

1904
MODEL A. RUNABOUT
 WITH TOP

SPECIFICATIONS

Tread	54½ inches
Wheels	28 inches
Tires	3 inches
	Heavy, Goodrich Double Tube, Detachable.
Color	Maroon
	With Black Trimmings.
Gear	Standard 9-38
	Options, 9-31, 9-34, 9-41.
Price, {	Leather Top, complete, { \$800.00
	with Sides and Storm Apron. }
Price, {	Rubber Top, complete, { \$780.00
	with Sides and Storm Apron. }
	Net F. O. B. Detroit.

See Page 31 for Extras, Etc.

Member of Licensed Association of Automobile
 Manufacturers.

The standard 9-38 equipment is the best for all-around work, and will give a speed of twenty-five miles per hour where conditions are at all favorable.

For all delivery machines and such tonneau cars as are to be used on exceptionally bad roads, or in very hilly country, we recommend the 9-41 combination, which makes a car that will climb any grade of any traveled road.

The improvements, conveniences and options, referred to in this catalogue, combine to make the Cadillac automobile for 1904 the sturdiest, staunchest, most reliable car on the market, and all at a price which turned the automobile world topsy-turvy, just one year ago. To those who said the Cadillac was too much for the money and could not continue to be built for the price, we only state that after a year's experience we offer in the 1904 Model A Cadillac twenty-five per cent more value at the same price. This we are able to do by reason of our improved system and greatly increased facilities. We have demonstrated that a forty or fifty per cent better automobile, can be built and marketed at the same price, if the yearly output be several thousands instead of several hundreds—or just several.

When you buy, be sure YOU get the saving which necessarily results from manufacturing on a large scale.

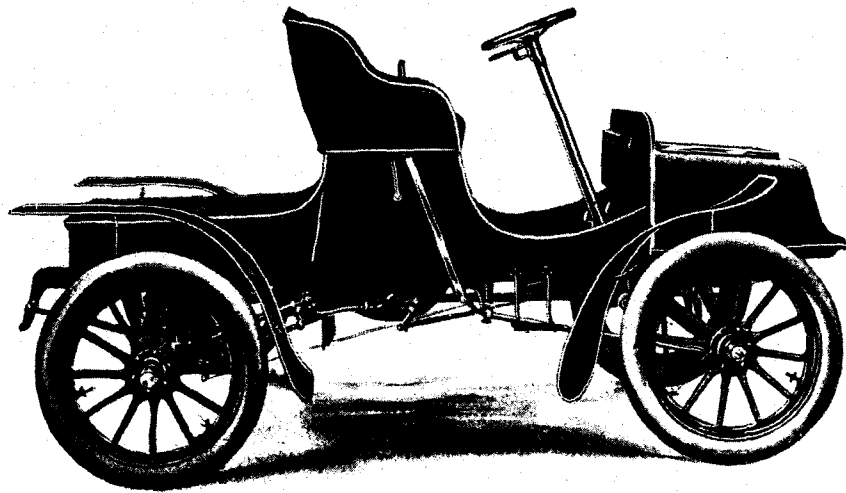

1904
MODEL B. RUNABOUT

SPECIFICATIONS

Tread	54½ inches
Wheels	30 inches
Tires	3 inches
	Heavy, Goodrich Double Tube, Detachable.
Color	Maroon
	With Black Trimmings.
Gear	Standard 10 38
	Options, 10-31, 10-34, 10-41.

Price, - \$800.00
Net F. O. B. Detroit.

See Page 31 for Extras, Etc.

Member of Licensed Association of Automobile
Manufacturers.

DURING the year 1903 we found a demand for a higher grade car than it was possible to build for the low price at which the Model A cars were sold. In answer to this demand we have broadened our line by the addition of the four cars shown on pages 12, 14, 16 and 18. These cars represent a long and logical step forward in the development of the automobile, and to appreciate fully the advance they represent, let us consider the automobile as a road locomotive.

The resistance due to soft roads is caused by the wheels imbedding themselves more or less in the surface, and by reason of this a light car has a great advantage over a heavy one. So great is this advantage that a 1200 pound car equipped with an eight horse power motor will travel American roads easier than a 2000 pound car having twenty horse power, although the ratio of weight to power is considerably in favor of the heavier one.

The result is that if eight or nine horse power can be put into a car weighing 1200 pounds, which at the same time combines ample strength and roomy, comfortable seating arrangements, we then have an automobile which suffers in comparison with the highest priced touring cars only on hard, level speedways, while the advantages of the light car are:—lower first cost, less cost of fuel, oil and repairs, **EQUAL SPEED** on ordinary roads, because the ordinary road

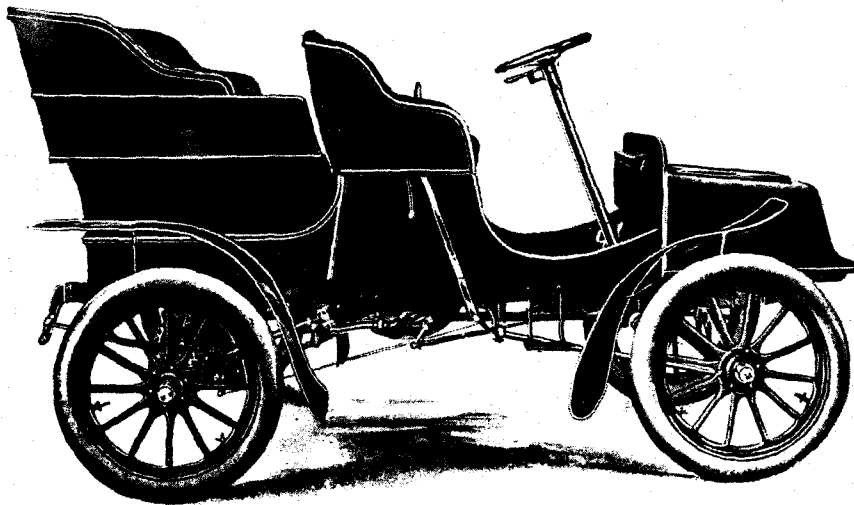

1904
MODEL B. TOURING CAR

SPECIFICATIONS

Tread 54½ inches
 Wheels 30 inches
 Tires 3 inches
 Heavy, Goodrich Double Tube, Detachable.
 Color Maroon
 With Black Trimmings.
 Gear Standard 10-45
 Options, 10-34, 10-38, 10-41.

Price, - \$900.00
 Net F. O. B. Detroit.

See Page 31 for Extras, Etc.

Member of Licensed Association of Automobile
 Manufacturers.

will not permit of a speed equal to the capacity of either machine, and **GREATER ABILITY** on roads that are at all soft or sandy.

Our Model B cars embody this well nigh perfect combination of roomy comfort in seating four passengers, great strength, sufficient for the hardest usage on typical American roads, long wheel base, soft springs, and are light enough to be perfectly handled by our eight and one quarter horse power motor.

The wonderful increase in value which this automobile presents over any other, either at or near its price, is only possible when manufactured in a perfectly systematized and equipped factory having a large output, for the reason that each piece must be made of special material, and with special tools to form it exactly proportionate to the strain and wear to which it is to be subjected. The preparation for the production of these parts dates back to the making of special grades of steel solely for the various parts of Cadillac automobiles, and it is only by such careful preparation that we are able to offer the really scientific construction shown in our Model B cars, which we believe to be as high a type of automobile as has ever been produced at **ANY PRICE.**

The Runabout, shown on page 12, may be geared up until it is capable of speed enough to satisfy the most reckless driver, and yet have ample power for the worst possible roadway.

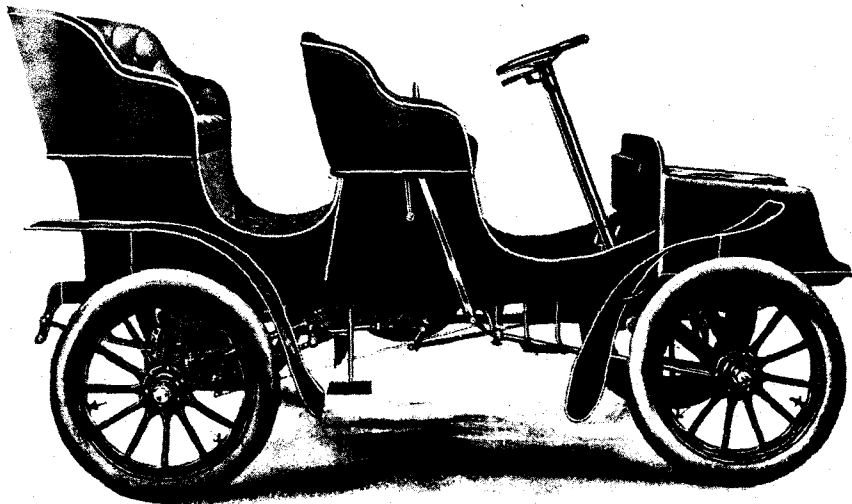

1904
MODEL B. SURREY

SPECIFICATIONS

Tread 54½ inches
Wheels 30 inches
Tires 3 inches
Heavy, Goodrich Double Tube, Detachable.
Color Maroon
With Black Trimmings.
Gear Standard 10-41
Options, 10-31, 10-34, 10-38.

Price, - \$900.00
Net F. O. B. Detroit.

See Page 31 for Extras, Etc.

Member of Licensed Association of Automobile
Manufacturers.

The car shown on page 14, is a Touring Car in every sense of the word, being the simplest, safest, strongest, and most economical ever produced; one that will carry four passengers comfortably, and give a good account of itself on any road.

The Surrey, shown on page 16, is only another form of the touring car for those who prefer to get in and out at the side, instead of the rear.

The Delivery, page 18, just meets the requirements of the merchant who is tired of using three men and as many horses for the work that can be done better by one man and a Cadillac.

All the Model B Cadillacs have the bodies so arranged that they may be removed from the chassis simply by unscrewing the attaching screws and sliding the bodies back, without any lifting whatsoever. Then the chassis is a complete automobile to be tested, adjusted, or repaired with the most perfect accessibility possible.

In our Model B cars we continue the use of our single cylinder horizontal engine with a direct chain drive to the rear axle, because in all powers below eleven or twelve horse power this type of motor has everything to recommend it over any other style. The complication and multiplication of the parts necessary makes it impossible to build any other type of motor and maintain our high mechanical standard at anywhere near the same price. The question of

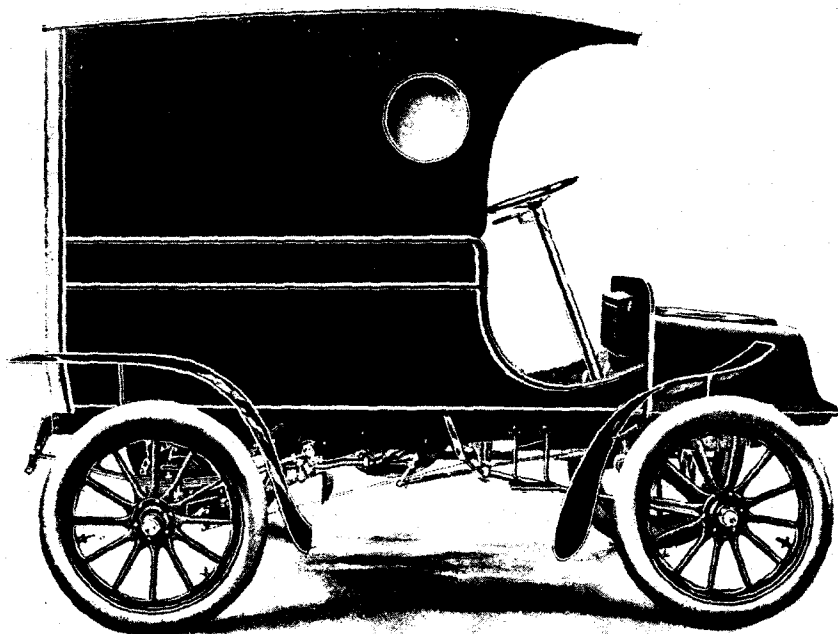

1904
MODEL B. DELIVERY

SPECIFICATIONS

Tread	54½ inches
Wheels	30 inches
Tires	3 inches
Heavy, Goodrich Double Tube, Detachable.	
Color	Maroon
With Black Trimmings.	
Gear	Standard 9-45

Price, - \$900.00
Net F. O. B. Detroit.

See Page 31 for Extras, Etc.

Member of Licensed Association of Automobile
Manufacturers.

vibration is the only point that can be urged against the single cylinder engine, and since this, in a properly designed and balanced motor is difficult to detect, except when the car is standing still, it can hardly be seriously considered.

In a horizontal engine the direction of rotation should always be such that the side thrust of the piston on the working stroke is downward against the LOWER side of the cylinder, which is at all times coolest and best lubricated. In the two cylinder opposed type this is impossible in both cylinders, as one piston must get the side thrust on the working stroke upward against the TOP of the cylinder. This difficulty can only be met by giving that cylinder an excess of oil, necessarily causing carbon deposits in the combustion chamber, on the spark plugs, sticky exhaust valve stems and various other troubles that attend an excessive amount of lubricating oil in the cylinder.

The NOVICE is sometimes told that if he has a two cylinder engine he can always depend on one of them to "bring him home" if the other fails, but one should remember that the one live cylinder has no small load to carry to work the dead one, besides having a fly wheel too light for impulses coming only half as often as they should.

If you want to be sure of getting back, have ONE cylinder — MADE RIGHT; in other words, buy a CADILLAC.

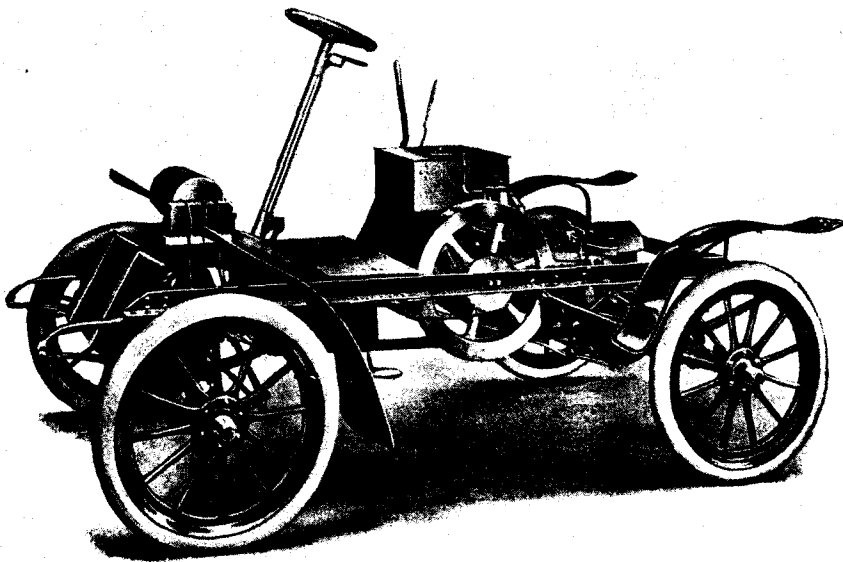

1904
MODEL A. CHASSIS

Is used interchangeably under all Model A Cadillacs. Bodies can be quickly removed or changed without disturbing the working parts in any way.

SPECIFICATIONS

Frame—angle iron, with drop forged outriggers and spring hangers, all hot riveted in place.

Best improved heavy 1904 model, Whitney roller chain, 1 inch pitch.

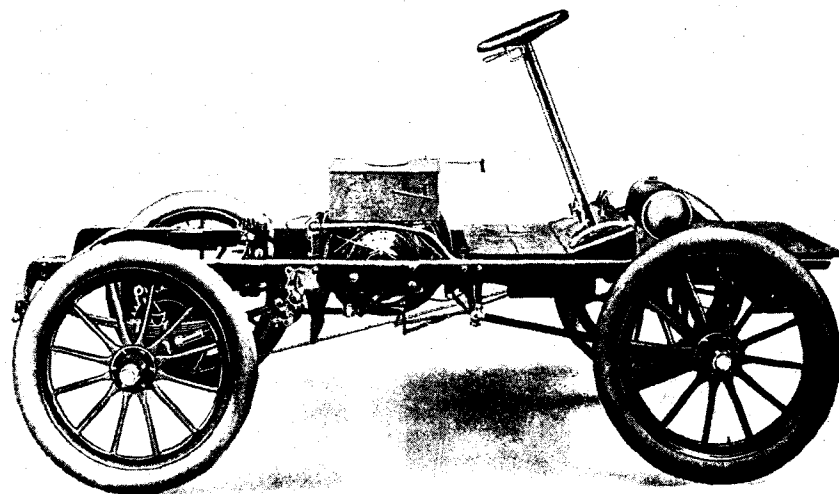

1904
MODEL B. CHASSIS

Is used under all Model B cars. All bodies can be quickly removed *without lifting* and without disturbing any of the working parts.

SPECIFICATIONS

Frame—cold rolled pressed steel with outriggers and spring hangers, drop forged and hot riveted in place.

Three spring suspension, giving absolute flexibility.

Best improved heavy 1904 model, Whitney roller chain, 1 inch pitch.

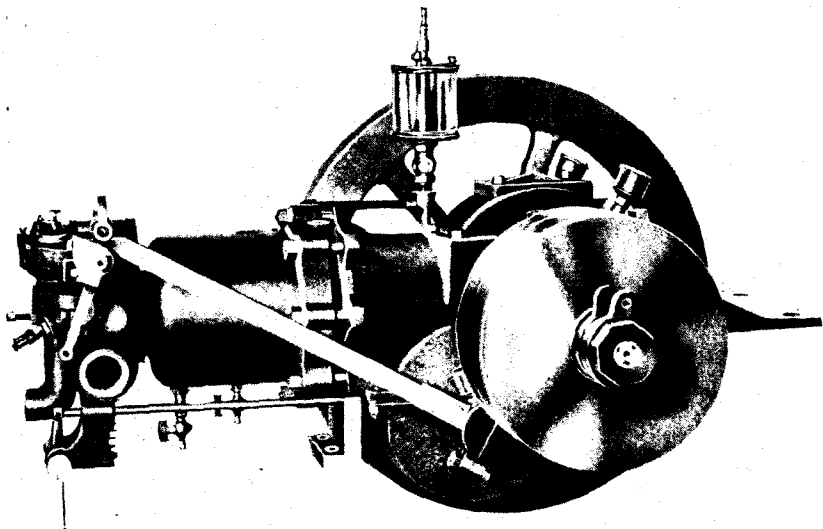

CADILLAC MOTOR

In the little Hercules, illustrated above, we have followed the policy of true progress — we started with a good thing and made it better. The usual method is to start with any NEW thing, sell all that is possible by reason of its NEWNESS, then try another.

After a year's experience, we know just where we are at, and our PROGRESS has been along the lines of MORE strength with LESS weight in the rest of the car; MORE power from the SAME engine; and we can, with absolute honesty, rate the motor for the 1904 Cadillac cars, both Models A and B, at 8¼ horse power.

To our unexpectedly large number of lady drivers we wish to state that this year's motor is provided with a compression relief, which makes starting mere play for the most delicate wrist.

The absolute interchangeability of EVERY wearing surface on the motor will be maintained as heretofore for no motor can honestly be termed first-class without this provision against expensive repairs in case of accidental neglect.

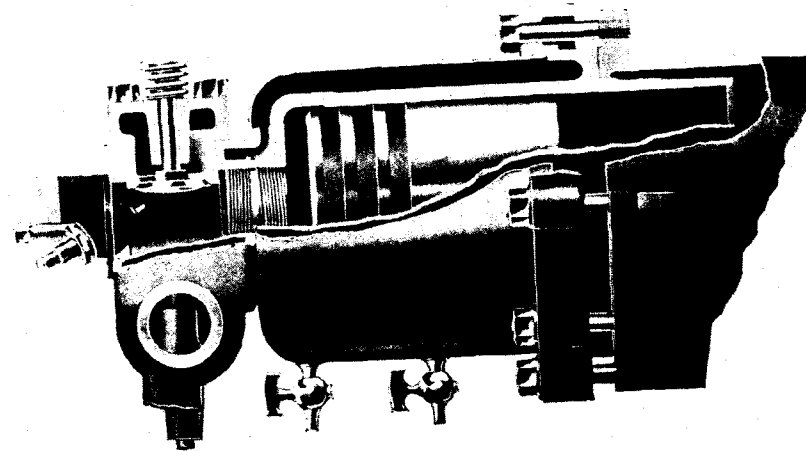

WATER JACKET

A year's experience with our copper water jacket has made our agents and customers pronounce it the ONLY practical system of jacketing.

It has no gaskets to burn, soak, or blow out; no leaded joints to melt out; no intricate coring on the cylinder, consequently no unexpected defects showing up; neither does a little neglect cost the inexperienced user a small fortune for a new cylinder.

These details mean little or nothing to the novice or the driver of a Cadillac, but they do mean something to the user of some other form of construction, who, perchance has left his machine forty miles from home and then sent a mechanic out to put in a new cylinder gasket. They mean something also to the chauffeur who may have tried to start his motor with a defective gasket which was leaking water into the combustion chamber.

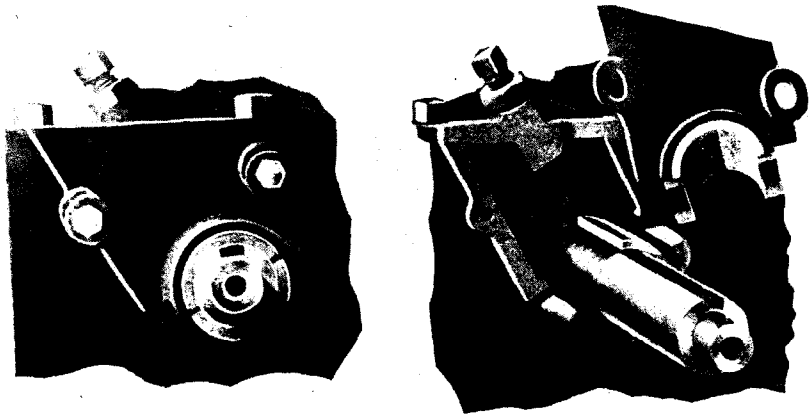

SHAFT BEARINGS

These two cuts are self-explanatory, showing how the main shaft bearings may be interchanged without removing the shaft from the motor.

This is a fine illustration of the thoroughness with which the details of the Cadillac motor have been worked out.

In most automobiles these bearings are usually made by casting babbitt metal into the frame of the engine, which means, of course, that if a bearing is allowed to cut, the motor must be returned to the factory if any PROPER repair is to be made.

In the Cadillac, however, the babbitt facing is backed by a finished piece of bronze, which fits the frame of the engine and the bearing cap in such a way that a bearing may be replaced in a few minutes, and the alignment of the shaft will be as good as when the motor was new.

The system of making these bearings also permits the babbitt facings to be COMPRESSED, thereby making them much more durable than when simply CAST in place.

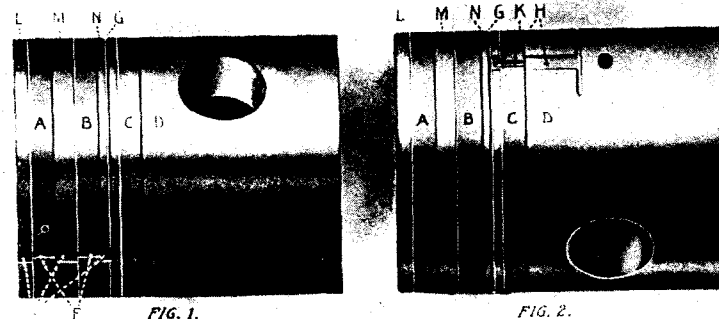

FIG. 1.

FIG. 2.

PISTON

Without the addition of one single part, we present the first and only arrangement that prevents the accumulation of any excess of lubricating oil in the combustion chamber and at the same time INSURES perfect piston lubrication.

In Fig. 1 (the BOTTOM of piston) the junk rings L, M and N, and the first two packing rings, A and B, are grooved, forming a passage to the circular groove G, which continues around the junk ring, N, connecting with the grooves H and K (on top of the piston), Fig. 2, thus forming a passage past the third packing ring, C.

The result is, that any excess of oil on the lower part of the cylinder wall is FORCED into the circular groove around each side of the piston and out on the top, thereby encircling the piston with a ring of oil in the groove, G.

The passage is too small to produce any loss of power whatsoever, but maintains the most perfect lubrication possible at all points in the cylinder, USING the oil that usually causes all kinds of trouble.

CADILLAC TRANSMISSION

The Cadillac transmission combines strength, durability, quietness and requires the least possible attention, which are virtues not possessed by any other gear.

The driving gear, D, is the only part attached to the engine shaft. When assembled, the cover, C, and case, H, form an oil reservoir enclosing all the working parts, thus insuring the best possible lubrication with the least attention. It has but ONE oil hole instead of the usual 10 or 12, and will hold enough oil for SEVERAL DAYS of the hardest use.

If the case, H, be held by its brake band when driving gear is rotating, all the gears in the case, except B, run at the same speed as the engine shaft, *but no faster*. The gear, B, and with it the driving sprocket, A, runs at a lower speed, but in the opposite direction, thus producing the reverse. If the case be allowed to revolve, and the drum, K, be held by its brake, all the gears run at much lower speed than the engine shaft, driving internal gear, B, around slowly forward, producing the slow speed. If brake drum, K, be locked to shaft by the high speed clutch, the whole gear revolves and acts as an additional fly-wheel.

By driving through gear, B, and engaging at three points, the lowest possible tooth strains are secured. All the gears are large; none of them can ever run as fast as the engine except in backing. These strong points of advantage form a combination of virtues never before secured in any transmission and make the Cadillac transmission the IDEAL GEAR for its duty.

Remember that the Cadillac transmission has none of the following defects, some of which are found in all other gears: several points to oil; high tooth strains; weak toothed pinions, running at several times the engine speed; short, inadequate bearings. In plain words, the Cadillac gear is made RIGHT.

CADILLAC SPARK PLUG

Our double insulated spark plug, illustrated opposite, needs no further explanation or recommendation.

It allows the secondary current to be kept separate from the rest of the mechanism.

Ask a coil maker if it is right; or a customer how it works.

We provide for the use of ANY plug desired, but last year our own special plug was ALWAYS used.

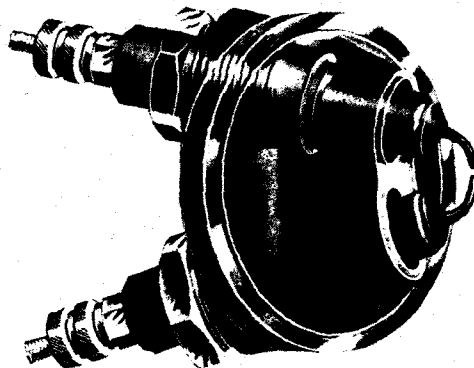
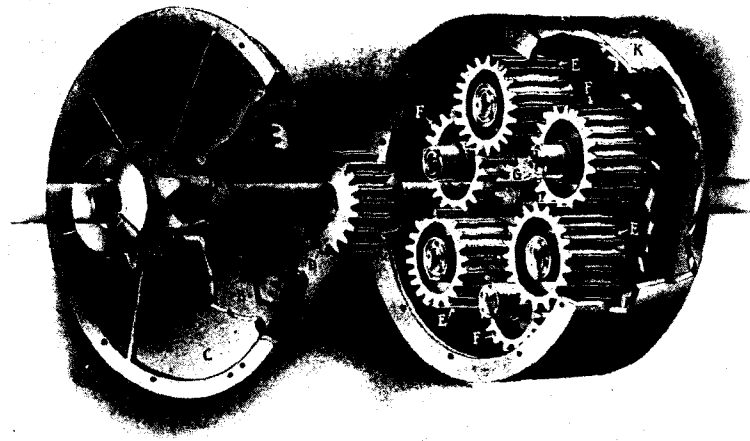

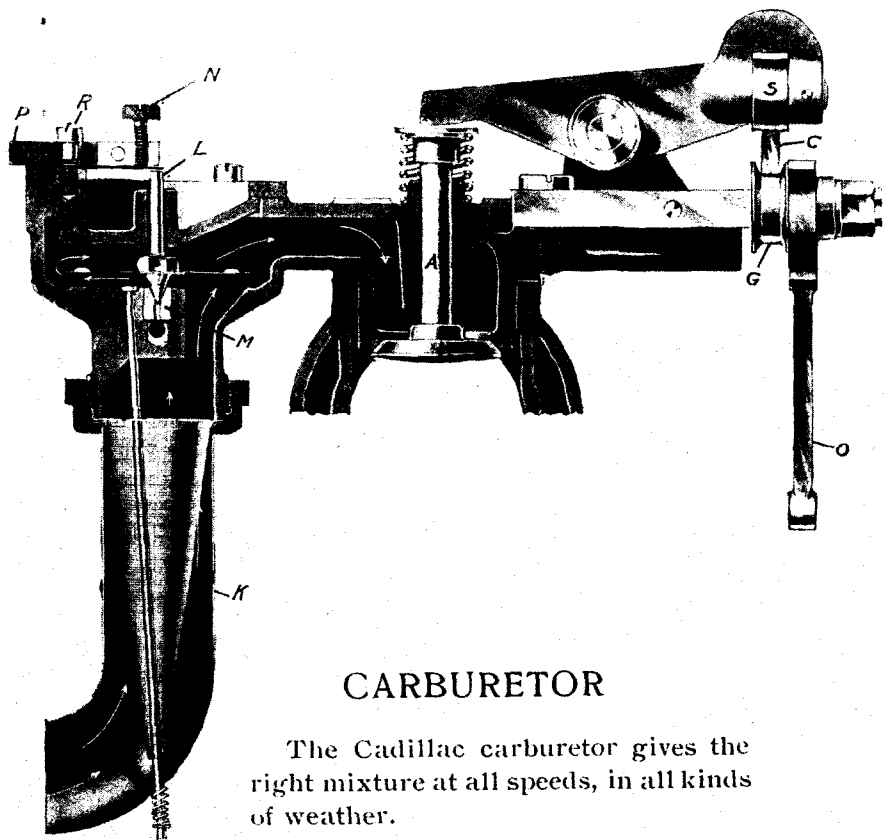

CARBURETOR

The Cadillac carburetor gives the right mixture at all speeds, in all kinds of weather.

It gives the proper mixture for starting with such certainty, that in the engine factory testing department no starting crank or device of any kind is ever used.

Of course this carburetor can get clogged by dirty fuel, the same as any other, but unlike the others, it can be taken apart, cleaned and put together in a few minutes without even changing the adjustment.

Having no bothersome float, it is not affected by changes of altitude, steep grades, sharp corners, or sudden starting or stopping.

It will work tipped at an angle of 30° or 40°, as well as on the level.

It is the RIGHT kind of a carburetor.

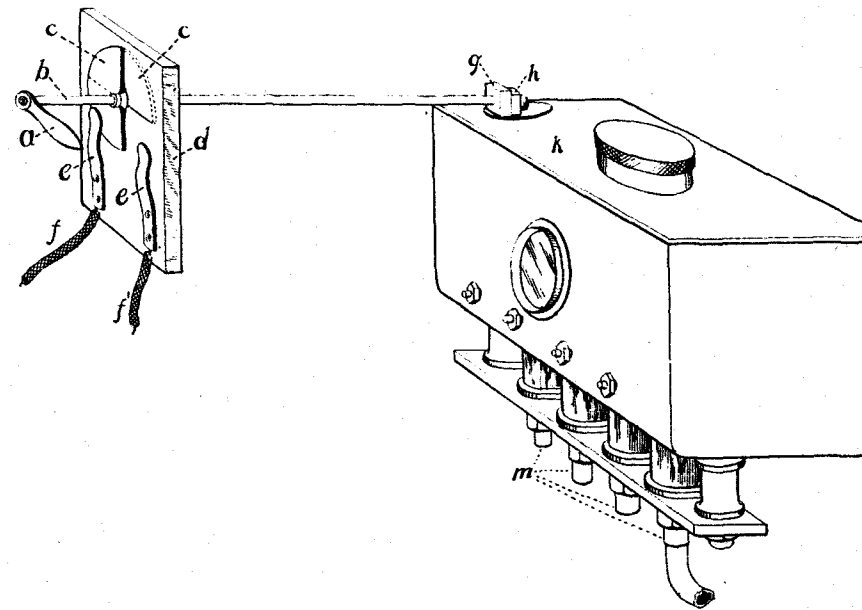

OIL AND SWITCH SYSTEM

A novel switch arrangement is shown in the illustration above. It prevents the oil feed from being forgotten by making the handle, A, which turns the oil on or off also turn the electric current on and off.

As shown in the cut, the battery connected to the wire, F, is in operation and the oil is turned on; if the handle, A, be turned down, the half disc, C, does not make a connection with either battery, neither is the oil turned on; if the handle, A, be turned horizontally in the opposite direction to that shown in the cut, the battery connected with wire, F¹, becomes operative; in case the batteries become weak, the handle, A, may be turned directly up, thus connecting BOTH batteries.

This 1904 device is simple and positive in its action. With it you cannot start your motor without turning on the oil. You cannot stop the motor and leave the oil feeding.

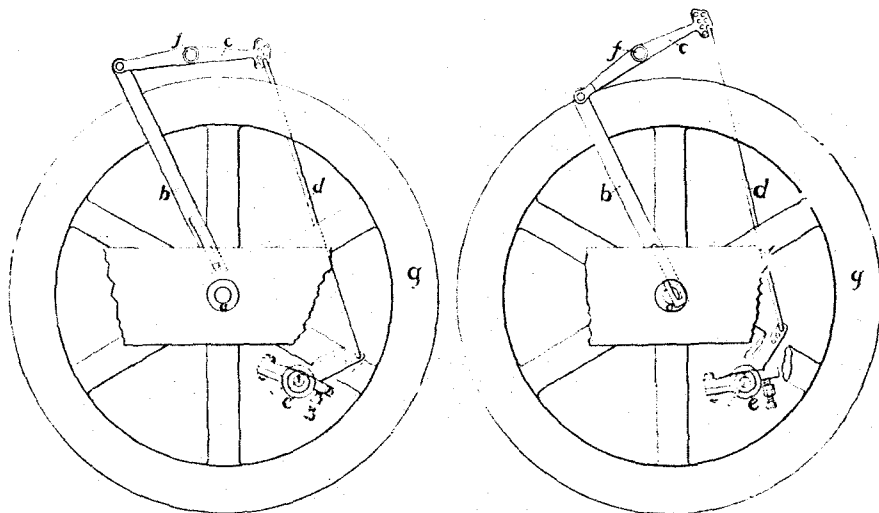

FIG. 1

FIG. 2.

SAFETY STARTING DEVICE

A glance at the two illustrations above will give a comprehensive understanding of the safety starting device, which will be used on all Model B Cadillac Automobiles.

The starting crank can only be inserted when the commutator, E, is in the position shown in Fig. 1 which gives the late ignition for starting, thereby absolutely preventing any chance of accident from trying to start with the ignition set EARLY.

PRICE LIST OF EXTRAS AND GENERAL OUTFIT INFORMATION

When Runabouts are ordered without tops, which purchasers expect to require later, the seats must be ordered "Ironed for Top" and the list price will be increased \$5.00. This is indispensable, as seats cannot be ironed after the upholstering is done. When top is purchased, allowance for ironing will be made.

When automobiles are to be shipped singly long distances, it is advisable to have them crated. Cost of crating is extra, \$10.00 net.

Where purchasers of Model B Touring Cars or Surreys want to use them as Runabouts, decks will be furnished at an extra cost of \$10.00 each.

A full equipment of tools, also tire pump and repair kit is furnished with each automobile, but we do not furnish lamps or horns except as extras.

A complete price list of Cadillac automobile parts will be mailed to any purchaser upon application.

GUARANTEE

The guarantee of the National Association of Automobile Manufacturers covers CADILLAC Automobiles. Parts that we decide are defective will be replaced at our factory, provided they are sent us charges prepaid.

All tires used on CADILLAC Automobiles are guaranteed by the tire manufacturers and should be sent direct to them, transportation charges prepaid.

Goodrich G. & J. Clincher Tires are standard equipment and should be sent to the nearest of the following branch houses of the B. F. Goodrich Co.:

New York City, 66-68 Reade St.	Detroit, 80 E. Congress St.
New York City, 1625 Broadway.	Akron, Ohio.
Chicago, 141 Lake St.	Buffalo, 9 W. Huron St.
Philadelphia, 922 Arch St.	Denver, 1444 Curtis St.
Boston, 157 Summer St.	Cleveland, Superior St.
San Francisco, 392 Mission St.	London, Eng., 7 Snow Hill, E. C.

CADILLAC AUTOMOBILE DEALERS

ALABAMA—Birmingham White-Blakeslee Mfg. Co.
 ARKANSAS—Little Rock Arkansas Auto. Co.
 CALIFORNIA—San Francisco..... Cuyler M. Lee
 " —Los Angeles..... Norman W. Church
 COLORADO—Denver Colorado Auto. Co.
 CONNECTICUT—Hartford Brown, Thomson & Co.
 " —New Haven..... The Holcomb Co.
 " —Middletown..... Caulkins & Post
 " —Stamford Mechaley Bros.
 " —Bridgeport Bridgeport Cycle Co.
 " —South Norwalk..... H. R. Buckley & Co.
 DELAWARE—Wilmington T. C. Bradford
 DISTRICT OF COLUMBIA—Washington..... Pope Mfg. Co.
 FLORIDA—Daytona W. E. French
 " —Tampa Tampa Cycle Co.
 GEORGIA—Atlanta L. E. Fain
 " —Macon J. W. Shinholser & Co.
 ILLINOIS—Chicago Cadillac Co. of Illinois
 " —Harvard..... 3 Manley Bros.
 INDIANA—Indianapolis..... Indiana Automobile Co.
 " —Muncie..... C. S. Wachtel & Son Co.
 IOWA—Des Moines W. J. Riddell
 KENTUCKY—Louisville Motor Vehicle Co.
 LOUISIANA—New Orleans..... Automobile Co., Ltd.
 MARYLAND—Baltimore..... Mar-Dei Mobile Co.
 MASSACHUSETTS—Boston..... Pope Mfg. Co.
 " —Fitchburg..... Iver Johnson Sporting Goods Co.
 " —Springfield Adolf A. Geisel
 " —Worcester..... Birney A. Robinson
 MICHIGAN—Detroit William E. Metzger
 " —Bay City..... F. H. Fenner
 " —Grand Rapids..... Michigan Auto. Co.
 " —Menominee..... D. F. Poyer
 MINNESOTA—Minneapolis Pence Automobile Co.
 MISSOURI—Kansas City..... The Automobile Co.
 " —St. Louis..... Halsey Automobile Co.
 NEBRASKA—Omaha..... Anderson-Millard Co.
 NEW JERSEY—Jersey City..... Crescent Auto. Co.
 " —Newark..... Motor Car Co. of N. J.
 " —Summit..... Chester C. Henry
 NEW YORK—New York City..... Cadillac Co. of N. Y.
 " —Albany and Troy..... James Lucey
 " —Buffalo..... Centaur Motor Co.
 " —Rochester..... Fred. A. Mabbett
 NORTH CAROLINA—Durham..... George Lyon
 " —Wilmington..... Caro. Auto. & Bicycle Co.
 NORTH DAKOTA—Grand Forks..... Houghton Implement Co.
 OHIO—Cleveland..... Ohio Motor Car Co.
 " —Cincinnati..... Hanauer Auto. Co.
 " —Dayton Peckham Carriage Co.
 " —Toledo Lichtie Auto. Co.
 OREGON—Portland..... Lee Automobile Co.
 PENNSYLVANIA—Erie Jacob Roth
 " —Allentown..... O. H. Dietrich Co.
 " —Harrisburg Central Pa. Auto. Co.
 " —Hazleton..... Hazleton Machinery & Supply Co.
 " —Philadelphia..... Pa. Electric Vehicle Co.
 " —Pittsburg Banker Bros.
 RHODE ISLAND—Providence..... Pope Mfg. Co.
 TENNESSEE—Knoxville Schultz-Howard Co.
 TEXAS—Dallas..... Parlin-Orendorff Co.
 " —San Antonio..... Staacke Bros.
 " —El Paso El Paso Auto. Co.
 VERMONT—Barre..... Standard Electric Co.
 VIRGINIA—Richmond..... Foster & Foster
 WISCONSIN—Milwaukee..... Theo. Jonas

CADILLAC MOTOR CAR CO.

Miscellaneous

1904 The Cadillac automobile.

LIBRARY REFERENCE COPY
NOT TO CIRCULATE

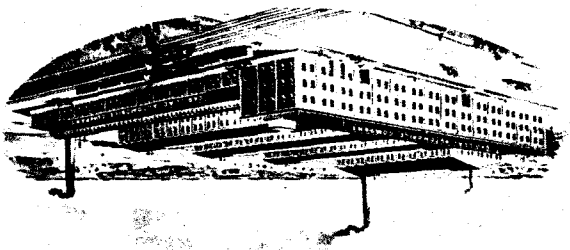
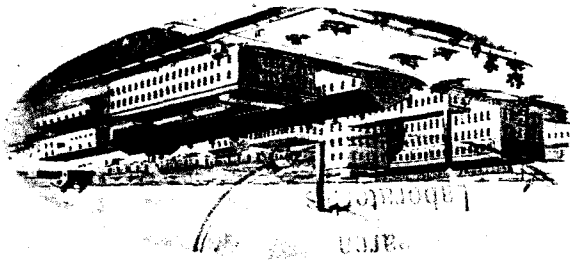



—
PRESS OF
R. L. POLK PRINT-
ING COMPANY, Ltd.
DETROIT, MICH.

IN presenting our 1904 Catalogue we wish to call your attention to some reasons why you should investigate the Cadillac, if you are interested in automobiles.

We have not had a decade of experience, but our first year, 1903, placed us second in the list of automobile manufacturers in the world. Intelligent thought, well directed energy and mechanical ability of a high order, combined, gave us a practical vehicle from the first. We do not offer you Type VIII, or Model Q, indicating the present stage of a series of costly, ill-advised experiments, neither were we ever compelled to "wipe the slate clean and begin all over again" in order to produce a marketable car. In 1903 we started **RIGHT** and finished **RIGHT**.

We were fortunate in securing the entire output of motors, transmission gears, and other motor accessories of the Leland & Faulconer Manufacturing Co., whose reputation in the mechanical world is unexcelled. This is the best possible guarantee that our motor, the heart of the automobile, has reached as high a standard of perfection as any automobile motor in the world.

The name of the Leland & Faulconer Manufacturing Co. stands for the highest type of mechanical skill, while their experience has been wide and varied. They have in the past manufactured thousands of motors under contract, for motor cars, marine and stationary purposes.

Cadillac motors and cars contain more novel and exclusive features of merit than any one firm has ever before offered. They are manufactured under and protected by the patents, issued and pending, of their inventor and designer, Mr. Alanson P. Brush.

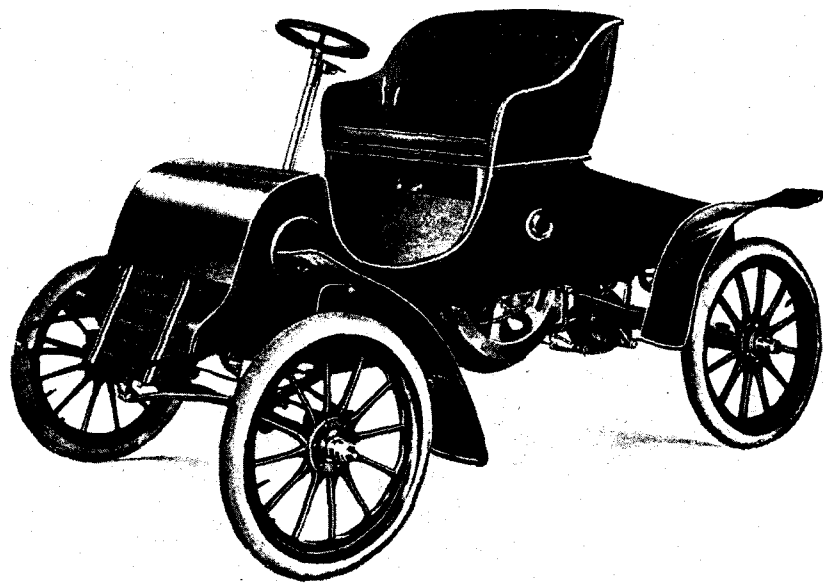

1904
MODEL A. RUNABOUT

SPECIFICATIONS

Tread 54½ inches
 Wheels 28 inches
 Tires 3 inches
 Heavy, Goodrich Double Tube, Detachable.
 Color Maroon
 With Black Trimmings.
 Gear Standard 9-38
 Options, 9-31, 9-34, 9-41.

Price, - \$750.00
 Net F. O. B. Detroit.

See Page 31 for Extras, Etc.

Member of Licensed Association of Automobile
 Manufacturers.

THE machine shown on the opposite page differs in no essential details from the first Cadillac ever built.

It was this machine, equipped with a detachable tonneau, as shown on page 6, that in a single season made the name "Cadillac" as applied to automobiles famous; not only in the United States, but in all the principal countries of Europe—in fact, the world over.

The Cadillac, as presented to the public in 1903, was a continual surprise to our customers, our competitors, even to ourselves, for it has been made to do all kinds of heretofore impossible stunts—winning road and track races when pitted against cars of several times its rated power and price—drawing a five ton truck load of railroad iron up a four per cent grade—climbing the capitol steps at Washington, D. C.—climbing the county building steps at Detroit, the record for steep grade climbing of any kind, and finally running an ensilage cutter that ordinarily took an eight or ten horse power stationary engine.

We have often been asked why the 1903 Cadillac, rated at six and one half horse power, could show so great a superiority over cars of much higher power. In reply we state that while we do not wish to suggest that other cars are rated higher than they test, we do know that one horse power with us means 33,000 actual foot pounds of work per minute; or in other words, the work necessary to lift a 33,000 pound weight one foot in one minute. We also know that no motor is put into a "Cadillac" car unless it will develop *more than its rated horse power.*

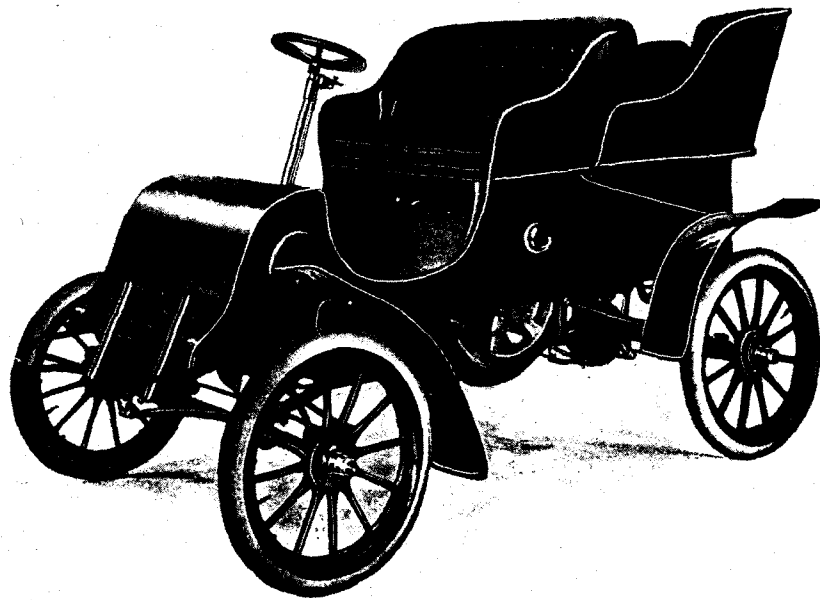

1904
**MODEL A. DETACHABLE
 TONNEAU**

SPECIFICATIONS

Tread 54½ inches
 Wheels 28 inches
 Tires 3 inches
 Heavy, Goodrich Double Tube, Detachable.
 Color Maroon
 With Black Trimmings.
 Gear Standard 9-38
 Options, 9-31, 9-34, 9-41.

Price, - \$850.00
 Net F. O. B. Detroit.

See Page 31 for Extras, Etc.

Member of Licensed Association of Automobile
 Manufacturers.

We do not mean to say, because the 1903 Cadillac won such popularity, that we lay claim to a *perfect* automobile. We do claim, however, that in the hands of our customers, our cars have demonstrated a "get there without trouble" quality, which has given us our present standing in the automobile world.

For 1904 we combine, with the advance in essential features which the 1903 cars represented, an equally progressive policy of improvement in all minor details. One of the most important of these minor improvements, is the introduction of a much more reliable and substantial electrical outfit than it has heretofore been possible to obtain.

An endless array of devices, good, bad and indifferent, have recently been designed to overcome the troubles arising from forgotten lubrication. Pumps, cams, check valves, relief valves, gears, chains, belts, etc., are being tried in the effort to produce an oiler that will feed when the engine runs, and stop when the engine stops. The Cadillac for 1904 is provided with a simplification instead of a complication. A switch combined with the oil feed in such a manner that when the oil is cut off the electric current is also off, and so arranged that *either* battery or *both* can be turned on, but not without turning on the oil feed as well.

By a perfectly automatic arrangement, the accumulation of any excess of lubricating oil in the combustion chamber is prevented, thereby making the motor more economical in the use of oil, at the same time assuring a more perfect cylinder lubrication than has ever before been obtained in any gasoline engine. This innovation prevents carbon deposits either in the

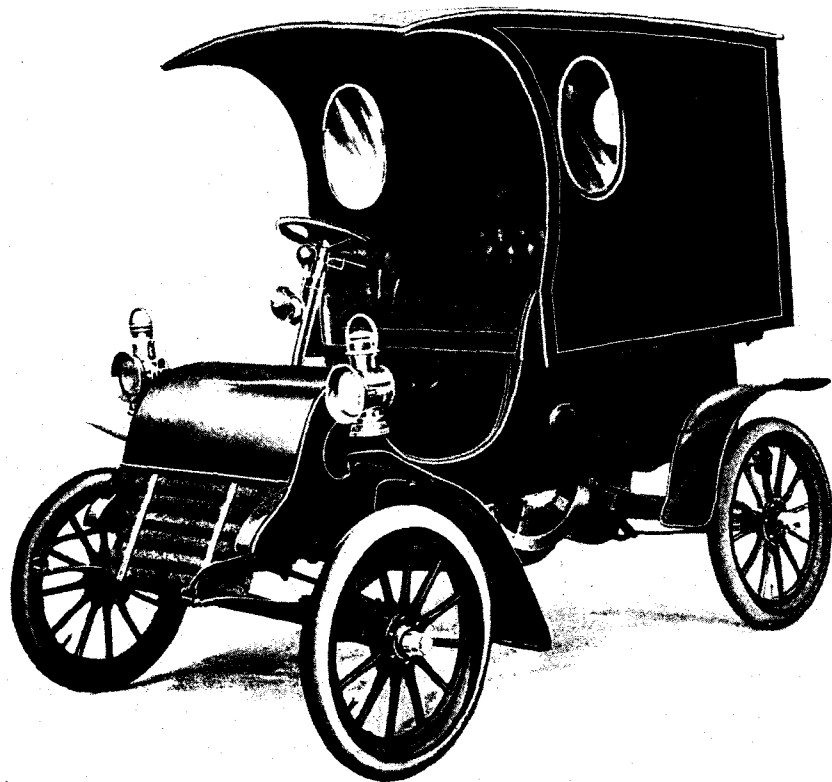

1904
MODEL A. DELIVERY

SPECIFICATIONS

Tread	54½ inches
Wheels	28 inches
Tires	3 inches
	Heavy, Goodrich Double Tube, Detachable.
Color	Maroon
	With Black Trimmings.
Gear	Standard 9-41

Price, - \$850.00
 Net F. O. B. Detroit.

See Page 31 for Extras, Etc.

Member of Licensed Association of Automobile
 Manufacturers.

combustion chamber or on the spark plug, thus insuring even greater satisfaction from our double insulated spark plugs, which have demonstrated a surprising superiority over all others, and have been used exclusively by customers, though we provide an arrangement whereby any plug can be substituted.

Other minor innovations in construction of 1904 Cadillacs are: a convenient extension of the arrangement for flushing the carburetor; an extension for one of the small grease cups which, though it needed only occasional attention, was rather unhandy to reach; improvements in the details of body construction, to prevent any possibility of rattling or soiling one's clothes; improved springs, brakes, tires, etc.

To anyone desiring a popular priced car, possessing all the essential features of the most expensive touring cars, we unhesitatingly recommend the Cadillac. It has been demonstrated to be a splendid hill climber, capable of taking four people anywhere that wheels can go, and as fast as ordinary roads will permit.

The automobile manufacturer who does not offer a liberal option on gears is as far behind the times as a bicycle manufacturer would be who attempted a similar policy. Our 1904 standard sprocket equipment is 9 and 38 teeth, with options on 9-31, 9-34 and 9-41.

The 9-31 combination we recommend only for runabouts on good roads. The 9-34 combination is all right for tonneau machines to be used on good roads and pavements. Both of these make fast machines, capable of thirty miles an hour or better when not overloaded.



1904
MODEL A. RUNABOUT
 WITH TOP

SPECIFICATIONS

Tread	54½ inches
Wheels	28 inches
Tires	3 inches
	Heavy, Goodrich Double Tube, Detachable.
Color	Maroon
	With Black Trimmings.
Gear	Standard 9-38
	Options, 9-31, 9-34, 9-41.
Price, {	Leather Top, complete, } \$800.00
	with Sides and Storm Apron. }
Price, {	Rubber Top, complete, } \$780.00
	with Sides and Storm Apron. }
	Net F. O. B. Detroit.

See Page 31 for Extras, Etc.

Member of Licensed Association of Automobile
 Manufacturers.

The standard 9-38 equipment is the best for all-around work, and will give a speed of twenty-five miles per hour where conditions are at all favorable.

For all delivery machines and such tonneau cars as are to be used on exceptionally bad roads, or in very hilly country, we recommend the 9-41 combination, which makes a car that will climb any grade of any traveled road.

The improvements, conveniences and options, referred to in this catalogue, combine to make the Cadillac automobile for 1904 the sturdiest, staunchest, most reliable car on the market, and all at a price which turned the automobile world topsy-turvy, just one year ago. To those who said the Cadillac was too much for the money and could not continue to be built for the price, we only state that after a year's experience we offer in the 1904 Model A Cadillac twenty-five per cent more value at the same price. This we are able to do by reason of our improved system and greatly increased facilities. We have demonstrated that a forty or fifty per cent better automobile, can be built and marketed at the same price, if the yearly output be several thousands instead of several hundreds—or just several.

When you buy, be sure YOU get the saving which necessarily results from manufacturing on a large scale.

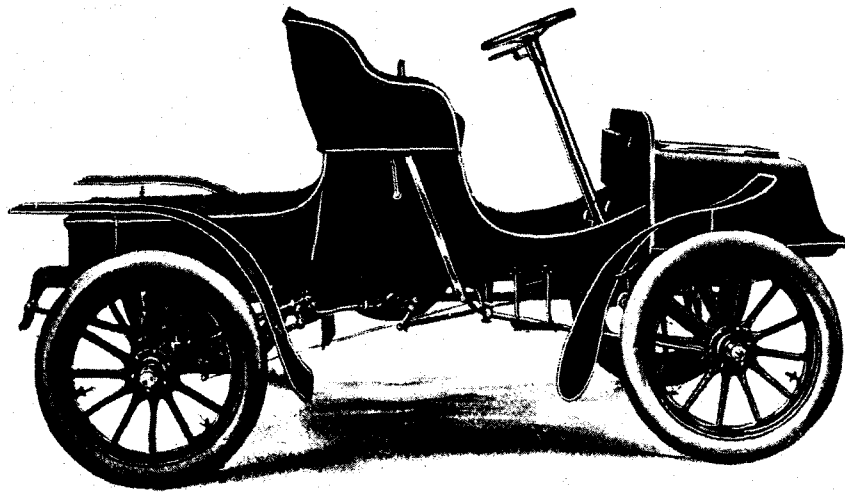

1904
MODEL B. RUNABOUT

SPECIFICATIONS

Tread 54½ inches
 Wheels 30 inches
 Tires 3 inches
 Heavy, Goodrich Double Tube, Detachable.
 Color Maroon
 With Black Trimmings.
 Gear Standard 10-38
 Options, 10-31, 10-34, 10-41.

Price, - \$800.00
 Net F. O. B. Detroit.

See Page 31 for Extras, Etc.

Member of Licensed Association of Automobile
 Manufacturers.

DURING the year 1903 we found a demand for a higher grade car than it was possible to build for the low price at which the Model A cars were sold. In answer to this demand we have broadened our line by the addition of the four cars shown on pages 12, 14, 16 and 18. These cars represent a long and logical step forward in the development of the automobile, and to appreciate fully the advance they represent, let us consider the automobile as a road locomotive.

The resistance due to soft roads is caused by the wheels imbedding themselves more or less in the surface, and by reason of this a light car has a great advantage over a heavy one. So great is this advantage that a 1200 pound car equipped with an eight horse power motor will travel American roads easier than a 2000 pound car having twenty horse power, although the ratio of weight to power is considerably in favor of the heavier one.

The result is that if eight or nine horse power can be put into a car weighing 1200 pounds, which at the same time combines ample strength and roomy, comfortable seating arrangements, we then have an automobile which suffers in comparison with the highest priced touring cars only on hard, level speedways, while the advantages of the light car are:—lower first cost, less cost of fuel, oil and repairs, **EQUAL SPEED** on ordinary roads, because the ordinary road

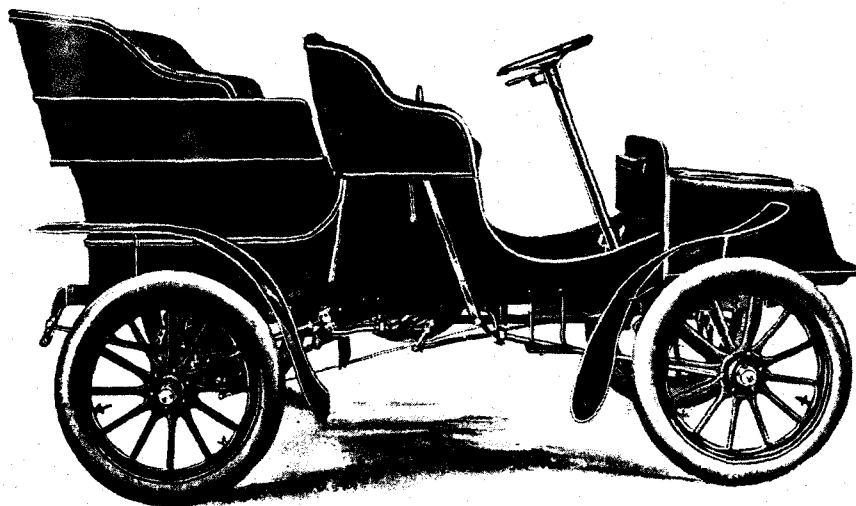

1904
MODEL B. TOURING CAR

SPECIFICATIONS

Tread	54½ inches
Wheels	30 inches
Tires	3 inches
	Heavy, Goodrich Double Tube, Detachable.
Color	Maroon
	With Black Trimmings.
Gear	Standard 10-45
	Options, 10-34, 10-38, 10-41.

Price, - \$900.00
Net F. O. B. Detroit.

See Page 31 for Extras, Etc.

Member of Licensed Association of Automobile
Manufacturers.

will not permit of a speed equal to the capacity of either machine, and GREATER ABILITY on roads that are at all soft or sandy.

Our Model B cars embody this well nigh perfect combination of roomy comfort in seating four passengers, great strength, sufficient for the hardest usage on typical American roads, long wheel base, soft springs, and are light enough to be perfectly handled by our eight and one quarter horse power motor.

The wonderful increase in value which this automobile presents over any other, either at or near its price, is only possible when manufactured in a perfectly systematized and equipped factory having a large output, for the reason that each piece must be made of special material, and with special tools to form it exactly proportionate to the strain and wear to which it is to be subjected. The preparation for the production of these parts dates back to the making of special grades of steel solely for the various parts of Cadillac automobiles, and it is only by such careful preparation that we are able to offer the really scientific construction shown in our Model B cars, which we believe to be as high a type of automobile as has ever been produced at ANY PRICE.

The Runabout, shown on page 12, may be geared up until it is capable of speed enough to satisfy the most reckless driver, and yet have ample power for the worst possible roadway.

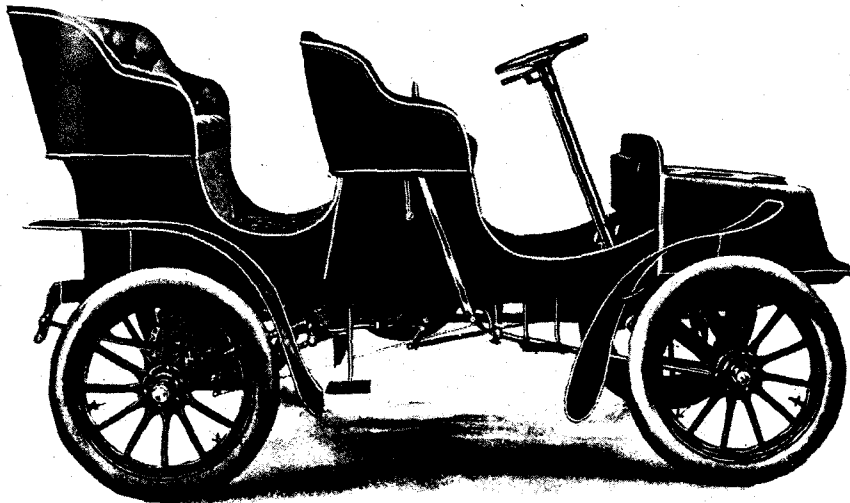

1904
MODEL B. SURREY

SPECIFICATIONS

Tread	54½ inches
Wheels	30 inches
Tires	3 inches
Heavy, Goodrich Double Tube, Detachable.	
Color	Maroon
With Black Trimmings.	
Gear	Standard 10-41
Options, 10-31, 10-34, 10-38.	

Price, - \$900.00
Net F. O. B. Detroit.

See Page 31 for Extras, Etc.

Member of Licensed Association of Automobile
Manufacturers.

The car shown on page 14, is a Touring Car in every sense of the word, being the simplest, safest, strongest, and most economical ever produced; one that will carry four passengers comfortably, and give a good account of itself on any road.

The Surrey, shown on page 16, is only another form of the touring car for those who prefer to get in and out at the side, instead of the rear.

The Delivery, page 18, just meets the requirements of the merchant who is tired of using three men and as many horses for the work that can be done better by one man and a Cadillac.

All the Model B Cadillacs have the bodies so arranged that they may be removed from the chassis simply by unscrewing the attaching screws and sliding the bodies back, without any lifting whatsoever. Then the chassis is a complete automobile to be tested, adjusted, or repaired with the most perfect accessibility possible.

In our Model B cars we continue the use of our single cylinder horizontal engine with a direct chain drive to the rear axle, because in all powers below eleven or twelve horse power this type of motor has everything to recommend it over any other style. The complication and multiplication of the parts necessary makes it impossible to build any other type of motor and maintain our high mechanical standard at anywhere near the same price. The question of

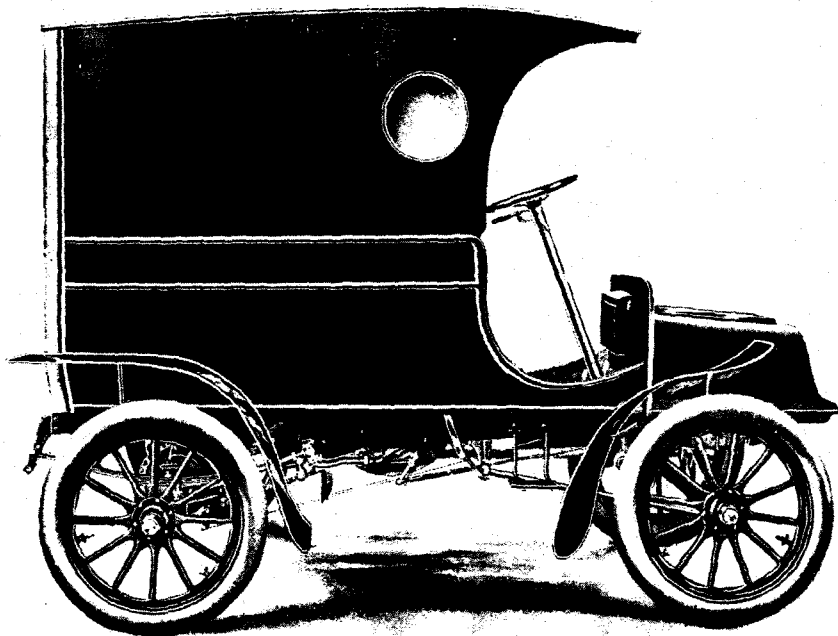

1904
MODEL B. DELIVERY

SPECIFICATIONS

Tread 54½ inches
 Wheels 30 inches
 Tires 3 inches
 Heavy, Goodrich Double Tube, Detachable.
 Color Maroon
 With Black Trimmings.
 Gear Standard 9-45

Price, - \$900.00

Net F. O. B. Detroit.

See Page 31 for Extras, Etc.

Member of Licensed Association of Automobile
 Manufacturers.

vibration is the only point that can be urged against the single cylinder engine, and since this, in a properly designed and balanced motor is difficult to detect, except when the car is standing still, it can hardly be seriously considered.

In a horizontal engine the direction of rotation should always be such that the side thrust of the piston on the working stroke is downward against the LOWER side of the cylinder, which is at all times coolest and best lubricated. In the two cylinder opposed type this is impossible in both cylinders, as one piston must get the side thrust on the working stroke upward against the TOP of the cylinder. This difficulty can only be met by giving that cylinder an excess of oil, necessarily causing carbon deposits in the combustion chamber, on the spark plugs, sticky exhaust valve stems and various other troubles that attend an excessive amount of lubricating oil in the cylinder.

The NOVICE is sometimes told that if he has a two cylinder engine he can always depend on one of them to "bring him home" if the other fails, but one should remember that the one live cylinder has no small load to carry to work the dead one, besides having a fly wheel too light for impulses coming only half as often as they should.

If you want to be sure of getting back, have ONE cylinder — MADE RIGHT; in other words, buy a CADILLAC.

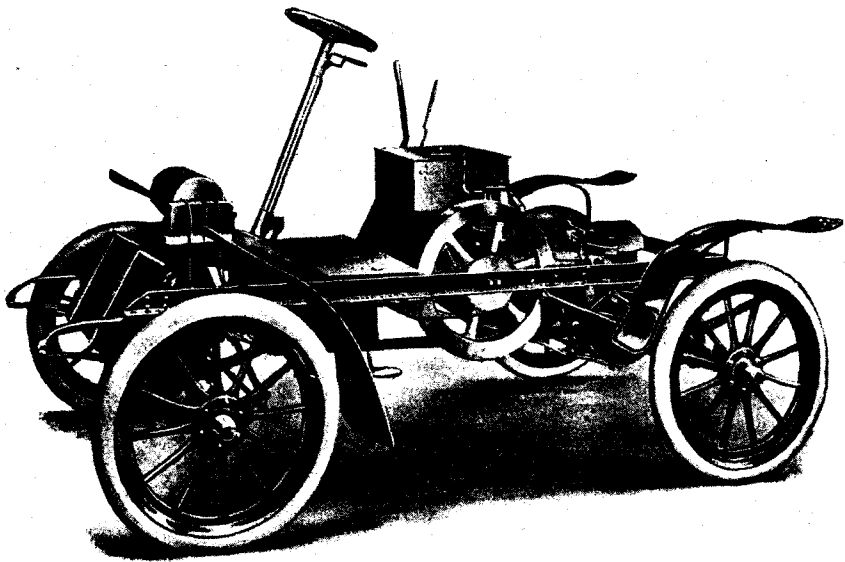

1904
MODEL A. CHASSIS

Is used interchangeably under all Model A Cadillacs. Bodies can be quickly removed or changed without disturbing the working parts in any way.

SPECIFICATIONS

Frame—angle iron, with drop forged outriggers and spring hangers, all hot riveted in place.

Best improved heavy 1904 model, Whitney roller chain, 1 inch pitch.

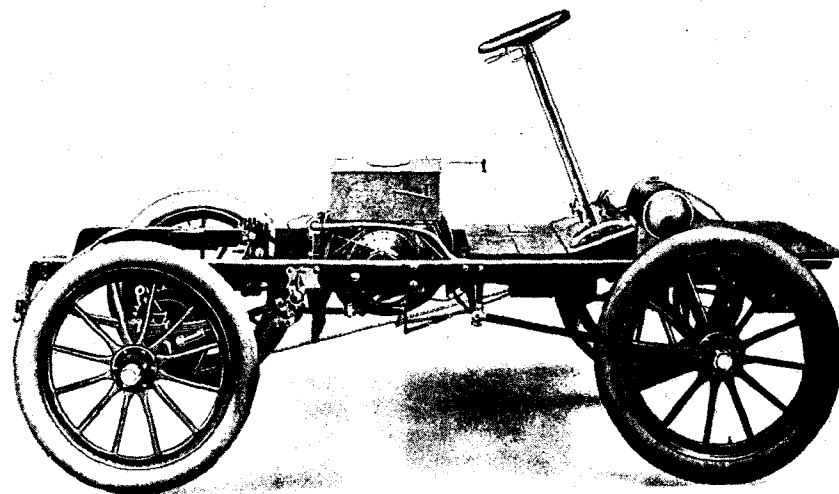

1904
MODEL B. CHASSIS

Is used under all Model B cars. All bodies can be quickly removed *without lifting* and without disturbing any of the working parts.

SPECIFICATIONS

Frame—cold rolled pressed steel with outriggers and spring hangers, drop forged and hot riveted in place.

Three spring suspension, giving absolute flexibility.

Best improved heavy 1904 model, Whitney roller chain, 1 inch pitch.

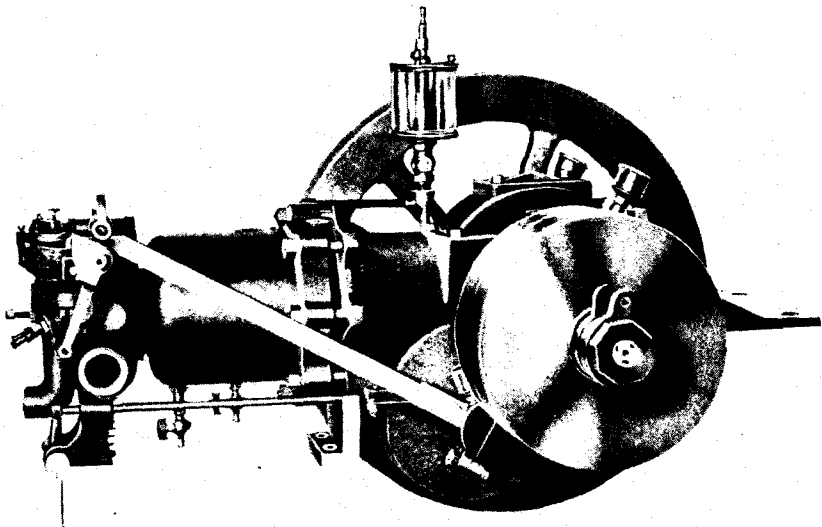

CADILLAC MOTOR

In the little Hercules, illustrated above, we have followed the policy of true progress — we started with a good thing and made it better. The usual method is to start with any NEW thing, sell all that is possible by reason of its NEWNESS, then try another.

After a year's experience, we know just where we are at, and our PROGRESS has been along the lines of MORE strength with LESS weight in the rest of the car; MORE power from the SAME engine; and we can, with absolute honesty, rate the motor for the 1904 Cadillac cars, both Models A and B, at 8¼ horse power.

To our unexpectedly large number of lady drivers we wish to state that this year's motor is provided with a compression relief, which makes starting mere play for the most delicate wrist.

The absolute interchangeability of EVERY wearing surface on the motor will be maintained as heretofore for no motor can honestly be termed first-class without this provision against expensive repairs in case of accidental neglect.

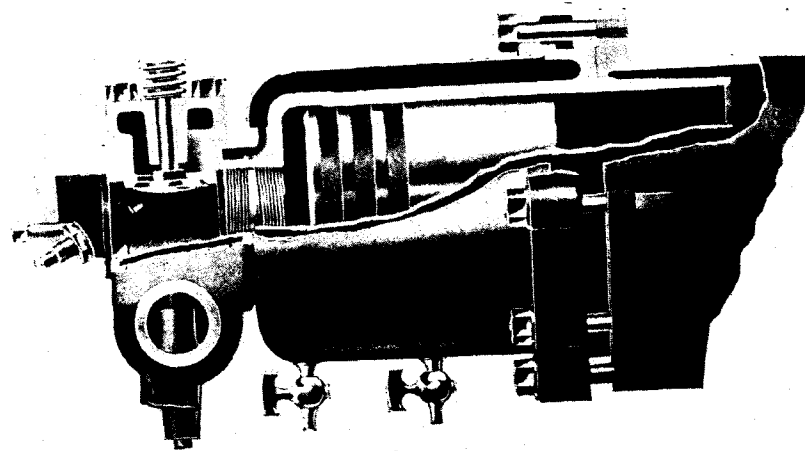

WATER JACKET

A year's experience with our copper water jacket has made our agents and customers pronounce it the ONLY practical system of jacketing.

It has no gaskets to burn, soak, or blow out; no leaded joints to melt out; no intricate coring on the cylinder, consequently no unexpected defects showing up; neither does a little neglect cost the inexperienced user a small fortune for a new cylinder.

These details mean little or nothing to the novice or the driver of a Cadillac, but they do mean something to the user of some other form of construction, who, perchance has left his machine forty miles from home and then sent a mechanic out to put in a new cylinder gasket. They mean something also to the chauffer who may have tried to start his motor with a defective gasket which was leaking water into the combustion chamber.

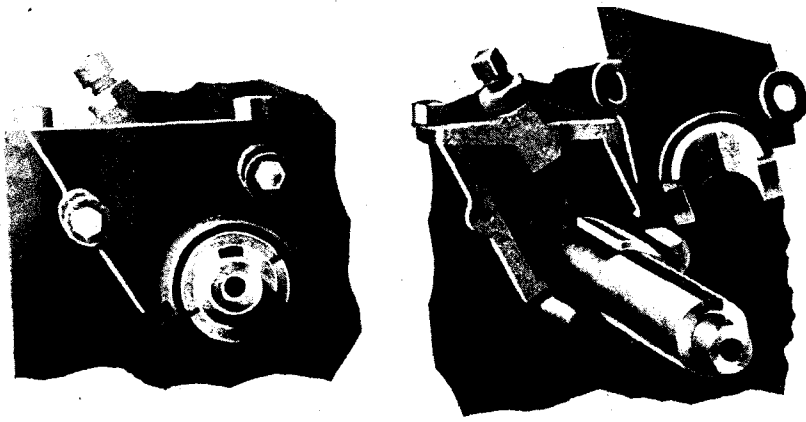

SHAFT BEARINGS

These two cuts are self-explanatory, showing how the main shaft bearings may be interchanged without removing the shaft from the motor.

This is a fine illustration of the thoroughness with which the details of the Cadillac motor have been worked out.

In most automobiles these bearings are usually made by casting babbitt metal into the frame of the engine, which means, of course, that if a bearing is allowed to cut, the motor must be returned to the factory if any PROPER repair is to be made.

In the Cadillac, however, the babbitt facing is backed by a finished piece of bronze, which fits the frame of the engine and the bearing cap in such a way that a bearing may be replaced in a few minutes, and the alignment of the shaft will be as good as when the motor was new.

The system of making these bearings also permits the babbitt facings to be COMPRESSED, thereby making them much more durable than when simply CAST in place.

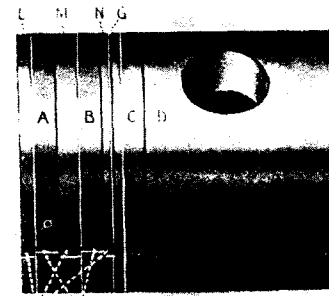

FIG. 1.

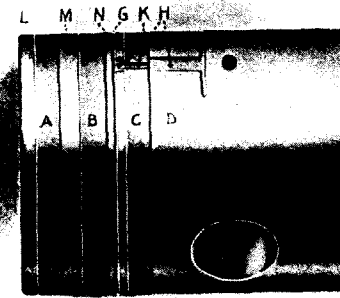

FIG. 2.

PISTON

Without the addition of one single part, we present the first and only arrangement that prevents the accumulation of any excess of lubricating oil in the combustion chamber and at the same time INSURES perfect piston lubrication.

In Fig. 1 (the BOTTOM of piston) the junk rings L, M and N, and the first two packing rings, A and B, are grooved, forming a passage to the circular groove G, which continues around the junk ring, N, connecting with the grooves H and K (on TOP of the piston), Fig. 2, thus forming a passage past the third packing ring, C.

The result is, that any excess of oil on the lower part of the cylinder wall is FORCED into the circular groove around each side of the piston and out on the top, thereby encircling the piston with a ring of oil in the groove, G.

The passage is too small to produce any loss of power whatsoever, but maintains the most perfect lubrication possible at all points in the cylinder, USING the oil that usually causes all kinds of trouble.

CADILLAC TRANSMISSION

The Cadillac transmission combines strength, durability, quietness and requires the least possible attention, which are virtues not possessed by any other gear.

The driving gear, D, is the only part attached to the engine shaft. When assembled, the cover, C, and case, H, form an oil reservoir enclosing all the working parts, thus insuring the best possible lubrication with the least attention. It has but ONE oil hole instead of the usual 10 or 12, and will hold enough oil for SEVERAL DAYS of the hardest use.

If the case, H, be held by its brake band when driving gear is rotating, all the gears in the case, except B, run at the same speed as the engine shaft, *but no faster*. The gear, B, and with it the driving sprocket, A, runs at a lower speed, but in the opposite direction, thus producing the reverse. If the case be allowed to revolve, and the drum, K, be held by its brake, all the gears run at much lower speed than the engine shaft, driving internal gear, B, around slowly forward, producing the slow speed. If brake drum, K, be locked to shaft by the high speed clutch, the whole gear revolves and acts as an additional fly-wheel.

By driving through gear, B, and engaging at three points, the lowest possible tooth strains are secured. All the gears are large; none of them can ever run as fast as the engine except in backing. These strong points of advantage form a combination of virtues never before secured in any transmission and make the Cadillac transmission the IDEAL GEAR for its duty.

Remember that the Cadillac transmission has none of the following defects, some of which are found in all other gears: several points to oil; high tooth strains; weak toothed pinions, running at several times the engine speed; short, inadequate bearings. In plain words, the Cadillac gear is made RIGHT.

CADILLAC SPARK PLUG

Our double insulated spark plug, illustrated opposite, needs no further explanation or recommendation.

It allows the secondary current to be kept separate from the rest of the mechanism.

Ask a coil maker if it is right; or a customer how it works.

We provide for the use of ANY plug desired, but last year our own special plug was ALWAYS used.

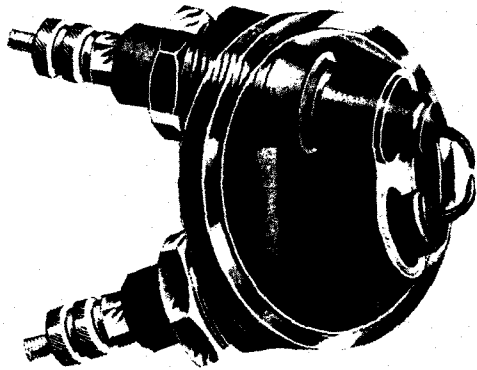
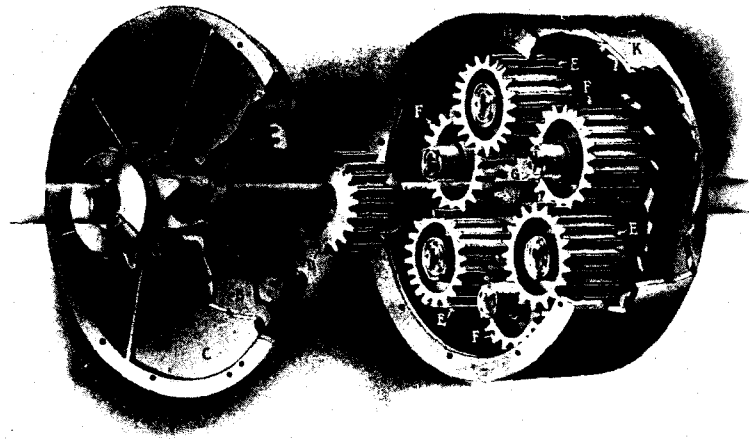

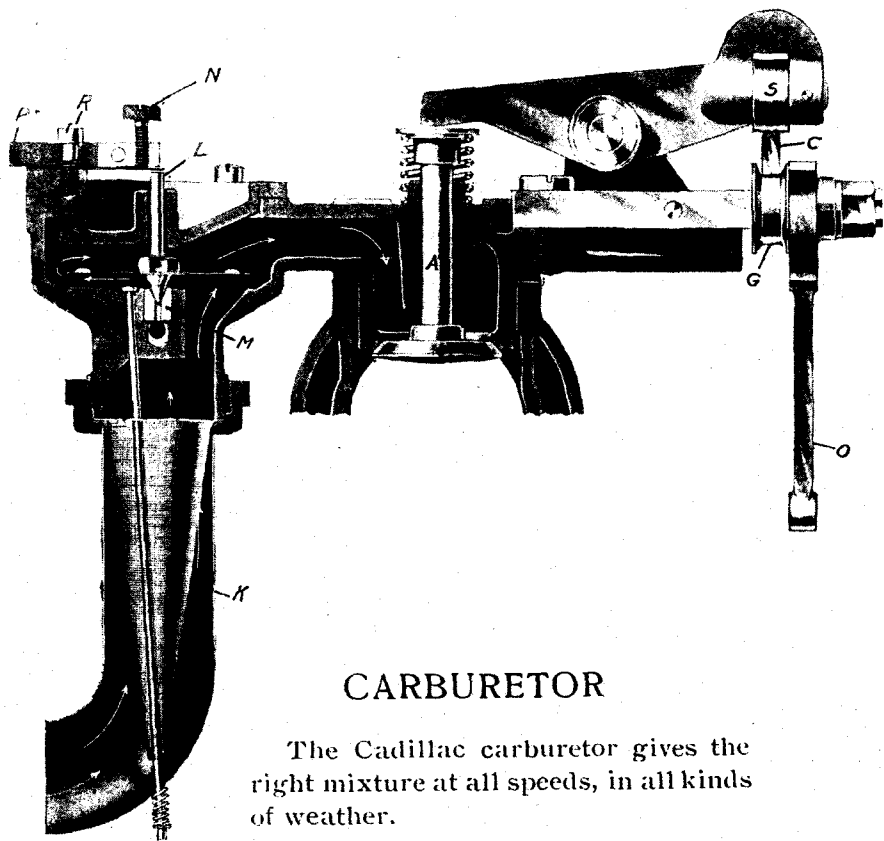

CARBURETOR

The Cadillac carburetor gives the right mixture at all speeds, in all kinds of weather.

It gives the proper mixture for starting with such certainty, that in the engine factory testing department no starting crank or device of any kind is ever used.

Of course this carburetor can get clogged by dirty fuel, the same as any other, but unlike the others, it can be taken apart, cleaned and put together in a few minutes without even changing the adjustment.

Having no bothersome float, it is not affected by changes of altitude, steep grades, sharp corners, or sudden starting or stopping.

It will work tipped at an angle of 30° or 40°, as well as on the level.

It is the RIGHT kind of a carburetor.

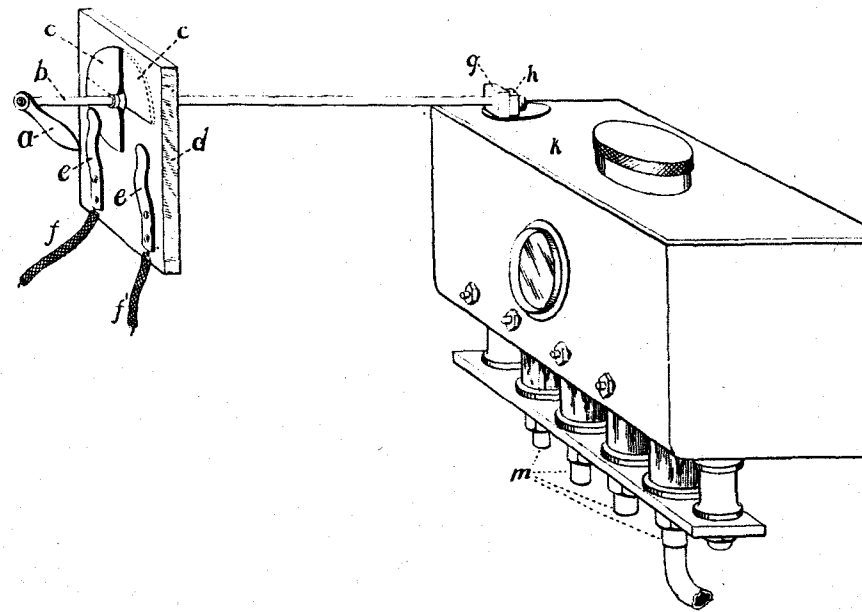

OIL AND SWITCH SYSTEM

A novel switch arrangement is shown in the illustration above. It prevents the oil feed from being forgotten by making the handle, A, which turns the oil on or off also turn the electric current on and off.

As shown in the cut, the battery connected to the wire, F, is in operation and the oil is turned on; if the handle, A, be turned down, the half disc, C, does not make a connection with either battery, neither is the oil turned on; if the handle, A, be turned horizontally in the opposite direction to that shown in the cut, the battery connected with wire, F¹, becomes operative; in case the batteries become weak, the handle, A, may be turned directly up, thus connecting BOTH batteries.

This 1904 device is simple and positive in its action. With it you cannot start your motor without turning on the oil. You cannot stop the motor and leave the oil feeding.

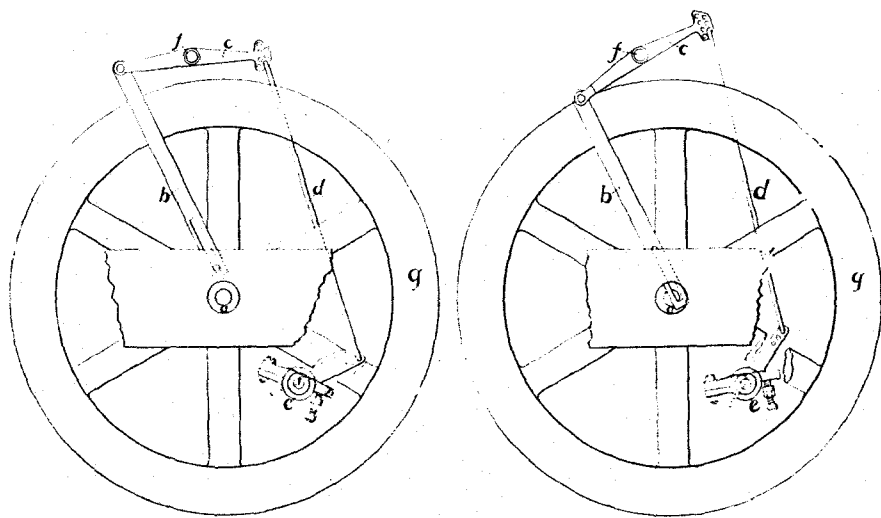

FIG. 1

FIG. 2

SAFETY STARTING DEVICE

A glance at the two illustrations above will give a comprehensive understanding of the safety starting device, which will be used on all Model B Cadillac Automobiles.

The starting crank can only be inserted when the commutator, E, is in the position shown in Fig. 1 which gives the late ignition for starting, thereby absolutely preventing any chance of accident from trying to start with the ignition set EARLY.

PRICE LIST OF EXTRAS AND GENERAL OUTFIT INFORMATION

When Runabouts are ordered without tops, which purchasers expect to require later, the seats must be ordered "Ironed for Top" and the list price will be increased \$5.00. This is indispensable, as seats cannot be ironed after the upholstering is done. When top is purchased, allowance for ironing will be made.

When automobiles are to be shipped singly long distances, it is advisable to have them crated. Cost of crating is extra, \$10.00 net.

Where purchasers of Model B Touring Cars or Surreys want to use them as Runabouts, decks will be furnished at an extra cost of \$10.00 each.

A full equipment of tools, also tire pump and repair kit is furnished with each automobile, but we do not furnish lamps or horns except as extras.

A complete price list of Cadillac automobile parts will be mailed to any purchaser upon application.

GUARANTEE

The guarantee of the National Association of Automobile Manufacturers covers CADILLAC Automobiles. Parts that we decide are defective will be replaced at our factory, provided they are sent us charges prepaid.

All tires used on CADILLAC Automobiles are guaranteed by the tire manufacturers and should be sent direct to them, transportation charges prepaid.

Goodrich G. & J. Clincher Tires are standard equipment and should be sent to the nearest of the following branch houses of the B. F. Goodrich Co.:

New York City, 66-68 Reade St.	Detroit, 80 E. Congress St.
New York City, 1625 Broadway.	Akron, Ohio.
Chicago, 141 Lake St.	Buffalo, 9 W. Huron St.
Philadelphia, 922 Arch St.	Denver, 1444 Curtis St.
Boston, 157 Summer St.	Cleveland, Superior St.
San Francisco, 392 Mission St.	London, Eng., 7 Snow Hill, E. C.

CADILLAC AUTOMOBILE DEALERS

ALABAMA—Birmingham White-Blakeslee Mfg. Co.
 ARKANSAS—Little Rock Arkansas Auto. Co.
 CALIFORNIA—San Francisco Cuyler M. Lee
 " —Los Angeles Norman W. Church
 COLORADO—Denver Colorado Auto. Co.
 CONNECTICUT—Hartford Brown, Thomson & Co.
 " —New Haven The Holcomb Co.
 " —Middletown Caulkins & Post
 " —Stamford Mechaley Bros.
 " —Bridgeport Bridgeport Cycle Co.
 " —South Norwalk H. R. Buckley & Co.
 DELAWARE—Wilmington T. C. Bradford
 DISTRICT OF COLUMBIA—Washington Pope Mfg. Co.
 FLORIDA—Daytona W. E. French
 " —Tampa Tampa Cycle Co.
 GEORGIA—Atlanta L. E. Fain
 " —Macon J. W. Shinholser & Co.
 ILLINOIS—Chicago Cadillac Co. of Illinois
 " —Harvard 3 Manley Bros.
 INDIANA—Indianapolis Indiana Automobile Co.
 " —Muncie C. S. Wachtell & Son Co.
 IOWA—Des Moines W. J. Riddell
 KENTUCKY—Louisville Motor Vehicle Co.
 LOUISIANA—New Orleans Automobile Co., Ltd.
 MARYLAND—Baltimore Mar-Del Mobile Co.
 MASSACHUSETTS—Boston Pope Mfg. Co.
 " —Fitchburg Iver Johnson Sporting Goods Co.
 " —Springfield Adolf A. Geisel
 " —Worcester Birney A. Robinson
 MICHIGAN—Detroit William E. Metzger
 " —Bay City F. H. Fenner
 " —Grand Rapids Michigan Auto. Co.
 " —Menominee D. F. Poyer
 MINNESOTA—Minneapolis Pence Automobile Co.
 MISSOURI—Kansas City The Automobile Co.
 " —St. Louis Halsey Automobile Co.
 NEBRASKA—Omaha Anderson-Millard Co.
 NEW JERSEY—Jersey City Crescent Auto. Co.
 " —Newark Motor Car Co. of N. J.
 " —Summit Chester C. Henry
 NEW YORK—New York City Cadillac Co. of N. Y.
 " —Albany and Troy James Lucey
 " —Buffalo Centaur Motor Co.
 " —Rochester Fred. A. Mabbett
 NORTH CAROLINA—Durham George Lyon
 " —Wilmington Caro. Auto. & Bicycle Co.
 NORTH DAKOTA—Grand Forks Houghton Implement Co.
 OHIO—Cleveland Ohio Motor Car Co.
 " —Cincinnati Hanauer Auto. Co.
 " —Dayton Peckham Carriage Co.
 " —Toledo Lichtie Auto. Co.
 OREGON—Portland Lee Automobile Co.
 PENNSYLVANIA—Erie Jacob Roth
 " —Allentown O. H. Dietrich Co.
 " —Harrisburg Central Pa. Auto. Co.
 " —Hazleton Hazleton Machinery & Supply Co.
 " —Philadelphia Pa. Electric Vehicle Co.
 " —Pittsburg Banker Bros.
 RHODE ISLAND—Providence Pope Mfg. Co.
 TENNESSEE—Knoxville Schultz-Howard Co.
 TEXAS—Dallas Parlin-Orendorff Co.
 " —San Antonio Staacke Bros.
 " —El Paso El Paso Auto. Co.
 VERMONT—Barre Standard Electric Co.
 VIRGINIA—Richmond Foster & Foster
 WISCONSIN—Milwaukee Theo. Jonas