

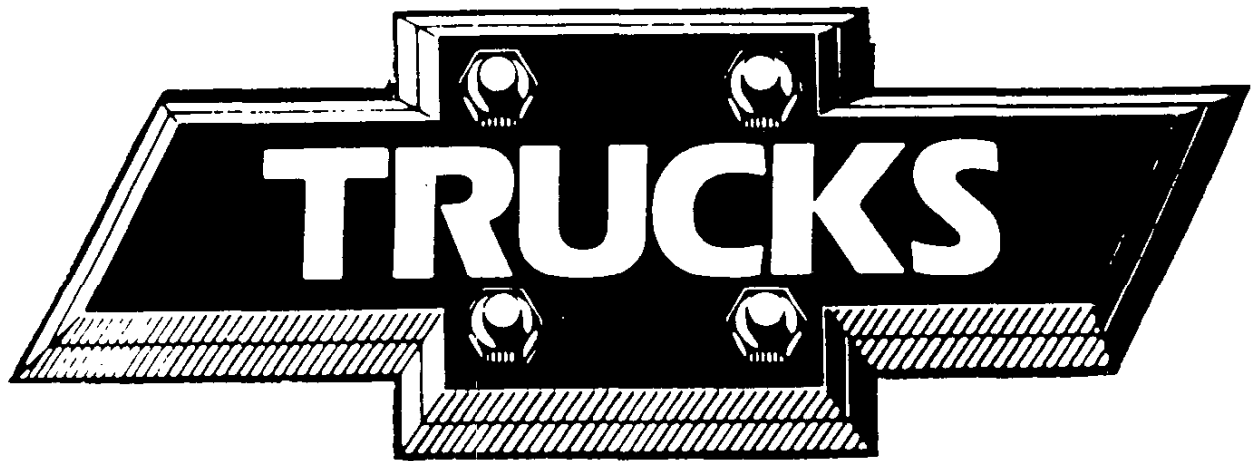

CHEVROLET



1996

C/K PICKUP INTRODUCTION

C/K PICKUP

The 1996 C/K Pickups are available in two trim levels: the "Cheyenne" (standard) and the "Silverado" (uplevel).

Changes on the C/K Pickup for 1996 include:

A new lineup of gasoline engines including the Vortec 4300, 5000, 5700 and 7400 engines. While driving down the road, your customers will experience the benefits of these new engines in the following areas:

- **Increased Performance**—These engines produce up to 30% more horsepower and 10% more torque over an extended operating range compared to last year's engines. Some of the internal changes that make this possible include:

- Sequential fuel injection for a more precise air/fuel mixture
- High-flow cylinder heads for improved air intake and exhaust flow
- Higher compression ratio
- New camshaft and roller lifters

An example of the increased power of these engines is the Vortec 5000 V8 engine. For 1996, this new engine is rated at 220 horsepower. Not only is this 45 horsepower greater than the old 5.0L V8 it replaces but it is also 20 more horsepower than last year's 5.7L V8 engine

- **Increased Pleasability**—These engines start quicker, accelerate faster, provide heat faster, idle smoother and run quieter. Some of the design changes that make this possible include:
 - Composite front cover, remote air cleaner and intake manifold for reduced noise
 - Stiffer accessory drive and powertrain for reduced noise and vibration
 - Sequential fuel injection for smoother idle and quick starts

- Controlled by-pass thermostat for quicker available interior heat
- Increased low-end torque to get loads moving faster
- Redesigned engine mounts and brackets for reduced vibration
- **Reduced Maintenance**—Service intervals have been extended for changing spark plugs, replacing engine coolant and checking ignition timing, accessory drive belts and the PCV valve. Some of the factors involved in this are:
 - Platinum-tip spark plugs for extended wear
 - Crankshaft and camshaft sensors
 - Improved seals
 - Extended-life engine coolant (DEX-COOL™)
 - Aluminized stainless steel exhaust system for extended wear
- **Increased Emissions Compliance**—On Board Diagnostics II (OBD II) provides early detection and diagnosis of potential problems. This is possible due to:
 - Air temperature sensors at the crankshaft, camshaft and manifolds
 - Sequential fuel injection to help reduce exhaust emissions
 - Vehicle Control Module for earlier detection and diagnosis of potential problems
 - Improved combustion chamber to reduce emissions

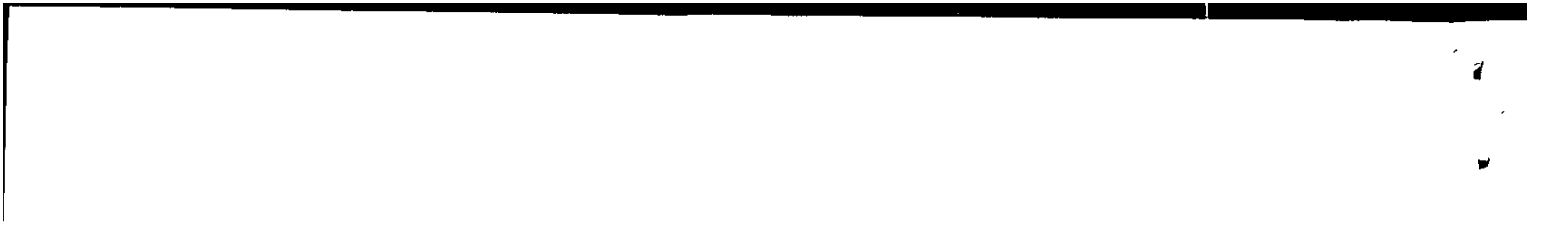

C/K PICKUP INTRODUCTION

C/K PICKUP

Changes on the C/K Pickup for 1996 (continued)

- Optional Electric Shift Transfer Case (NP1) 1500/2500 Series only
 - Optional Rear-Seat Easy Access System on C/K 10753 Extended-Cabs (E24—Interim Availability)
 - New Front Bench Seat Armrest Stowage Compartment with bench seats on uplevel trim YE9 Silverado. Includes a coin holder, a map net and a writing board
 - Optional Electrochromic Interior Rearview Mirror with 8-point compass (DD7)
 - Revised 5-speed Manual Transmission (M50); includes reduced first gear ratio—3.49:1
 - 4-speed 4L60-E Automatic Transmission enhancements (M30)
 - 4-speed 4L80-E Automatic Transmission enhancements (MT1)
 - New P-Metric Tires now available on K1500 models
 - Two Auxiliary Power Outlets with spring-loaded doors
 - Standard Daytime Running Lamps
 - Standard Illuminated Entry
 - Standard DEX-COOL™ Extended-Life Engine Coolant. Coolant color is fluorescent orange and the change interval is now 5 years/100,000 miles
 - Rear-Seat Heat Ducts on Crew-Cab models
 - One new Interior Color
 - One new Exterior Color
 - New Underhood Storage Compartment
-



C/K PICKUP

MODEL SELECTION SUMMARY

Use the chart below to choose the model that fits your customer's needs. Please note that the Base Payloads shown reflect the maximum allowable weight of cargo that can be carried in a standard model, including occupants. (They are calculated by subtracting curb weight from the GVWR.) To calculate payloads for models with optional equipment, please refer to the WEIGHTS section in the back of this book or consult your 1996 GM PROSPEC. Also, the Maximum Trailer Weights shown below are based on vehicles that are properly equipped. See your Chevrolet Truck Order Guide for specific details.

SERIES	MODEL NUMBER/ BODY CODE/ OPTION CODE	PASSENGER CAPACITY (STD/OPT.)	STANDARD ENGINE/ TRANS.	OPTIONAL ENGINE/ TRANS.	GVWR (LB)	GAWR (LB) FRONT/ REAR	BASE PAYLOAD (LB)	MAXIMUM TRAILER WT./ TONGUE LOAD (LB) PROPERLY EQUIPPED	MAXIMUM TRAILER WT. KINGPIN LOAD (LB) PROPERLY EQUIPPED
TWO-WHEEL-DRIVE MODELS									
C1500 REGULAR-CAB									
SPORTSIDE SHORT-BOX	CC10703/E62	3/2	4300 V6/M5	4300 V6/A4 5000 V8/M5/A4 5700 V8/M5/A4	6100	3150/3686	W/A	5000/600 6000/750 7500/900	• • •
FLEETSIDE SHORT-BOX WT 1500	CC10703/E63/ X81	3/-	4300 V6/M5	4300 V6/A4	6100	3150/3686	W/A	5000/600	•
FLEETSIDE SHORT-BOX	CC10703/E63	3/2	4300 V6/M5	4300 V6/A4 5000 V8/M5/A4 5700 V8/M5/A4	6100	3150/3686	2269	5000/600 6000/750 7500/900	• • •
FLEETSIDE LONG-BOX WT 1500	CC10903/E63/ X81	3/-	4300 V6/M5	4300 V6/A4	6100	3150/3686	W/A	5000/600	•
FLEETSIDE LONG-BOX	CC10903/E63	3/2	4300 V6/M5	4300 V6/A4 5000 V8/M5/A4 5700 V8/M5/A4 6.5L V8/A4	6100	3150/3686	2110	5000/600 6000/750 7500/900 7000/850	• • • •
C1500 EXTENDED-CAB									
SPORTSIDE SHORT-BOX	CC10753/E62	6/5/3	4300 V6/M5	4300 V6/A4 5000 V8/M5/A4 5700 V8/M5/A4 6.5L V8/A4	6200	3500/3686	W/A	5000/600 6000/750 7500/900 7000/850	• • • •
FLEETSIDE SHORT-BOX	CC10753/E63	6/5/3	4300 V6/M5	4300 V6/A4 5000 V8/M5/A4 5700 V8/M5/A4 6.5L V8/A4	6200	3500/3686	2079	5000/600 6000/750 7500/900 7000/850	• • • •
FLEETSIDE LONG-BOX	CC10953/E63	6/5/3	5000 V8/M5	5000 V8/A4 5700 V8/M5/A4 6.5L V8/A4	6200	3500/3686	1840	6000/750 7500/900 7000/850	• • •
C2500 REGULAR-CAB									
FLEETSIDE LONG-BOX	CC20903/E63	3/2	5000 V8/M5	5000 V8/A4 5700 V8/M5/A4 6.5L V8/A4	7200 7200	3150/4670 3400/4670	2931	6500/800 8000/950 7500/900	6500/2000 7000/2000 7500/1600
FLEETSIDE LONG-BOX HD	CC20903/E63/ C6P/ YHH or YGK	3/2	5700 V8/M5	5700 V8/A4 6.5L V8/M5/A4	8600	3600/8000	W/A	8000/950 8500/1000	8000/3000 8500/2500

See the following pages for additional 2- and 4-Wheel-Drive Models.
 *5th-wheel trailering is not recommended.
 W/A-Will Advise. Please refer to Weights in back of Tech Guide for optional payloads.



2
2



C/K PICKUP

SERIES	MODEL NUMBER/ BODY CODE/ OPTION CODE	PASSENGER CAPACITY (STD./OPT.)	STANDARD ENGINE/ TRANS.	OPTIONAL ENGINE/ TRANS.	GVWR (LB)	GAWR (LB) FRONT/ REAR	BASE PAYLOAD (LB)	MAXIMUM TRAILER WT./ TONGUE LOAD (LB) PROPERLY EQUIPPED	MAXIMUM TRAILER WT./ KINGPIN LOAD (LB) PROPERLY EQUIPPED
TWO-WHEEL-DRIVE MODELS (CONT.)									
C2500 EXTENDED-CAB									
FLEETSIDE SHORT-BOX	CC20753/E63	6/5/3	5000 V8/M5	5000 V8/A4 5700 V8/M5/A4 6.5L V8/A4	7200	3600/4670	2800	6500/800 7000/850 7500/900	6500/2000 7000/2000 7500/1600
FLEETSIDE LONG-BOX HD	CC20953/E63/ C6P/ YHH or YGK	6/5/3	5700 V8/M5	5700 V8/A4 6.5L V8/M5/A4	8600	3600/6000	W/A	8000/950 8500/1000	8000/3000 8500/2500
C3500 REGULAR-CAB									
FLEETSIDE LONG-BOX	CC30903/E63 YGK or YHH	3/2	5700 V8/M5	5700 V8/A4 7400 V8/M5/A4 6.5L V8/M5/A4	9000	3600/6084	+198	9500/1000 10000/1000 8500/1000	8000/3000 11000/3000 8500/3000
FLEETSIDE LONG-BOX DUAL-REAR-WHEELS	CC30903/E63/ R05	3/2	5700 V8/M5	5700 V8/A4 7400 V8/M5/A4 6.5L V8/M5/A4	10000	3600/7500	W/A	9500/1000 10000/1000 8500/1000	9500/3000 13000/3000 8500/3000
C3500 EXTENDED-CAB									
FLEETSIDE LONG-BOX DUAL-REAR-WHEELS	CC30953/E63/ R05	6/5/3	5700 V8/M5	5700 V8/A4 7400 V8/M5/A4 6.5L V8/M5/A4	10000	3600/7500	W/A	9500/1000 10000/1000 8500/1000	9500/3000 13000/3000 8500/3000
C3500 CREW-CAB									
SINGLE REAR WHEELS	CC30943/E63	6/5	5700 V8/M5	5700 V8/A4 7400 V8/M5/A4 6.5L V8/M5/A4	9000	4100/6084	3525	9000/1000 10000/1000 8000/950	9500/3000 12500/3000 8000/3000
DUAL-REAR-WHEELS	CC30943/E63/ R05	6/5	5700 V8/M5	5700 V8/A4 7400 V8/M5/A4 6.5L V8/M5/A4	10000	4100/7500	W/A	9000/1000 10000/1000 8000/950	9000/3000 12500/3000 8000/3000

See the following pages for 4-Wheel-Drive Models.
W/A-Will Advise. Please refer to Weights in back of Tech Guide for optional payloads.



C/K PICKUP

SERIES	MODEL NUMBER/ BODY CODE/ OPTION CODE	PASSENGER CAPACITY (STD./OPT.)	STANDARD ENGINE/ TRANS.	OPTIONAL ENGINE/ TRANS.	GVWR (LB)	GAWR (LB) FRONT/ REAR	BASE PAYLOAD (LB)	MAXIMUM TRAILER WT./ TONGUE LOAD (LB) PROPERLY EQUIPPED	MAXIMUM TRAILER WT./ KINGPIN LOAD (LB) PROPERLY EQUIPPED
FOUR-WHEEL-DRIVE MODELS									
K1500 REGULAR-CAB									
SPORTSIDE SHORT-BOX	CK10703/E62	3/2	4300 V6/M5	4300 V6/A4 5000 V8/M5/A4 5700 V8/M5/A4	6100	3600/3750	W/A	5000/600 6500/800 7000/850	* * *
FLEETSIDE SHORT-BOX WT 1500	CK10703/E63/ X81	3/-	4300 V6/M5	4300 V6/A4	6100	3600/3750	W/A	5000/600	*
FLEETSIDE SHORT-BOX	CK10703/E63	3/2	4300 V6/M5	4300 V6/A4 5000 V8/M5/A4 5700 V8/M5/A4	6100	3600/3750	1828	5000/600 6500/800 7000/850	* * *
FLEETSIDE LONG-BOX WT1500	CK10903/E63/ X81	3/-	4300 V6/M5	4300 V6/A4	6100	3600/3750	W/A	5000/600	*
FLEETSIDE LONG-BOX	CK10903/E63	3/2	4300 V6/M5	4300 V6/A4 5000 V8/M5/A4 5700 V8/M5/A4 6.5L V8/A4	6100	3600/3750	1679	5000/600 6500/800 7000/850 7500/900	* * * *
K1500 EXTENDED-CAB									
SPORTSIDE SHORT-BOX	CK10753/E62	6/5/3	4300 V6/M5	4300 V6/A4 5000 V8/M5/A4 5700 V8/M5/A4	6200	3600/3750	W/A	5000/600 6500/800 7000/850	* * *
SPORTSIDE SHORT-BOX	CK10753/E62/ F44	6/5/3	4300 V6/M5	4300 V6/A4 5000 V8/M5/A4 5700 V8/M5/A4 6.5L V8/A4	6600	3600/3750	W/A	5000/600 6500/800 7000/850 7500/900	* * * *
FLEETSIDE SHORT-BOX	CK10753/E63	6/5/3	4300 V6/M5	4300 V6/A4 5000 V8/M5/A4 5700 V8/M5/A4	6200	3600/3750	1711	5000/600 6500/800 7000/850	* * *
FLEETSIDE SHORT-BOX	CK10753/E63/ F44	6/5/3	4300 V6/M5	4300 V6/A4 5000 V8/M5/A4 5700 V8/M5/A4 6.5L V8/A4	6600	3600/3750	W/A	5000/600 6500/800 7000/850 7500/900	* * * *
FLEETSIDE LONG-BOX	CK10953/E63	6/5/3	5000 V8/M5	5000 V8/A4 5700 V8/M5/A4	6200	3600/3750	1719	6500/800 7000/850	* *
FLEETSIDE LONG-BOX	CK10953/E63/ F44	6/5/3	5000 V8/M5	5000 V8/A4 5700 V8/M5/A4 6.5L V8/A4	6600 6800	3600/3750	W/A	6500/800 7000/850 7500/900	* * *

*5th-wheel trailering is not recommended.

W/A-Will Advise. Please refer to Weights in back of Tech Guide for optional payloads.



C/K PICKUP

SERIES	MODEL NUMBER/ BODY CODE/ OPTION CODE	PASSENGER CAPACITY (STD./OPT.)	STANDARD ENGINE/ TRANS.	OPTIONAL ENGINE/ TRANS.	GVWR (LB)	GAWR (LB) FRONT/ REAR	BASE PAYLOAD (LB)	MAXIMUM TRAILER WT./ TONGUE LOAD (LB) PROPERLY EQUIPPED	MAXIMUM TRAILER WT./ KINGPIN LOAD (LB) PROPERLY EQUIPPED
FOUR-WHEEL-DRIVE MODELS (CONT.)									
K2500 REGULAR-CAB									
FLEETSIDE LONG-BOX HD	CK20903/E63/ C6P YHK or YGK	3/2	5700 V8/M5	5700 V8/A4 6.5L V8/A4/M5	8600	4250/6000	3960	7500/900 8000/950	7500/2500 8000/2000
K2500 EXTENDED-CAB									
FLEETSIDE LONG-BOX HD	CK20953/E63/ C6P YHK or YHH	6/5/3	5700 V8/M5	5700 V8/A4 6.5L V8/M5/A4	8600	4250/6000	3242	7500/900 8000/950	7500/2500 8000/2000
K3500 REGULAR-CAB									
FLEETSIDE LONG-BOX	CK30903/E63 YHK or YHH	3/2	5700 V8/M5	5700 V8/A4 7400 V8/M5/A4 6.5L V8/M5/A4	9200	4250/6084	4019	7500/900 10000/1000 8000/950	7500/3000 12500/3000 8000/3000
FLEETSIDE LONG-BOX DUAL-REAR- WHEELS	CK30903/E63/ R05	3/2	5700 V8/M5	5700 V8/A4 7400 V8/M5/A4 6.5L V8/M5/A4	10000	4250/7500	N/A	7500/900 10000/1000 8000/950	7500/3000 12500/3000 8000/3000
K3500 EXTENDED-CAB									
FLEETSIDE LONG-BOX DUAL-REAR- WHEELS	CK30953/E63/ R05	6/5/3	5700 V8/M5	5700 V8/A4 7400 V8/M5/A4 6.5L V8/M5/A4	10000	4250/7500	4222	7500/900 10000/1000 8000/950	7500/3000 12500/3000 8000/3000
K3500 CREW-CAB									
SINGLE REAR WHEELS	CK30943/E63	6/5	5700 V8/M5	5700 V8/A4 7400 V8/M5/A4 6.5L V8/M5/A4	9200	4500/6084	3373	8500/1000 10000/1000 8000/950	8500/3000 12500/3000 8000/3000
DUAL-REAR- WHEELS	CK30943/E63/ R05	6/5	5700 V8/M5	5700 V8/A4 7400 V8/M5/A4 6.5L V8/M5/A4	10000	4500/7500	N/A	8500/1000 10000/1000 8000/950	8500/3000 12500/3000 8000/3000

1. A-W: Advice. Please refer to Weights in back of Tech Guide for optional payloads.



C/K PICKUP

POWERTRAINS

Chevrolet offers a variety of engines, transmissions and rear axle ratios for the C/K Pickups. The following charts detail basic engine, transmission and axle specifications. See your 1996 Chevrolet Truck Order Guide for specific details.

ENGINES						
ENGINE	VORTEC 4300 V6	VORTEC 5000 V8	VORTEC 5700 V8	VORTEC 7400 V8 HD	6.5L V8 TURBO DIESEL	6.5L V8 TURBO DIESEL HD
Order Code Restrictions	L35 8500 GVW or Under	L30 Up To 7200 GVW	L31 All Applications	L29 Above 8500 GVW	L56 8500 GVW or Under	L65 Above 8500 GVW
SAE Net Horsepower @ RPM	200 @ 4400	230 @ 4600	255 @ 4600	290 @ 4000	180 @ 3400	190 @ 3400
SAE Net Torque lb-ft @ RPM	255 @ 2800	285 @ 2800	330 @ 2800	410 @ 3200	360 @ 1800	385 @ 1800
Fuel System	SFI	SFI	SFI	SFI	Indirect Fuel Injection	Indirect Fuel Injection
Clutch Size (in.)	11	12	12	12	12	12
Standard Battery Cold Cranking Amps @ 0°F	600	600	600	600	2 @ 600 each	2 @ 600 each
Standard Alternator Maximum Capacity (Amps)	100	100	100	124	100	100

	MANUAL			AUTOMATIC	
	MANUAL 5-SPEED W/OVERDRIVE	MANUAL 5-SPEED W/OVERDRIVE	MANUAL 5-SPEED W/OVERDRIVE AND DEEP LOW HEAVY-DUTY	ELECTRONICALLY CONTROLLED AUTOMATIC 4-SPEED OVERDRIVE W/TORQUE CONVERTER CLUTCH (4L60-E)	ELECTRONICALLY CONTROLLED AUTOMATIC 4-SPEED OVERDRIVE W/TORQUE CONVERTER CLUTCH HEAVY-DUTY (4L80-E)
Transmission Order Code	MG5	M50	MW3	M30	MT1
Application	8500 GVW or Under (w/L35, L30)	8500 GVW or Under (w/L31 only)	Above 8500 GVW (w/L31, L65, L29)	8500 GVW or Under	Above 8500 GVW and Turbo Diesel
Synchronized Speeds	1/2/3/4/5	1/2/3/4/5	1/2/3/4/5	—	—
Gear Ratios					
First	4.02	3.49	5.61	3.06	2.48
Second	2.32	2.16	3.04	1.63	1.48
Third	1.40	1.40	1.67	1.00	1.00
Fourth	1.00	1.00	1.00	0.70	0.75
Fifth	0.73	0.73	0.75	—	—
Reverse	3.55	3.55	5.61	2.29	2.08
Power Take-Off	No	No	Yes	No	No

REAR AXLES											
Availability	(See Order Guide)			(See Order Guide)		(See Order Guide)		(See Order Guide)		(See Order Guide)	
Make	American Axle			American Axle		American Axle		American Axle		American Axle	
Capacity (lb)	3750 Semi-Floating			4800 Semi-Floating		6000 Semi-Floating		6000 Full-Floating		6084-7500 Full-Floating	
Pinion and Ring Gear Type	Hypoid			Hypoid		Hypoid		Hypoid		Hypoid	
Axle Ratio Code	GU4	GU6	GT4	GU6	GT4	GT4	GT5	GT4	GT5	GT5	HC4
Ratio	3.08	3.42	3.73	3.42	3.73	3.73	4.10	3.73	4.10	4.10	4.56
Pinion Teeth	13	12	11	12	11	11	10	11	10	10	9
Ring Gear Teeth	41	41	41	41	41	41	41	41	41	41	41
Ring Gear Diameter (in.)	8.6	8.6	8.6	9.5	9.5	9.5	9.5	10.5	10.5	10.5	10.5

Note: Axle ratio availability depends on model, powertrain and emissions selected.



C/K PICKUP

FRONT AXLES							
Availability	K1500 & K2500 w/7200 GVWR		K2500 w/C6P & K3500			K30943	
Make/Capacity (lb)	American Axle/3925		American Axle/4250			American Axle/4500	
Pinion and Ring Gear Type	Hypoid		Hypoid			Hypoid	
Ratio	3.42	3.73	3.73	4.10	4.56	4.10	4.56
Pinion Teeth	12	11	11	10	9	10	9
Ring Gear Teeth	41	41	41	41	41	41	41
Ring Gear Diameter (in.)	8.25	8.25	9.25	9.25	9.25	9.25	9.25
Differential Type	2-Pinion Tapered Roller		2-Pinion Tapered Roller			2-Pinion Tapered Roller	
Bearings, Type	2-Pinion Tapered Roller		2-Pinion Tapered Roller			2-Pinion Tapered Roller	
Lubricant Capacity (pints)	4.5		6			6	

Note: Axle ratio availability depends on model, powertrain and emissions selected.

TRIM LEVELS

Chevrolet offers C/K Pickups in two primary trim levels — “Cheyenne” and “Silverado.” The following chart details major standard features. See your 1996 Chevrolet Truck Order Guide for details.

KEY: ■ = STANDARD, — = NOT INCLUDED		CHEYENNE (STANDARD)	SILVERADO (YE9)
BRAKES	Power-assisted, front disc, rear drum; self-adjusting. Four-wheel anti-lock system. Includes brake/transmission interlock.	■	■
EXHAUST	Single. Aluminized stainless steel.	■	■
FRAME	All-welded ladder-type, channel design and boxed front-end section. Section modulus (cu in.): Reg.-Cabs — 2.66 on C/K 1500 and C/K 2500 (2WD); 3.27 on C/K 1500 and C/K 2500 (4WD); 5.26 on C/K 2500 /C6P and C/K3500 (2WD); 5.25 on C/K2500 w/C6P and C/K3500 (4WD). Ext.-Cabs — 3.37 on C/K1500 and C/K2500 (2WD); 4.06 on C/K 1500 and C/K2500 (4WD); 6.06 on C/K 2500 w/C6P and C/K3500. Crew-Cab — 7.49 on all models.	■	■
FUEL TANK	25.0 gallon (approx.) capacity on C/K 10703/53 and C/K 20753 models. 34.0 gallon (approx.) capacity on all other models.	■	■
REAR AXLE	Hypoid semi-floating on C/K 1500 and 2500. Full-floating on C/K 2500/C6P w/L65 and C/K3500.	■	■
SHOCK ABSORBERS	25mm: C/K 1500 front and rear; 32mm: Front and rear on C/K2500 at 7200 lb GVWR and C/K3500; Rear on C/K2500 and 3500; 35mm: Front on C/K2500 at 8600 lb GVWR C/K 3500 and Crew-Cab.	■	■
STABILIZER BAR	4x2: Front 1.25 inch; 4x4: Front 1.18 inch.	■	■
STEERING	Integral power.	■	■
SUSPENSION, FRONT	4x2: Independent with computer-selected coil springs. 4x4: Independent with computer-selected torsion springs.	■	■
SUSPENSION, REAR	C/K1500 and 2500: Semi-elliptic two-stage multileaf springs. C/K3500: Semi-elliptic two-stage multileaf springs main/auxiliary.	■	■
TOW HOOKS	Two front on 4x4s.	■	■

EXTERIOR EQUIPMENT			
AIR DAM	Dark argent (not included on models at or above 8600 lb GVW).	■	■
BUMPER, FRONT	Bright appearance. Bright appearance (includes black rub strip with bright trim).	■	—
BUMPER, REAR	Bright appearance with black rub strip and step pad.	—	■
GLASS	Solar-Ray® tinted glass.	■	■
GRILLE	Molded plastic painted argent with argent air intake areas. Deluxe front appearance package with bright grille and bright trim with medium argent intake areas.	■	—
HEADLAMPS	Single rectangular halogen. Dual composite halogen.	■	—
HORN	Single electric note. Dual low- and high-note.	■	—



C/K PICKUP

EXTERIOR EQUIPMENT (CONT.)		CHEYENNE (STANDARD)	SILVERADO (YE9)
KEY: ■ = STANDARD, — = NOT INCLUDED			
INSULATION	Hood and cab-to-fender.	—	■
LAMPS	Center high-mounted stop lamp/cargo lamp. Underhood, reel-type, fixed.	■ —	■ ■
MIRRORS	RH and LH below-eyeline type, painted black. Head size is 8.5" x 5.0". RH and LH electric below-eyeline, outside rearview type, painted black. Head size is 8.5" x 5.0"	■ —	— ■
MOLDINGS	Black bodyside with bright trim and bright wheel opening (E63 only). (N/A K2500 C6P, K3500, Sportside and R05 models). Crew-Cab: Bright trim with wheel opening molding (R04).	— ■	■ ■
RUNNING LAMPS	Daytime.	■	■
SPARE TIRE AND WHEEL	Full-size.	■	■
SPARE TIRE CARRIER	Winch-type carrier mounted under frame at rear.	■	■
STORAGE COMPARTMENT	Additional underhood storage compartment. (Except when turbo diesel engine with TP2 auxiliary battery is ordered.)	■	■
TAILGATE	Removable.	■	■
TIRES	Steel Belted Radials. C/K1500 Reg.-Cab (2WD) P235/75R15. Ext.-Cab (2WD) P235/75R15. Reg.-Cab (4WD) P245/75R16. Ext.-Cab (4WD) P245/75R16. C/K2500 Reg.-Cab (2WD/4WD) and Ext.-Cab (2WD) LT225/75R16D. All models with C6P LT245/75R16E. C/K3500 Reg.-Cab, Ext.-Cab and Crew-Cab w/R04 LT245/75R16E. Reg.-Cab and Ext.-Cab (2WD) w/R05 LT225/75R16C/D. Reg.-Cab, Ext.-Cab (4WD) and Crew-Cab R05 LT225/75R16D.	■	■
WHEEL FLARES	4x4 at or above 8600 GVW.	■	■
WHEELS	Silver painted steel wheels with black hub ornament. (Argent painted on Crew-Cab) 15.0" x 7.0": C/K 1500 (2WD). 16.0" x 6.5": C/K 1500 (4WD), C/K 2500, C/K 3500 w/R04, C/K 3500 w/R05 (front only). 16.0" x 6.0": C/K 3500 w/R05 (rear only). Rally wheel trim. Crew-Cab: Rally trim.	■ — —	— ■ ■
WINDOWS	Swing-out rear quarter on Extended-Cab models only.	■	■
WIRING	Seven-lead wiring harness for trailering purposes.	■	■

INTERIOR EQUIPMENT		CHEYENNE (STANDARD)	SILVERADO (YE9)
AIR BAG	Driver's side (not included on models at or above 8600 lb GVWR).	■	■
AIR CONDITIONING	Front.	—	■
ARMRESTS	RH and LH padded, integral with door panels.	■	■
ASSIST HANDLES	Passenger side.	■	■
CAB BACK PANELS	Color-keyed carpet.	—	■
CIGARETTE LIGHTER	Located on instrument panel. Includes ashtray light and 2 auxiliary covered power outlets.	■	■
CUPHOLDERS	Two located in the dash.	■	■
DOMELAMP	Switch in LH and RH door jamb (two dome lamps with front door actuated switches on Crew-Cab). Dome lamp includes illuminated entry feature. Switches in all four doors on Crew-Cab models.	■ —	■ ■
DOOR TRIM	Vinyl color-keyed door trim panels with padded insert armrest, map pockets, large easily accessible door handles, and door reflectors. Color-keyed soft vinyl with cloth insert, map pockets with carpet trim, large easily accessible door handles and door reflectors with lights. NOTE: Scotchgard™ Fabric Protector on all cloth panel and trim.	■ —	— ■
DOORS	Side-door guard beams.	■	■
DRIVER'S CONVENIENCE GROUP	Speed Control, Tilt Steering, Power Windows and Power Door Locks.	—	■

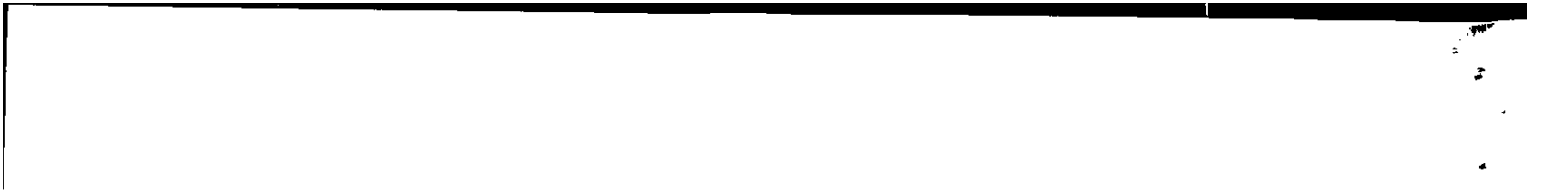

10



C/K PICKUP

INTERIOR EQUIPMENT (CONT.)		CHEYENNE (STANDARD)	SILVERADO (YE9)
KEY: ■ = STANDARD, — = NOT INCLUDED			
FLOOR COVERING	Embossed color-keyed rubber mat on Regular- and Extended-Cab models. Rubber mat is black in Crew-Cab models. Color-keyed carpeting and removable color-keyed rubber floor mats. NOTE: Scotchgard™ Fabric Protector on all cloth floor coverings.	■ —	— ■
GAGES	Including fuel level, odometer, oil pressure, trip odometer, speedometer, telltale lights, engine temperature, voltmeter and tachometer.	■	■
GLOVE BOX	Latched door with light.	■	■
HEADLAMP WARNING TONE	Headlamps on.	■	■
HEADLINER	Full-length color-keyed cloth with matching retainer moldings. Crew-Cab: Full-length color-keyed cloth with matching retainer moldings and three assist handles (RF, LR, RR).	■ ■	■ ■
HEATER	Includes front heater with windshield and side window defoggers.	■	■
HEATER DUCT	Rear seat area. Located on floor under front seats. (Crew-Cab models only.)	■	■
INSULATION	Provided on dash panels, cowl tops and sides, and doors. Extended-Cabs have additional insulation on the rear quarter and back panels and on floor coverings. Extra insulation is provided with diesel engines. Also includes insulation on headliners. Also includes insulation on Regular-Cab back panels.	■ — —	■ ■ ■
LIGHTING	Includes dome, reading, ashtray, glove box and cargo lamps with illuminated entry feature.	■	■
MIRROR	10-inch rearview.	■	■
RADIOS	ETR AM/FM stereo radio with Seek-Scan and digital clock. Includes two 6" diameter front-door-mounted speakers and two 4" x 6" rear-mounted speakers located above the door (4 speakers in all). ETR AM/FM stereo radio with Seek-Scan, digital clock, and cassette deck. Includes two 6" diameter front-door-mounted speakers and two 4" x 6" rear-mounted speakers located above the door (4 speakers in all).	■ —	— ■
SEATS	Regular-Cab: Front 3-passenger bench with head restraints and folding backrest. Front 3-passenger bench with head restraints and folding center armrest. Power lumbar and front seat-back storage pockets included. Front center armrest provides lift-up storage space that features a coin holder, a map net on the inside lid and a writing board. Extended-Cab: Front reclining 3-passenger 60/40 split bench with head restraints and folding rear bench seat. Front reclining 3-passenger 60/40 split bench with head restraints and folding rear bench seat includes center armrest. Power lumbar with front seats only and front seat-back storage nets included. Front center armrest provides lift-up storage space that features a coin holder, a map net on the inside lid and a writing board. Crew-Cab: Front 3-passenger bench with head restraints and folding backrest and rear 3-passenger bench with adjustable backrest. Front reclining 3-passenger 60/40 split bench with head restraints and folding rear bench seat includes center armrest. Power lumbar with front seats only and front seat back storage nets included. Front center armrest provides lift-up storage space that features a coin holder, a map net on the inside lid and a writing board. NOTE: Scotchgard™ Protector on all cloth seats and cloth door trim panels.	■ — ■ — ■ —	— ■ — ■ — ■
STEERING WHEEL	Simulated leather. Leather.	■ —	— ■
STORAGE TRAY	Full width behind seat on floor. (Regular-Cab models only).	—	■
SUNSHADE	Color-keyed cloth RH and LH, padded with storage strap on LH unit and visor mirror on RH unit. Crew Cab: Padded, color-keyed cloth RH and LH sunshades with extenders and illuminated mirrors. LH sunshade has storage strap.	■ —	■ ■
TOOLS	Mechanical jack and wheel wrench located behind front seat or on rear compartment floor.	■	■
WINDSHIELD WIPERS	Intermittent.	■	■



C/K PICKUP

PREFERRED EQUIPMENT GROUPS

Preferred Equipment Groups (PEGs) are convenient option packages that can save your customers money. They would pay appreciably more by buying all the options in a Preferred Equipment Group as individual options. (Savings based on a comparison of Manufacturer's Suggested Retail Price of option packages vs. MSRP of individual options purchased separately.) See your 1996 Chevrolet Truck Order Guide and Vehicle Price Schedule for specific information.

OPTIONS

These options can be ordered individually in addition to the Preferred Equipment Groups if not already included. See your 1996 Chevrolet Truck Order Guide for availability and restrictions. The Option Code is listed in **bold type**.

Air Cleaner, High Capacity (N/A with diesel engine)	K47
Air Conditioning	C60
Appearance Package: Chrome Grille, Composite Headlamps and Dual Horns	V22
Axles, Rear:	
3.08	GU4
3.42	GU6
3.73	GT4
4.10	GT5
4.56	HC4
Axle, Rear Locking Differential	G80
Battery, Heavy-Duty, Auxiliary	TP2
Bedliner	BZY
Bumper Delete Provisions	EF1
Bumper, Painted Rear Step (N/A with YE9 Silverado)	V43
Bumper, Chromed Rear Step w/ Rub Strip	VB3
Bumper, Chromed Front Deluxe w/Rub Strip	VG3
Chassis Equipment, Heavy-Duty	F44
Cold Climate Package (includes Engine Block Heater)	V10
Convenience Package, Driver's (includes Tilt-Wheel™ Steering and Electronic Speed Control)	ZQ3
Cooling System:	
Engine Oil Cooler	KC4
Heavy Duty Transmission	KNP
Defogger, Rear Window (Extended- and Crew-Cab models only)	C49
Easy Access System, Rear Seat located on passenger side on C/K10753 Models. Requires YE9 Silverado)	E24
Emissions	
Federal	FE9
California	YF5
Massachusetts/New York	NG1
Federal Emissions Override	NC7
Cal./Mass./N.Y. Emissions Override	NB8
Engines:	
Vortec 4300 V6 SFI	L35
Vortec 5000 V8 SFI	L30
Vortec 5700 V8 SFI	L31
Vortec 7400 V8 SFI	L29
6.5L V8 Turbo Diesel	L56
6.5L V8 Turbo Diesel	L65
Alternative Fuel (LPG and CNG conversion-ready) ..	KL5
Floor Covering	
Full Floor Rubber, Color-Keyed (requires YE9 Silverado)(N/A on Crew-Cab models)	BG9

Carpet (N/A with X81 Work Truck, YE9 Silverado or Crew-Cab models)	B30
Front Floor Mats (N/A on Crew-Cab models)	B32
Rear Floor Mats (Extended-Cab models only)	B33
Glass, Solar-Ray® Deep-Tinted, side and rear windows (Extended- and Crew-Cab only)	AJ1
GVWR	
6100 lb	C5M
6200 lb	Q4B
6600 lb	C5S
6800 lb	C5U
7200 lb	C5Z
8600 lb	C6P
9000 lb	C6U
9200 lb	C6W
10,000 lb	C7A
Keyless Entry, Remote	AU0
Lamps, Roof Marker (included w/Dual Rear Wheels R05) (N/A with 1500 series models)	U01
License Plate Bracket, Front	VK3
Locks, Power Door	AU3
Marketing Packages (See Order Guide for details):	
Convenience Package	R9A
Bright Appearance Package	R9B
Commercial Option Package	R9C
Sport Package (C/K 10703 w/ E62 only)	BYP
Mirrors:	
Electrochromic (includes light-sensitive rearview mirror and eight-point compass. Requires YE9 Silverado)	DD7
Exterior Camper Type (LH and RH stainless steel. Mirror head: 7.5" x 10.5")	DF2
Moldings, Bodyside Black with Bright Trim	B85
Off-Road Chassis Package (K1500 only) (includes skid plate NZZ) (Requires YE9 Silverado)	Z71
Paint, Exterior	
Solid	ZY1
Conventional Two-Tone (Requires YE9 Silverado Decor)	ZY2
Deluxe Two-Tone (Requires YE9 Silverado Decor)	ZY4
Radio Equipment:	
Radio Delete	UL5
ETR AM/FM Stereo Radio w/Seek-Scan, Stereo Cassette, Digital Clock	UM6
ETR AM/FM Stereo Radio with Seek- Scan with Automatic Tone Control, Stereo Cassette Deck, Digital Clock, TheftLock™ and Speed-Compensated Volume (with YE9 Silverado includes an enhanced performance speaker system)	UL0

ETR AM/FM Stereo Radio with Seek- Scan with Automatic Tone Control, Compact Disc Player, Digital Clock, Theft Lock™ and Speed-Compensated Volume (with YE9 Silverado includes an enhanced speaker system)	UN0
ETR AM/FM Stereo Radio with Seek- Scan with Automatic Tone Control, Compact Disc Player, Cassette Deck, Digital Clock, TheftLock™ and Speed- Compensated Volume (with YE9 Silverado Decor includes an enhanced performance speaker system)	UP0
Recreational Sales Package (For information purposes only. YF7 is available for ordering through authorized CQACP manufacturers only)	YF7
Seat Type:	
Bench Seat	A52
60/40 Reclining Split Bench Seat	AE7
Reclining High-Back Bucket Seat	A95
Seat, Power Driver's (Crew-Cab and Ext.-Cab models with YE9 Silverado only)	AG9
Seat, Rear 3-Passenger Bench not desired (Extended-Cab Only) ..	YG4
Shock Absorbers, Front and Rear, Heavy-Duty	F51
Gas 46mm Bilstein	FG5
Skid Plate (4x4 only)	NZZ
Snow Plow Prep Package (Reg. Cab 4x4 only)	VYU
Springs, Front Heavy-Duty (4x4 only) ..	F60
Tow Hooks, Front (4x2 only)	V76
Trailerling Special Equipment (includes weight distributing hitch platform)	ZB2
Transfer Case, Electronic Shift Control (1500 and 2500 Series only)	NP1
Transmissions:	
5-Speed Manual w/Overdrive	MG5
5-Speed Manual w/Overdrive	M50
5-Speed Manual w/Deep Low and Overdrive, HD	MW3
4-Speed Electronically Controlled Automatic w/Overdrive	M30
4-Speed Electronically Controlled Automatic w/Overdrive, HD	MT1
Wheels:	
Rally Trim	P06
Cast Aluminum (15" x 7") (C1500) ..	N90
Cast Aluminum (16" x 7") (K1500) ..	PF4
Chrome Wheels (15" x 7") (C1500) ..	N83
Dual Rear (C/K3500 only)	R05
Windows, Sliding Rear	A28
Work Truck (See Order Guide for details)	X81



C/K PICKUP

TIRES

KEY: ALS = ALL-SEASON SBR = STEEL-BELTED RADIAL PLY BW = BLACKWALL ALT = ALL TERRAIN WL = WHITE LETTERED
 HWY = HIGHWAY OOR = ON-OFF ROAD WOL = WHITE OUTLINE LETTERED

TIRE DESCRIPTION		FRONT	REAR	SPARE
P235/75R15	ALS/SBR/BW	XFL	YFL	ZFL
P235/75R15	ALS/SBR/WL	XFN	YFN	ZFN
P245/75R16	ALT/SBR/BW	XGA	YGA	ZGA
P245/75R16	ALT/SBR/WOL	XGB	YGB	ZGB
P265/75R16	ALT/SBR/BW	XGC	YGC	ZGC
P265/75R16	ALT/SBR/WOL	XGD	YGD	ZGD
LT215/85R16D	HWY/SBR/BW	XYK	YYK	ZYK
LT215/85R16D	OOR/SBR/BW	XYL	YYL	ZYL
LT225/75R16C	ALS/SBR/BW	XHE	YHE	ZHE
LT225/75R16D	ALS/SBR/BW	XHP	YHP	ZHP
LT225/75R16D	OOR/SBR/BW	XHR	YHR	ZHR
LT245/75R16C	OOR/SBR/BW	XBN	YBN	ZBN
LT245/75R16C	OOR/SBR/WOL	XBX	YBX	ZBX
LT245/75R16E	ALS/SBR/BW	XHH	YHH	ZHH
LT245/75R16E	OOR/SBR/BW	XGK	YGK	ZGK

DIMENSIONS

MODEL	C/K 1500 PICKUP REG.-CAB/EXT.-CAB SPORTSIDE/FLEETSIDE			C/K 2500 PICKUP REG.-CAB/EXT.-CAB FLEETSIDE		C/K3500 PICKUP REG.-CAB/EXT.- CAB FLEETSIDE		C/K 3500 PICKUP CREW-CAB	
	C/K 10703 C/K 10753	C/K 10903 C/K 10953		CC 20753 CC 20903	C/K 20903 C/K 20953	C/K 30903 C/K 30953		C/K 30943	
BODY CODE/ OPTION CODE	E62	E63	E63	C5Z	C6P	C6U & C6W	C7A (OPT.)	R04	R05

EXTERIOR DIMENSIONS

EXTERIOR DIMENSIONS									
BODY									
Wheelbase (in.)									
Reg.-Cab		117.5	131.5	—	131.5	131.5	131.5	168.5	
Ext.-Cab L101		141.5	155.5	141.5	155.5	155.5	155.5	—	
Overall Length (in.) w/o Rear Bumper									
Reg.-Cab		194.5	213.4	—	213.4	213.4	213.4	250.9	
Ext.-Cab L103		217.5	236.6	217.5	236.6	236.6	236.6	—	
Overall Height (in.)									
Reg.-Cab-2WD		70.4	—	—	75.5	75.5	75.5	71.7	68.3
Reg.-Cab-4WD		73.8	—	—	75.8	75.8	75.8	73.8	70.2
Ext.-Cab-2WD		70.4	73.0	73.0	75.5	75.5	75.5	—	—
Ext.-Cab-4WD H431		73.8	74.3	74.3	75.8	75.8	75.8	—	—
Maximum Width (in.) W103	77.1	76.8	76.3	76.8	76.8	76.8	94.3	76.8	94.3
Bumper to Axle (in.)									
Front L104		35.4	35.4	35.4	35.4	35.4	35.4	35.4	35.4
Rear Overhang (w/o bumper) L105		41.6	46.5	41.6	46.5	46.5	46.5	46.5	46.5
Cab to Rear Axle (in.) L404		41.9	55.9	41.9	55.9	55.9	55.9	55.9	55.9
Cab to End of Frame (in.)		78.7	97.6	78.7	97.6	97.6	97.6	97.6	97.6
Bumper to Back of Cab (in.)									
Reg.-Cab		111.0	—	—	111.0	111.0	111.0	148.5	—
Ext.-Cab L403		135.0	135.0	135.0	135.0	135.0	135.0	—	—

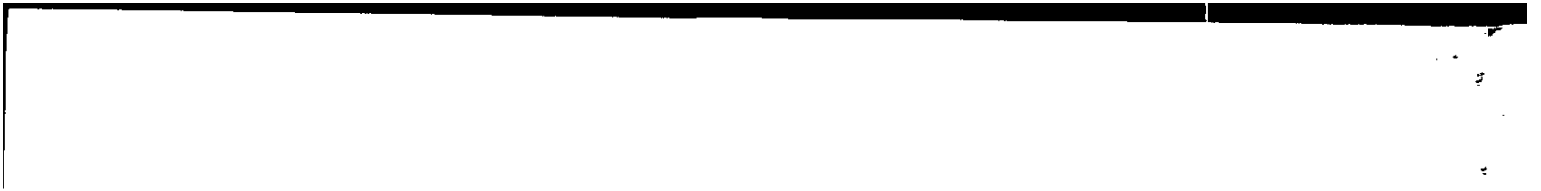

C/K PICKUP

DIMENSIONS (CONT.)

MODEL	C/K 1500 PICKUP REG.-CAB/EXT.-CAB SPORTSIDE/FLEETSIDE			C/K 2500 PICKUP REG.-CAB/EXT.-CAB FLEETSIDE		C/K 3500 PICKUP REG.-CAB/EXT.- CAB FLEETSIDE		C/K 3500 PICKUP CREW-CAB		
	MODEL NUMBER		C/K 10703 C/K 10753	C/K 10903 C/K 10953	CC 20753 CC 20903	C/K 20903 C/K 20953	C/K 30903 C/K 30953		C/K 30943	
BODY CODE/ OPTION CODE	E62	E63	E63	C5Z	C6P	C6U & C6W	C7A (OPT.)	R04	R05	
EXTERIOR DIMENSIONS										
Ground to Top of Rear Load Floor (in.) 2WD 4WD H502	29.0 32.4			31.6 32.9	34.0 34.4	34.0 34.4		33.7 33.9	33.7 33.9	
Ground Clearance (in.) Front/Rear Reg.-Cab-2WD Reg.-Cab-4WD Ext.-Cab-2WD Ext.-Cab-4WD	6.8/6.6 8.7/8.0 6.9/6.9 9.0/8.4			— — 7.7/7.2 —	8.4/6.4 6.3/6.4 8.0/6.4 9.0/7.8	8.4/6.4 6.3/6.4 8.0/6.4 6.3/6.4		7.5/6.4 7.3/6.4 — —		
Turning Diameter Curb-to-Curb (ft) Reg.-Cab-2WD/4WD Ext.-Cab-2WD/4WD	39.8/42.9 46.6/50.9		43.7/47.8 50.6/55.4	—/— 46.6/50.9	43.7/47.8 —/—	43.4/44.7 50.6/51.6	43.4/44.7 50.2/51.6	43.4/44.7 50.2/51.6	53.8/55.4 —/—	53.8/55.4 —/—
CARGO BOX Inside Length at Floor (in.) L505	78.7		97.6	78.7	97.6	97.6		97.6		
Inside Width at Top Rear (in.) W204	50.9	61.9	61.9	61.9	61.9	61.9		61.9		
Inside Width at Floor (in.) W203	53.3	64.4	64.4	64.4	64.4	64.4		64.4		
Inside Width between Wheelhousings (in.) W201	49.1			49.1	49.1	49.1		49.1		
Inside Height (in.) W503	19.2			19.2	19.2	19.2		19.2		
Tailgate Width (in.) (Top)	50.9	62.0	62.0	62.0	62.0	62.0		62.0		
Cargo Volume (cu ft)	42.1	55.6	69.1	55.6	69.1	69.1		69.1		
SIGN PANEL AREA (in.) Reg.-Cab Ext.-Cab Crew-Cab	17 x 48 3/4 17 x 77 1/2 —			17 x 48 3/4 17 x 77 1/2 —	17 x 48 3/4 17 x 77 1/2 —	17 x 48 3/4 17 x 77 1/2 —		— — 17 x 85		

INTERIOR DIMENSIONS

CAB									
Headroom (in.) Front/Rear ¹	H63	39.9/37.5			39.9/37.5	39.9/37.5	39.9/37.5		39.9/40.8
Legroom (in.) Front/Rear ¹	L51	41.7/34.8			41.7/34.8	41.7/34.8	41.7/34.8		41.7/37.9
Shoulder Room (in.) Front/Rear ¹	S1/V4	65.4/67.6			65.4/67.6	65.4/67.6	65.4/67.6		65.4/64.9
Hip Room (in.) Front/Rear ¹	H5/W6	60.0/64.2			60.0/64.2	60.0/64.2	60.0/64.2		60.0/59.3
Extended-Cab Cargo Volume (cu ft) w/o Rear Seat	40.5			40.5	40.5	40.5		—	

¹ Rear dimensions apply to Extended-Cab and Crew-Cab models.



2



C/K CHASSIS-CAB INTRODUCTION

C/K CHASSIS-CAB

The C/K 3500 Chassis-Cab is available in two trim levels: the "Cheyenne" (standard) and the "Silverado" (uplevel).

Changes on the C/K Chassis-Cab for 1996 include:

- New Front Bench Seat Armrest Stowage Compartment with bench seats on uplevel trim YE9 Silverado. Includes a coin holder, a map net and a writing board
 - Vortec 5700 V8 engine (L31). Replaces 5.7L (L05) and includes sequential fuel injection, higher horsepower and torque ratings and spark plugs with 100,000-mile expected life
 - Vortec 7400 V8 Engine (L29). Replaces 7.4L (L19) and includes sequential fuel injection, higher horsepower and torque ratings and spark plugs with 100,000-mile expected life
 - Standard On Board Diagnostics (OBD II)
 - 4-speed 4L80-E Automatic Transmission Enhancements (MT1)
 - 40 gallon fuel capacity on C/K 31003, 31403 and C31803 models with new standard Dual Fuel Tank design. 40 gallon capacity combines existing 22 gallon side fuel tank with new 18 gallon rear fuel tank. If desired, optional Rear Fuel Tank Delete (NQZ) is also available
 - Two Auxiliary Power Outlets with spring-loaded doors
 - Standard Daytime Running Lamps
 - Standard Illuminated Entry
 - Standard DEX-COOL™ Extended-Life Engine Coolant. Coolant color is fluorescent orange and the change interval is now 5 years/100,000 miles
 - Rear Seat Heat Ducts on Crew-Cab models
 - One new Interior Color
 - One new Exterior Color (available on all models except C31003, 31403 and 31803 at 15,000 lb GVW)
 - New Underhood Storage Compartment
-

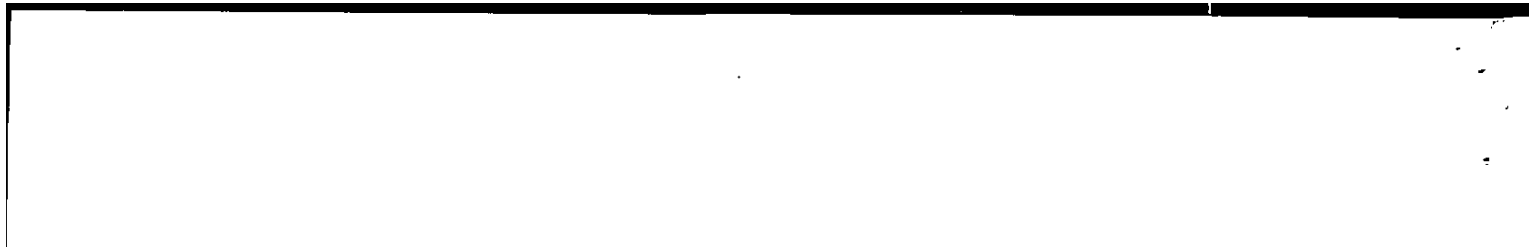

C/K CHASSIS-CAB

MODEL SELECTION SUMMARY

Use the chart below to choose the model that fits your customer's needs. Please note that the Base Payloads shown reflect the maximum allowable weight of cargo that can be carried in a standard model, including occupants. (They are calculated by subtracting curb weight from the GVWR.) To calculate payloads for models with optional equipment, please refer to the WEIGHTS section in the back of this book or consult your 1996 GM PROSPEC. Also, the Maximum Trailer Weights shown below are based on vehicles that are properly equipped. See your Chevrolet Truck Order Guide for specific details.

SERIES	MODEL NUMBER/ BODY CODE/ OPTION CODE	PASSENGER CAPACITY (STD./OPT.)	STANDARD ENGINE/ TRANS.	OPTIONAL ENGINE/ TRANS.	GVWR (LB)	GAWR (LB) FRONT/ REAR	BASE PAYLOAD (LB)	MAXIMUM TRAILER WT./ TONGUE LOAD (LB) PROPERLY EQUIPPED	MAXIMUM TRAILER WT./ KINGPIN LOAD (LB) PROPERLY EQUIPPED
TWO-WHEEL-DRIVE MODELS									
C2500 REGULAR-CAB									
SINGLE REAR WHEELS	CC20903/ ZW9	3/2	5700 V8/M5	5700 V8/A4 6.5L V8/M5/A4	8600	3600/6000	4711	8000/950 8500/1000	8000/3000 8500/2500
C3500 REGULAR-CAB									
SINGLE REAR WHEELS	CC30903/ ZW9/ YGK or YHH	3/2	5700 V8/M5	5700 V8/A4 7400 V8/M5/A4 6.5L V8/M5/A4	9000	3600/6084	N/A	8000/950 10000/1000 8500/1000	8000/3000 11000/3000 8500/3000
DUAL REAR WHEELS	CC30903/ ZW9/R05	3/2	5700 V8/M5	5700 V8/A4 7400 V8/M5/A4 6.5L V8/M5/A4	10000	3600/7500	N/A	9500/1000 10000/1000 8500/1000	9500/3000 13000/3000 8500/3000
DUAL REAR WHEELS "STRAIGHT FRAME"	CC31003/ ZW9	3/2	5700 V8/M5	5700 V8/A4 7400 V8/M5/A4 6.5L V8/M5/A4	10000	3880/7500	5048	9500/1000 10000/1000 8500/1000	9500/3000 13000/3000 8500/3000
DUAL REAR WHEELS "STRAIGHT FRAME"	CC31003/ ZW9	3/2	5700 V8/M5	5700 V8/A4 7400 V8/M5/A4 6.5L V8/M5/A4	11000	4100/8250	N/A	9500/1000 10000/1000 8500/1000	9500/3000 13000/3000 8500/3000
DUAL REAR WHEELS "STRAIGHT FRAME" LONG WHEELBASE	CC31403/ ZW9	3/2	5700 V8/M5	5700 V8/A4 7400 V8/M5/A4 6.5L V8/M5/A4	10000	3800/7500	4864	9500/1000 10000/1000 8500/1000	9500/3000 13000/3000 8500/3000
DUAL REAR WHEELS "STRAIGHT FRAME" LONG WHEELBASE	CC31403/ ZW9	3/2	5700 V8/M5	5700 V8/A4 7400 V8/M5/A4 6.5L V8/M5/A4	11000	4100/8250	N/A	9500/1000 10000/1000 8500/1000	9500/3000 13000/3000 8500/3000
C3500 HD REGULAR-CAB									
DUAL REAR WHEELS	CC31003/ ZW9/C5B	3/—	7400 V8/M5	7400 V8/A4 6.5L V8/M5/A4	15000	5000/11000	N/A	10000/1000 10000/1000	12500/4000 10500/4000
DUAL REAR WHEELS	CC31403/ ZW9/C5B	3/—	7400 V8/M5	7400 V8/A4 6.5L V8/M5/A4	15000	5000/11000	N/A	10000/1000 10000/1000	12500/4000 10500/4000
DUAL REAR WHEELS	CC31803/ ZW9	3/—	7400 V8/M5	7400 V8/A4 6.5L V8/M5/A4	15000	5000/11000	8742	10000/1000 10000/1000	12500/4000 10500/4000
C3500 CREW-CAB									
SINGLE REAR WHEELS	CC30943/ ZW9	6/5	5700 V8/M5	5700 V8/A4 7400 V8/M5/A4 6.5L V8/M5/A4	9000	4100/6084	3900	7500/900 10000/1000 8000/950	7500/3000 10500/3000 8000/3000
DUAL REAR WHEELS	CC30943/ ZW9/R05	6/5	5700 V8/M5	5700 V8/A4 7400 V8/M5/A4 6.5L V8/M5/A4	10000	4100/7500	N/A	9000/1000 10000/1000 8000/950	9000/3000 12500/3000 8000/3000

N/A—Will Advise. Please refer to Weights in back of Tech Guide for optional payloads.



2
3
4



C/K CHASSIS-CAB

SERIES	MODEL NUMBER/ BODY CODE/ OPTION CODE	PASSENGER CAPACITY (STD./OPT.)	STANDARD ENGINE/ TRANS.	OPTIONAL ENGINE/ TRANS.	GVWR (LB)	GAWR (LB) FRONT/ REAR	BASE PAYLOAD (LB)	MAXIMUM TRAILER WT./ TONGUE LOAD (LB) PROPERLY EQUIPPED	MAXIMUM TRAILER WT./ KINGPIN LOAD (LB) PROPERLY EQUIPPED
FOUR-WHEEL-DRIVE MODELS									
K2500 REGULAR-CAB									
SINGLE REAR WHEELS	CK20903/ ZW9	3/2	5700 V8/M5	5700 V8/A4 6.5L V8/M5/A4	8600	4250/6000	4340	7500/900 8000/950	7500/ 2500 8000/ 2000
K3500 REGULAR-CAB									
SINGLE REAR WHEELS	CK30903/ ZW9/ YGK or YHH	3/2	5700 V8/M5	5700 V8/A4 7400 V8/M5/A4 6.5L V8/M5/A4	9200	4250/6084	4399	7500/900 10000/1000 8000/950	7500/ 3000 10500/ 3000 8000/ 3000
DUAL-REAR-WHEELS	CK30903/ ZW9/R05	3/2	5700 V8/M5	5700 V8/A4 7400 V8/M5/A4 6.5L V8/M5/A4	10000	4250/7500	4979	7500/900 10000/1000 8000/950	7500/ 3000 12500/ 3000 8000/ 3000
K3500 REGULAR-CAB									
DUAL-REAR-WHEELS "STRAIGHT FRAME"	CK31003/ ZW9	3/2	5700 V8/M5	5700 V8/A4 7400 V8/M5/A4 6.5L V8/M5/A4	12000	4500/8600	6741	7500/900 10000/1000 8000/950	7500/ 3000 12500/ 3000 8000/ 3000
DUAL-REAR-WHEELS "STRAIGHT FRAME" LONG WHEELBASE	CK31403/ ZW9	3/2	5700 V8/M5	5700 V8/A4 7400 V8/M5/A4 6.5L V8/M5/A4	12000	4500/8600	N/A	7500/900 10000/1000 8000/950	7500/ 3000 12500/ 3000 8000/ 3000
K3500 CREW-CAB									
SINGLE REAR WHEELS	CK30943/ ZW9	6/5	5700 V8/M5	5700 V8/A4 7400 V8/M5/A4 6.5L V8/M5/A4	9200	4500/6084	3753	7500/900 10000/1000 8000/950	7000/ 3000 10500/ 3000 8000/ 3000
DUAL-REAR-WHEELS	CK30943/ ZW9/R05	6/5	5700 V8/M5	5700 V8/A4 7400 V8/M5/A4 6.5L V8/M5/A4	10000	4500/7500	N/A	8500/1000 10000/1000 8000/950	8500/3000 12500/ 3000 8000/ 3000

N/A--Will Advise. Please refer to Weights in back of Technical Guide for optional payloads.

POWERTRAINS

Chevrolet offers a variety of engines, transmissions and rear axle ratios for the C/K Chassis-Cab. The following charts detail basic engine, transmission and axle specifications. See your 1996 Chevrolet Truck Order Guide for details.

	ENGINES		
	VORTEC 5700 V8 HD	VORTEC 7400 V8 HD	6.5L V8 TURBO DIESEL HD
Order Code	L31	L29	L65
Availability	At or Under 10,000 GVW	Above 10,000 GVW	All Models
SAE Net Horsepower @ rpm	255 @ 4600	250 @ 4200	190 @ 3400
SAE Net Torque lb-ft @ rpm	330 @ 2800	330 @ 2800	385 @ 1800
Fuel System	SFI	SFI	Indirect Fuel Injection
Clutch Size (in.)	12	12	12
Standard Battery Cold Cranking Amps @ 0°F	600	600	2 @ 600 each
Standard Alternator Maximum Capacity (Amps)	100	124	100



C/K CHASSIS-CAB

TRANSMISSIONS		
	MANUAL 5-SPEED W/OD HEAVY-DUTY (NV4500)	ELECTRONICALLY CONTROLLED AUTOMATIC 4-SPEED W/OD AND TORQUE CONVERTER CLUTCH, HD (HM4L80-E)
Order Code	MW3	MT1
Availability	All Models	All Models
Synchronized Speeds	1/2/3/4/5	—
Gear Ratios		
First	5.61	2.48
Second	3.04	1.48
Third	1.67	1.00
Fourth	1.00	0.75
Fifth	0.75	—
Reverse	5.61	2.08
Power Take-Off	Yes	No

REAR AXLES										
Make	American Axle									Dana
Capacity (lb)	6000 Semi-Floating		6084 Full-Floating		7500 Full-Floating		8600 Full-Floating			11,000 Full-Floating
Availability	C/K20903		C/K30903- 30943 W/R04		C/K30903- 30943 W/R05		C/K31003-31403			C3500 HD
Pinion & Ring Gear Type	Hypoid		Hypoid		Hypoid		Hypoid			Hypoid
Axle Ratio Code	GT4	GT5	GT5	GT5	HC4	GT4	GT5	HC4	GK9	HC7
Ratio	3.73	4.10	4.10	4.10	4.56	3.73	4.10	4.56	4.63	5.13
Pinion Teeth	11	10	10	10	9	11	10	9	8	7
Ring Gear Teeth	41	41	41	41	41	41	41	41	37	37
Ring Gear Diameter (in.)	9.5	9.5	10.5	10.5	10.5	10.5	10.5	10.5	11.5	11.5

Note: Axle Ratio depends on model, powertrain and emissions selected.

FRONT AXLE (K MODELS)						
Make	American Axle					
Capacity (lb)	4250			4500		
Availability	K20903-K30903			K31003-31403-30943		
Pinion and Ring Gear Type	Hypoid			Hypoid		
Ratio	3.73	4.10	4.56	3.73	4.10	4.56
Pinion Teeth	11	10	9	11	10	9
Ring Gear Teeth	41	41	41	41	41	41
Ring Gear Diameter (in.)	8.25	8.25	8.25	9.25	9.25	9.25
Differential Type Bearings, Type	2-Pinion Tapered Roller			2-Pinion Tapered Roller		
Lubricant Capacity (pints)	4.5			6		

Note: Axle Ratio depends on model, powertrain and emissions selected.

TRIM LEVELS

Chevrolet offers all Chassis-Cabs in two trim levels, "Cheyenne" and "Silverado." The following chart details major standard features. See your 1996 Chevrolet Truck Order Guide for more details.

CHASSIS EQUIPMENT			
KEY: ■ = STANDARD, — = NOT INCLUDED		CHEYENNE (STANDARD)	SILVERADO (YE9)
BRAKES	Power-assisted, front disc, rear drum; self-adjusting. Four-wheel anti-lock system. Includes Brake/Transmission Interlock.	■	■
EXHAUST	Single. Aluminized stainless steel.	■	■
FRAME	All-welded ladder-type, channel design and boxed front-end section. Section modulus (cu in.): C/K20903 - 30903: 2WD-5.26 cu in.; 4WD-5.25 cu in. C/K31003 - 31403: 2WD-6.47 cu in.; 4WD-6.76 cu in. 3500HD: 31003, 31403-8.42, 31803-9.75 cu in. Crew-Cab: 7.49 cu in.	■	■
FUEL TANK	34.0 gallon (approx.) capacity on C/K 20903, 30903 and Crew-Cab models. 40.0 gallon (approx.) capacity on C/K 31003, 31403 and 3500 HD. (Dual tank design, including 22 gallon side fuel tank and 18 gallon rear fuel tank.)	■	■
REAR AXLE	Full-floating on C/K 3500 models. Semi-floating on C/K 20903.	■	■



1
2
3



C/K CHASSIS-CAB

CHASSIS EQUIPMENT (CONT.)			
KEY: ■ = Standard, — = Not Included		CHEYENNE (STANDARD)	SILVERADO (YE9)
SHOCK ABSORBERS	Front: 35 mm; Rear: 32 mm (35 mm on C3500 HD).	■	■
STABILIZER BAR	4x2: Front 1.25 inch. 4x4: Front 1.18 inch.	■	■
STEERING	Integral Power.	■	■
SUSPENSION, FRONT	4x2: Independent with computer-selected coil springs (I-beam/leaf springs on C3500 HD). 4x4: Independent with computer-selected torsion bars.	■ ■	■ ■
SUSPENSION, REAR	Semi-elliptic two-stage multileaf springs on C/K 20903 models. Semi-elliptic two-stage multileaf springs main/auxiliary on C/K 3500 models. (No auxiliary on C3500 HD).	■	■
TOW HOOKS	Two front on 4x4s.	■	■
EXTERIOR EQUIPMENT			
FRONT BUMPER	Bright appearance. Bright appearance w/black rub strip and bright trim.	■ —	— ■
GLASS	Solar-Ray® tinted glass.	■	■
GRILLE	Molded plastic painted argent with argent air intake areas. <i>Deluxe front appearance package with bright grille and bright trim with argent air intake areas.</i>	■ —	— ■
HEADLAMPS	Single rectangular halogen. Composite halogen.	■ —	— ■
HORN	Single electric low-note. Dual low- and high-note (standard C3500 HD).	■ —	— ■
INSULATION	Hood and cab-to-fender.	—	■
LAMPS	Center high-mounted stop lamp/cargo lamp (N/A on 3500HD). Five amber roof marker lamps on dual rear wheel models only. Underhood, reel type, fixed.	■ —	■ ■
MIRRORS	RH and LH below-eye-line type, painted black. Head size 8.5" x 5.0." RH and LH electric below-eye-line type, painted black. Head size 8.5" x 5.0" (Models over 10,000 lb GVWR use 9.0" x 6.5" mirrors.)	■ —	— ■
RUNNING LAMPS	Daytime.	■	■
SPARE TIRE AND WHEEL	Full-size (20903 and 30903 models only).	■	■
SPARE TIRE CARRIER	Winch-type carrier mounted under frame at rear (20903 and 30903 models only).	■	■
STORAGE COMPARTMENT	Additional underhood storage compartment. (Except when turbo diesel engine or TP2 auxiliary battery is ordered.)	■	■
TIRES	Four on single-rear-wheel models and six on dual-rear-wheel models. C/K 20903, C/K 30903 and C/K 30943 w/R04: LT245/75R16E. C/K 3500 w/R05: LT225/75R16 C/D. 3500 HD: 225/70R 19.5F (See Order Guide for details).	■	■
WHEELS	Silver painted steel wheels with black hub ornament. C/K 20903, C/K 30903 and C/K 30943 w/R04: 16.0" x 6.5". C/K 3500 w/R05: 16.0" x 6.0". 3500 HD: 19.5" x 6.0". Rally wheel trim. Crew-Cab: Rally trim.	■ — —	— ■ ■
WHEEL OPENING FLARES	Front. (K2500 only)	■	■
WIRING	7-lead wiring harness for trailering purposes (20903 and 30903 models only).	■	■
INTERIOR EQUIPMENT			
AIR CONDITIONING	Front.	—	■
ARMRESTS	RH and LH padded integral with door panels.	■	■
ASSIST HANDLES	Passenger side.	■	■
CAB BACK PANELS	Color-keyed carpet.	—	■
CIGARETTE LIGHTER	Located on instrument panel. Includes ashtray light and two covered auxiliary power outlets.	■	■
CUPHOLDERS	Two located in dash.	■	■
DOME LAMP	Switch in LH and RH door jamb (two lamps with front door-actuated switches on Crew-Cab). Dome lamp includes illuminated entry feature. Crew-Cab includes switches in all doors.	■ —	■ ■



C/K CHASSIS-CAB

INTERIOR EQUIPMENT (CONT.)		CHEYENNE (STANDARD)	SILVERADO (YES)
KEY: ■ = Standard, — = Not Included			
DOOR TRIM	Vinyl color-keyed door trim panels with padded insert armrest, map pockets, large easily accessible door handles, and door reflectors. Color-keyed soft vinyl with cloth insert, map pockets with carpet trim, large easily accessible door handles, door reflectors with lights. NOTE: Scotchgard™ protection on all cloth panel and trim.	■ —	— ■
DOORS	Side-door guard beams.	■	■
DRIVER'S CONVENIENCE GROUP	Speed Control, Tilt Steering, Power Windows and Power Door Locks.	—	■
FLOOR COVERING	Embossed color-keyed rubber mat on Regular-Cab models. Rubber mat is black on Crew-Cab models. Color-keyed carpeting with removable color-keyed rubber floor mats. NOTE: Scotchgard™ Protector on all cloth floor coverings.	■ —	— ■
GAGES	Including fuel level, odometer, oil pressure, speedometer, telltale lights, engine temperature, voltmeter and tachometer.	■	■
GLOVE BOX	Latched door with light.	■	■
HEADLINER	Cloth with matching retainer moldings, color-keyed.	■	■
HEADLAMP WARNING TONE	Headlamps on.	■	■
HEATER	Includes heater with windshield and side window defogger.	■	■
HEATER DUCT	Rear seat area. Located on floor under front seats (Crew Cab models only).	■	■
INSULATION	Provided on dash panel, cowl top and sides, and doors. Extra insulation is provided with diesel engines. Plus insulation on headliners. Plus insulation on Regular Cab Panels.	■ — —	■ ■ ■
LIGHTING	Includes dome, reading, ashtray and glove box.	■	■
MIRRORS	10-inch rearview.	■	■
RADIOS	ETR AM/FM stereo radio with Seek-Scan and digital clock. Includes two 6" diameter front door mounted speakers and two 4" x 6" rear mounted speakers located at rear above door (4 speakers in all). ETR AM/FM stereo radio with Seek-Scan, digital clock, cassette deck. Includes two 6" diameter front door mounted speakers, and two 4" x 6" rear mounted speakers located at rear above door (4 speakers in all).	■ —	— ■
SEATS	Regular-Cab: Front 3-passenger bench with head restraints and folding backrest. Regular-Cab: Front 3-passenger bench with head restraints and folding center armrest. Power lumbar and front seat-back storage pockets included. Center armrest provides lift-up storage space that features a coin holder, a map net on the inside lid and a writing board. Crew-Cab: Front 3-passenger bench with head restraints and folding backrest and rear 3-passenger bench with folding backrest. Crew Cab: Front 3-passenger bench with head restraints and folding center armrest. Power lumbar and front seat-back storage nets included. Center armrest provides lift-up storage space that features a coin holder, a map net on the inside lid and a writing board. Also includes rear 3-passenger bench with folding backrest. NOTE: Scotchgard™ Protector on all cloth seats and cloth door trim panels.	■ — ■ —	— ■ — ■
STEERING WHEEL	Simulated leather. Leather.	■ —	— ■
STORAGE TRAY	Full width behind seat on floor (N/A 3500HD).	—	■
SUNSHADES	Color-keyed RH and LH padded with cloth covering, storage strap on LH unit and visor mirror on RH unit. Crew-Cab: Padded, color-keyed RH and LH sunshades with extenders and illuminated mirrors. LH sunshade has storage strap.	■ —	■ ■
TOOLS	Mechanical jack and wheel wrench located behind front seat or on rear compartment floor (N/A 3500HD).	■	■
WINDSHIELD WIPERS	Intermittent.	■	■

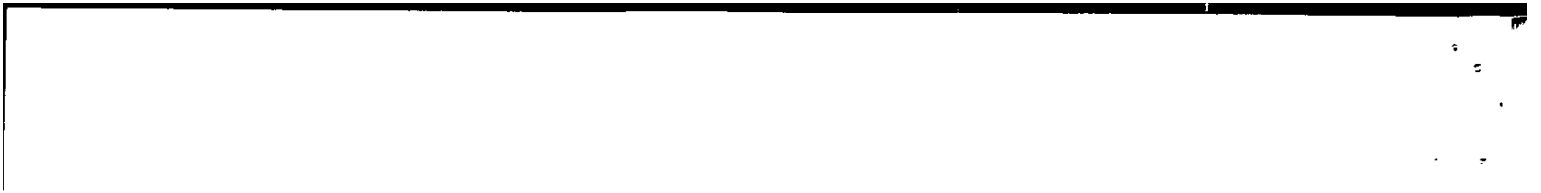

C/K CHASSIS-CAB

PREFERRED EQUIPMENT GROUPS

Preferred Equipment Groups (PEGs) are convenient option packages that can save your customers money. They would pay appreciably more by buying all the options in a Preferred Equipment Group as individual options. (Savings based on a comparison of Manufacturer's Suggested Retail Price of option packages versus MSRP of individual options purchased separately.) See your 1996 Chevrolet Truck Order Guide and Vehicle Price Schedule for specific information and price.

OPTIONS

These options can be ordered individually in addition to the Preferred Equipment Groups if not already included. See your 1996 Chevrolet Truck Order Guide for specific availability and restrictions. The Option Code is listed in **bold type**.

Air Cleaner, High Capacity
(N/A Diesel Engine) **K47**

Air Conditioning **C60**

Appearance Package (Includes Chrome Grille, Composite Halogen Headlamps and Dual Horns) **V22**

Axles, Rear

3.42 **GU6**

3.73 **GT4**

4.10 **GT5**

4.56 **HC4**

4.63 **GK9**

5.13 **HC7**

Axle, Rear Locking Differential
(N/A 3500 HD) **G80**

Axle, Rear Wide Track, 92.2-in.
wide (C/K 31003, 31403 only) **GTY**

Battery, Heavy-Duty Auxiliary
(540 CCA) (N/A 3500 HD
or diesel engine) **TP2**

Cold Climate Package
(includes Engine Block Heater) **V10**

Convenience Group:
Tilt-Wheel™ and Electronic
Speed Control **ZQ3**

Defogger, Rear Window
(Crew-Cab only) **C49**

Emissions:

Federal **FE9**

Massachusetts/New York **NG1**

California **YF5**

Federal Emissions Override **NC7**

Cal./Mass./N.Y. Emissions
Override **NB8**

Engines (see Powertrains)

Vortec 5700 V8 SFI **L31**

Vortec 7400 V8 SFI **L29**

6.5L V8 Turbo Diesel **L65**

Alternative Fuel (LPG and
CNG Conversion-Ready) **KL5**

Equipment, Heavy Duty,
available on C/K 31003/31403
11,000/12,000 GVW only **F44**

Floor Covering, Full-Floor, Rubber,
Color-Keyed (Reqs YE9
Silverado) **BG9**

Carpet (N/A Crew Cab) **B30**

Front Floor Mats (N/A Crew Cab) . **B32**

Fuel Tank, Delete (rear mounted
18-gallon capacity, available on

C/K31003 and C/K31403 and
3500HD only) **NOZ**

Glass, Solar-Ray® Deep Tinted,
(includes light-tinted rear window
when sliding rear window is
specified. Crew Cab only) **AJ1**

GVWR:

8600 lb **C6P**

9000 lb **C6U**

9200 lb **C6W**

10,000 lb **C7A**

11,000 lb **C7E**

12,000 lb **C7L**

15,000 lb **C5B**

Keyless Entry, Remote (Requires
YE9 Silverado) **AU0**

Locks: Power door **AU3**

Lamps, Roof Marker (included w/
Dual Rear Wheels R05) **U01**

License Plate Bracket, Front **VK3**

Marketing Packages
(See Order Guide for details):

Convenience Package **R9A**

Ambulance Package **YF2**

Mirrors:

Electrochromatic (includes
light-sensitive rearview mirror
and eight-point compass.
Requires YE9 Silverado)
N/A 3500 HD **DD7**

Exterior Electric Remote,
Black (available on 20903 and
30903 and Crew Cab models) **D48**

Exterior Below-Eye-Line Type
(LH and RH stainless steel. Mirror
head: 9.0" x 6.5") (N/A on Crew
Cab) (N/A C3500 HD) (available on
C/K 31003, C/K 31403 only) **D45**

Exterior Camper Type
(LH and RH stainless steel.
Mirror head: 7.5" x 10.5") **DF2**

Exterior West Coast Type
(LH and RH stainless steel.
Mirror head: 7.0" x 16.0") **DG5**

Paint, Exterior, Solid **ZY1**

Radio Equipment:

Radio Delete (N/A with YE9
Silverado) **UL5**

ETR AM/FM Stereo Radio
w/Seek-Scan, Stereo Cassette,
Digital Clock **UM6**

ETR AM/FM Stereo Radio with
Seek-Scan with Automatic Tone Control,
Stereo Cassette Deck, Digital Clock,
Theft Lock™ and Speed-Compensated
Volume (with YE9 Silverado includes
an enhanced performance speaker
system)(N/A with 3500 HD) **ULO**

ETR AM/FM Stereo Radio with
Seek-Scan with Automatic Tone Control,
Compact Disk Player, Digital Clock,
Theft Lock™ and Speed-Compensated
Volume (with YE9 Silverado includes
an enhanced speaker system)
(N/A with 3500 HD) **UN0**

ETR AM/FM Stereo Radio with
Seek-Scan with Automatic Tone Control,
Compact Disk Player, Cassette Deck,
Digital Clock, Theft Lock™ and Speed-
Compensated Volume with YE9
Silverado includes an enhanced
performance speaker system)
(N/A with 3500 HD) **UP0**

Seat Type:

Bench Seat **A52**

60/40 Reclining Split Bench Seat
(N/A 3500HD) **AE7**

Reclining High-Back Bucket
Seat (includes center console) **A95**

Seat, Power Driver's (Crew Cab
model with YE9 Silverado) **AG9**

Skid Plate (4WD models only) **NZZ**

Snow Plow Prep Package
(4WD Reg. Cab only) **VYU**

Springs (torsion bars), Front
Heavy-Duty (4x4 only) **F60**

Stabilizer Shaft, Rear
(C/K 31003, 31403 only) **F61**

Tow Hooks, Front (4 x 2 only) **V76**

Transmissions:

5-Speed Manual with Deep Low
Overdrive, HD **MW3**

Electronically Controlled
4-Speed Automatic,
Overdrive, HD **MT1**

Wheels:

Rally Trim (N/A C3500 HD) **P06**

Dual Rear **R05**

Single Rear **R04**

Windows, Sliding Rear **A28**

TIRES

KEY: ALS = ALL-SEASON SBR = STEEL-BELTED RADIAL PLY BW = BLACKWALL HWY = HIGHWAY OOR = ON-OFF ROAD

TIRE DESCRIPTION		FRONT	REAR	SPARE
LT215/85R16D	HWY/SBR/BW	XYK	YYK	ZYK
LT215/85R16D	OOR/SBR/BW	XYL	YYL	ZYL
LT225/75R16C	ALS/SBR/BW	XHE	—	—
LT225/75R16D	ALS/SBR/BW	XHP	YHP	ZHP
LT225/75R16D	OOR/SBR/BW	XHR	YHR	ZHR
LT245/75R16E	ALS/SBR/BW	XHH	YHH	ZHH
LT245/75R16E	OOR/SBR/BW	XGK	YGK	ZGK
225/70R 19.5F (C3500 HD)	HWY/SBR/BW	XTN	YTN	ZTN

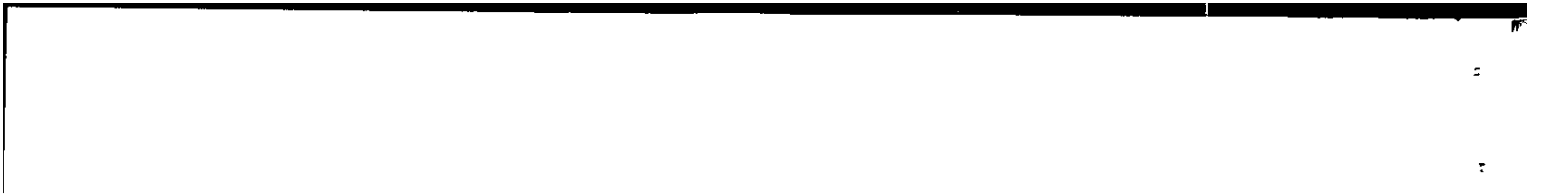

C/K CHASSIS-CAB

DIMENSIONS

MODEL	C/K 2500 CHASSIS- CAB REGULAR- CAB	C/K 3500 CHASSIS-CAB REGULAR CAB		C/K 3500 STRAIGHT FRAME CHASSIS-CAB		C 3500 HD CHASSIS-CAB			CREW CAB CHASSIS-CAB	
MODEL NUMBER	CC/K20903/ ZW9	CC/K30903/ ZW9/R04	CC/K30903/ ZW9/R05	CC/K31003/ ZW9	CC/K31403/ ZW9	CC/31003/ ZW9/CSB	CC31403/ ZW9/CSB	CC31803/ ZW9	CC/K30943/ ZW9/R04	CC/K30943/ ZW9/R05
EXTERIOR DIMENSIONS										
BODY										
Wheelbase (in.) L101	131.5	131.5	131.5	135.5	159.5	135.5	159.5	183.5	168.5	168.5
Overall Length (in.) L103	208.6	208.6	208.6	221.9	245.9	224.5	248.5	272.6	246.1	246.1
Overall Height (in.) 2WD 4WD H431	75.5 75.8	75.5 75.8		75.5 75.8	75.5 75.8	75.5 —	75.5 —	75.5 —	71.7 73.8	68.3 70.2
Maximum Width (in.) W103	76.8	76.8	92.2	84.2	84.2	84.2	84.2	85.8	76.8	94.3
Bumper to Axle Frt (in.) L104	35.4	35.4	35.4	35.4	35.4	37.9	37.9	37.9	35.4	35.4
Rear Axle to End of Frame (in.) L105	41.7	41.7	41.7	51.0	51.0	51.0	51.0	51.0	41.7	41.7
Cab to Rear Axle (in.) L404	55.9	55.9	55.9	60.0	84.0	60.0	84.0	108.0	55.9	55.9
Cab to End of Frame (in.) L103 L403	97.6	97.6	97.6	111.0	135.0	111.0	135.0	159.0	97.6	97.6
Bumper to Back of Cab (in.) L403	111.0	111.0	111.0	111.0	111.0	113.6	113.6	113.6	148.5	148.5
Ground to Top of Frame (in.) ¹ 2WD 4WD	30.4 32.4	31.8 31.6	32.4 31.6	31.0 31.9	31.0 31.9	33.1 —	33.3 —	33.3 —	30.9 31.2	31.1 31.0
Ground Clearance (in.) Front-2WD Front-4WD H148 Rear-2WD Rear-4WD H153	7.1 8.7 7.3 7.3	8.4 6.3 6.4 6.4	8.4 6.3 6.4 6.4	8.9 5.8 6.4 6.4	8.9 5.8 6.4 6.4	8.9 — 6.4 —	8.9 — 6.4 —	10.8 — 6.4 —	7.5 7.3 6.4 6.4	7.5 7.3 6.4 6.4
Frame Width (in.) Over Rails Front/Rear	45.3/36.7	45.3/36.7	45.3/36.7	45.3/34.0	45.3/34.0	45.3/34.0	45.3/34.0	41.3/34.0	45.3/36.7	45.3/36.7
Turning Diameter Curb-to-Curb (ft) 2WD 4WD	43.4 44.7	43.4 44.7	43.4 44.7	44.5 45.9	51.4 52.7	46.0 —	52.9 —	59.9 —	53.8 55.4	53.8 55.4
SIGN PANEL AREA (in.)	17 X 48.75	17 X 48.75	17 X 48.75	17 X 48.75	17 X 48.75	17 X 48.75	17 X 48.75	17 X 48.75	17 X 85	17 X 85

¹Measured at centerline of rear axle.

INTERIOR DIMENSIONS										
CAB										
Headroom (in.) Front H61 Rear H63	39.9 —	39.9 —	39.9 —	39.9 —	39.9 —	39.9 —	39.9 —	39.9 —	39.9 40.8	39.9 40.8
Legroom (in.) Front L34 Rear L51	41.7 —	41.7 —	41.7 —	41.7 —	41.7 —	41.7 —	41.7 —	41.7 —	41.7 37.9	41.7 37.9
Shoulder Room (in.) Front W3 Rear W4	65.4 —	65.4 —	65.4 —	65.4 —	65.4 —	65.4 —	65.4 —	65.4 —	65.4 64.9	65.4 64.9
Hip Room (in.) Front W5 Rear W6	60.0 —	60.0 —	60.0 —	60.0 —	60.0 —	60.0 —	60.0 —	60.0 —	60.0 59.3	60.0 59.3



1500 PICKUP EQUIPMENT SUMMARY

STANDARD INTERIOR FEATURES		X81	CHEYENNE	SILVERADO
AIR BAG:	DRIVER'S SIDE	S	S	S
CUPHOLDERS:	DUAL IN DASH	S	S	S
DOOR BEAMS:	SIDE IMPACT	S	S	S
GAGES:	TRIP ODOMETER, OIL PRESSURE, VOLTMETER AND TACHOMETER	S	S	S
GLASS:	SOLAR RAY TINTED, ALL WINDOWS	S	S	S
JACK:	WITH WHEEL WRENCH	S	S	S
INSULATION:	UNDER DASH & FLOOR COVERING	S	S	S
LIGHTING:	DOME W/LH & RH DOOR SWITCH <u>W/DELAYED ENTRY FEATURE</u> , READING ASHTRAY, GLOVE-BOX, UNDERHOOD & CARGO LAMPS	S	S	S
POWER POINTS:	DUAL COVERED	S	S	S
SCOTCHGARD:	ALL CLOTH AND CARPET SURFACES	S	S	S
<u>SEAT BELTS:</u>	<u>ADJUSTABLE HEIGHT, FRONT</u>	S	S	S
WARNING TONE:	KEY-IN-IGNITION BUZZER	S	S	S
STANDARD EXTERIOR FEATURES		X81	CHEYENNE	SILVERADO
AIR DAM:	DARK ARGENT	S	S	S
<u>LAMPS:</u>	<u>DAYTIME RUNNING</u>	S	S	S
SPARE TIRE:	FULL SIZE TIRE & WHEEL, W/WINCH TYPE CARRIER MOUNTED UNDER REAR FRAME	S	S	S
TAILGATE:	REMOVABLE	S	S	S
TOW HOOKS:	TWO FRONT ON 4X4 MODELS	S	S	S
WIPERS:	INTERMITTENT WINDSHIELD W/PULSE WASHERS	S	S	S
WIRE HARNESS:	7 WIRE TRAILERING	S	S	S
WINDOW:	REAR QUARTER SWING-OUT (EXT CAB ONLY)	--	S	S
STANDARD CHASSIS FEATURES		X81	CHEYENNE	SILVERADO
BATTERY:	HEAVY-DUTY 600 CCA	S	S	S
BRAKES:	POWER ASSISTED FRONT DISC, REAR DRUM 4-WHEEL ANTI-LOCK	S	S	S
<u>ENGINE:</u>	<u>VORTEC 4300 V6 SFI</u>	S	S	S
	<u>VORTED 5000 V8 SFI ON K10953</u>	S	S	S
<u>EXHAUST SYSTEM:</u>	<u>STAINLESS STEEL</u>	S	S	S
FUEL TANK:	25 GAL W/SHORT BOX MODELS	S	S	S
	34 GAL W/LONG BOX MODELS	S	S	S
GENERATOR:	100 AMP	S	S	S
<u>STORAGE BOX:</u>	<u>UNDERHOOD, COVERED</u>	S	S	S
SUSPENSION FRT:	INDEPENDENT COIL W/2WD	S	S	S
	INDEPENDENT TORSION BAR W/4X4	S	S	S
SUSPENSION RR:	MULTI-LEAF SPRINGS	S	S	S
TRANSMISSION:	5-SPEED MANUAL, W/OVERDRIVE	S	S	S

BOLD, ITALICS AND UNDERLINED INDICATES NEW FOR '96

REVISED: 1-29-96

1996 ORDER GUIDE

C/K 1500 PICKUP

Page 1

Prices Shown Are Manufacturer's Suggested Retail Prices (MSRP) At The Time Of Publication. These Prices Are To Be Used Only As An Aid To Inventory Management Since MSRP Figures Change Periodically. The Vehicle Price Schedule Is The Official Pricing Documentation Of Chevrolet Motor Division And Should Be Used In Discussing Vehicle Prices With Potential Buyers. The Model Prices Shown In The Order Guide Include The Destination Freight Charges.

**1500 PICKUP
TRIM DEFINITION & OPTION SUMMARY**

INTERIOR TRIM		X81	CHEYENNE	SILVERADO
AIR CONDITIONING:		O	O	S
ASSIST HANDLES:	PASSENGER	S	S	S
CONVENIENCE GP:	POWER WINDOWS, LOCKS	--	--	S
	TILT WHEEL AND CRUISE CONTROL	O	O	S
DOOR TRIM:	MOLDED PLASTIC W/ARMREST	S	S	--
	COLOR-KEYED CLOTH AND CARPET TRIMMED	--	--	S
FLOOR COVERING:	FULL BLACK RUBBER	S	--	--
	COLOR-KEYED CARPET	--	O	S
	COLOR-KEYED RUBBER	--	S	O
	RUBBER FLOOR MATS	--	O	S
HEADLINER:	VINYL	S	--	--
	COLOR-KEYED CLOTH	--	S	S
INSULATION:	ADDITIONAL SOUND-DEADENING	--	--	S
MAP POCKETS:	IN PASSENGER AND DRIVER'S DOOR	S	S	S
RADIO:	AM/FM STEREO W/SEEK-SCAN AND CLOCK	S	S	--
	AM/FM STEREO W/SEEK-SCAN, CLOCK AND CASSETTE TAPE	O	O	S
SEATING:	CLOTH BENCH	O	O	S
	VINYL BENCH (N/A EXT CAB)	S	S	O
	CLOTH 60/40 SPLIT BENCH (EXT CAB)	O	O	S
	VINYL 60/40 SPLIT BENCH (EXT CAB)	--	S	O
STEERING WHEEL:	SIMULATED LEATHER	S	S	--
	LEATHER WRAPPED	--	--	S
STORAGE TRAY:	FULL WIDTH BEHIND SEAT	--	--	S
SUNSHADES	CLOTH COVERED W/LH STORAGE STRAP W/RH MIRROR	S	S	S

EXTERIOR TRIM		X81	CHEYENNE	SILVERADO
BUMPER FRT:	CHROME	S	S	--
	CHROME W/BLACK RUB STRIP	--	O	S
BUMPER RR:	CHROME W/STEP PAD	--	O	S
GRILLE:	MOLDED, PAINTED ARGENT	S	S	--
	CHROME DELUXE	--	O	S
HEADLAMPS:	SINGLE RECTANGULAR HALOGEN	S	S	--
	DUAL COMPOSITE - HALOGEN	--	O	S
HORN:	SINGLE NOTE	S	S	--
	DUAL NOTE	--	O	S
MIRRORS:	BREAK-A-WAY OSRV, BLACK	S	S	--
	ELECTRIC, REMOTE CONTROL, BLACK	--	--	S
MOLDINGS:	BODY SIDE WITH BRIGHT TRIM AND BRIGHT WHEEL OPENING TRIM	--	O	S
NAMEPLATES:	W/T DECAL ON TAILGATE	S	--	--
	CHEYENNE BADGE ON B-PILLAR	--	S	--
	SILVERADO BADGE ON B-PILLAR	--	--	S
PAINT:	SINGLE TONE	S	S	S
WHEELS:	SILVER PAINTED W/BLACK CENTER CAP	S	S	--
	RALLY WHEEL TRIM	O	O	S

BOLD, ITALICS AND UNDERLINED INDICATES NEW FOR '96

C/K 1500 PICKUP

1996 ORDER GUIDE

REVISED: 1-29-96

Page 2

Prices Shown Are Manufacturer's Suggested Retail Prices (MSRP) At The Time Of Publication. These Prices Are To Be Used Only As An Aid To Inventory Management Since MSRP Figures Change Periodically. The Vehicle Price Schedule Is The Official Pricing Documentation Of Chevrolet Motor Division And Should Be Used In Discussing Vehicle Prices With Potential Buyers. The Model Prices Shown In The Order Guide Include The Destination Freight Charges.

MODEL AND BODY

Description	Model No	Body	Wheel Base
2-WHEEL-DRIVE MODELS			
Sportside	CC10703	E62	117.5
Fleetside	CC10703	E63	117.5
Fleetside	CC10703	E63 & X81	117.5
Fleetside	CC10903	E63	131.5
Fleetside	CC10903	E63 & X81	131.5
Sportside, Ext Cab ..	CC10753	E62	141.5
Fleetside, Ext Cab ..	CC10753	E63	141.5
Fleetside, Ext Cab ..	CC10953	E63	155.5

Description	Model No	Body	Wheel Base
4-WHEEL-DRIVE MODELS			
Sportside	CK10703	E62	117.5
Fleetside	CK10703	E63	117.5
Fleetside	CK10703	E63 & X81	117.5
Fleetside	CK10903	E63	131.5
Fleetside	CK10903	E63 & X81	131.5
Sportside, Ext Cab ..	CK10753	E62	141.5
Fleetside, Ext Cab ..	CK10753	E63	141.5
Fleetside, Ext Cab ..	CK10953	E63	155.5

*Includes Destination & Handling Charges

EMISSIONS (Must Specify One) (Refer Emission Requirements Section)

- FE9 Federal Emission Requirements
- YF5 California Emission Requirements
- NG1 New York/Massachusetts Emission Requirements
- NB8 California or New York/Massachusetts Emission Override (Reqs FE9 Federal Emissions)
- NC7 Federal Emission Override (Reqs YF5 California or NG1 New York/Massachusetts Emissions)

***GVWR SELECTOR (Must Specify GVW Option)**

Minimum Equipment Required for GVW Rating				
GVW Option Required	GVW Rating (lbs)	GAWR*		
		Front	Rear	
C10703-C10903				
C5M	6100	3150	3686	X81 Reqs L35 Eng
K10703-K10903				
C5M	6100	3600	3750	X81 Reqs L35 Eng
C10753-C10953				
Q4B	6200	3500	3686	None
K10753-K10953				
Q4B	6200	3600	3750	N/A F44 Chassis or L56 Eng
C5S	6600	3600	3750	Reqs F44 (N/A L56 Eng w/K10953)
C5U	6800	3600	3750	Reqs L56 Eng (N/A K10753)

*GAWR's shown are the minimum for each axle with equipment listed. Other GAWR's are available, and they are determined as the minimum capacity of either axle, springs or tires.

POWER TEAMS (Must Specify Engine, Transmission and Rear Axle)

(Consult GVWR Selector For Minimum Equipment Required)

ENGINE	TRANSMISSION		AXLES			GVWR
	5-SP Manual Lt Duty / H Duty	4-Speed AUTO Lt Duty	3.08	3.42	3.73	
CC10703						
L35 Vortec 4300 V6 (262 Cu In)--SFI	MG5	M30	GU4	GU6		6100
L30 Vortec 5000 V8 (305 Cu In)--SFI	MG5	M30	(a) GU4	(a) GU6	--	6100
L31 Vortec 5700 V8 (350 Cu In)--SFI	M50	M30	GU4	GU6	--	6100
			GU4	GU6	GT4	6100
CK10703						
L35 Vortec 4300 V6 (262 Cu In)--SFI	MG5	M30	--	--	GT4	6100
L30 Vortec 5000 V8 (305 Cu In)--SFI	MG5	M30	--	(a) GU6	(a) GT4	6100
L31 Vortec 5700 V8 (350 Cu In)--SFI	M50	M30	--	GU6	GT4	6100

(a) N/A YF5 California Emissions

CONTINUED ON PAGE 5

POWER TEAMS (Continued)

(Consult GVWR Selector For Minimum Equipment Required)

ENGINE	TRANSMISSION		AXLES			GVWR
	5-SP Manual Lt Duty / H Duty	4-Speed AUTO Lt Duty / H Duty	3.08	3.42	3.73	
CC10903						
L35 Vortec 4300 V6 (262 Cu In)--SFI	MG5	M30	GU4	GU6	--	6100
L30 Vortec 5000 V8 (305 Cu In)--SFI	MG5	M30	(a) GU4	(a) GU6	--	6100
L31 Vortec 5700 V8 (350 Cu In)--SFI	M50	M30	GU4	GU6	--	6100
L56 Turbo Diesel V8 6.5 Liter (400 Cu In)		MT1	(a) GU4	(a) GU6	--	6100
CK10903						
L35 Vortec 4300 V6 (262 Cu In)--SFI	MG5	M30	--	--	GT4	6100
L30 Vortec 5000 V8 (305 Cu In)--SFI	MG5	M30	--	(a) GU6	(a) GT4	6100
L31 Vortec 5700 V8 (350 Cu In)--SFI	M50	M30	--	GU6	GT4	6100
L56 Turbo Diesel V8 6.5 Liter (400 Cu In)		MT1	--	(a) GU6	(a) GT4	6100

(a) N/A YF5 California Emissions

CONTINUED ON PAGE 6

C/K 1500 PICKUP

POWER TEAMS (Continued)

(Consult GVWR Selector For Minimum Equipment Required)

ENGINE	TRANSMISSION		AXLES			GVWR
	5-SP Manual Lt Duty	4-Speed AUTO Lt Duty / H Duty	3.08	3.42	3.73	
CC10753						
L35 Vortec 4300 V6 (262 Cu In)--SFI	MG5	M30	--	GU6	--	6200
L30 Vortec 5000 V8 (305 Cu In)--SFI	MG5	M30	(a) GU4	(a) GU6	--	6200
L31 Vortec 5700 V8 (350 Cu In)--SFI	M50	M30	GU4	GU6	--	6200
L56 Turbo Diesel V8 6.5 Liter (400 Cu In)		M30	GU4	GU6	GT4	6200
CK10753						
L35 Vortec 4300 V6 (262 Cu In)--SFI	MG5	M30	--	--	(a) GT4	6200/6600
L30 Vortec 5000 V8 (305 Cu In)--SFI	MG5	M30	--	(a) GU6	(a) GT4	6200/6600
L31 Vortec 5700 V8 (350 Cu In)--SFI	M50	M30	--	GU6	GT4	6200/6600
L56 Turbo Diesel V8 6.5 Liter (400 Cu In)		MT1	--	(a) GU6	(a) GT4	6600

(a) N/A YF5 California Emissions

CONTINUED ON PAGE 7

POWER TEAMS (Continued)

(Consult GVWR Selector For Minimum Equipment Required)

ENGINE	TRANSMISSION		AXLES			GVWR
	5-SP Manual Lt Duty / H Duty	4-Speed AUTO Lt Duty / H Duty	3.08	3.42	3.73	
CC10953						
L30 Vortec 5000 V8 (305 Cu In)--SFI	MG5		(a) GU4	(a) GU6	--	6200
		M30	GU4	GU6	--	6200
L31 Vortec 5700 V8 (350 Cu In)--SFI	M50		GU4	GU6	--	6200
		M30	GU4	GU6	GT4	6200
L56 Turbo Diesel V8 6.5 Liter (400 Cu In)		MT1	(a) GU4	(a) GU6	--	6200
CK10953						
L30 Vortec 5000 V8 (305 Cu In)--SFI	MG5		--	(a) GU6	(a) GT4	6200/6600
		M30	--	GU6	GT4	6200/6600
L31 Vortec 5700 V8 (350 Cu In)--SFI	M50		--	GU6	GT4	6200
	M50		--	(a) GU6	GT4	6600
		M30	--	GU6	GT4	6200/6600
L56 Turbo Diesel V8 6.5 Liter (400 Cu In)		MT1	--	(a) GU6	(a) GT4	6800

(a) N/A YF5 California Emissions

C/K 1500 PICKUP

CAPACITIES

C10703-C10903	
SPRINGS:	
Front	3200
Rear	3750
AXLES:	
Front	3150
Rear	3750

K10703	
SPRINGS:	
Front	3600
Rear	3750
AXLES:	
Front	3925
Rear	3750

K10903	
SPRINGS:	
Front	3600
Rear	3750
AXLES:	
Front	3925
Rear	3750

C10753-C10953			
SPRINGS:		AXLES:	
Front	3500 Base	Front	3600
Rear	3750	Rear	3750

K10753-K10953			
SPRINGS:		AXLES:	
Front	3600	Front	3925
Rear	3750	Rear	3750

TIRES: (Must Specify Front and Rear) (Spare Tire Included)

Description	All Season		All Terrain		On-Off Road	
	Front	Rear	Front	Rear	Front	Rear
C10703-C10903						
TUBELESS Steel Belted Radial						
P235/75R15 B/W	XFL	YFL				
(a) P235/75R15 W/L	XFN	YFN				
K10703-K10903						
TUBELESS Steel Belted Radial						
P245/75R16 B/W			XGA	YGA		
P245/75R16 WOL			XGB	YGB		
LT245/75R16-C B/W					XBN	YBN
LT245/75R16-C WOL					XBX	YBX
(b) P265/75R16 B/W					XGC	YGC
(b) P265/75R16 WOL					XGD	YGD
C10753-C10953						
TUBELESS Steel Belted Radial						
P235/75R15 B/W	XFL	YFL				
P235/75R15 W/L	XFN	YFN				
K10753-K10953						
TUBELESS Steel Belted Radial						
P245/75R16 B/W			XGA	YGA		
P245/75R16 WOL			XGB	YGB		
LT245/75R16-C B/W					XBN	YBN
LT245/75R16-C WOL					XBX	YBX
(b) P265/75R16 B.W					XGC	YGC
(b) P265/75R16 WOL					XGD	YGD

- (a) N/A X81 Work Pkg
- (b) Reqs PF4 Wheels; Also Reqs GT4 Axle w/c L31 Eng ; N/A X81 Work Pkg

B/W=Blackwall
W/L=White Lettered
WOL=White Outlined Letter

C/K 1500 PICKUP

MUST SPECIFY:

AXLE, EMISSION, ENGINE, TIRES AND TRANSMISSION

**No Deletions Allowed. Additional Options/Upgrades (Where Indicated)
May be Ordered from the Custom Ordering Option Listing.**

REG & EXT CAB DECOR

	* X81	CHEYENNE	SILVERADO	
	1 S W	1 S A	1 S B	1 S C
WORK TRUCK DECOR	X81	X	--	--
Fleetside Body Code without BYP Sport Package (A)	E63	X	X	X
CHEYENNE DECOR		X	--	--
SILVERADO DECOR	YE9		X	X
Air Conditioning			X	X
Radio: AM/FM Stereo w/Cassette (B)			X	X
Tilt and Cruise			X	X
SILVERADO DECOR (Leather)				
Regular Cab				
Extended Cab				
Keyless Entry	AU0			X
Mirror, Electrochromic ISRV w/8 Point Compass	DD7			X
Seat, Power (D)	AG9			X
Trim, Leather (C)	AE7			X

- * 1SW PEG N/A Extended Cab
- (A) May Substitute E62 Sportside on Cheyenne or Silverado Decor w/o X81 Work Truck
- (B) May upgrade --
- (C) Must Specify Trm Color. May Upgrade to A95 Seat on Extended Cab
- (D) Extended Cab Only

Preferred Equipment Group Prices

- 1SW**
- PEG Savings**
- w/MG5

- 1SA**
- PEG Savings**
- w/MG5 or M50 & R9A & R9B
- w/MG5 or M50 & R9A
- w/MG5 or M50 & R9B
- w/M30 or MT1 & R9A & R9B
- w/MG5 or M50
- w/M30 or MT1 & R9A
- w/M30 or MT1 & R9B
- w/M30 or MT1

Preferred Equipment Group Prices

- 1SB or 1SC**
- PEG Savings**
- w/MG5 or M50
- w/M30 or MT1

**PEG Savings Amount represents the savings for Preferred Equipment Groups.

REGULAR CAB MARKETING PACKAGES

CONVENIENCE PACKAGE

ORDERING OPTION=R9A

(Reqs Peg 1SA)

Incls :

- C60 Air Conditioning
- ZQ3 Tilt and Cruise
- UM6 Radio w/Cassette

BRIGHT APPEARANCE PACKAGE

ORDERING OPTION=R9B

(Reqs Peg 1SA)

Incls :

- B85 Body Side Molding
- V22 Chrome Grille
- VB3 Chrome Rear Step Bumper
- VG3 Chromed Front Bumper
- P06 Rally Wheels (Upgrade Allowed)

SPORT PACKAGE

ORDERING OPTION=BYP

(Reqs C-K10703 And Peg 1SB/1SC)

(Refer Page 19 For Color/ Trim Availability)

Incls :

- Body Color Front & Rear Bumper
- Fog Lamps and Sport Identification Decals
- Non-Electric Color-Keyed Mirror
- N90/PF4 Aluminum Wheels
(N83 Chrome Wheels may be substituted)
- BYP Sport Pkg
- E62 Sportside Body
- XFL, YFL on C10703
- XGC, YGC on K10703
- N/A VYU Snow Plow or F60 Springs

EXTENDED CAB MARKETING PACKAGES

CONVENIENCE PACKAGE

ORDERING OPTION=R9A

(Reqs Peg 1SA)

Incls :

- C60 Air Conditioning
- ZQ3 Tilt and Cruise
- UM6 Radio w/Cassette

BRIGHT APPEARANCE PACKAGE

ORDERING OPTION=R9B

(Reqs Peg 1SA)

Incls :

- B85 Body Side Moldings
- V22 Chrome Grille
- VB3 Chrome Rear Step Bumper
- VG3 Chromed Front Bumper
- P06 Rally Wheels (Upgrade Allowed)

X81 WORK TRUCK 1500 PICKUP

ADDITIONAL OPTIONS

OPTION

	ACKNOWLEDGEMENTS:
R8S	Multiple Order Numbers
R8T	Preliminary Invoice (Refer Vehicle Price Schedule for Prices)
K47	AIR CLEANER: High Capacity
C60	AIR CONDITIONING: (Incls R134A Refrigerant)
	AXLES, REAR: (Refer Power Teams Chart for Availability)
GU4	3.08 Ratio
GU6	3.42 Ratio
GT4	3.73 Ratio
G80	Locking Differential (N/A GU4 Axle)
BZY	BEDLINER: Under Rail
E63	BODY CODE: 8 Ft. Fleetside
V43	BUMPER: Painted, Rear Step
V10	COLD-CLIMATE PACKAGE: (Incls Eng Block Heater)
ZQ3	CONVENIENCE PACKAGE: Cruise and Tilt
KC4	COOLER: Engine Oil (Engine Oil Cooler comparable to KC4 is standard w/GT4 Axle) (N/A GT4 Axle) w/Z82 w/o Z82
	EMISSIONS: (Refer Emission Requirements Tab Section)
FE9	Federal Emission Requirements
YF5	California Emission Requirements w/L35 or L31 and M30 w/o L35 or L31 and M30
NG1	New York/Massachusetts Emission Requirements
N88	California Emission or New York/Massachusetts Override (Reqs FE9 Federal Emissions)
NC7	Federal Emission Override (Reqs YF5 California or NG1 New York/Massachusetts Emissions)
L35	ENGINE: Vortec 4300 V6 (262 Cu In)--SFI (Refer Power Teams Chart for Availability)
C5M	GVWR: 6100# (Must Specify) (Refer GVWR Selector Chart for Availability)
VK3	LICENSE PLATE BRACKET: Front
ZY1	PAINT, EXTERIOR: Solid (Refer Color/Trim Chart for Availability)
	RADIO EQUIPMENT:
UM6	Electronically Tuned AM/FM Stereo Radio w/Seek-Scan, Stereo Cassette Tape and Digital Clock
UL5	Radio Delete
A52	SEAT: Bench Seat
	SHOCK ABSORBERS:
FG5	Front and Rear, Gas, 46MM, Bilstein (N/A K1500)
F51	Front and Rear, Heavy Duty (Incl w/VYU Snow Plow Pkg) w/VYU or Z82 w/o VYU or Z82
NZZ	SKID PLATE: Off-Road (K1500 Only) (Incls Engine Front Differential and Transfer Case Shield)
VYU	SNOW PLOW PREP PACKAGE: (K10903 Only) (Incls F60 Front Springs and F51 HD Shock Absorbers)
F60	SPRINGS, FRONT: Heavy Duty (K10903 Only) (Incl w/VYU Snow Plow) w/VYU w/o VYU
	TIRES: (Refer to Tire Chart for Availability and vehicle Price Schedule for Prices)
V76	TOW HOOKS: Two Front (Std on K1500)
Z82	TRAILERING SPECIAL EQUIPMENT: Heavy-Duty (Incls Trailer Hitch, F51 Shocks and KC4 Eng Oil Cooler) (Reqs M30 Trans) (C-K10903 Reqs V43 Bumper) (N/A GU4 Axle) w/VYU w/o VYU
	TRANSMISSION: (Refer Power Teams Chart for Availability)
MG5	5-Speed Manual with Overdrive, Light Duty
M30	4-Speed Electronically Controlled Automatic with Overdrive
	TRIM CODE: (Refer Color/Trim Chart for Availability)
	WHEEL TRIM:
P06	Rally Wheel Trim
N83	Chrome Wheel (C1500 Only)
A28	WINDOWS: Sliding Rear

C/K 1500 PICKUP CHEYENNE/SILVERADO

ADDITIONAL OPTIONS

INCL W/DECOR		OPTION
CHEY- ENNE	SILVER- ADO	
		ACKNOWLEDGEMENTS: R8S Multiple Order Numbers R8T Preliminary Invoice (Refer Vehicle Price Schedule for Prices)
	x	K47 AIR CLEANER: High Capacity (N/A L56 Eng) C60 AIR CONDITIONING: (Incls R134A Refrigerant) w/1SB or 1SC or R9A w/1SA
	x	V22 APPEARANCE PACKAGE: (Incls Chrome Grille, Composite Halogen Headlamps and Dual Horns) w/1SB or 1SC or R9B w/1SA
		AXLES, REAR: (Refer Power Teams Chart for Availability) GU4 3.08 Ratio GU6 3.42 Ratio GT4 3.73 Ratio G80 Locking Differential (N/A GU4 Axle)
		TP2 BATTERY: Auxiliary (Reqs L30 or L31 Eng) (N/A w/BYP Pkg) (Deletes Underhood Storage Box) BZY BEDLINER: Under Rail (Reqs E63 Body)
		BODY CODE: E62 Sportside Body E63 Fleetside Body
N/A		BUMPER EQUIPMENT: EF1 Bumper Delete Provisions: (N/A Z82 Trailering) VB3 Bumper, Chromed. Rear Step w/Rub Strp (Reqs VG3 Bumper or Silverado Decor) (N/A BYP Pkg) w/1SB or 1SC or R9B w/o 1SA w/o R9B
	x	VG3 Bumper, Chromed. Front Deluxe w/Rub Strp (N/A BYP Pkg) w/1SB or 1SC or R9B w/o 1SA w/o R9B
	N/A	V43 Bumper, Painted. Rear Step (Reqs E63 Body) w/BYP w/o BYP
		CHASSIS EQUIPMENT: F44 Heavy-Duty (K1500 Extended only) (Reqs C55 #6600 GVW) (Incl w/L56 Eng) w/Diesel Eng w/o Diesel Eng
N/A		Z71 Off-Road Package (K1500 Only) (Reqs XGC, XGD, XBN or XBX Tires) (Incls NZZ Skid Plate) (N/A F51 Shocks)
	x	V10 COLD-CLIMATE PACKAGE: (Diesel Eng Reqs Base Decor and Reg Cab) (Incls Eng Block Heater) ZQ3 CONVENIENCE GROUP: Tilt Wheel and Speed Control w/1SB or 1SC or R9A w/1SA w/o R9A
		COOLING SYSTEM: KC4 Cooler: Engine Oil (Engine Oil Cooler comparable to KC4 is standard w/GT4 Axle and/or Diesel Eng) (K107*3/K10903 Reqs L30 or L31 Eng) (N/A Diesel Eng or GT4 Axle) w/Z82 w/o Z82
		KNP Transmission, Heavy-Duty, Auxiliary (Reqs Auto Trans) (N/A L35 or L30 Eng) (L31 Eng and M30 Trans N/A GU4 Axle) (Incl w/Z82 Trailering when L31 Eng w/o GU4 or L56 Eng, w/Automatic Trans are specified Also, Included w/MT1 Trans)
N/A		C49 DEFOGGER: Rear Window Electric (N/A A28 Window) (N/A C-K10*03)
		EMISSIONS: (Refer Emission Requirement Tab Section) FE9 Federal Emission Requirements YF5 California Emission Requirements w/L31/L35 & M30 w/o L31/L35 & M30
		NG1 New York/Massachusetts Emission Requirements NB8 California or New York/Massachusetts Emission Override (Reqs FE9 Federal Emissions) NC7 Federal Emission Override (Reqs YF5 California or NG1 New York/Massachusetts Emissions)
		ENGINES: (Refer Power Teams Chart for Availability) L35 Vortec 4300 V6 (262 Cu In)--SF1 L30 Vortec 5000 V8 (305 Cu In)--SF1 w/C/K10953 w/o C/K10953
		L31 Vortec 5700 V8 (350 Cu In)--SF1 w/C/K10953 w/o C/K10953
		L56 6.5 Liter V8 Turbo Diesel (400 Cu In) (Deletes Underhood Storage Box) w/C/K10953 w/o C/K10953

REVISED: 1-29-96

1996 ORDER GUIDE

C/K 1500 PICKUP

Page 13

Prices Shown Are Manufacturer's Suggested Retail Prices (MSRP) At The Time Of Publication. These Prices Are To Be Used Only As An Aid To Inventory Management Since MSRP Figures Change Periodically. The Vehicle Price Schedule Is The Official Pricing Documentation Of Chevrolet Motor Division And Should Be Used In Discussing Vehicle Prices With Potential Buyers. The Model Prices Shown In The Order Guide Include The Destination Freight Charges.

C/K 1500 PICKUP CHEYENNE/SILVERADO

ADDITIONAL OPTIONS

INCL W/DECOR		OPTION	
CHEY- ENNE	SILVER- ADO		
N/A		BG9	FLOOR COVERING: Full Floor, Rubber, Color-Keyed (Replaces Carpeting and Floor Mats) (N/A BYP Sport Pkg) w/C-K10*03 w/C-K10*53
	N/A	B30	Carpet Floor Covering w/C-K10*03 w/C-K10*53
	N/A	B32	Floor Mats (Reqs B30 Floor Covering)
	N/A	B33	Floor Mats (N/A YG4 Seat Delete) (Reqs B30 Carpet, B32 Floor Mats and C-K**53)
		AJ1	GLASS: Deep Tinted Solar-Ray (N/A C-K10*03) (w/A28 Window or C49 Defogger is Specified, Rear Window is Light Tint Glass) w/A28 or C49 w/o A28 or C49
			GVWR: (Must Specify One) (Refer GVWR Selector Chart for Availability)
		C5M	6100#
		Q4B	6200#
		C5S	6600#
		C5U	6800#
N/A		AU0	KEYLESS ENTRY: Remote w/1SC w/o 1SC
	N/A	VK3	LICENSE PLATE BRACKET: Front
		AU3	LOCKS: Power door
			MIRRORS:
		DF2	Camper Type, Stainless Steel 7.5" W x 10.5" H, Exterior w/1SC w/o 1SC
N/A		DD7	10" Electrochromic ISRV with 8 Point Compass, Interior w/1SC w/1SB
	x	B85	MOLDING: Exterior, Bright (Incls Bright Wheel Opening w/E63 Fleetside) (N/A BYP PKG) w/1SB or 1SC or R9B w/E62 and 1SA w/o R9B w/E63 and 1SA w/o R9B
			PAINT, EXTERIOR: (Refer Color/Trim Chart for Availability)
		ZY1	Solid
N/A		ZY2	Conventional Two-Tone
N/A		ZY4	Deluxe Two-Tone (N/A E62 Body)
	x	UM6	RADIO EQUIPMENT: Electronically Tuned AM/FM Stereo Radio w/Seek-Scan, Stereo Cassette Tape and Digital Clock w/1SB or 1SC or R9A w/1SA
N/A		UL0	Electronically Tuned AM/FM Stereo Radio w/Seek-Scan w/Automatic Tone Control, Digital Clock Cassette Tape, Theft Lock and Speed Compensated Volume (w/Silverado Decor Incls an Enhanced Performance Speaker System)
N/A		UN0	Electronically Tuned AM/FM Stereo Radio w/Seek-Scan w/Automatic Tone Control, Compact Disc Player, Digital Clock, Theft Lock and Speed Compensated Volume (w/Silverado Decor Incls an Enhanced Performance Speaker System)
N/A		UP0	Electronically Tuned AM/FM Stereo Radio w/Seek-Scan w/Automatic Tone Control, Compact Disc Player, Digital Clock, Cassette Tape, Theft Lock and Speed Compensated Volume) (w/Silverado Decor Incls an Enhanced Performance Speaker System) (Reqs M30 or MT1 Trans)
	N/A	UL5	Radio Delete
N/A		AG9	SEAT: Power Driver's Seat (N/A Vinyl Trim or A52 Bench Seat) (N/A C-K 10*03) w/1SC w/o 1SC
	N/A	YG4	SEAT DELETE: Rear (N/A C-K10*03)
			SEAT TYPE: (Refer Color/Trim Chart for Availability)
		A52	Bench Seat (Incls Storage Armrest and Power Lumbar w/Custom Cloth or Leather Trim) w/o Leather w/Leather
		AE7	Reclining 60/40 Split Bench Seat (Incls Storage Armrest and Power Lumbar w/Custom Cloth or Leather Trim) w/1SC Extended Cab w/1SA or 1SB w/o Leather w/1SB and Leather Regular Cab w/1SA or 1SB w/o Leather w/1SB and Leather

C/K 1500 PICKUP CHEYENNE/SILVERADO

ADDITIONAL OPTIONS

INCL W/DECOR		OPTION
CHEY- ENNE	SILVER- ADO	
		SEAT TYPE: (Continued) A95 Reclining High Back Bucket Seats (Incls Power Lumbar) Extended Cab w/1SC w/1SB and Cloth w/1SB and Leather Regular Cab w/1SC w/1SB and Cloth w/1SB and Leather
		SHOCK ABSORBERS: FG5 Front and Rear, Gas, 46MM, Bilstein (N/A 4-Wheel Drive) (N/A Z82 Trailering on Ext Cab Models) F51 Front and Rear, Heavy Duty (N/A Z71 Off-Road Chassis) (Incl w/Z82 Trailering or VYU Snow Plow Pkg) w/Z82 or VYU w/o Z82 or VYU
		NZZ SKID PLATE: Off-Road (K1500 Only) (Incls Front Differential and Transfer Case Shield) (Incl w/Z71 Off-Road Chassis) w/Z71 w/o Z71
		VYU SNOW PLOW PREP PACKAGE: (K1500 Only) (N/A Diesel Eng) (GU6 Axle w/o Z82 Trailering Reqs KC4 Eng Oil Cooler) (N/A CK10*53) (w/o Z71 Off-Road Package Incls F60 Front Springs and F51 Shock Absorbers) w/Z71 w/o Z71
		F60 SPRINGS: Front, Heavy Duty (K1500 Only) (N/A Diesel Eng or Z71 Off-Road Chassis) (Incl w/VYU Snow Plow Pkg) w/VYU w/o VYU
N/A		E24 THIRD DOOR: (Reqs C*10753, L30 or L31 Eng and M30 Trans) (N/A BG9 Floor Covering or ZY4 Paint or Vinyl Trim) (Door Lock Latch is Non-Electric)
		TIRES: Tubeless, Steel Belted Radial (Refer Tire Chart for Availability; Vehicle Price Schedule for Prices)
V76		TOW HOOKS: Two Front (Standard on K1500 Models) (N/A BYP Pkg on C1500 Model)
Z82		TRAILERING SPECIAL EQUIPMENT: Heavy-Duty (Incls Platform Trailer Hitch) (w/o Z71 or FG5 Incls F51 Shock Absorbers) (Incls KC4 Eng Oil Cooler w/o GT4 Axle or Diesel Eng) (C-K10903 or C-K10953 Reqs VB3 or V43 Bumper) (C10**3 w/L35 Eng Reqs GU6 Axle) (Reqs Automatic Trans) (K10**3 w/Z71 Off Road Pkg and L30 Eng Reqs GT4 Axle) (N/A Extended Cab w/FG5) With Diesel Engine w/Z71 or VYU w/o Z71 or VYU Without Diesel Engine w/VYU or Z71 w/o VYU or Z71
		NP1 TRANSFER CASE: Electronic Shift Control, 2-Speed (Reqs 4-Wheel Drive and Automatic Transmission) (Reqs ZQ3 Convenience Pkg or Silverado Decor)
		TRANSMISSIONS: (Refer Power Teams Chart for Availability)
MG5		5-Speed Manual with Overdrive, Light Duty
M50		5-Speed Manual with Overdrive, Light Duty
M30		4-Speed Electronically Controlled Automatic with Overdrive
MT1		4-Speed Electronically Controlled Automatic with Overdrive, Heavy-Duty
P06	x	WHEEL TRIM: Rally Wheel Trim w/1SB, 1SC or R9B w/1SA
		WHEELS: (Spare is Base Steel)
N90		Aluminum (C1500 Only) w/BYP w/1SB, 1SC or w/R9B w/1SA and w/o R9B
PF4		Aluminum (K1500 Only) w/BYP w/1SB, 1SC or R9B w/1SA and w/o R9B
N83		Chrome Wheel (C1500 Only) w/BYP w/1SB, 1SC or R9B w/1SA and w/o R9B
A28		WINDOWS: Sliding Rear (N/A C49 Defogger)

REVISED: 1-29-96

1996 ORDER GUIDE

C/K 1500 PICKUP

Page 15

Prices Shown Are Manufacturer's Suggested Retail Prices (MSRP) At The Time Of Publication. These Prices Are To Be Used Only As An Aid To Inventory Management Since MSRP Figures Change Periodically. The Vehicle Price Schedule Is The Official Pricing Documentation Of Chevrolet Motor Division And Should Be Used In Discussing Vehicle Prices With Potential Buyers. The Model Prices Shown In The Order Guide Include The Destination Freight Charges.

**C/K 1500 PICKUP
PAINT APPLICATIONS
WITH ZY1, ZY2 AND ZY4 PAINT SCHEMES
(ZY4 N/A w/E62 BODY CODE)**

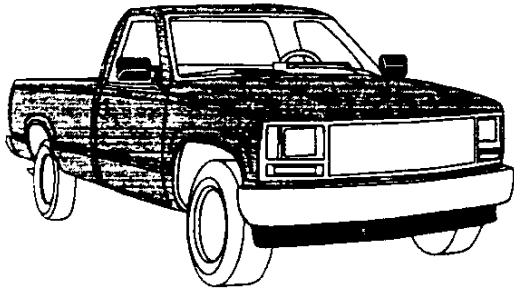

SOLID PAINT - ZY1 (w/E63 Fleetside)

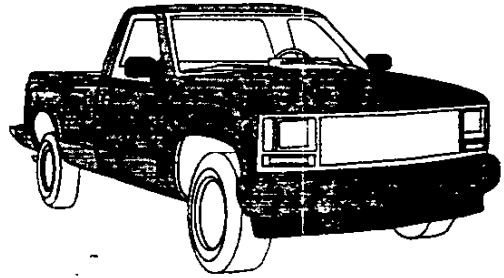

SOLID PAINT - ZY1 (w/E62 Sportside)

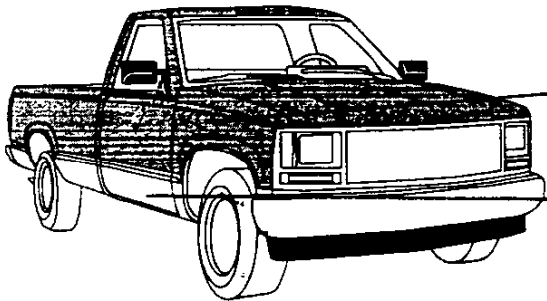

CONVENTIONAL TWO-TONE PAINT-ZY2 (w/E63 Fleetside)

COLOR CODE 1

COLOR CODE 2

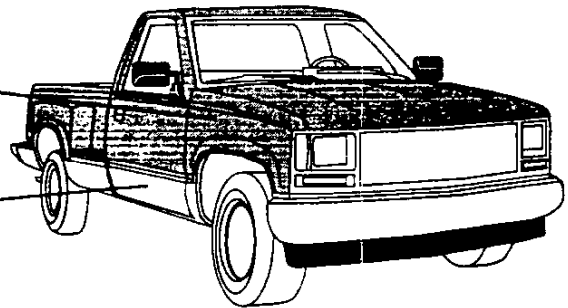

CONVENTIONAL TWO-TONE PAINT-ZY2 (w/E62 Sportside)

COLOR CODE 1

COLOR CODE 2

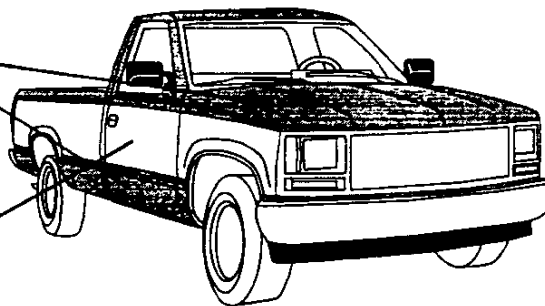

**DELUXE TWO-TONE PAINT - ZY4 (Reqs E63 Fleetside)
(Incls Decal Striping)**

C/K 1500 PICKUP INTERIOR AND EXTERIOR COLOR AVAILABILITY CHART WITH ZY1 PAINT SCHEMES

PLEASE NOTE: Below are the interior trim color and exterior paint combinations recommended by Chevrolet. They are the only available interior and exterior combinations allowed.

TRIM LEVEL (Must Specify Seat Option and Interior Color) Seat Type	SEAT OPT	INTERIOR COLORS				
		Neutral	Blue	Gray	Red	
CHEYENNE/X81 WORK TRUCK PKG (STD DECOR)						
REG CAB						
Vinyl Bench Seat	A52	52V	26V	13V	79V	
Cloth Bench Seat	A52	52C	26C	13C	79C	
EXTENDED CAB						
Vinyl Reclining Split Bench Seat	AE7	52V	26V	13V	79V	
Cloth Reclining Split Bench Seat	AE7	52C	26C	13C	79C	
SILVERADO DECOR						
REGULAR CAB						
Vinyl Bench Seat	A52	52V	26V	13V	79V	
Custom Cloth Bench Seat	A52	52D	26D	13D	79D	
* Custom Leather Bench Seat	A52	522	262	132	792	
Custom Cloth Reclining Split Bench Seat	AE7	52D	26D	13D	79D	
* Custom Leather Reclining Split Bench Seat	AE7	522	262	132	792	
Custom Cloth Reclining High Back Bkt Seats	A95	52D	26D	13D	79D	
EXTENDED CAB						
Vinyl Reclining Split Bench Seat	AE7	52V	26V	13V	79V	
Custom Cloth Reclining Split Bench Seat	AE7	52D	26D	13D	79D	
* Custom Leather Reclining Split Bench Seat	AE7	522	262	132	792	
Custom Cloth Reclining High Back Bkt Seats	A95	52D	26D	13D	79D	
* Custom Leather Reclining High Back Bkt Seats	A95	522	262	132	792	
EXTERIOR COLORS		Color Code	PAINT SCHEME	INTERIOR & EXTERIOR COMBINATIONS SHOWN ARE THE ONLY COMBINATIONS AVAILABLE		
AUTUMNWOOD, LT (Metallic)		55U	ZY1	x		
BLACK, ONYX		41U	ZY1	x		x
BLUE, INDIGO (Metallic)		39U	ZY1	x	x	
BLUE, LT (Metallic)		27U	ZY1		x	
GREEN, EMERALD (Metallic)		43U	ZY1	x		
GREEN, TEAL (Metallic)		38U	ZY1	x		
QUICKSILVER (Metallic)		96U	ZY1		x	x
RED, DK GARNET (Metallic)		84U	ZY1	x		x
RED, VICTORY		74U	ZY1	x		x
WHITE, SUMMIT		50U	ZY1	x	x	x

* Leather on Seating Surface Only

C/K 1500 PICKUP INTERIOR AND EXTERIOR COLOR AVAILABILITY CHART ZY2 PAINT SCHEMES

PLEASE NOTE: Below are the interior trim color and exterior paint combinations recommended by Chevrolet. They are the only available interior and exterior combinations allowed.

TRIM LEVEL (Must Specify Seat Option and Interior Color)		SEAT OPT	INTERIOR COLORS			
Seat Type			Neutral	Blue	Gray	Red
SILVERADO DECOR						
REGULAR CAB						
Vinyl Bench Seat		A52	52V	26V	13V	79V
Custom Cloth Bench Seat		A52	52D	26D	13D	79D
* Custom Leather Bench Seat		A52	522	262	132	792
Custom Cloth Reclining Split Bench Seat		AE7	52D	26D	13D	79D
* Custom Leather Reclining Split Bench Seat		AE7	522	262	132	792
Custom Cloth Reclining High Back Bkt Seats		A95	52D	26D	13D	79D
EXTENDED CAB						
Vinyl Reclining Split Bench Seat		AE7	52V	26V	13V	79V
Custom Cloth Reclining Split Bench Seat		AE7	52D	26D	13D	79D
* Custom Leather Reclining Split Bench Seat		AE7	522	262	132	792
Custom Cloth Reclining High Back Bkt Seats		A95	52D	26D	13D	79D
* Custom Leather Reclining High Back Bkt Seats		A95	522	262	132	792

EXTERIOR COLORS	Color Code 1	Color **Code 2	PAINT SCHEME	INTERIOR & EXTERIOR COMBINATIONS SHOWN ARE THE ONLY COMBINATIONS AVAILABLE			
Black, Onyx/Autumnwood, Lt (Met)	41U	55L	ZY2	x			
Black, Onyx/Quicksilver (Met)	41U	96L	ZY2			x	x
Blue, Indigo (Met)/Autumnwood, Lt (Met)	39U	55L	ZY2	x	x		
Blue, Indigo (Met)/Blue, Lt (Met)	39U	27L	ZY2		x	x	
Blue, Indigo (Met)/Quicksilver (Met)	39U	96L	ZY2		x	x	
Blue, Lt (Met)/Blue, Indigo (Met)	27U	39L	ZY2		x	x	
Blue, Lt (Met)/Quicksilver (Met)	27U	96L	ZY2		x	x	
Green, Emerald (Met)/Autumnwood, Lt (Met)	43U	55L	ZY2	x			
Green, Emerald (Met)/Quicksilver (Met)	43U	96L	ZY2			x	
Green, Teal (Met)/Autumnwood, Lt (Met)	38U	55L	ZY2	x			
Green, Teal (Met)/Quicksilver (Met)	38U	96L	ZY2			x	
Green, Teal (Met)/White	38U	50L	ZY2			x	
Quicksilver (Met)/Black, Onyx	96U	41L	ZY2			x	x
Quicksilver (Met)/Blue, Indigo (Met)	96U	39L	ZY2		x	x	
Quicksilver (Met)/Blue, Lt (Met)	96U	27L	ZY2		x	x	
Quicksilver (Met)/Red, Dk Garnet (Met)	96U	84L	ZY2			x	x
Red, Dk Garnet (Met)/Autumnwood, Lt (Met)	84U	55L	ZY2	x			x
Red, Dk Garnet (Met)/Quicksilver (Met)	84U	96L	ZY2			x	x
Red, Victory/Black, Onyx	74U	41L	ZY2	x		x	x
Red, Victory/Quicksilver (Met)	74U	96L	ZY2			x	x

* Leather on Seating Surface Only

** Color Code 2 Must be ordered as a (+) Plus option

**C/K 1500 PICKUP
INTERIOR AND EXTERIOR COLOR AVAILABILITY CHART
ZY4 PAINT SCHEMES
(ZY4 N/A w/E62 BODY CODE or X81 WORK TRUCK)**

PLEASE NOTE: Below are the interior trim color and exterior paint combinations recommended by Chevrolet. They are the only available interior and exterior combinations allowed.

TRIM LEVEL (Must Specify Seat Option and Interior Color) Seat Type	SEAT OPT	INTERIOR COLORS			
		Neutral	Blue	Gray	Red
SILVERADO DECOR					
REGULAR CAB					
Vinyl Bench Seat	A52	52V	26V	13V	79V
Custom Cloth Bench Seat	A52	52D	26D	13D	79D
* Custom Leather Bench Seat	A52	522	262	132	792
Custom Cloth Reclining Split Bench Seat	AE7	52D	26D	13D	79D
* Custom Leather Reclining Split Bench Seat	AE7	522	262	132	792
Custom Cloth Reclining High Back Bkt Seats	A95	52D	26D	13D	79D
EXTENDED CAB					
Vinyl Reclining Split Bench Seat	AE7	52V	26V	13V	79V
Custom Cloth Reclining Split Bench Seat	AE7	52D	26D	13D	79D
* Custom Leather Reclining Split Bench Seat	AE7	522	262	132	792
Custom Cloth Reclining High Back Bkt Seats	A95	52D	26D	13D	79D
* Custom Leather Reclining High Back Bkt Seats	A95	522	262	132	792

EXTERIOR COLORS	Color Code 1	Color Code 2	PAINT SCHEME	INTERIOR & EXTERIOR COMBINATIONS SHOWN ARE THE ONLY COMBINATIONS AVAILABLE				STRIPE COLORS Top-Lower/Center
Black, Onyx/Autumnwood, Lt (Met)	41U	55L	ZY4	x				Beige/Autumnwood
Black, Onyx/Quicksilver (Met)	41U	96L	ZY4			x	x	Gunmetal/Silver
Black, Onyx/Red, Victory (Met)	41U	74L	ZY4			x	x	Silver/Red
Black, Onyx/Red, Victory (Met)	41U	74L	ZY4	x				Gold/Black
Blue, Indigo (Met)/Blue, Lt (Met)	39U	27L	ZY4		x	x		Lt Indigo/Indigo
Blue, Indigo (Met)/Quicksilver (Met)	39U	96L	ZY4		x	x		Lt Indigo/Indigo
Blue, Indigo (Met)/White, Summit	39U	50L	ZY4		x	x		Lt Indigo/Indigo
Blue, Lt (Met)/Blue, Indigo (Met)	27U	39L	ZY4		x	x		Lt Indigo/Indigo
Blue, Lt (Met)/Quicksilver (Met)	27U	96L	ZY4		x	x		Lt Indigo/Indigo
Blue, Lt (Met)/White, Summit	27U	50L	ZY4		x	x		Lt Indigo/Indigo
Green, Emerald (Met)/Quicksilver (Met)	43U	96L	ZY4			x		Lt Emerald/Emerald
Green, Emerald (Met)/Autumnwood, Lt (Met)	43U	55L	ZY4	x				Lt Emerald/Emerald
Green, Teal (Met)/Quicksilver (Met)	38U	96L	ZY4			x		Teal/Silver
Green, Teal (Met)/White, Summit	38U	50L	ZY4			x		Teal/Silver
Quicksilver (Met)/Black, Onyx	96U	41L	ZY4			x	x	Gunmetal/Silver
Quicksilver (Met)/Blue, Indigo (Met)	96U	39L	ZY4		x	x		Lt Indigo/Indigo
Quicksilver (Met)/Blue, Lt (Met)	96U	27L	ZY4		x	x		Lt Indigo/Indigo
Quicksilver (Met)/Green, Teal (Met)	96U	38L	ZY4			x		Teal/Silver
Quicksilver (Met)/Red, Dk Garnet (Met)	96U	84L	ZY4			x	x	Gunmetal/Silver
Quicksilver (Met)/Red, Victory	96U	74L	ZY4			x	x	Gunmetal/Silver
Red, Dk Garnet (Met)/Autumnwood, Lt (Met)	84U	55L	ZY4	x				Beige/Autumnwood
Red, Dk Garnet (Met)/Quicksilver (Met)	84U	96L	ZY4			x	x	Gunmetal/Silver
Red, Dk Garnet (Met)/White, Summit	84U	50L	ZY4			x	x	Gunmetal/Silver
Red, Victory/Black, Onyx	74U	41L	ZY4				x	Gold/Black
Red, Victory/Black, Onyx	74U	41L	ZY4			x		Silver/Red
Red, Victory/Quicksilver (Met)	74U	96L	ZY4			x	x	Gunmetal/Silver
Red, Victory/White, Summit	74U	50L	ZY4	x				Gold/Black
Red, Victory/White, Summit	74U	50L	ZY4			x	x	Gunmetal/Silver

* Leather on Seating Surface Only

**C/K1500 SPORT TRUCK PICKUP
INTERIOR AND EXTERIOR COLOR AVAILABILITY CHART
WITH ZY1 PAINT**

PLEASE NOTE: Below are the interior trim color and exterior paint combinations recommended by Chevrolet. They are the only available interior and exterior combinations allowed.

TRIM LEVEL (Must Specify Seat Option and Interior Color) Seat Type		SEAT OPT	INTERIOR COLORS			
			Neutral	Blue	Gray	Red
Vinyl Bench Seat		A52	52V	26V	13V	79V
Custom Leather Bench Seat		A52	522	262	132	792
Custom Cloth Reclining Split Bench Seat		AE7	52D	26D	13D	79D
Custom Cloth Reclining High Back Bkt Seat		A95	52D	26D	13D	79D
EXTERIOR COLORS	Color Code	PAINT SCHEME	INTERIOR & EXTERIOR COMBINATIONS SHOWN ARE THE ONLY COMBINATIONS AVAILABLE			
			Neutral	Blue	Gray	Red
BLACK, ONYX	41U	ZY1	x		x	x
RED, VICTORY	74U	ZY1	x		x	x
WHITE, SUMMIT	50U	ZY1	x	x	x	x

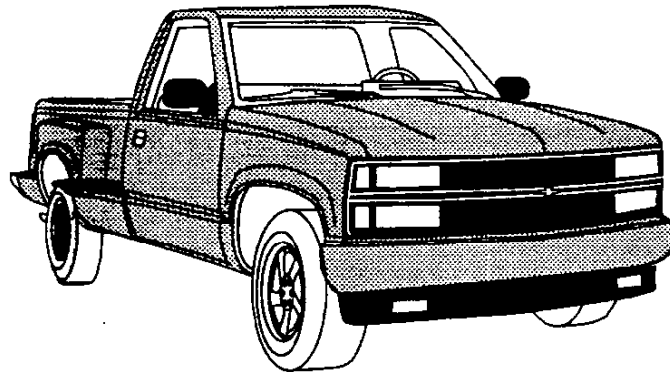

SOLID PAINT -- ZY1

2500 PICKUP EQUIPMENT SUMMARY

STANDARD INTERIOR FEATURES

		CHEYENNE	SILVERADO
AIR BAG:	DRIVER'S SIDE (UNDER 8600 GVWR)	S	S
CUPHOLDERS:	DUAL IN DASH	S	S
DOOR BEAMS:	SIDE IMPACT	S	S
GAGES:	TRIP ODOMETER, OIL PRESSURE, VOLTMETER AND TACHOMETER	S	S
GLASS:	SOLAR RAY TINTED, ALL WINDOWS	S	S
JACK:	WITH WHEEL WRENCH	S	S
INSULATION:	UNDER DASH & FLOOR COVERING	S	S
LIGHTING:	DOME W/LH & RH DOOR SWITCH <u>W/DELAYED ENTRY FEATURE</u> , READING ASHTRAY, GLOVE-BOX, UNDERHOOD & CARGO LAMPS	S	S
POWER POINTS:	DUAL COVERED	S	S
SCOTCHGARD:	ALL CLOTH AND CARPET SURFACES	S	S
<u>SEAT BELTS:</u>	<u>ADJUSTABLE HEIGHT, FRONT</u>	S	S
WARNING TONE:	KEY-IN-IGNITION BUZZER	S	S

STANDARD EXTERIOR FEATURES

		CHEYENNE	SILVERADO
AIR DAM:	DARK ARGENT (UNDER 8600 GVW)	S	S
<u>LAMPS:</u>	<u>DAYTIME RUNNING</u>	S	S
FLARES:	WHEEL OPENING (K2500 W/C6P ONLY)	S	S
SPARE TIRE:	FULL SIZE TIRE & WHEEL, W/WINCH TYPE CARRIER MOUNTED UNDER REAR FRAME	S	S
TAILGATE:	REMOVABLE	S	S
TOW HOOKS:	TWO FRONT ON 4X4 MODELS	S	S
WIPERS:	INTERMITTENT WINDSHIELD W/PULSE WASHERS	S	S
WIRE HARNESS:	7 WIRE TRAILERING	S	S
WINDOW:	REAR QUARTER SWING-OUT (EXT CAB ONLY)	S	S

STANDARD CHASSIS FEATURES

		CHEYENNE	SILVERADO
BATTERY:	HEAVY-DUTY 600 CCA	S	S
BRAKES:	POWER ASSISTED FRONT DISC, REAR DRUM 4-WHEEL ANTI-LOCK	S	S
<u>ENGINE:</u>	<u>VORTEC 5000 V8 SFI ON CC20903 & CC20753 VORTEC 5700 V8 SFI</u>	S	S
<u>EXHAUST SYSTEM:</u>	<u>STAINLESS STEEL</u>	S	S
FUEL TANK:	25 GAL W/SHORT BOX MODELS 34 GAL W/LONG BOX MODELS	S	S
GENERATOR:	100 AMP	S	S
<u>STORAGE BOX:</u>	<u>UNDERHOOD, COVERED</u>	S	S
SUSPENSION FRT:	INDEPENDENT COIL W/2WD INDEPENDENT TORSION BAR W/4X4	S	S
SUSPENSION RR:	MULTI-LEAF SPRINGS	S	S
TRANSMISSION:	5-SPEED MANUAL W/OVERDRIVE	S	S

BOLD, ITALICS AND UNDERLINED INDICATES NEW FOR '96

**2500 PICKUP
TRIM DEFINITION & OPTION SUMMARY**

INTERIOR TRIM		CHEYENNE	SILVERADO
AIR CONDITIONING:		O	S
ASSIST HANDLES:	PASSENGER	S	S
CONVENIENCE GP:	POWER WINDOW LOCKS	--	S
	POWER LOCKS	O	--
	TILT WHEEL AND CRUISE CONTROL	O	S
DOOR TRIM:	MOLDED PLASTIC W/ARMREST	S	--
	COLOR-KEYED CLOTH AND CARPET TRIMMED	--	S
FLOOR COVERING:	COLOR-KEYED CARPET	O	S
	COLOR-KEYED RUBBER	S	O
	RUBBER FLOOR MATS	O	S
HEADLINER:	COLOR-KEYED CLOTH	S	S
INSULATION:	ADDITIONAL SOUND-DEADENING	--	S
MAP POCKETS:	IN PASSENGER AND DRIVER'S DOOR	S	S
RADIO:	AM/FM STEREO W/SEEK-SCAN AND CLOCK	S	--
	AM/FM STEREO W/SEEK-SCAN, CLOCK AND CASSETTE TAPE	O	S
SEATING:	CLOTH BENCH	O	S
	VINYL BENCH (N/A EXT CAB)	S	O
	CLOTH 60/40 SPLIT BENCH (EXT CAB)	O	S
	VINYL 60/40 SPLIT BENCH (EXT CAB)	S	O
STEERING WHEEL:	SIMULATED LEATHER	S	--
	LEATHER WRAPPED	--	S
STORAGE TRAY:	FULL WIDTH BEHIND SEAT	--	S
SUNSHADES	CLOTH COVERED W/LH STORAGE STRAP, W/RH MIRROR	S	S

EXTERIOR TRIM		CHEYENNE	SILVERADO
BUMPER FRT:	CHROME	S	--
	CHROME W/BLACK RUB STRIP	O	S
BUMPER RR:	CHROME W/STEP PAD	O	S
GRILLE:	MOLDED, PAINTED ARGENT	S	--
	CHROME DELUXE	O	S
HEADLAMPS:	SINGLE RECTANGULAR HALOGEN	S	--
	DUAL COMPOSITE - HALOGEN	O	S
HORN:	SINGLE NOTE	S	--
	DUAL NOTE	O	S
MIRRORS:	BREAK-A-WAY OSRV, BLACK	S	--
	ELECTRIC, REMOTE CONTROL, BLACK	--	S
MOLDINGS:	BODY SIDE WITH BRIGHT TRIM AND BRIGHT WHEEL OPENING TRIM (C2500 OR K2500 W/O C6P)	O	S
NAMEPLATES:	CHEYENNE BADGE ON B-PILLAR	S	--
	SILVERADO BADGE ON B-PILLAR	--	S
PAINT:	SINGLE TONE	S	--
WHEELS:	SILVER PAINTED W/BLACK CENTER CAP	S	--
	RALLY WHEEL TRIM	O	S

BOLD, ITALICS AND UNDERLINED INDICATES NEW FOR '96

MODEL AND BODY

Description	Model No	Body	Wheel Base	Description	Model No	Body	Wheel Base
2-WHEEL-DRIVE MODEL				4-WHEEL-DRIVE MODEL			
Fleetside	CC20903	E63	131.5	Fleetside	CK20903	E63 & C6P	131.5
Fleetside	CC20903	E63 & C6P	131.5	Fleetside, Ext Cab ..	CK20753	E63 & C6P	141.5
Fleetside, Ext Cab ..	CC20753	E63	141.5	Fleetside, Ext Cab ..	CK20953	E63 & C6P	155.5
Fleetside, Ext Cab ..	CC20953	E63 & C6P	155.5				

*Includes Destination & Handling Charges

EMISSIONS (Must Specify One) (Refer Emission Requirements Section)

- FE9 Federal Emission Requirements
- YF5 California Emission Requirements
- NG1 New York/Massachusetts Emission Requirements
- NB8 California or New York/Massachusetts Emission Override (Reqs FE9 Federal Emissions)
- NC7 Federal Emission Override (Reqs YF5 California or NG1 New York/Massachusetts Emissions)

GVWR SELECTOR (Must Specify GVW Option)

Minimum Equipment Required for GVW Rating

GVW Option Required	GVW Rating (lbs)	GAWR*		
		Front	Rear	
C20903				
C5Z	7200	3150	4670	Reqs L30 or L31 Eng
C5Z	7200	3400	4670	Reqs L56 Eng
C6P	8600	3600	6000	Reqs C6P & YHH or YGK
K20903				
C6P	8600	4250	6000	Reqs C6P & YHH or YGK
C20753				
C5Z	7200	3925	4410	N/A L65 Eng
C20953				
C6P	8600	3600	6000	Reqs C6P & YHH or YGK
CK20753/K20953				
C6P	8600	4250	6000	Reqs C6P & YHH or YGK

*GAWR's shown are the minimum for each axle with equipment listed. Other GAWR's are available, and they are determined as the minimum capacity of either axle, springs or tires.

C/K2500 PICKUP

POWER TEAMS (Must Specify Engine, Transmission and Rear Axle)

(Consult GVWR Selector For Minimum Equipment Required)

ENGINE	TRANSMISSION		AXLE			GVWR
	5-SP	AUTO	3.42	3.73	4.10	
	Lt Duty / H Duty	Lt Duty / H Duty				
CC20903						
L30 Vortec 5000 V8 (305 Cu In)-SFI	MG5		(a) GU6	(a) GT4	--	7200
L31 Vortec 5700 V8 (350 Cu In)-SFI		M30	GU6	GT4	--	7200
L31 Vortec 5700 V8 H. D. (350 Cu In)-SFI	M50	M30	GU6	GT4	--	7200
L31 Vortec 5700 V8 H. D. (350 Cu In)-SFI	MW3		--	(a) GT4	(a) GT5	8600
L29 Vortec 7400 V8 H. D. (454 Cu In)-SFI	MW3	MT1	--	GT4	GT5	8600
L29 Vortec 7400 V8 H. D. (454 Cu In)-SFI		MT1	--	(a) GT4	(a) GT5	8600
L56 Turbo Diesel 6.5 Liter V8 (400 Cu In)		MT1	--	GT4	GT5	8600
L56 Turbo Diesel 6.5 Liter V8 (400 Cu In)		MT1	(a) GU6	(a) GT4	--	7200
L65 Turbo Diesel 6.5 Liter V8 H. D. (400 Cu In)	MW3	MT1	--	GT4	GT5	8600
CK20903						
L31 Vortec 5700 V8 H. D. (350 Cu In)-SFI	MW3		--	(a) GT4	(a) GT5	8600
L29 Vortec 7400 V8 H. D. (454 Cu In)-SFI		MT1	--	--	GT5	8600
L29 Vortec 7400 V8 H. D. (454 Cu In)-SFI	MW3		--	(a) GT4	(a) GT5	8600
L29 Vortec 7400 V8 H. D. (454 Cu In)-SFI		MT1	--	GT4	GT5	8600
L65 Turbo Diesel 6.5 Liter V8 H. D. (400 Cu In)	MW3	MT1	--	GT4	GT5	8600

(a) N/A YF5 California Emissions

CONTINUED ON PAGE 5

POWER TEAMS (Continued)

(Consult GVWR Selector For Minimum Equipment Required)

ENGINE	TRANSMISSION		AXLE			GVWR
	5-SP Lt Duty / H Duty	AUTO Lt Duty / H Duty	3.42	3.73	4.10	
CC20753						
L30 Vortec 5000 V8 (305 Cu In)-SFI	MG5		(a) GU6	--	--	7200
		M30	GU6	GT4	--	7200
L31 Vortec 5700 V8 (350 Cu In)-SFI	M50	M30	GU6	GT4	--	7200
L56 Turbo Diesel V8 6.5 Liter (400 Cu In)		MT1	(a) GU6	(a) GT4	--	7200
CC20953						
L31 Vortec 5700 V8 H.D. (350 Cu In)-SFI	MW3		--	(a) GT4	(a) GT5	8600
		MT1	--	GT4	GT5	8600
L29 Vortec 7400 V8 H. D. (454 Cu In)-SFI	MW3		--	(a) GT4	(a) GT5	8600
		MT1	--	GT4	GT5	8600
L65 Turbo Diesel H.D. 6.5 Liter V8 (400 Cu In)	MW3	MT1		GT4	GT5	8600
CK20753/CK20953						
L31 Vortec 5700 V8 H.D. (350 Cu In)-SFI	MW3		--	(a) GT4	(a) GT5	8600
		MT1	--	--	GT5	8600
(b) L29 Vortec 7400 V8 H. D. (454 Cu In)-SFI	MW3		--	(a) GT4	(a) GT5	8600
		MT1	--	GT4	GT5	8600
L65 Turbo Diesel H.D. 6.5 Liter V8 (400 Cu In)	MW3	MT1	--	GT4	GT5	8600

(a) N/A YF5 California Emissions
(b) N/A k20753

CAPACITIES

C20903	
SPRINGS:	AXLES:
Front	Front
3150 Base	3150 Base
3400 w/Diesel Eng	3400 w/Diesel Eng
3600 w/C6P	3800 w/C6P
Rear	Rear
4800 Base	4800 Base
6084 w/C6P	6000 w/C6P

K20903	
SPRINGS	AXLES
Front	Front
4250 w/C6P	4250 w/C6P
Rear	Rear
4800 Base	4800 Base
6084 w/C6P	6000 w/C6P

C20753-C20953	
SPRINGS:	AXLES:
Front	Front
3600 Base	3600 Base
	3800 w/C6P
Rear	Rear
4800 Base	4800 Base
6084 w/C6P	6000 w/C6P

K20953	
SPRINGS:	AXLES:
Front	Front
3925 Base	3925 Base
4250 w/C6P	4250 w/C6P
Rear	Rear
4800 Base	4800 Base
6084 w/C6P	6000 w/C6P

TIRES: (Must Specify Front and Rear) (Spare Tire and Tire Carrier Included) (Spare Matches Rear Tire)

Description	All Season		On-Off Road	
	Front	Rear	Front	Rear
C20903				
TUBELESS Steel Belted Radial				
(a) LT225/75R16-D B/W	XHP	YHP		
(a) LT225/75R16-D B/W	XHP			YHR
LT245/75R16-E B/W	XHH	YHH		
LT245/75R16-E B/W	XHH			YGK
K20903				
TUBELESS Steel Belted Radial				
LT245/75R16-E B/W			XGK	YGK
LT245/75R16-E B/W	XHH	YHH		
C20753				
TUBELESS Steel Belted Radial				
LT225/75R16-D B/W	XHP	YHP		
LT225/75R16-D B/W	XHP			YHR
LT245/75R16-E B/W	XHH	YHH		
LT245/75R16-E B/W	XHH			YGK
C20953				
TUBELESS Steel Belted Radial				
LT245/75R16-E B/W	XHH	YHH		
LT245/75R16-E B/W	XHH			YGK
K20953				
TUBELESS Steel Belted Radial				
LT245/75R16-E B/W			XGK	YGK
LT245/75R16-E B/W	XHH	YHH		

(a) N/A C6P 8600 GVWR

WOL = White Outlined Letter
B/W = Blackwall

REVISED: 1-29-96

1996 ORDER GUIDE

C/K 2500 PICKUP

Page 7

Prices Shown Are Manufacturer's Suggested Retail Prices (MSRP) At The Time Of Publication. These Prices Are To Be Used Only As An Aid To Inventory Management Since MSRP Figures Change Periodically. The Vehicle Price Schedule Is The Official Pricing Documentation Of Chevrolet Motor Division And Should Be Used In Discussing Vehicle Prices With Potential Buyers. The Model Prices Shown In The Order Guide include The Destination Freight Charges.

MUST SPECIFY:

AXLE, EMISSION, ENGINE, TIRES AND TRANSMISSION

No Deletions Allowed. Additional Options/Upgrades (Where Indicated) May be Ordered from the Custom Ordering Options Listing.

Reg & Ext Decor

	Reg & Ext Decor		
	CHEYENNE	SILVERADO	
	1 S A	1 S B	1 S C
CHEYENNE DECOR	X	--	--
Fleetside Body Code E63	X	X	X
SILVERADO DECOR YE9		X	X
Air Conditioning		X	X
Radio: AM/FM Stereo w/Cassette (A)		X	X
Tilt and Cruise		X	X
SILVERADO DECOR (Leather)			
Regular Cab:			
Extended Cab:			
Keyless Entry AUO			X
Mirror, 10" Electrochromic ISRV w/8 Point Compass DD7			X
Seat, Power (B) AG9			X
Trim, Leather (C) AE7			X

- (A) May upgrade
- (B) Extended Cab Only
- (C) Must Specify Trim Color. May Upgrade to A95 Seat on Extended Cab

Preferred Equipment Group Prices

Preferred Equipment Group Prices

- 1SA
- PEG Savings
- w/R9A, R9B & R9C
- w/R9A, R9B or R9C
- w/R9A
- w/R9B & R9C
- w/R9B or R9C
- w/o R9A, R9B or R9C

**PEG Savings Amount represents the savings for Preferred Equipment Groups.

REGULAR CAB MARKETING PACKAGES

CONVENIENCE PACKAGE

ORDERING OPTION=R9A

(Reqs Peg 1SA)

Incls :

- C60 Air Conditioning
- UM6 Radio w/Cassette
- ZQ3 Tilt and Cruise

BRIGHT APPEARANCE PACKAGE

ORDERING OPTION=R9B

(Reqs Peg 1SA)

Incls :

- B85 Body Side Moldings
- V22 Chrome Grille
- VB3 Chrome Rear Step Bumper
- VG3 Chromed Front Bumper
- P06 Wheel Trim

COMMERCIAL OPTION PACKAGE

ORDERING OPTION=R9C

(Reqs Peg 1SA) (N/A R9B Bright Appearance Pkg)

Incls :

- BZY Bedliner
- E63 Fleetside
- V43 Painted Step Bumper w/o R9B
- F60 HD Front Springs (K Models Only)
- V76 Tow Hooks (C Models Only)
- NZZ Skid Plate (K Models Only)
- A28 Sliding Rear Window

EXTENDED CAB MARKETING PACKAGES

CONVENIENCE PACKAGE \$1,335.00

ORDERING OPTION=R9A

(Reqs Peg 1SA)

Incls :

- C60 Air Conditioning
- UM6 Radio w/Cassette
- ZQ3 Tilt and Cruise

BRIGHT APPEARANCE PACKAGE

ORDERING OPTION=R9B

(Reqs Peg 1SA)

Incls :

- B85 Body Side Moldings
- V22 Chrome Grille
- VB3 Chrome Rear Step Bumper
- VG3 Chromed Front Bumper
- P06 Rally Wheels

COMMERCIAL OPTION PACKAGE

ORDERING OPTION=R9C

(Reqs Peg 1SA) (N/A R9B Bright Appearance Pkg)

Incls :

- BZY Bedliner
- E63 Fleetside
- V43 Painted Step Bumper w/o R9B
- F60 HD Front Springs (K Models Only)
- V76 Tow Hooks (C Models Only)
- NZZ Skid Plate (K Models Only)
- A28 Sliding Rear Window

ADDITIONAL OPTIONS

INCL W/DECOR		OPTION
CHEY- ENNE	SILVER- ADO	
N/A		ACKNOWLEDGEMENTS: R8S Multiple Order Numbers R8T Preliminary Invoice (Refer Vehicle Price Schedule for Prices) K47 AIR CLEANER: High Capacity (N/A Diesel Eng) C60 AIR CONDITIONING: (Incls R134A Refrigerant) w/1SB, 1SC or R9A w/1SA V22 APPEARANCE PACKAGE: (Incls Chrome Grille, Composite Halogen Headlamps and Dual Horns) w/1SB, 1SC or R9B w/1SA AXLES, REAR: (Refer Power Teams Chart for Availability) GU6 3.42 Ratio (Incls Eng Oil Cooler w/Diesel Eng) GT4 3.73 Ratio (Incls Eng Oil Cooler) GT5 4.10 Ratio (Incls Eng Oil Cooler) w/o L31 and MW3 or MT1 w/L31 and MW3 or MT1 G80 Locking Differential (N/A GU6 Axle) TP2 BATTERY: Heavy-Duty, Auxiliary (Reqs L29, L30, or L31 Eng) (Deletes Underhood Storage Box) BZY BEDLINER: Under Rail w/R9C w/o R9C E63 BODY: Fleetside BUMPER EQUIPMENT: EF1 Bumper Delete Provisions: (Reqs E62 or E63 Body) VB3 Bumper, Chromed, Rear Step w/Rub Strip (Reqs VG3 Bumper or Silverrader Decor) w/1SB, 1SC or R9B w/o 1SB, 1SC or R9B VG3 Bumper, Chromed, Front Deluxe w/Rub Strip w/1SB, 1SC or R9B w/o 1SB, 1SC or R9B N/A V43 Bumper, Painted, Rear Step w/R9C w/o R9C V10 COLD-CLIMATE PACKAGE: (Incls Eng Block Heater) ZQ3 CONVENIENCE GROUP: Tilt-Wheel and Speed Control w/1SB, 1SC or R9A w/o 1SB, 1SC or R9A COOLING SYSTEM: (Engine Oil Cooler comparable to KC4 is standard w/o GU6 Axle) (Incl w/Z82 Trailering Where Available) (Diesel Eng Reqs Base Decor and Reg Cab) KC4 Engine Oil (N/A Diesel Eng, GT4 Axle or C6P GVW) w/Z82 w/o Z82 KNP Transmission, Heavy-Duty Auxiliary (Reqs L31 Eng & M30 Trans) (Incl w/MT1 Trans or w/Z82 Trailering when L31 Eng and M30 Trans are ordered) w/MT1 or w/Z82 & Auto Trans w/o MT1 or w/o Z82 & Auto Trans N/A C49 DEFOGGER: Electric Rear Window (N/A A28 Window or C-K20903) EMISSIONS: (Refer Emission Requirement Tab Section) FE9 Federal Emission Requirements YF5 California Emission Requirements w/L31 and M30 w/o L31 and M30 NG1 New York/Massachusetts Emission Requirements NB8 California or New York/Massachusetts Emission Override (Reqs FE9 Federal Emissions) NC7 Federal Emission Override (Reqs YF5 California or NG1 New York/Massachusetts Emissions) ENGINES: (Refer Power Teams Chart for Availability) L30 Vortec 5000 V8 (305 Cu In)--SF1 L31 Vortec 5700 V8 (350 Cu In)--SF1 w/C6P w/o C6P L56 6.5 Liter V8 Turbo Diesel (400 Cu In) (Deletes Underhood Storage Box) L65 6.5 Liter V8 Turbo Diesel (400 Cu In) KL5 Alternative Fuel (LPG and CNG Conversion Ready) (Reqs L31 Eng, C6P GVW and Auto Trans) (N/A C/K20753)

ADDITIONAL OPTIONS

INCL W/DECOR		OPTION
CHEV- ENNE	SILVER- ADO	
N/A		FLOOR COVERING:
		BG9 Full Floor, Rubber, Color-Keyed (Replaces Carpeting and Floor Mats) (N/A BYP Sport Pkg) w/C-K10*03 w/C-K10*53
	N/A	B30 Carpet Floor Covering w/C-K10*03 w/C-K10*53
	N/A	B32 Floor Mats (Reqs B30 Floor Covering)
	N/A	B33 Floor Mats (N/A YG4 Seat Delete) (Reqs B30 Carpet, B32 Floor Mats and C-K***53)
		AJ1 GLASS: Deep Tinted Solar-Ray (When A28 Window or C49 Defogger is Specified Rear Window is Light Tint Glass) (N/A C-K20903) w/A28 or C49 w/o A28 or C49
		GVWR: (Must Specify One) (Refer GVWR Selector Chart for Availability)
		C5Z 7200#
		C6P 8600#
N/A		AU0 KEYLESS ENTRY: Remote w/1SC w/o 1SC
		U01 LAMPS: Roof Marker (N/A YF5 Calif Emissions)
		VK3 LICENSE PLATE BRACKET: Front
	N/A	AU3 LOCKS: Power Door w/1SB or 1SC w/o 1SB or 1SC
		MIRRORS:
		DF2 Camper Type, Stainless Steel, 7.5" W x 10.5" H, Exterior w/1SB or 1SC w/1SA
N/A		DD7 10" Electrochromic ISRV with 8 Point Compass, Interior
	x	B85 MOLDING: Exterior, Bright (Incls Body Side and Wheel Opening) (K2500 w/C6P Incls Body Side Mldg Only) w/1SB, 1SC or R9B K2500 w/C6P K2500 w/o C6P or C2500
		PAINT, EXTERIOR: (Refer Color and Trim Chart for Availability)
		ZY1 Solid
N/A		ZY2 Conventional Two-Tone
N/A		ZY4 Deluxe Two-Tone
		RADIO EQUIPMENT:
	x	UM6 Electronically Tuned AM/FM Stereo Radio w/Seek-Scan, Stereo Cassette Tape and Digital Clock w/1SB, 1SC or R9A w/1SA w/o R9A
N/A		UL0 Electronically Tuned AM/FM Stereo Radio w/Seek-Scan w/Automatic Tone Control, Digital Clock Cassette Tape, Theft Lock and Speed Compensated Volume (Incls Enhanced Performance Speaker System)
N/A		UN0 Electronically Tuned AM/FM Stereo Radio w/Seek-Scan w/Automatic Tone Control, Compact Disc Player, Digital Clock, Theft Lock and Speed Compensated Volume (w/Silverado Decor Incls an Enhanced Performance Speaker System)
N/A		UP0 Electronically Tuned AM/FM Stereo Radio w/Seek-Scan w/Automatic Tone Control, Compact Disc Player, Digital Clock, Cassette Tape, Theft Lock and Speed Compensated Volume (Incls Enhanced Performance Speaker System) (Reqs M30 or MT1 Trans)
	N/A	UL5 Radio Delete
N/A		AG9 SEAT: Power Driver's Seat (N/A Vinyl Trim or A52 Bench Seat) (N/A C-K 20903) w/1SC w/o 1SC
	N/A	YG4 SEAT DELETE: Rear (N/A C-K20903)
		SEAT TYPE: (Refer Color/Trim Chart for Availability)
		A52 Bench Seat (Incls Storage Armrest and Power Lumbar w/Custom Cloth or Leather Trim) w/1SA or 1SB w/o Leather w/1SB with Leather
		AE7 Reclining 60/40 Split Bench Seat (Incls Storage Armrest and Power Lumbar w/Custom Cloth or Leather Trim) w/1SC
		Extended Cab w/1SA or 1SB w/o Leather w/1SB and Leather
		Regular Cab w/1SA or 1SB w/o Leather w/1SB and Leather
		A95 Reclining High Back Bucket Seats (Incls Power Lumbar)
		Extended Cab w/1SB w/o Leather or 1SC w/1SB and Leather
		Regular Cab w/1SC and Leather w/1SB w/o Leather w/1SB and Leather

ADDITIONAL OPTIONS

INCL W/DECOR	
CHEY- ENNE	SILVER- ADO

- | OPTION | |
|--------|--|
| NZZ | SKID PLATE: Off-Road (K2500 Only) (Incls Front Differential and Transfer Case Shield)
w/R9C
w/o R9C |
| VYU | SNOW PLOW PREP PACKAGE: (K20903 Only) (N/A L56 Eng) (GU6 Axle w/o Z82 Trailering
Reqs KC4 Cooling) (Incls F60 H D Front Springs) |
| F60 | SPRINGS, FRONT: Heavy Duty (K2500 Only) (N/A L56 Engine) (Incl w/VYU Snow Plow)
w/APR or VYU
w/o APR |
| V76 | TIRES: (Refer Tire Chart for Availability; Vehicle Price Schedule for Prices)
TOW HOOKS: Two Front (Standard on K2500 Models)
w/R9C
w/o R9C |
| Z82 | TRAILERING SPECIAL EQUIPMENT: Heavy-Duty (Incls Trailer Hitch)
(w/C-K209*3 w/o Silverado Decor Reqs V63 or V43 Bumper) (w/GU6 Axle Incls KC4 Cooling w/o Diesel Eng)
(N/A MG5 or M50 Trans)
w/Diesel or GT5
w/MW3
w/Auto |
| NP1 | TRANSFER CASE: Electronic Shift Control, 2-Speed (Reqs 4-Wheel Drive and Automatic Transmission)
(Reqs ZQ3 Convenience Pkg or Silverado Decor) |
| | TRANSMISSIONS: (Refer Power Teams Chart for Availability) |
| MG5 | 5-Speed Manual with Overdrive, L.D. |
| M50 | 5-Speed Manual with Overdrive |
| MW3 | 5-Speed Manual with Deep Low and Overdrive, Heavy-Duty
w/C6P or Diesel Eng
w/o C6P or Diesel Eng |
| M30 | 4-Speed Electronically Controlled Automatic with Overdrive |
| MT1 | 4-Speed Electronically Controlled Automatic with Overdrive, Heavy-Duty |
| PC6 | WHEEL TRIM: Rally Wheel Trim
w/1SB, 1SC or R9B
w/1SA |
| A28 | WINDOWS: Sliding Rear (N/A C49 Defogger) |

**C/K 2500 PICKUP
PAINT APPLICATIONS
WITH ZY1, ZY2 AND ZY4 PAINT SCHEMES**

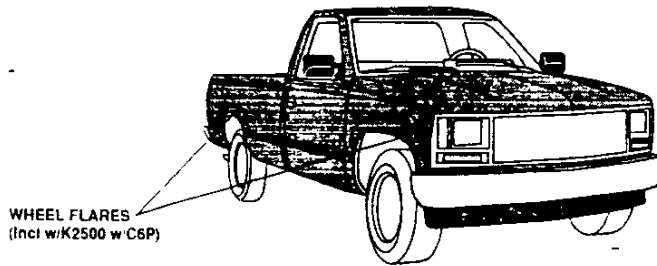

SOLID PAINT - ZY1

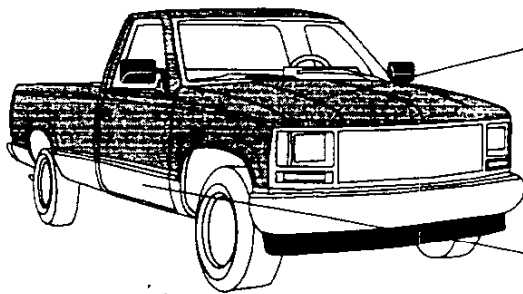

CONVENTIONAL TWO-TONE PAINT - ZY2

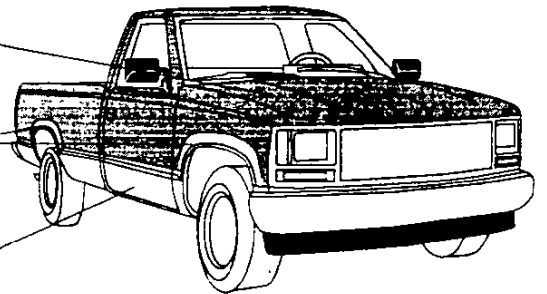

**CONVENTIONAL TWO-TONE PAINT - ZY2
K2500 w/C6P**

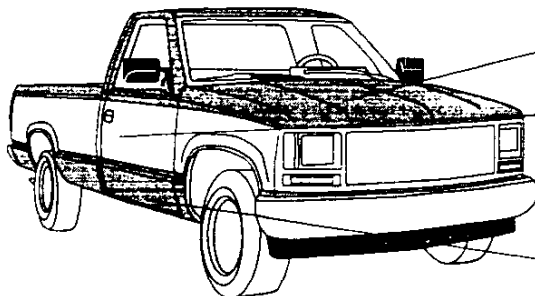

**DELUXE TWO-TONE PAINT - ZY4
(Includes Body Striping)**

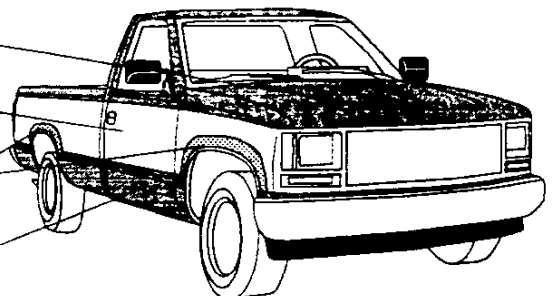

**DELUXE TWO-TONE PAINT - ZY4
(Includes Body Striping)
K2500 w/C6P**

C/K 2500 PICKUP INTERIOR AND EXTERIOR COLOR AVAILABILITY CHART WITH ZY1 PAINT SCHEMES

PLEASE NOTE: Below are the interior trim color and exterior paint combinations recommended by Chevrolet. They are the only available interior and exterior combinations allowed.

TRIM LEVEL (Must Specify Seat Option and Interior Color) Seat Type	SEAT OPT	INTERIOR COLORS			
		Neutral	Blue	Gray	Red
CHEYENNE/X81 WORK TRUCK PKG (STD.DECOR)					
REG CAB					
Vinyl Bench Seat	A52	52V	26V	13V	79V
Cloth Bench Seat	A52	52C	26C	13C	79C
EXTENDED CAB					
Vinyl Reclining Split Bench Seat	AE7	52V	26V	13V	79V
Cloth Reclining Split Bench Seat	AE7	52C	26C	13C	79C
SILVERADO DECOR					
REGULAR CAB					
Vinyl Bench Seat	A52	52V	26V	13V	79V
Custom Cloth Bench Seat	A52	52D	26D	13D	79D
* Custom Leather Bench Seat	A52	522	262	132	792
Custom Cloth Reclining Split Bench Seat	AE7	52D	26D	13D	79D
* Custom Leather Reclining Split Bench Seat	AE7	522	262	132	792
Custom Cloth Reclining High Back Bkt Seats	A95	52D	26D	13D	79D
EXTENDED CAB					
Vinyl Reclining Split Bench Seat	AE7	52V	26V	13V	79V
Custom Cloth Reclining Split Bench Seat	AE7	52D	26D	13D	79D
* Custom Leather Reclining Split Bench Seat	AE7	522	262	132	792
Custom Cloth Reclining High Back Bkt Seats	A95	52D	26D	13D	79D
* Custom Leather Reclining High Back Bkt Seats	A95	522	262	132	792

EXTERIOR COLORS	Color Code	PAINT SCHEME	INTERIOR & EXTERIOR COMBINATIONS SHOWN ARE THE ONLY COMBINATIONS AVAILABLE				K2500 w/C6P Wheel Flare Color
			Neutral	Blue	Gray	Red	
AUTUMNWOOD, LT (Metallic)	55U	ZY1	x				Autumnwood, Lt
BLACK, ONYX	41U	ZY1	x		x	x	Black
BLUE, INDIGO (Metallic)	39U	ZY1	x	x	x		Indigo
BLUE, LT (Metallic)	27U	ZY1		x	x		Dk Argent
GREEN, EMERALD (Metallic)	43U	ZY1	x		x		Dk Argent
GREEN, TEAL (Metallic)	38U	ZY1	x		x		Dk Argent
QUICKSILVER (Metallic)	96U	ZY1		x	x	x	Silver
RED, Dk GARNET (Metallic)	84U	ZY1	x		x	x	Red, Dk Garnet
RED, VICTORY	74U	ZY1	x		x	x	Dk Argent
WHITE, SUMMIT	50U	ZY1	x	x	x	x	Dk Argent

* Leather on Seating Surface Only

C/K 2500 PICKUP INTERIOR AND EXTERIOR COLOR AVAILABILITY CHART ZY2 PAINT SCHEMES

PLEASE NOTE: Below are the interior trim color and exterior paint combinations recommended by Chevrolet. They are the only available interior and exterior combinations allowed.

TRIM LEVEL (Must Specify Seat Option and Interior Color) Seat Type	SEAT OPT	INTERIOR COLORS			
		Neutral	Blue	Gray	Red
SILVERADO DECOR					
REGULAR CAB					
Vinyl Bench Seat	A52	52V	25V	13V	79V
Custom Cloth Bench Seat	A52	52D	26D	13D	79D
*** Custom Leather Bench Seat	A52	522	262	132	792
Custom Cloth Reclining Split Bench Seat	AE7	52D	26D	13D	79D
*** Custom Leather Reclining Split Bench Seat	AE7	522	262	132	792
Custom Cloth Reclining High Back Bkt Seats	A95	52D	26D	13D	79D
EXTENDED CAB					
Vinyl Reclining Split Bench Seat	AE7	52V	26V	13V	79V
Custom Cloth Reclining Split Bench Seat	AE7	52D	26D	13D	79D
*** Custom Leather Reclining Split Bench Seat	AE7	522	262	132	792
Custom Cloth Reclining High Back Bkt Seats	A95	52D	26D	13D	79D
*** Custom Leather Reclining High Back Bkt Seats	A95	522	262	132	792

EXTERIOR COLORS	Color Code 1	Color Code 2	PAINT SCHEME	INTERIOR & EXTERIOR COMBINATIONS SHOWN ARE THE ONLY COMBINATIONS AVAILABLE				K2500 w/C6P WHEEL FLARE
Black, Onyx/Autumnwood, Lt (Met)	41U	55L	ZY2	x				Autumnwood
Black, Onyx/Quicksilver (Met)	41U	96L	ZY2			x	x	Silver
Blue, Indigo (Met)/Autumnwood, Lt (Met)	39U	55L	ZY2	x	x			Autumnwood
* Blue, Indigo (Met)/Blue, Lt (Met)	39U	27L	ZY2		x	x		N/A
Blue, Indigo (Met)/Quicksilver (Met)	39U	96L	ZY2		x	x		Silver
Blue, Lt (Met)/Blue, Indigo (Met)	27U	39L	ZY2		x	x		Indigo
Blue, Lt (Met)/Quicksilver (Met)	27U	96L	ZY2		x	x		Silver
Green, Emerald (Met)/Autumnwood, Lt (Met)	43U	55L	ZY2	x				Autumnwood
Green, Emerald (Met)/Quicksilver (Met)	43U	96L	ZY2			x		Silver
Green, Teal (Met)/Autumnwood, Lt (Met)	38U	55L	ZY2	x				Autumnwood
Green, Teal (Met)/Quicksilver (Met)	38U	96L	ZY2			x		Silver
* Green, Teal (Met)/White	38U	50L	ZY2			x		N/A
Quicksilver (Met)/Black, Onyx	96U	41L	ZY2			x	x	Black
Quicksilver (Met)/Blue, Indigo (Met)	96U	39L	ZY2		x	x		Indigo
* Quicksilver (Met)/Blue, Lt (Met)	96U	27L	ZY2		x	x		N/A
Quicksilver (Met)/Red, Dk Garnet (Met)	96U	84L	ZY2			x	x	Dk Red
Red, Dk Garnet (Met)/Autumnwood, Lt (Met)	84U	55L	ZY2	x				Autumnwood
Red, Dk Garnet (Met)/Quicksilver (Met)	84U	96L	ZY2			x	x	Silver
Red, Victory/Black, Onyx	74U	41L	ZY2	x		x	x	Black
Red, Victory/Quicksilver (Met)	74U	96L	ZY2			x	x	Silver

- * N/A C6P on K2500
- ** Color Code 2 Must be ordered as a (+) Plus option
- *** Leather on Seating Surface Only

**C/K 2500 PICKUP
INTERIOR AND EXTERIOR COLOR AVAILABILITY CHART
ZY4 PAINT SCHEMES**

PLEASE NOTE: Below are the interior trim color and exterior paint combinations recommended by Chevrolet. They are the only available interior and exterior combinations allowed.

TRIM LEVEL (Must Specify Seat Option and Interior Color) Seat Type	SEAT OPT	INTERIOR COLORS			
		Neutral	Blue	Gray	Red
SILVERADO DECOR					
REGULAR CAB					
Onyx Bench Seat	A52	52V	26V	13V	79V
Custom Cloth Bench Seat	A52	52D	26D	13D	79D
*** Custom Leather Bench Seat	A52	522	262	132	792
Custom Cloth Reclining Split Bench Seat	AE7	52D	26D	13D	79D
*** Custom Leather Reclining Split Bench Seat	AE7	522	262	132	792
Custom Cloth Reclining High Back Bkt Seats	A95	52D	26D	13D	79D
EXTENDED CAB					
Onyx Reclining Split Bench Seat	AE7	52V	26V	13V	79V
Custom Cloth Reclining Split Bench Seat	AE7	52D	26D	13D	79D
*** Custom Leather Reclining Split Bench Seat	AE7	522	262	132	792
Custom Cloth Reclining High Back Bkt Seats	A95	52D	26D	13D	79D
*** Custom Leather Reclining High Back Bkt Seats	A95	522	262	132	792

EXTERIOR COLORS	Color Code 1	** Color Code 2	PAINT SCHEME	INTERIOR & EXTERIOR COMBINATIONS SHOWN ARE THE ONLY COMBINATIONS AVAILABLE				STRIPE COLORS Top-Lower/Camber	K2500 w/C6P WHEEL FLARE COLOR
Black, Onyx/Autumnwood, Lt (Met)	41U	55L	ZY4	x				Beige/Autumnwood	Black
Black, Onyx/Quicksilver (Met)	41U	96L	ZY4			x	x	Gunmetal/Silver	Black
Black, Onyx/Red, Victory (Met)	41U	74L	ZY4			x	x	Silver/Red	Black
Black, Onyx/Red, Victory (Met)	41U	74L	ZY4	x				Gold/Black	Black
Blue, Indigo (Met)/Blue, Lt (Met)	39U	27L	ZY4		x	x		Lt Indigo/Indigo	Blue
Blue, Indigo (Met)/Quicksilver (Met)	39U	96L	ZY4		x	x		Lt Indigo/Indigo	Blue
Blue, Indigo (Met)/White, Summit	39U	50L	ZY4		x	x		Lt Indigo/Indigo	Blue
* Blue, Lt (Met)/Blue, Indigo (Met)	27U	39L	ZY4		x	x		Lt Indigo/Indigo	N/A
* Blue, Lt (Met)/Quicksilver (Met)	27U	96L	ZY4		x	x		Lt Indigo/Indigo	N/A
* Blue, Lt (Met)/White, Summit	27U	50L	ZY4		x	x		Lt Indigo/Indigo	N/A
* Green, Emerald (Met)/Quicksilver (Met)	43U	96L	ZY4			x		Lt Emerald/Emerald	N/A
* Green, Emerald (Met)/Autumnwood, Lt (Met)	43U	55L	ZY4	x				Lt Emerald/Emerald	N/A
* Green, Teal (Met)/Quicksilver (Met)	38U	96L	ZY4			x		Teal/Silver	N/A
* Green, Teal (Met)/White, Summit	38U	50L	ZY4			x		Teal/Silver	N/A
Quicksilver (Met)/Black, Onyx	96U	41L	ZY4			x	x	Gunmetal/Silver	Silver
Quicksilver (Met)/Blue, Indigo (Met)	96U	39L	ZY4		x	x		Lt Indigo/Indigo	Silver
Quicksilver (Met)/Blue, Lt (Met)	96U	27L	ZY4		x	x		Lt Indigo/Indigo	Silver
Quicksilver (Met)/Green, Teal (Met)	96U	38L	ZY4			x		Teal/Silver	Silver
Quicksilver (Met)/Red, Dk Garnet (Met)	96U	34L	ZY4			x	x	Gunmetal/Silver	Silver
Quicksilver (Met)/Red, Victory	96U	74L	ZY4			x	x	Gunmetal/Silver	Silver
Red, Dk Garnet (Met)/Autumnwood, Lt (Met)	84U	55L	ZY4	x			x	Beige/Autumnwood	DK Red
Red, Dk Garnet (Met)/Quicksilver (Met)	84U	96L	ZY4			x	x	Gunmetal/Silver	DK Red
Red, Dk Garnet (Met)/White, Summit	84U	50L	ZY4			x	x	Gunmetal/Silver	DK Red
* Red, Victory/Black, Onyx	74U	41L	ZY4			x	x	Gold/Black	N/A
* Red, Victory/Black, Onyx	74U	41L	ZY4			x	x	Silver/Red	N/A
* Red, Victory/Quicksilver (Met)	74U	96L	ZY4			x	x	Gunmetal/Silver	N/A
* Red, Victory/White, Summit	74U	50L	ZY4	x				Gold/Black	N/A
* Red, Victory/White, Summit	74U	50L	ZY4			x	x	Gunmetal/Silver	N/A

- * N/A C6P on K2500
- ** Color Code 2 Must be ordered as a (+) Plus Option
- *** Leather on Seating Surface Only

3500 PICKUP EQUIPMENT SUMMARY

STANDARD INTERIOR FEATURES

		CHEYENNE	SILVERADO
CUPHOLDERS:	DUAL IN DASH	S	S
DOOR BEAMS:	SIDE IMPACT	S	S
GAGES:	TRIP ODOMETER, OIL PRESSURE, VOLTMETER AND TACHOMETER	S	S
GLASS:	SOLAR RAY TINTED, ALL WINDOWS	S	S
JACK:	WITH WHEEL WRENCH	S	S
INSULATION:	UNDER DASH & FLOOR COVERING	S	S
LIGHTING:	DOME W/LH & RH DOOR SWITCH <u>W/DELAYED ENTRY</u> <u>FEATURE</u> , READING ASHTRAY, GLOVE-BOX, UNDERHOOD & CARGO LAMP	S	S
POWER POINTS:	DUAL COVERED	S	S
SCOTCHGARD:	ALL CLOTH AND CARPET SURFACES	S	S
<u>SEAT BELTS:</u>	<u>ADJUSTABLE HEIGHT, FRONT</u>	S	S
WARNING TONE:	KEY-IN-IGNITION BUZZER	S	S

STANDARD EXTERIOR FEATURES

		CHEYENNE	SILVERADO
FLARES:	FRONT WHEEL OPENING (K3500 ONLY)	S	S
<u>LAMPS:</u>	<u>DAYTIME RUNNING</u>	S	S
SPARE TIRE:	FULL SIZE TIRE & WHEEL, W/WINCH TYPE CARRIER MOUNTED UNDER REAR FRAME	S	S
TOW HOOKS:	TWO FRONT ON 4X4 MODELS	S	S
WIPERS:	INTERMITTENT WINDSHIELD W/PULSE WASHERS	S	S
WIRE HARNESS:	7 WIRE TRAILERING	S	S
WINDOW:	REAR QUARTER SWING-OUT (EXT CAB ONLY)	S	S

STANDARD CHASSIS FEATURES

		CHEYENNE	SILVERADO
BATTERY:	HEAVY-DUTY 600 CCA	S	S
BRAKES:	POWER ASSISTED FRONT DISC, REAR DRUM 4-WHEEL ANTI-LOCK	S	S
<u>ENGINE:</u>	<u>VORTEC 5700 V8 SFI</u>	S	S
<u>EXHAUST SYSTEM:</u>	<u>STAINLESS STEEL</u>	S	S
FUEL TANK:	34 GAL	S	S
GENERATOR:	100 AMP	S	S
<u>STORAGE BOX:</u>	<u>UNDERHOOD, COVERED</u>	S	S
SUSPENSION FRT:	INDEPENDENT COIL W/2WD INDEPENDENT TORSION BAR W/4X4	S	S
SUSPENSION RR:	MULTI-LEAF SPRINGS	S	S
TRANSMISSION:	<u>5-SPEED MANUAL W/DEEP LOW & OVERDRIVE</u>	S	S

BOLD, ITALICS AND UNDERLINED INDICATES NEW FOR '96

REVISED: 1-29-96

1996 ORDER GUIDE

C/K 3500 PICKUP

Page 1

Prices Shown Are Manufacturer's Suggested Retail Prices (MSRP) At The Time Of Publication. These Prices Are To Be Used Only As An Aid To Inventory Management Since MSRP Figures Change Periodically. The Vehicle Price Schedule Is The Official Pricing Documentation Of Chevrolet Motor Division And Should Be Used In Discussing Vehicle Prices With Potential Buyers. The Model Prices Shown In The Order Guide Include The Destination Freight Charges.

**3500 PICKUP
TRIM DEFINITION & OPTION SUMMARY**

INTERIOR TRIM		CHEYENNE	SILVERADO
AIR CONDITIONING:		O	S
ASSIST HANDLES:	PASSENGER	S	S
CONVENIENCE GP:	TILT WHEEL AND CRUISE CONTROL	O	S
DOOR TRIM:	MOLDED PLASTIC W/ARMREST	S	--
	COLOR-KEYED CLOTH AND CARPET TRIMMED	--	S
FLOOR COVERING:	COLOR-KEYED CARPET	O	S
	COLOR-KEYED RUBBER	S	O
	RUBBER FLOOR MATS	O	S
HEADLINER:	COLOR-KEYED CLOTH	S	S
INSULATION:	ADDITIONAL SOUND-DEADENING	--	S
<u>LOCKS:</u>	<u>POWER LOCKS & WINDOWS</u>	--	S
	<u>POWER LOCKS ONLY</u>	O	--
MAP POCKETS:	IN PASSENGER AND DRIVER'S DOOR	S	S
RADIO:	AM/FM STEREO W/SEEK-SCAN AND CLOCK	S	--
	AM/FM STEREO W/SEEK-SCAN, CLOCK AND CASSETTE TAPE	O	S
SEATING:	CLOTH BENCH	O	S
	VINYL BENCH (N/A EXT CAB)	S	O
	CLOTH 60/40 SPLIT BENCH (EXT CAB)	O	S
	VINYL 60/40 SPLIT BENCH (EXT CAB)	S	O
STEERING WHEEL:	SIMULATED LEATHER	S	--
	LEATHER WRAPPED	--	S
STORAGE TRAY:	FULL WIDTH BEHIND SEAT	--	S
SUNSHADES	CLOTH COVERED W/LH STORAGE STRAP, W/RH MIRROR	S	S

EXTERIOR TRIM			
BUMPER FRT:	CHROME	S	--
	CHROME W/BLACK RUB STRIP	O	S
BUMPER RR:	CHROME W/STEP PAD	O	S
CONVENIENCE GP:	POWER WINDOWS, LOCKS	--	S
	POWER LOCKS ONLY	O	--
GRILLE:	MOLDED, PAINTED ARGENT	S	--
	CHROME DELUXE	O	S
HEADLAMPS:	SINGLE RECTANGULAR HALOGEN	S	--
	DUAL COMPOSITE - HALOGEN	O	S
HORN:	SINGLE NOTE	S	--
	DUAL NOTE	O	S
MIRRORS:	BREAK-A-WAY OSRV, BLACK	S	--
	ELECTRIC, REMOTE CONTROL, BLACK	--	S
MOLDINGS:	BODY SIDE WITH BRIGHT TRIM AND BRIGHT WHEEL OPENING TRIM (C3500 & R04)	O	S
NAMEPLATES:	CHEYENNE BADGE ON B-PILLAR	S	--
	SILVERADO BADGE ON B-PILLAR	--	S
PAINT:	SINGLE TONE	S	S
WHEELS:	SILVER PAINTED W/BLACK CENTER CAP	S	--
	RALLY WHEEL TRIM	O	S

BOLD, ITALICS AND UNDERLINED INDICATES NEW FOR '96

MODEL AND BODY

Description	Model No	Body	Wheel Base	Description	Model No	Body	Wheel Base
2-WHEEL-DRIVE MODEL				4-WHEEL-DRIVE MODEL			
*18,701.60 Fleetside	CC30903**	E63	131.5	*21,625.60 Fleetside	CK30903**	E63	131.5
*22,128.00 Fleetside, Ext Cab	CC30953	E63	155.5	*24,839.00 Fleetside, Ext Cab	CK30953	E63	155.5

* Includes Destination & Handling Charges
 ** Reqs R05 Dual or R04 Single Rear Wheels

EMISSIONS (Must Specify One) (Refer Emission Requirements Section)

- FE9 Federal Emission Requirements
- YF5 California Emission Requirements
- NG1 New York/Massachusetts Emission Requirements
- NB8 California or New York/Massachusetts Emission Override (Reqs FE9 Federal Emissions)
- NC7 Federal Emission Override (Reqs YF5 California or NG1 New York/Massachusetts Emissions)

*** GVWR SELECTOR (MUST SPECIFY GVW OPTION)**

Minimum Equipment Required for GVW Rating

GVW Option Required	GVW Rating (lbs)	GAWR*		
		Front	Rear	
C30903				
C6U	3000	3600	6084	Reqs R04 Wheels and YGK or YHH Tires
C7A	4000	3600	7500	Reqs R05 Wheels, N A KL5 Eng
K30903				
C6W	9200	4250	6084	Reqs R04 Wheels and YGK or YHH Tires
C7A	10000	4250	7500	Reqs R05 Wheels
C30953				
C7A	10000	3600	7500	None
K30953				
C7A	10000	3750	7500	None

*GAWR's shown are the minimum for each axle with equipment listed. Other GAWR's are available, and they are determined as the minimum capacity of either axle springs or tires.

CAPACITIES

C30903		AXLES:	
SPRINGS:		AXLES:	
Front		Front	
3600 Base		3800 Base	
3600 w/R05		4250 w/R05	
Rear		Rear	
6084 Base		6084 Base	
7500 w/R05		7500 w/R05	
C30953		AXLES:	
SPRINGS:		AXLES:	
Front		Front	
3800 Base		3800 Base	
Rear		Rear	
7500 Base		7500 Base	

K30903		AXLES:	
SPRINGS:		AXLES:	
Front		Front	
3750 Base		4250 Base	
Rear		Rear	
6084 Base		6084 Base	
7500 w/R05		7500 w/R05	
K30953 <td colspan="2">AXLES:</td>		AXLES:	
SPRINGS: <td colspan="2">AXLES:</td>		AXLES:	
Front		Front	
4250 Base		4250 Base	
Rear		Rear	
7500 Base		7500 Base	

POWER TEAMS (Must Specify Engine, Transmission and Rear Axle)

(Consult GVWR Selector For Minimum Equipment Required)

	ENGINE	TRANSMISSION	AXLE		GVWR
	5-SP H Duty	AUTO H Duty	4.10	4.56	
CC30903					
L31 Vortec 5700 V8 (350 Cu In)--SFI	MW3		(a) GT5	--	9000
		MT1	GT5	--	9000
L31 Vortec 5700 V8 (350 Cu In)--SFI	MW3		(a) GT5	--	10000
		MT1	GT5	(a) HC4	10000
L29 Vortec 7400 V8 (454 Cu In)--SFI	MW3		(a) GT5	--	9000
		MT1	GT5	--	9000
L29 Vortec 7400 V8 (454 Cu In)--SFI	MW3		(a) GT5	(a) HC4	10000
		MT1	GT5	(a) HC4	10000
L65 Turbo Diesel 6.5 Liter V8 H.D. (400 Cu In)	MW3	MT1	--	GT5	9000/10000
CK30903					
L31 Vortec 5700 V8 (350 Cu In)--SFI	MW3		(a) GT5	--	9200
		MT1	GT5	--	9200
L31 Vortec 5700 V8 (350 Cu In)--SFI	MW3		(a) GT5	--	10000
		MT1	GT5	--	10000
L29 Vortec 7400 V8 (454 Cu In)--SFI	MW3		(a) GT5	--	9200
		MT1	GT5	--	9200
L29 Vortec 7400 V8 (454 Cu In)--SFI	MW3		(a) GT5	(a) HC4	10000
		MT1	GT5	(a) HC4	10000
L65 Turbo Diesel 6.5 Liter V8 H.D. (400 Cu In)	MW3	MT1	GT5	--	9200/10000
CC30953					
L31 Vortec 5700 V8 (350 Cu In)--SFI	MW3		(a) GT5	(a) HC4	10000
		MT1	GT5	(a) HC4	10000
L29 Vortec 7400 V8 (454 Cu In)--SFI	MW3		(a) GT5	(a) HC4	10000
		MT1	GT5	HC4	10000
L65 Turbo Diesel 6.5 Liter V8 H.D. (400 Cu In)	MW3	MT1	GT5	--	10000
CK30953					
L31 Vortec 5700 V8 (350 Cu In)--SFI	MW3		(a) GT5	--	10000
		MT1	GT5	--	10000
L29 Vortec 7400 V8 (454 Cu In)--SFI	MW3		(a) GT5	--	10000
		MT1	GT5	(a) HC4	10000
L65 Turbo Diesel 6.5 Liter V8 H.D. (400 Cu In)	MW3	MT1	GT5	--	10000

(a) N/A YFS California Emissions

TIRES: (Must Specify Front and Rear) (Spare Tire and Tire Carrier Included) (Spare Matches Rear Tire)

Description	Single		Dual		On-Off Road	
	Front	Rear	Front	Rear	Single Rear	Dual Rear
C30903 - C30953						
TUBELESS Steel Belted Radial						
LT215/85R16-D B/W	**	XYK		YYK		
LT225/75R16-C B/W		XHE				
LT225/75R16-D B/W				YHP		
LT225/75R16-D B/W						YHR
LT225/75R16-D B/W	*	XHP		YHP		
LT225/75R16-D B/W	*	XHP				YHR
LT245/75R16-E B/W	*	XHH	YHH			
LT245/75R16-E B/W	*	XHH			YGK	
K30903 - K30953						
TUBELESS Steel Belted Radial						
LT215/85R16-D B/W	**	XYK		YYK		
b) LT215/85R16-D B/W					XYL	YYL
LT225/75R16-D B/W				XHR		YHR
LT225/75R16-D B/W	*	XHP		YHP		
a) LT245/75R16-E B/W	*	XHH	YHH			
a) LT245/75R16-E B/W				XGK	YGK	

- * All Seasons
- ** Highway
- a) N.A. K30953
- b) Reqs F60 Front Springs

E W = Blackwall

MUST SPECIFY:

AXLE, EMISSION, ENGINE, TIRES AND TRANSMISSION

Additional Upgrades, Deletions (Where Indicated)

Options may be Ordered from the Custom Ordering Option Listing.

		Reg & Ext Decor		
		CHEYENNE	SILVERADO	
		1 S A	1 S B	1 S C
CHEYENNE DECOR		X	--	--
Fleetside Body Code	E63	X	X	X
SILVERADO DECOR	YE9		X	X
Air Conditioning			X	X
Radio: AM/FM Stereo w/Cassette (A)			X	X
Tilt and Cruise			X	X
SILVERADO DECOR (Leather)				
Regular Cab				
Extended Cab				
Keyless Entry	AUO			X
Mirror, ISRV	DD7			X
Seat, Power (B)	AG9			X
Trim, Leather (C)	AE7			X

(A) May upgrade
 (B) Extended Cab Only
 (C) Must Specify Trim Color; May Upgrade to A95 Seat on Extended Cab

Preferred Equipment Group Prices

Preferred Equipment Group Prices

1SA
PEG Savings
 w/R9A, R9B & R9C
 w/R9A, R9B or R9C
 w/R9A
 w/R9B & R9C
 w/R9B or R9C
 w/o R9A, R9B or R9C

1SB or 1SC

**PEG Savings Amount represents the savings for Preferred Equipment Groups.

REGULAR CAB MARKETING PACKAGES

CONVENIENCE PACKAGE

ORDERING OPTION=R9A

(Reqs Peg 1SA)

Incls :

- C60 Air Conditioning
- UM6 Radio w/Cassette
- ZQ3 Tilt and Cruise

BRIGHT APPEARANCE PACKAGE

ORDERING OPTION=R9B

(Reqs Peg 1SA)

Incls :

- B85 Body Side Moldings (w/o Dual Rear Wheels)
- V22 Chrome Grille
- VB3 Chrome Rear Step Bumper
- VG3 Chromed Front Bumper
- P06 Rally Wheels

COMMERCIAL OPTION PACKAGE

ORDERING OPTION=R9C

(Reqs Peg 1SA) (N/A R9B Bright Appearance Pkg)

Incls :

- BZY Bedliner
- E63 Fleetside
- V43 Painted Step Bumper w/o R9B
- F60 HD Front Springs (K Models Only)
- V76 Tow Hooks (C Models Only)
- NZZ Skid Plate (K Models Only)
- A28 Sliding Rear Window

EXTENDED CAB MARKETING PACKAGES

CONVENIENCE PACKAGE

ORDERING OPTION=R9A

(Reqs Peg 1SA)

Incls :

- C60 Air Conditioning
- UM6 Radio w/Cassette
- ZQ3 Tilt and Cruise

BRIGHT APPEARANCE PACKAGE

ORDERING OPTION=R9B

(Reqs Peg 1SA)

Incls :

- V22 Chrome Grille
- VB3 Chrome Rear Step Bumper
- VG3 Chromed Front Bumper
- P06 Rally Wheels

COMMERCIAL OPTION PACKAGE

ORDERING OPTION=R9C

(Reqs Peg 1SA) (N/A R9B Bright Appearance Pkg)

Incls :

- BZY Bedliner
- E63 Fleetside
- V43 Painted Step Bumper w/o R9B
- F60 HD Front Springs (K Models Only)
- V76 Tow Hooks (C Models Only)
- NZZ Skid Plate (K Models Only)
- A28 Sliding Rear Window

ADDITIONAL OPTIONS

INCL W/DECOR		CHEV- ENNE	SILVER- ADO	OPTION
				ACKNOWLEDGEMENTS
				R8S Multiple Order Numbers
				R8T Preliminary Invoice (Refer Vehicle Price Schedule for Prices)
			x	K47 AIR CLEANER: High Capacity (N/A Diesel Eng)
				C60 AIR CONDITIONING: (Incls R134A Refrigerant)
				w/1SB, 1SC or R9A
				w/1SA
			x	V22 APPEARANCE PACKAGE: (Incls Chrome Grille, Composite Halogen Headlamps and Dual Horns)
				w/1SB, 1SC or R9B
				w/1SA
				AXLES, REAR: (Refer Power Teams Chart for Availability)
				GT5 4:10 Ratio
				HC4 4:56 Ratio (Incls G80 Locking Differential)
				G80 Locking Differential (Included w/HC4 Axle)
				w/HC4
				w/o HC4
				TP2 BATTERY: Heavy-Duty, Auxiliary (N/A Diesel Eng); (Deletes Underhood Storage Box)
				B2Y BEDLINER: Under Rail
				w/R9C
				w/o R9C
				E63 BODY CODE: F eel'side Body
				BUMPER EQUIPMENT:
				EF 1 Bumper Delete Provisions
N/A			x	VB3 Bumper, Chrome, Rear Step w/Rub Strip (Reqs VG3 Bumper or Silverado Decor)
				w/1SB, 1SC or R9B
				w/1SA
			x	VG3 Bumper, Chrome, Front Deluxe w/Rub Strips
				w/1SB, 1SC or R9B
				w/1SA
		N/A		V43 Bumper, Painted, Rear Step
				w/R9C
				w/o R9C
			x	V10 COLD-CLIMATE PACKAGE: (Diesel Eng Reqs Base Decor and Reg Cab) (Incls Eng Block Heater)
				ZQ3 CONVENIENCE GROUP: Tilt-Wheel and Speed Control
				w/1SB, 1SC or R9A
				w/1SA
N/A				C49 DEFOGGER: Rear Window, Electric (N/A A28 Window or C-K30903)
				EMISSIONS: (Refer Emission Requirement Tab Section)
				FE9 Federal Emission Requirements
				YF5 California Emission Requirements
				NG1 New York/Massachusetts State Emissions
				NB8 California or New York/Massachusetts State Emission Override (Reqs FE9 Federal Emissions)
				NC7 Federal Emission Override (Reqs YF5 California or NG1 New York/Massachusetts State Emissions)
				ENGINES: (Refer Power Teams Chart for Availability)
				L31 Vortec 5700 V8 (350 Cu In)--SFI
				L29 Vortec 7400 V8 (454 Cu In)--SFI
				L65 6.5 Liter V8 Turbo Diesel (400 Cu In) (Incls Bumper Guards w/Silverado Decor) (Deletes Underhood Storage Box)
				KL5 Alternative Fuel (LPG & CNG Conversion Ready) (Reqs L31 Eng and MT1 Trans)
				(C/K30903 N/A R05 Dual Rear Wheels)
				FLOOR COVERING:
N/A				BG9 Full Floor, Rubber, Color-Keyed (Replaces Carpeting and Floor Mats) (N/A BYP Sport Pkg)
				w/C-K10*03
				w/C-K10*53
		N/A		B30 Carpet Floor Covering
				w/C-K10*03
				w/C-K10*53
		N/A		B32 Floor Mats (Reqs B30 Floor Covering)
		N/A		B33 Floor Mats (N/A YG4 Seat Delete) (Reqs B30 Carpet, B32 Floor Mats and C-K***53)
				AJ1 GLASS: Deep Tinted, Solar-Ray (When C49 Defogger or A28 Window is Specified, Rear Window is Light Tint Glass)
				N/A C-K30903)
				w/A28 or C49
				w/o A28 or C49
				GVWR: (Must Specify One) (Refer GVWR Selector Chart for Availability)
				C6U 9200#
				C6W 9200#
				C7A 10000#
N/A				AUC KEYLESS ENTRY: (Reqs Silverado Decor)
				w/1SC
				w/o 1SC

INCL W/DECOR		OPTION	
CHEY- ENNE	SILVER- ADD		
		U01	LAMPS: Roof Marker (Standard on C-K30953) (N/A YF5 Calif Emissions w/R04 Rear Wheels) (Incl w/R05 Dual Rear Wheels) w/R05 w/R04
	N/A	VK3	LICENSE PLATE BRACKET: Front
		AU3	LOCKS: Power door
			MIRRORS:
		DF2	Camper Type, Stainless Steel, 7.5" W x 10.5" H, Exterior w/1SB or 1SC w/1SA
N/A		DD7	10" Electrochromic ISRV with 8 Point Compass, Interior
		B85	MOLDING: Exterior, Bright (Incl w/Silverado Decor w/o R05 Dual Rear or w/o K30953) (N/A R05 Dual Rear Wheels or K30953) (K30903 Incls Body Side and Wheel Opening Moldings) (K30903 Incls Body Side Molding Only) w/1SB, 1SC or R9B w/K30903 w/C309*3
			PAINT, EXTERIOR: (Refer Color/Trim Chart for Availability)
		ZY1	Solid
N/A		ZY2	Conventional Two-Tone
N/A		ZY4	Deluxe Two-Tone
			RADIO EQUIPMENT:
		UM6	Electronically Tuned AM/FM Stereo Radio w/Seek-Scan, Stereo Cassette Tape and Digital Clock w/1SB, 1SC or R9A w/1SA
N/A		UL0	Electronically Tuned AM/FM Stereo Radio w/Seek-Scan w/Automatic Tone Control, Digital Clock, Cassette Tape, Theft Lock and Speed Compensated Volume (Incls Enhanced Performance Speaker System)
N/A		UN0	Electronically Tuned AM/FM Stereo Radio w/Seek-Scan w/Automatic Tone Control, Compact Disc Player, Digital Clock, Theft Lock and Speed Compensated Volume (Incls Enhanced Performance Speaker System) (Reqs MT1 Trans)
N/A		UP0	Electronically Tuned AM/FM Stereo Radio w/Seek-Scan w/Automatic Tone Control, Compact Disc Player, Digital Clock, Cassette Tape, Theft Lock and Speed Compensated Volume (Incls Enhanced Performance Speaker System) (Reqs MT1 Trans)
	N/A	UL5	Radio Delete
N/A		AG9	SEAT: Power Driver's Seat (Reqs AE7 Custom Cloth Split Bench or A95 Bucket Seats) (N/A C-K 30903) (N/A Vinyl Trim) w/1SC w/o 1SC
			SEAT TYPE: (Refer Color/Trim Chart for Availability)
		A52	Bench Seat (Incls Storage Armrest and Power Lumbar w/Custom Cloth or Leather Trim) w/1SA or 1SB w/o Leather w/1SB and Leather
		AE7	Reclining Split Bench Seat (Incls Storage Armrest and Power Lumbar w/Custom Cloth or Leather Trim) w/1SC Extended Cab w/1SA or 1SB w/o Leather w/1SB and Leather Regular Cab w/1SA or 1SB w/o Leather w/1SB and Leather
		A95	Reclining High Back Bucket Seats (Incls Power Lumbar) Extended Cab w/1SB w/o Leather or 1SC w/1SB and Leather Regular Cab w/1SC and Leather w/1SB w/o Leather w/1SB and Leather
	N/A	YG4	SEAT DELETE, REAR: (N/A C-K30903)
		NZZ	SKID PLATE: Off-Road (K3500 Only) (Incls Engine Front Differential and Transfer Case Shield) w/R9C w/o R9C
		VYU	SNOW PLOW PREP PACKAGE: (K30903 Only) (Incls F60 HD Front Springs) w/R9C w/o R9C
		F60	SPRINGS, FRONT: Heavy Duty (K3500 Only) (Incl w/VYU Snow Plow) w/VYU or R9C w/o VYU or R9C

**C/K 3500 PICKUP
PAINT APPLICATIONS
WITH ZY1, ZY2 AND ZY4 PAINT SCHEMES**

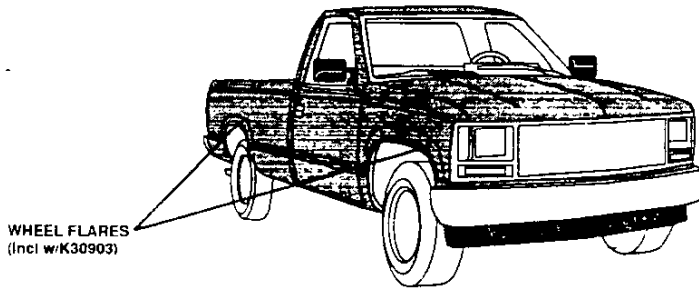

SOLID PAINT - ZY1

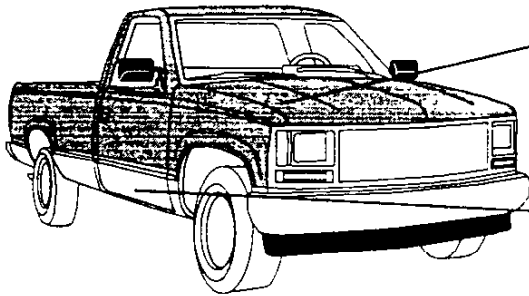

CONVENTIONAL TWO-TONE PAINT - ZY2 w/C30903

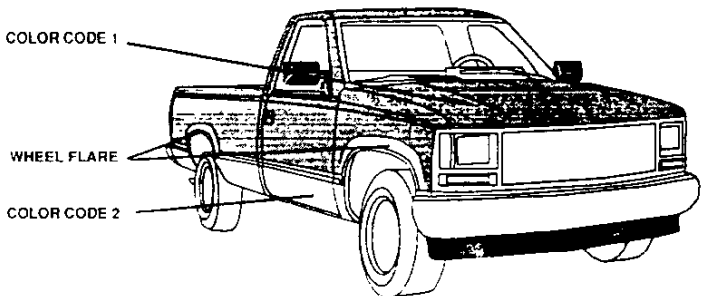

CONVENTIONAL TWO-TONE PAINT - ZY2 w/K30903

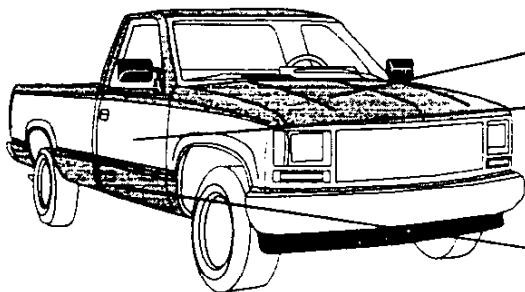

DELUXE TWO-TONE PAINT - ZY4 w/C30903
(Includes Body Striping)

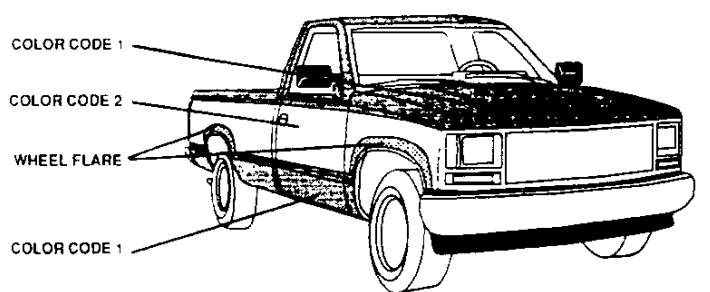

DELUXE TWO-TONE PAINT - ZY4 w/K30903
(Includes Body Striping)

C/K 3500 PICKUP INTERIOR AND EXTERIOR COLOR AVAILABILITY CHART WITH ZY1 PAINT SCHEMES

PLEASE NOTE: Below are the interior trim color and exterior paint combinations recommended by Chevrolet. They are the only available interior and exterior combinations allowed.

TRIM LEVEL (Must Specify Seat Option and Interior Color) Seat Type	SEAT OPT	INTERIOR COLORS			
		Neutral	Blue	Gray	Red
CHEYENNE/X81 WORK TRUCK PKG (STD DECOR)					
REG CAB					
Vinyl Bench Seat	A52	52V	26V	13V	79V
Cloth Bench Seat	A52	52C	26C	13C	79C
EXTENDED CAB					
Vinyl Reclining Split Bench Seat	AE7	52V	26V	13V	79V
Cloth Reclining Split Bench Seat	AE7	52C	26C	13C	79C
SILVERADO DECOR					
REGULAR CAB					
Vinyl Bench Seat	A52	52V	26V	13V	79V
Custom Cloth Bench Seat	A52	52D	26D	13D	79D
Custom Leather Bench Seat	A52	522	262	132	792
Custom Cloth Reclining Split Bench Seat	AE7	52D	26D	13D	79D
Custom Leather Reclining Split Bench Seat	AE7	522	262	132	792
Custom Cloth Reclining High Back Bkt Seats	A95	52D	26D	13D	79D
EXTENDED CAB					
Vinyl Reclining Split Bench Seat	AE7	52V	26V	13V	79V
Custom Cloth Reclining Split Bench Seat	AE7	52D	26D	13D	79D
Custom Leather Reclining Split Bench Seat	AE7	522	262	132	792
Custom Cloth Reclining High Back Bkt Seats	A95	52D	26D	13D	79D
Custom Leather Reclining High Back Bkt Seats	A95	522	262	132	792

EXTERIOR COLORS	Color Code	PAINT SCHEME	INTERIOR & EXTERIOR COMBINATIONS SHOWN ARE THE ONLY COMBINATIONS AVAILABLE				**K3500 Wheel Flare Color
AUTUMNWOOD, LT (Metallic)	55U	ZY1	x				Autumnwood, Lt
BLACK, ONYX	11U	ZY1	x		x	x	Black
BLUE, INDIGO (Metallic)	39U	ZY1	x	x	x		Indigo
BLUE, LT (Metallic)	27U	ZY1		x	x		Dk Argent
GREEN, EMERALD (Metallic)	43U	ZY1	x		x		Dk Argent
GREEN, TEAL (Metallic)	38U	ZY1	x		x		Dk Argent
QUICKSILVER (Metallic) **	96U	ZY1		x	x	x	Silver
RED, DK GARNET (Metallic)	84U	ZY1	x		x	x	Red, Dk Garnet
RED, VICTORY	74U	ZY1	x		x	x	Dk Argent
WHITE, SUMMIT	50U	ZY1	x	x	x	x	Dk Argent

* Leather on Seating Surface Only

** Included on Front Only w/ Dual Rear Wheels

C/K 3500 PICKUP INTERIOR AND EXTERIOR COLOR AVAILABILITY CHART ZY2 PAINT SCHEMES

PLEASE NOTE: Below are the interior trim color and exterior paint combinations recommended by Chevrolet. They are the only available interior and exterior combinations allowed.

TRIM LEVEL (Must Specify Seat Option and Interior Color) Seat Type	SEAT OPT	INTERIOR COLORS			
		Neutral	Blue	Gray	Red
SILVERADO DECOR					
REGULAR CAB					
Vinyl Bench Seat	A52	52V	26V	13V	79V
Custom Cloth Bench Seat	A52	52D	26D	13D	79D
*** Custom Leather Bench Seat	A52	522	262	132	792
Custom Cloth Reclining Split Bench Seat	AE7	52D	26D	13D	79D
*** Custom Leather Reclining Split Bench Seat	AE7	522	262	132	792
Custom Cloth Reclining High Back Bkt Seats	A95	52D	26D	13D	79D
EXTENDED CAB					
Vinyl Reclining Split Bench Seat	AE7	52V	26V	13V	79V
Custom Cloth Reclining Split Bench Seat	AE7	52D	26D	13D	79D
*** Custom Leather Reclining Split Bench Seat	AE7	522	262	132	792
Custom Cloth Reclining High Back Bkt Seats	A95	52D	26D	13D	79D
*** Custom Leather Reclining High Back Bkt Seats	A95	522	262	132	792

EXTERIOR COLORS	Color Code 1	Color **Code 2	PAINT SCHEME	INTERIOR & EXTERIOR COMBINATIONS SHOWN ARE THE ONLY COMBINATIONS AVAILABLE				K3500 WHEEL FLARE
Black, Onyx/Autumnwood, Lt (Met)	41U	56L	ZY2	x				Autumnwood
Black, Onyx/Quicksilver (Met)	41U	96L	ZY2			x	x	Silver
Blue, Indigo (Met)/Autumnwood, Lt (Met)	39U	55L	ZY2	x	x			Autumnwood
* Blue, Indigo (Met)/Blue, Lt (Met)	39U	27L	ZY2		x	x		N/A
Blue, Indigo (Met)/Quicksilver (Met)	39U	96L	ZY2		x	x		Silver
Blue, Lt (Met)/Blue, Indigo (Met)	27U	39L	ZY2		x	x		Indigo
Blue, Lt (Met)/Quicksilver (Met)	27U	96L	ZY2		x	x		Silver
Green, Emerald (Met)/Autumnwood, Lt (Met)	43U	55L	ZY2	x				Autumnwood
Green, Emerald (Met)/Quicksilver (Met)	43U	96L	ZY2			x		Silver
Green, Teal (Met)/Autumnwood, Lt (Met)	38U	55L	ZY2	x				Autumnwood
Green, Teal (Met)/Quicksilver (Met)	38U	96L	ZY2			x		Silver
* Green, Teal (Met)/White, Summit	38U	50L	ZY2			x		N/A
Quicksilver (Met)/Black, Onyx	96U	41L	ZY2			x	x	Black
Quicksilver (Met)/Blue, Indigo (Met)	96U	39L	ZY2		x	x		Indigo
* Quicksilver (Met)/Blue, Lt (Met)	96U	27L	ZY2		x	x		N/A
Quicksilver (Met)/Red, Dk Garnet (Met)	96U	84L	ZY2			x		Dk Red
Red, Dk Garnet (Met)/Autumnwood, Lt (Met)	84U	55L	ZY2	x			x	Autumnwood
Red, Dk Garnet (Met)/Quicksilver (Met)	84U	96L	ZY2			x	x	Silver
Red, Victory/Black, Onyx	74U	41L	ZY2	x		x	x	Black
Red, Victory/Quicksilver (Met)	74U	96L	ZY2			x	x	Silver

* N/A K3500

** Color Code 2 Must be ordered as a (+) Plus Option

*** Leather on Seating Surface Only

C/K 3500 PICKUP INTERIOR AND EXTERIOR COLOR AVAILABILITY CHART ZY4 PAINT SCHEMES

PLEASE NOTE: Below are the interior trim color and exterior paint combinations recommended by Chevrolet. They are the only available interior and exterior combinations allowed.

TRIM LEVEL (Must Specify Seat Option and Interior Color) Seat Type	SEAT OPT	INTERIOR COLORS			
		Neutral	Blue	Gray	Red
SILVERADO DECOR					
REGULAR CAB					
Vinyl Bench Seat	A52	52V	26V	13V	79V
Custom Cloth Bench Seat	A52	52D	26D	13D	79D
*** Custom Leather Bench Seat	A52	522	262	132	792
Custom Cloth Reclining Split Bench Seat	AE7	52D	26D	13D	79D
*** Custom Leather Reclining Split Bench Seat	AE7	522	262	132	792
Custom Cloth Reclining High Back Bkt Seats	A95	52D	26D	13D	79D
EXTENDED CAB					
Vinyl Reclining Split Bench Seat	AE7	52V	26V	13V	79V
Custom Cloth Reclining Split Bench Seat	AE7	52D	26D	13D	79D
*** Custom Leather Reclining Split Bench Seat	AE7	522	262	132	792
Custom Cloth Reclining High Back Bkt Seats	A95	52D	26D	13D	79D
*** Custom Leather Reclining High Back Bkt Seats	A95	522	262	132	792

EXTERIOR COLORS	Color Code 1	**Color Code 2	PAINT SCHEME	INTERIOR & EXTERIOR COMBINATIONS SHOWN ARE THE ONLY COMBINATIONS AVAILABLE				STRIPE COLORS Top-Lower/Center	K3500 WHEEL FLARE COLOR
				Neutral	Blue	Gray	Red		
Black, Onyx/Autumnwood, Lt (Met)	41U	55L	ZY4	x				Beige/Autumnwood	Black
Black, Onyx/Quicksilver (Met)	41U	96L	ZY4			x	x	Gunmetal/Silver	Black
Black, Onyx/Red, Victory (Met)	41U	74L	ZY4			x	x	Silver/Red	Black
Black, Onyx/Red, Victory (Met)	41U	74L	ZY4	x				Gold/Black	Black
Blue, Indigo (Met)/Blue, Lt (Met)	39U	27L	ZY4		x	x		Lt Indigo/Indigo	Blue
Blue, Indigo (Met)/Quicksilver (Met)	39U	96L	ZY4		x	x		Lt Indigo/Indigo	Blue
Blue, Indigo (Met)/White, Summit	39U	50L	ZY4		x	x		Lt Indigo/Indigo	Blue
* Blue, Lt (Met)/Blue, Indigo (Met)	27U	39L	ZY4		x	x		Lt Indigo/Indigo	N/A
* Blue, Lt (Met)/Quicksilver (Met)	27U	96L	ZY4		x	x		Lt Indigo/Indigo	N/A
* Blue, Lt (Met)/White, Summit	27U	50L	ZY4		x	x		Lt Indigo/Indigo	N/A
* Green, Emerald (Met)/Quicksilver (Met)	43U	96L	ZY4			x		Lt Emerald/Emerald	N/A
* Green, Emerald (Met)/Autumnwood, Lt (Met)	43U	55L	ZY4	x				Lt Emerald/Emerald	N/A
* Green, Teal (Met)/Quicksilver (Met)	38U	96L	ZY4			x		Teal/Silver	N/A
* Green, Teal (Met)/White, Summit	38U	50L	ZY4			x		Teal/Silver	N/A
Quicksilver (Met)/Black, Onyx	96U	41L	ZY4			x	x	Gunmetal/Silver	Silver
Quicksilver (Met)/Blue, Indigo (Met)	96U	39L	ZY4		x	x		Lt Indigo/Indigo	Silver
Quicksilver (Met)/Blue, Lt (Met)	96U	27L	ZY4		x	x		Lt Indigo/Indigo	Silver
Quicksilver (Met)/Green, Teal (Met)	96U	38L	ZY4			x		Teal/Silver	Silver
Quicksilver (Met)/Red, Dk Garnet (Met)	96U	84L	ZY4			x	x	Gunmetal/Silver	Silver
Quicksilver (Met)/Red, Victory	96U	74L	ZY4			x	x	Gunmetal/Silver	Silver
Red, Dk Garnet (Met)/Autumnwood, Lt (Met)	84U	55L	ZY4	x			x	Beige/Autumnwood	Dk Red
Red, Dk Garnet (Met)/Quicksilver (Met)	84U	96L	ZY4			x	x	Gunmetal/Silver	DK Red
Red, Dk Garnet (Met)/White, Summit	84U	50L	ZY4			x	x	Gunmetal/Silver	DK Red
* Red, Victory/Black, Onyx	74U	41L	ZY4				x	Gold/Black	N/A
* Red, Victory/Black, Onyx	74U	41L	ZY4			x		Silver/Red	N/A
* Red, Victory/Quicksilver (Met)	74U	96L	ZY4			x	x	Gunmetal/Silver	N/A
* Red, Victory/White, Summit	74U	50L	ZY4	x				Gold/Black	N/A
* Red, Victory/White, Summit	74U	50L	ZY4			x	x	Gunmetal/Silver	N/A

* N/A K3500

** Color Code 2 Must be ordered as a (+) Plus Option

*** Leather on Seating Surface Only

3500 CREW CAB PICKUP EQUIPMENT SUMMARY

STANDARD INTERIOR FEATURES		CHEYENNE	SILVERADO
CUPHOLDERS:	DUAL IN DASH	S	S
DOOR BEAMS:	SIDE IMPACT	S	S
GAUGES:	TRIP ODOMETER, OIL PRESSURE, VOLTMETER AND TACHOMETER	S	S
GLASS:	SOLAR RAY TINTED, ALL WINDOWS	S	S
HEATING DUCT:	REAR SEAT	S	S
JACK:	WITH WHEEL WRENCH	S	S
INSULATION:	UNDER DASH & FLOOR COVERING	S	S
LIGHTING:	DOME W/LH & RH DOOR SWITCH <u>W/DELAYED ENTRY</u> <u>FEATURE</u> , READING, ASHTRAY, GLOVE-BOX, UNDERHOOD & CARGO LAMPS	S	S
POWER POINTS:	DUAL COVERED	S	S
SCOTCHGARD:	ALL CLOTH AND CARPET SURFACES	S	S
<u>SEAT BELTS:</u>	<u>ADJUSTABLE HEIGHT, FRONT</u>	S	S
WARNING TONE:	KEY-IN-IGNITION BUZZER	S	S

STANDARD EXTERIOR FEATURES		CHEYENNE	SILVERADO
FLARES:	<u>FRONT AND REAR (K3500 ONLY)</u>	S	S
<u>LAMPS:</u>	<u>DAYTIME RUNNING</u>	S	S
SPARE TIRE:	FULL SIZE TIRE & WHEEL, W/WINCH TYPE CARRIER MOUNTED UNDER REAR FRAME	S	S
TAILGATE:	REMOVABLE	S	S
TOW HOOKS:	TWO FRONT ON 4X4 MODELS	S	S
WIPERS:	INTERMITTENT WINDSHIELD W/PULSE WASHERS	S	S
WIRE HARNESS:	7 WIRE TRAILERING	S	S

STANDARD CHASSIS FEATURES		CHEYENNE	SILVERADO
BATTERY:	HEAVY-DUTY 600 CCA	S	S
BRAKES:	POWER ASSISTED FRONT DISC, REAR DRUM 4-WHEEL ANTI-LOCK	S	S
<u>ENGINE:</u>	<u>VORTEC 5700 V8 SFI</u>	S	S
<u>EXHAUST SYSTEM:</u>	<u>STAINLESS STEEL</u>	S	S
FUEL TANK:	34 GAL	S	S
GENERATOR:	100 AMP	S	S
<u>STORAGE BOX:</u>	<u>UNDERHOOD, COVERED</u>	S	S
SUSPENSION FRT:	INDEPENDENT COIL W/2WD INDEPENDENT TORSION BAR W/4X4	S	S
SUSPENSION RR:	MULTI-LEAF SPRINGS	S	S
TRANSMISSION:	5-SPEED MANUAL W/DEEP LOW & OVERDRIVE	S	S

BOLD, ITALICS AND UNDERLINED INDICATES NEW FOR '96

REVISED: 1-29-96

1996 ORDER GUIDE

C/K 3500 CREW CAB PICKUP

Page 1

Prices Shown Are Manufacturer's Suggested Retail Prices (MSRP) At The Time Of Publication. These Prices Are To Be Used Only As An Aid To Inventory Management Since MSRP Figures Change Periodically. The Vehicle Price Schedule Is The Official Pricing Documentation Of Chevrolet Motor Division And Should Be Used In Discussing Vehicle Prices With Potential Buyers. The Model Prices Shown In The Order Guide Include The Destination Freight Charges.

3500 CREW CAB PICKUP TRIM DEFINITION & OPTION SUMMARY

INTERIOR TRIM

	CHEYENNE	SILVERADO
AIR CONDITIONING:	O	S
ASSIST HANDLES: PASSENGER	S	S
CONVENIENCE GP: CRUISE CONTROL AND TILT WHEEL	O	S
POWER WINDOWS, LOCKS	--	S
POWER LOCKS ONLY	O	--
DOOR TRIM: MOLDED PLASTIC W/ARMREST	S	--
COLOR-KEYED CLOTH AND CARPET TRIM	--	S
FLOOR COVERING: COLOR-KEYED CARPET, W/MATS	--	S
BLACK RUBBER	S	--
HEADLINER: COLOR-KEYED CLOTH	S	S
INSULATION: ADDITIONAL SOUND-DEADENING	--	S
MAP POCKETS: IN PASSENGER AND DRIVER'S DOOR	S	S
<u>MIRROR:</u> <u>10" ELECTROCHROMIC ISRV WITH 8 POINT COMPASS</u>	O	S
RADIO: AM/FM STEREO W/SEEK-SCAN AND CLOCK	S	--
AM/FM STEREO W/SEEK-SCAN, CLOCK AND CASSETTE TAPE	O	S
SEATING: VINYL BENCH	S	S
STEERING WHEEL: SIMULATED LEATHER	S	--
LEATHER WRAPPED	--	S
SUNSHADES CLOTH COVERED W/LH STORAGE STRAP & RH MIRROR	S	--
LH STORAGE STRAP AND LH/RH LIGHTED MIRRORS AND EXTENDERS	--	S

EXTERIOR TRIM

	CHEYENNE	SILVERADO
BUMPER FRT: CHROME	S	--
CHROME W/BLACK RUB STRIP	O	S
BUMPER RR: CHROME W/STEP PAD	O	S
GRILLE: MOLDED, PAINTED ARGENT	S	--
CHROME DELUXE	O	S
HEADLAMPS: SINGLE RECTANGULAR HALOGEN	S	--
DUAL COMPOSITE - HALOGEN	O	S
HORN: SINGLE NOTE	S	--
DUAL NOTE	O	S
MIRRORS: BREAK-A-WAY OSRV, BLACK	S	--
ELECTRIC, REMOTE CONTROL: BLACK	--	S
NAMEPLATES: CHEYENNE BADGE ON B-PILLAR	S	--
SILVERADO BADGE ON B-PILLAR	--	S
PAINT: SINGLE TONE	S	S
WHEELS: SILVER PAINTED W/BLACK CENTER CAP	S	--
RALLY WHEEL TRIM	O	S

BOLD, ITALICS AND UNDERLINED INDICATES NEW FOR '96

C/K 3500 CREW CAB PICKUP

MODEL AND BODY

(Reqs R05 Dual or R04 Single Rear Wheels)

Description	Model No	Body	Wheel Base
2-WHEEL DRIVE MODEL			
Fleetside	CC30943	E63	168.5

Description	Model No	Body	Wheel Base
4-WHEEL DRIVE MODEL			
Fleetside	CK30943	E63	168.5

*Includes Destination & Handling Charges

*GVWR SELECTOR (MUST SPECIFY GVW OPTION)

GVW Option Required	GVW Rating (lbs)	Minimum Equipment Required For GVW Rating		
		*GAWR Front	*GAWR Rear	
C30943				
C6U	9000	4100	6084	N/A R05 Wheels
C7A	10000	4100	7500	Reqs R05 Wheels
K30943				
C6W	9200	4500	6084	N/A R05 Wheels
C7A	10000	4500	7500	Reqs R05 Wheels

*GAWR's shown are the minimum for each axle with equipment listed

CAPACITIES

C30943			
SPRINGS:		AXLES:	
Front		Front	
4100	Base	4100	Base
Rear		Rear	
6084	Base	6084	Base
7500	w/R05	7500	w/R05

K30943			
SPRINGS:		AXLES:	
Front		Front	
4500	Base	4500	Base
Rear		Rear	
6084	Base	6084	Base
7500	w/R05	7500	w/R05

C/K 3500 CREW CAB PICKUP

EMISSIONS (Must Specify One) (Refer Emission Requirements Section)

- FE9 Federal Emission Requirements
- YF5 California Emission Requirements
- NG1 New York/Massachusetts Emission Requirements
- NB8 California or New York/Massachusetts Override (Reqs FE9 Federal Emissions)
- NC7 Federal Emission Override (Reqs YF5 California or NG1 New York/Massachusetts Emissions)

POWER TEAMS (Must Specify Engine, Transmission and Rear Axle)

(Consult GVWR Selector For Minimum Equipment Required)

ENGINE	TRANSMISSION	AXLE	GVWR		
	5-SP	AUTO	4.10	4.56	
HEAVY DUTY					
CC30943					
L31 V8 5700 Vortec 350 Cu In. SFI	MW3	MT1	(a) GT5 GT5	(b) HC4 (c) HC4	3000/10000 9000/10000
L29 V8 7400 Vortec 454 Cu In. SFI	MW3	MT1	(a) GT5 GT5	(b) HC4 (c) HC4	3000/10000 9000/10000
L65 Turbo Diesel 6.5 Liter V8 H.D. 400 Cu In.	MW3	MT1	GT5	--	3000/10000
CK30943					
L31 V8 5700 Vortec 350 Cu In. SFI	MW3	MT1	(a) GT5 GT5	(b) HC4 (c) HC4	9200/10000 9200/10000
L29 V8 7400 Vortec 454 Cu In. SFI	MW3	MT1	(a) GT5 GT5	(b) HC4 (c) HC4	9200/10000 9200/10000
L65 Turbo Diesel 6.5 Liter V8 H.D. 400 Cu In.	MW3	MT1	GT5	--	9200/10000

- (a) Reqs Federal Emissions
- (b) Reqs Federal Emissions and C7A GVW
- (c) Reqs C7A GVW

TIRES: (Must Specify Front and Rear) (Spare Tire and Tire Carrier Included) (Spare Matches Rear Tire)

Description	Front	* All Season ** Highway Single Rear	Dual Rear	On-Off Road		
				Front	Single Rear	Dual Rear
C30943						
TUBELESS Steel Belted Radial						
LT215/85R16-D B.W	** XYK		YYK			
LT225/75R16-D B.W	* XHP		YHP			
	* XHP					YHR
LT245/75R16-E 3 W	* XHH	YHH				
	* XHH					YGK
K30943						
TUBELESS Steel Belted Radial						
LT215/85R16-D B.W	** XYK		YYK			
a)LT215/85R16-D B.W				XYL		YYL
LT225/75R16-D 3 W				XHR		YHR
LT225/75R16-D B.W	* XHP		YHP			
LT245/75R16-E 3 W				XGK		YGK
LT245/75R16-E 3 W	* XHH	YHH				

- (a) Reqs F60 Front Springs
- BW = Backwall

C/K 3500 CREW CAB PICKUP

MUST SPECIFY:

AXLE, EMISSION, ENGINE, TIRES AND TRANSMISSION

**No Deletions Allowed. Additional Options/Upgrades (Where Indicated)
May be Ordered from the Custom Ordering Option Listing.**

	SILVERADO		
	CHEYENNE	1 S A	1 S C
CHEYENNE DECOR			
Fleetside Body Code	x	--	
SILVERADO DECOR			
Air Conditioning		x	x
Radio: AM/FM Stereo w/Cassette (A)		x	x
Tilt and Cruise		x	x
SILVERADO DECOR (Leather)			
Keyless Entry			x
Seat. Power			x
Trim, Leather Split Bench Seat (A)			x

(A) May upgrade

CREW CAB PICKUP MARKETING PACKAGES

CONVENIENCE PACKAGE \$1,335.00

ORDERING OPTION=R9A

(Reqs Peg 1SA)

Incls :

- C60 Air Conditioning
- UM6 Radio w/Cassette
- ZQ3 Tilt and Cruise

C/K 3500 CREW CAB PICKUP

ADDITIONAL OPTIONS

INCL W/DECOR		OPTION
CHEV- ENNE	SILVER- ADO	
		ACKNOWLEDGEMENTS:
		R8S Multiple Order Numbers
		R8T Preliminary Invoice (Refer Vehicle Price Schedule for Prices)
	x	K47 AIR CLEANER: High Capacity (N/A Diesel Eng)
		C60 AIR CONDITIONING: (Incls R134A Refrigerant)
		w/1SB, 1SC or R9A
		w/1SA
	x	V22 APPEARANCE PACKAGE: (Incls Chrome Grille, Composite Halogen Headlamps and Dual Horns)
		w/1SB, 1SC or R9A
		w/1SA
		R9B APPEARANCE PACKAGE: BRIGHT
		AXLES, REAR (Refer Power Teams Chart for Availability)
		G15 4.10 Ratio
		HC4 4.56 Ratio (Incls G80 Locking Differential)
		G80 Locking Differential (Includes w/HC4 Axle)
		w/HC4
		w/o HC4
		TP2 BATTERY: Heavy-Duty, Auxiliary (N/A L65 Eng) (Deletes Underhood Storage Box)
		BZY BEDLINER: Under-rail
		E63 BODY CODE: Feet of Deck
		BUMPER EQUIPMENT:
		EF1 Bumper Delete Provisions: N/A 282 Trailering)
	x	VB3 Bumper, Chrome Rear Step
		w/1SB, 1SC or R9B
		w/o 1SA
	N/A	V43 Bumper, Painted Rear (Reqs Cheyenne Decor)
		V10 COLD CLIMATE PACKAGE: N/A L65 Eng; (Incls Eng Block Heater)
		CONVENIENCE PACKAGES:
	x	ZQ3 Tire Wheel and Speed Control
		w/1SB, 1SC or R9A
		w/1SA
		C49 DEFOGGER: Rear Window Electric (N/A A28 Sliding Rear Window) (Reqs C60 Air)
		EMISSIONS: (Refer Emission Requirement Tab Section)
		FE9 Federal Emission Requirements
		YF5 California Emission Requirements
		NG1 New York/Massachusetts Emission Requirements
		NC8 California or New York/Massachusetts Emission Override (Reqs FE9 Federal Emissions)
		NC7 Federal Emission Override (Reqs YF5 California or NG1 New York/Massachusetts Emissions)
		ENGINES: (Refer Power Teams Chart for Availability)
		L31 V8 5700 Vortec (350 Cu In)-SFI HD
		L29 V8 7400 Vortec (454 Cu In)-SFI
		L65 V8 6.5 Liter Turbo Diesel (400 Cu In)-EFI (Incls Front Bumper Guards) (Deletes Underhood Storage Box)
		AJ1 GLASS: Deep Tint (Incls Light Tinted Rear Window when A28 Sliding Rear Window is Specified)
		GVWR: (Must Specify One) (Refer GVWR Selector Chart for Availability)
		C6U 9000#
		C6W 9200#
		C7A 10000#
	N/A	AUC KEYLESS ENTRY: Remote
		w/1SC
		w/o 1SC
		U01 LAMPS: Roof Marker (N/A YF5 Calif Emission w/R04 Rear Wheels) (Incl w/R05 Dual Rear Wheels)
		w/R05
		w/R04
		VK3 LICENSE PLATE BRACKET: Front
	x	AU3 LOCKS, POWER DOOR: (Reqs Base PEG)
		MIRRORS:
		DF2 Camper Type, Stainless Steel 7.5" W x 10.5" H, Exterior
		w/1SB or 1SC
		w/1SA

ADDITIONAL OPTIONS

INCL W/DECOR		OPTION
CHEV- ENNE	SILVER- ADO	
		ZY1 PAINT: (Refer Color/Trim Chart for Availability) Solid
	x	UM6 RADIO EQUIPMENT: Electronically Tuned AM/FM Stereo Radio w/Seek-Scan, Stereo Cassette Tape and Digital Clock w/1SB, 1SC or R9A w/1SA
N/A		UL0 Electronically Tuned AM/FM Stereo Radio w/Seek-Scan w/Automatic Tone Control, Digital Clock, Cassette Tape, Theft Lock and Speed Compensated Volume (w/Silverado Decor Incis an Enhanced Performance Speaker System)
N/A		UN0 Electronically Tuned AM/FM Stereo Radio w/Seek-Scan w/Automatic Tone Control, Compact Disc Player, Digital Clock, Theft Lock and Speed Compensated Volume (w/Silverado Decor Incis an Enhanced Performance Speaker System)
N/A		UP0 Electronically Tuned AM/FM Stereo Radio w/Seek-Scan w/Automatic Tone Control, Compact Disc Player, Digital Clock, Cassette Tape, Theft Lock and Speed Compensated Volume (w/Silverado Decor Incis an Enhanced Performance Speaker System) (Reqs MT1 Trans)
	N/A	UL5 Radio Delete
N/A		AG9 SEATING: Power Driver's Seat (N/A A52 Bench Seat)
		A52 SEAT TYPE: (Refer Color/Trim Chart for Availability) Front Bench Seat (Incls Storage Armrest and Power Lumbar w/Custom Cloth or Leather Trim) w/1SB with Leather w/1SA or w/1SB w/o Leather
		AE7 Front 60/40 Split Bench Seat (Incls Storage Armrest and Power Lumbar w/Custom Cloth or Leather Trim) w/1SC w/1SA or with 1SB w/o Leather w/1SB w/Leather
		A95 Front, Bucket, High Back, Reclining (Incls Floor and Overhead Console) (Incls Power Lumbar)
		NZZ SKID PLATE PACKAGE: (K30943 Only) (Incls Eng, Front Differential and Transfer Case Shields)
		F60 SPRINGS: Front, Heavy-Duty (K30943 Only)
		V76 TIRES: (Refer Tire Chart for Availability and Vehicle Price Schedule for Prices)
		Z82 TOW HOOKS: (Std on K30943)
		MW3 TRAILERING PACKAGE: (Incls Trailer Hitch Platform) (Reqs V83 or V43 Bumper)
		MT1 TRANSMISSIONS: (Refer Power Teams Chart for Availability) 5-Speed Heavy Duty Manual w/Deep Low and Overdrive, Heavy-Duty
		P06 4-Speed Electronically Controlled Automatic w/Overdrive, Heavy-Duty (Incls Transmission Oil Cooler)
		WHEEL TRIM: Rally Wheel w/1SB, 1SC or R9B w/1SA
		WHEELS, REAR: (Must Specify One)
		R04 Single Rear
		R05 Dual Rear (Reqs C7A GVWR) (Incls U01 Roof Marker and Tailgate Lamps)
		A28 WINDOW: Strong Rear

C/K 3500 CREW CAB PICKUP

CREW CAB PICKUP INTERIOR AND EXTERIOR COLOR AVAILABILITY CHART ZY1 PAINT

PLEASE NOTE: Below are the interior trim color and exterior paint combinations recommended by Chevrolet. They are the only available interior and exterior combinations allowed.

TRIM LEVEL (Must Specify Seat Option and Interior Color) Seat Type	SEAT OPT	INTERIOR COLORS			
		Neutral	Blue	Gray	Red
CHEYENNE (STD DECOR) 79V Bench Seat	A52	52V	26V	13V	79V
SILVERADO DECOR					
Custom Cloth Bench Seat	A52	52D	26D	13D	79D
* Custom Leather Bench Seat	A52	522	262	132	792
Custom Cloth Reclining Split Bench Seat	AE7	52D	26D	13D	79D
* Custom Leather Reclining Split Bench Seat	AE7	522	262	132	792
Custom Cloth Reclining High Back Bucket Seats Incis Roof/Floor Console	A95	52D	26D	13D	79D

EXTERIOR COLORS	Color Code	PAINT SCHEME	INTERIOR & EXTERIOR COMBINATIONS SHOWN ARE THE ONLY COMBINATIONS AVAILABLE				**K3500 Wheel Flare Color
AUTUMNWOOD, LT (Met)	55U	ZY1	x				Autumnwood, Lt
BLACK, ONYX	41U	ZY1	x	x	x	x	Dk Argent
BLUE, INDIGO (Met)	39U	ZY1	x	x	x		Indigo
BLUE, LT (Met)	27U	ZY1		x	x		Dk Argent
QUICKSILVER (Met)	96U	ZY1		x	x	x	Silver
RED, VICTORY	74U	ZY1	x		x	x	Dk Argent
WHITE, SUMMIT	50U	ZY1	x	x	x	x	Dk Argent

* Leather on Seating Surface Only

** Included on Front Only w/Dual Rear Wheels

SOLID PAINT - ZY1

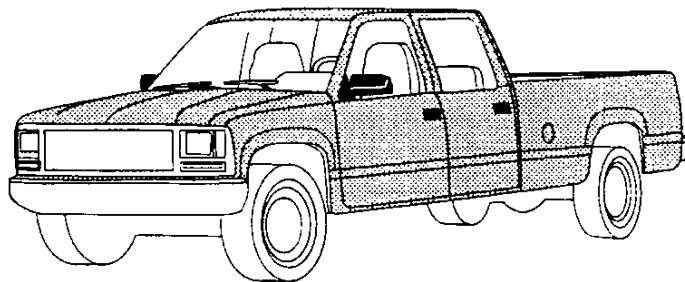

2500 CHASSIS CAB EQUIPMENT SUMMARY

STANDARD INTERIOR FEATURES		CHEYENNE	SILVERADO
CUPHOLDERS:	DUAL IN DASH	S	S
DOOR BEAMS:	SIDE IMPACT	S	S
GAGES:	TRIP ODOMETER, OIL PRESSURE, VOLTMETER AND TACHOMETER	S	S
GLASS:	SOLAR RAY TINTED, ALL WINDOWS	S	S
JACK:	WITH WHEEL WRENCH	S	S
INSULATION:	UNDER DASH & FLOOR COVERING	S	S
<u>LIGHTING:</u>	DOME W/LH & RH DOOR SWITCH <u>W/DELAYED ENTRY FEATURE</u> , READING, ASHTRAY, GLOVE-BOX AND UNDERHOOD	S	S
POWER POINTS:	DUAL COVERED	S	S
SCOTCHGARD:	ALL CLOTH AND CARPET SURFACES	S	S
<u>SEAT BELTS:</u>	<u>ADJUSTABLE HEIGHT, FRONT</u>	S	S
WARNING TONE:	KEY-IN-IGNITION BUZZER	S	S
STANDARD EXTERIOR FEATURES		CHEYENNE	SILVERADO
FLARES:	FRONT WHEEL OPENING (K2500 ONLY)	S	S
<u>LAMPS:</u>	<u>DAYTIME RUNNING</u>	S	S
TOW HOOKS:	TWO FRONT ON 4X4 MODELS	S	S
WIPERS:	INTERMITTENT WINDSHIELD W/PULSE WASHERS	S	S
WIRE HARNESS:	7 WIRE TRAILERING	S	S
STANDARD CHASSIS FEATURES		CHEYENNE	SILVERADO
BATTERY:	HEAVY-DUTY 600 CCA	S	S
BRAKES:	POWER ASSISTED FRONT DISC, REAR DRUM 4-WHEEL ANTI-LOCK	S	S
<u>ENGINE:</u>	<u>VORTEC 5700 V8 SEI</u>	S	S
<u>EXHAUST SYSTEM:</u>	<u>STAINLESS STEEL</u>	S	S
FUEL TANK:	34 GALLON	S	S
GENERATOR:	100 AMP	S	S
<u>STORAGE BOX:</u>	<u>UNDERHOOD, COVERED</u>	S	S
SUSPENSION FRT:	INDEPENDENT COIL W/2WD INDEPENDENT TORSION BAR W/4X4	S	S
SUSPENSION RR:	MULTI-LEAF SPRINGS	S	S
TRANSMISSION:	5-SPEED MANUAL W/DEEP LOW & OVERDRIVE	S	S

BOLD, ITALICS AND UNDERLINED INDICATES NEW FOR '96

REVISED: 1-29-96

1996 ORDER GUIDE

C/K 2500 CHASSIS-CAB

Page 1

Prices Shown Are Manufacturers Suggested Retail Prices (MSRP) At The Time Of Publication. These Prices Are To Be Used Only As An Aid To Inventory Management Since MSRP Figures Change Periodically. The Vehicle Price Schedule Is The Official Pricing Documentation Of Chevrolet Motor Division And Should Be Used In Discussing Vehicle Prices With Potential Buyers. The Model Prices Shown In The Order Guide Include The Destination Freight Charges.

**2500 CHASSIS CAB
TRIM DEFINITION & OPTION SUMMARY**

INTERIOR TRIM

		CHEYENNE	SILVERADO
AIR CONDITIONING:		O	S
ASSIST HANDLES:	PASSENGER	S	S
CONVENIENCE GP:	CRUISE CONTROL AND TILT WHEEL	O	S
	POWER WINDOWS, LOCKS	--	S
DOOR TRIM:	MOLDED PLASTIC W/ARMREST	S	--
	COLOR-KEYED CLOTH AND CARPET TRIM	--	S
FLOOR COVERING:	COLOR-KEYED RUBBER	S	O
	COLOR-KEYED CARPET	O	S
	RUBBER FLOOR MATS	O	S
HEADLINER:	COLOR-KEYED CLOTH	S	S
INSULATION:	ADDITIONAL SOUND-DEADENING	--	S
MAP POCKETS:	IN PASSENGER AND DRIVER'S DOOR	--	S
RADIO:	AM/FM STEREO W/SEEK-SCAN AND CLOCK	S	--
	AM/FM STEREO W/SEEK-SCAN, CLOCK AND CASSETTE TAPE	O	S
SEATING:	VINYL BENCH	S	S
STEERING WHEEL:	SIMULATED LEATHER	S	--
	LEATHER WRAPPED	--	S
STORAGE TRAY:	FULL WIDTH BEHIND SEAT	--	S
SUNSHADES	CLOTH COVERED W/LH STORAGE STRAP & W/RH MIRROR	S	S

EXTERIOR TRIM

		CHEYENNE	SILVERADO
BUMPER FRT:	CHROME	S	--
GRILLE:	MOLDED, PAINTED ARGENT	S	--
	CHROME DELUXE	O	S
HEADLAMPS:	SINGLE RECTANGULAR HALOGEN	S	--
	DUAL COMPOSITE - HALOGEN	O	S
HORN:	SINGLE NOTE	S	--
	DUAL NOTE	O	S
MIRRORS:	BREAK-A-WAY OSRV, BLACK	S	--
	ELECTRIC, REMOTE CONTROL, BLACK	--	S
NAMEPLATES:	CHEYENNE BADGE ON B-PILLAR	S	--
	SILVERADO BADGE ON B-PILLAR	--	S
PAINT:	SINGLE TONE	S	S
WHEELS:	SILVER PAINTED W/BLACK CENTER CAP	S	--
	RALLY WHEEL TRIM	O	S

BOLD, ITALICS AND UNDERLINED INDICATES NEW FOR '96

MODEL AND BODY

Description	Model No	Body	Wheel Base
2-WHEEL-DRIVE MODEL Chassis-Cab	CC20903	ZW9	131.5

*Includes Destination & Handling Charges

MODEL AND BODY

Description	Model No	Body	Wheel Base
4-WHEEL-DRIVE MODEL Chassis-Cab	CK20903	ZW9	131.5

EMISSIONS (Must Specify One) (Refer Emission Requirements Section)

- FE9 Federal Emission Requirements
- YF5 California Emission Requirements
- NG1 New York/Massachusetts Emission Requirements
- NB8 California or New York/Massachusetts Emission Override (Reqs FE9 Federal Emissions)
- NC7 Federal Emission Override (Reqs YF5 California or NG1 New York/Massachusetts Emissions)

*** GVWR SELECTOR (MUST SPECIFY GVW OPTION)**

Minimum Equipment Required for GVW Rating

GVW Option Required	GVW Rating (lbs)	GAWR*	
		Front	Rear
C20903			
C6P	8600	3600	6000
K20903			
C6P	8600	4250	6000

*GAWR's shown are the minimum for each axle with equipment listed. Other GAWR's are available, and they are determined as the minimum capacity of either axle, springs or tires.

CAPACITIES

C20903	
SPRINGS: Front 3600	AXLES: Front 3800
Rear 6084	Rear 6000

K20903	
SPRINGS: Front 3750	AXLES: Front 4250
Rear 6084	Rear 6000

POWER TEAMS (Must Specify Engine, Transmission and Rear Axle)

(Consult GVWR Selector For Minimum Equipment Required)

ENGINE	TRANSMISSION		AXLE		GVWR
	5-SP	AUTO	3.73	4.10	
CC20903					
L31 Vortec 5700 V8 H. D. (350 Cu In)--SFI	MW3	MT1	(a) GT4	(a) GT5	8600
L29 Vortec 7400 V8 H. D. (454 Cu In)--SFI	MW3	MT1	GT4	GT5	8600
L65 Turbo Diesel 6.5 Liter V8 H.D. (400 Cu In)	MW3	MT1	GT4	GT5	8600
CK20903					
L31 Vortec 5700 V8 H.D. (350 Cu In)--SFI	MW3	MT1	(a) GT4	(a) GT5	8600
L29 Vortec 7400 V8 H. D. (454 Cu In)--SFI	MW3	MT1	GT4	GT5	8600
L65 Turbo Diesel 6.5 Liter V8 H.D. (400 Cu In)	MW3	MT1	GT4	GT5	8600

a) N/A YF5 California Emissions

TIRES: Must Specify Front and Rear (Spare Tire Optional)

Description	All Seasons		On-Off Road		Spare
	Front	Rear	Front	Rear	
C20903					
TUBELESS Steel Belted Radial					
LT245/75R16-E B/W	XHH	YHH			ZHH
LT245/75R16-E B/W	XHH			YGK	ZGK
K20903					
TUBELESS Steel Belted Radial					
LT245/75R16-E B/W			XGK	YGK	ZGK
LT245/75R16-E B/W	XHH	YHH			ZHH

B/W = Blackwall

C/K 2500 CHASSIS-CAB

MUST SPECIFY:

AXLE, EMISSION, ENGINE, TIRES AND TRANSMISSION

No Deletions Allowed. Additional Options/Upgrades (Where Indicated) May be Ordered from the Custom Ordering Option Listing.

	CHEYENNE		SILVERADO	
	1 S M	1 S N	1 S R	1 S R
CHEYENNE DECOR	X	--		
Chassis Cab ZW9	X	X	X	
SILVERADO DECOR				YE9
Air Conditioning		X	X	
Radio AM/FM Stereo w/Cassette (A)		X	X	
Tilt and Cruise		X	X	
SILVERADO DECOR (Leather)				X
Keyless Entry				X
Mirror, ISRV				DD7
Trim, Leather Split Bench Seat				AE7

(A) May upgrade

REGULAR CAB MARKETING PACKAGES

Preferred Equipment Group Prices

1SM
PEG Savings
 w/1SM and R9A
 w/1SM w/o R9A

1SN or 1SR

CONVENIENCE PACKAGE

ORDERING OPTION=R9A
 (Reqs Peg 1SM)
 Incls :
 C60 Air Conditioning
 ZQ3 Tilt and Cruise
 UM6 Radio w/Cassette

**PEG Savings Amount represents the savings for Preferred Equipment Groups.

ADDITIONAL OPTIONS

INCL W/DECOR		OPTION
CHEV- ENNE	SILVER- ADO	
		ACKNOWLEDGEMENTS: R8S Multiple Order Numbers R8T Preliminary Invoice (Refer Vehicle Price Schedule for Prices) K47 AIR CLEANER: High Capacity (N/A Diesel Engine) C60 AIR CONDITIONING: (Incls R134A Refrigerant) w/1SN, 1SR or R9A w/1SM V22 APPEARANCE PACKAGE: (Incls Chrome Grille, Composite Halogen Headlamps and Dual Horns) w/1SN or 1SR w/1SM AXLES, REAR: (Refer Power Teams Chart for Availability) GU6 3.42 Ratio GT4 3.73 Ratio GT5 4.10 Ratio G80 Locking Differential TP2 BATTERY: Heavy-Duty, Auxiliary (N/A Diesel Eng) (Deletes Underhood Storage Box) ZW9 BODY: Chassis-Cab V10 COLD-CLIMATE PACKAGE: (Incls Eng Block Heater) (w/Diesel Eng Reqs Base Decor) X ZQ3 CONVENIENCE GROUP: Tilt-Wheel and Speed Control w/1SN, 1SR or R9A w/1SM EMISSIONS: (Refer Emission Requirement Tab Section) FE9 Federal Emission Requirements YF5 California Emission Requirements NG1 New York/Massachusetts Emission Requirements NB8 California or New York/Massachusetts Emission Override (Reqs FE9 Federal Emissions) NC7 Federal Emission Override (Reqs YF5 California or NG1 New York/Massachusetts Emissions) ENGINES: (Refer Power Teams Chart for Availability) L31 Vortec 5700 V8 (350 Cu In)--SFI L65 6.5 Liter V8 H.D. Turbo Diesel (400 Cu In) (Incls Bumper Guards) (Deletes Underhood Storage Box) KL5 Alternative Fuel (LPG or CNG Conversion Ready) (Reqs L31 Eng and Auto Trans) FLOOR COVERING: BG9 Full Floor, Rubber, Color-Keyed (Replaces Carpeting and Floor Mats) B30 Carpet Floor Covering B32 Floor Mats (Reqs B30 Floor Covering) GVWR: (Must Specify) (Refer GVWR Selector Chart for Availability) C6P 8600# N/A AU0 KEYLESS ENTRY: Remote U01 LAMPS: Roof Marker (N/A YF5 Calif Emissions) VK3 LICENSE PLATE BRACKET: Front N/A AU3 LOCKS: Power Door MIRRORS: DF2 Camper Type, Stainless Steel, 7.5" W x 10.5" H, Exterior w/1SN or 1SR w/1SM DG5 Senior West Coast, LH and RH Stainless Steel, 7" W x 16" H, Exterior w/1SN or 1SR w/1SM N/A DD7 10" Electrochromic ISRV with 8 Point Compass, Interior w/1SR w/1SN PAINT, EXTERIOR: (Refer Color and Trim Chart for Availability) ZY1 Solid RADIO EQUIPMENT: X UM6 Electronically Tuned AM/FM Stereo Radio w/Seek-Scan, Stereo Cassette Tape and Digital Clock w/1SN, 1SR or R9A w/1SM N/A UL0 Electronically Tuned AM/FM Stereo Radio w/Seek-Scan w/Automatic Tone Control, Digital Clock Cassette Tape, Theft Lock and Speed Compensated Volume (Incls Enhanced Performance Speaker System)

ADDITIONAL OPTIONS

INCL W/DECOR		OPTION	DESCRIPTION
CHEV- ENNE	SILVER- ADO		
N/A		UN0	RADIO EQUIPMENT: (Continued) Electronically Tuned AM/FM Stereo Radio w/Seek-Scan w/Automatic Tone Control, Compact Disc Player, Digital Clock, Theft Lock and Speed Compensated Volume (Incls Enhanced Performance Speaker System)
N/A		UP0	Electronically Tuned AM/FM Stereo Radio w/Seek-Scan w/Automatic Tone Control, Compact Disc Player, Digital Clock, Cassette Tape, Theft Lock and Speed Compensated Volume (Incls Enhanced Performance Speaker System) (Reqs MT1 Trans)
	N/A	UL5	Radio Delete
			SEAT TYPE: (Refer Color/Trim Chart for Availability)
		A52	Bench Seat (Incls Storage Armrest and Power Lumbar w/Custom Cloth or Leather Trim) w/1SM or with 1SN w/o Leather w/1SN with Leather
		AE7	Reclining Split Bench Seat (Incls Storage Armrest and Power Lumbar w/Custom Cloth or Leather Trim) w/1SR w/1SM or with 1SN w/o Leather w/1SN with Leather
		A95	Reclining High Back Bucket Seats (Incls Power Lumbar) w/1SR w/1SN without Leather w/1SN with Leather
		NZZ	SKID PLATE: Off-Road (K2500 Only)
		VYU	SNOW PLOW PREP PACKAGE: (K20903 Only) (Incls F60 HD Front Springs)
		F60	SPRINGS, FRONT: Heavy Duty (K2500 Only) (Incl w/VYU Snow Plow) w/VYU w/o VYU
			TIRES: (Refer Tire Chart for Availability; Vehicle Price Schedule for Prices)
		V76	TOW HOOKS: Two Front (Standard on K2500 Models)
		NP1	TRANSFER CASE: Electronic Shift Control, 2-Speed (Reqs 4-Wheel Drive and Auto Trans) (Reqs ZQ3 Convenience Package or Silverado Decor)
			TRANSMISSIONS: (Refer Power Teams Chart for Availability)
		MW3	5-Speed Manual with Deep Low and Overdrive, Heavy-Duty
		MT1	4-Speed Electronically Controlled Automatic with Overdrive, Heavy-Duty
	x	P06	WHEEL TRIM: Rally Wheel w/1SN or 1SR w/1SM
		A28	WINDOWS: Sliding Rear

C/K 2500 CHASSIS-CAB INTERIOR AND EXTERIOR COLOR AVAILABILITY CHART WITH ZY1 PAINT SCHEMES

PLEASE NOTE: Below are the interior trim color and exterior paint combinations recommended by Chevrolet. They are the only available interior and exterior combinations allowed.

TRIM LEVEL (Must Specify Seat Option and Interior Color) Seat Type	SEAT OPT	INTERIOR COLORS					
		Neutral	Blue	Gray	Red		
CHEYENNE (STD DECOR)							
Vinyl Bench Seat	A52	52V	26V	13V	79V		
Cloth Bench Seat	A52	52C	26C	13C	79C		
SILVERADO DECOR							
Vinyl Bench Seat	A52	52V	26V	13V	79V		
Custom Cloth Bench Seat	A52	52D	26D	13D	79D		
* Custom Leather Bench Seat	A52	522	262	132	792		
Custom Cloth Reclining Split Bench Seat	AE7	52D	26D	13D	79D		
* Custom Leather Reclining Split Bench Seat	AE7	522	262	132	792		
Custom Cloth Reclining High Back Bkt Seats	A95	52D	26D	13D	79D		
EXTERIOR COLORS	Color Code	PAINT SCHEME	INTERIOR & EXTERIOR COMBINATIONS SHOWN ARE THE ONLY COMBINATIONS AVAILABLE				K2500 Wheel Flare Color
AUTUMNWOOD LT (Metallic)	55U	ZY1	x				Autumnwood, Lt.
BLACK, ONYX	41U	ZY1	x		x	x	Black
BLUE, INDIGO (Metallic)	39U	ZY1	x	x	x		Indigo
BLUE, LT (Metallic)	27U	ZY1		x	x		Dk Argent
GREEN, EMERALD (Metallic)	43U	ZY1	x		x		Dk Argent
GREEN, TEAL (Metallic)	38U	ZY1	x		x		Dk Argent
QUICKSILVER (Metallic)	96U	ZY1		x	x	x	Silver
RED, DK GARNET (Metallic)	84U	ZY1	x		x	x	Red, Dk Garnet
RED, VICTORY	74U	ZY1	x		x	x	Dk Argent
WHITE, SUMMIT	50U	ZY1	x	x	x	x	Dk Argent

* Leather on Seating Surface Only

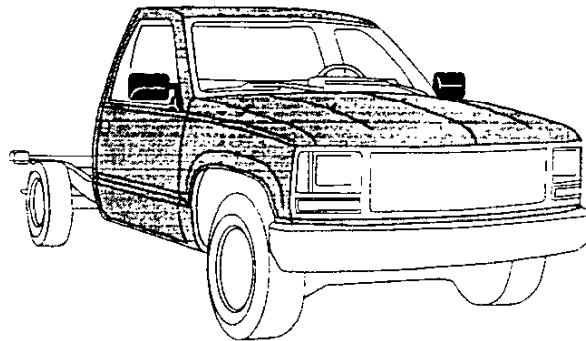

SOLID PAINT - ZY1

1996 GENERAL MOTORS CORPORATION

INFORMATION REGARDING

CONSUMER INFORMATION TRUCK-CAMPER LOADING

REVISED SEPTEMBER 1995



CHEVROLET MOTOR DIVISION
30007 VAN DYKE AVENUE
WARREN, MICHIGAN 48090



GMC TRUCK DIVISION
31 JUDSON STREET
PONTIAC, MICHIGAN 48342-2230

1996 GENERAL MOTORS TRUCKS

Consumer Information

Truck - Camper Loading

CONSUMER INFORMATION REGULATION 575.103 issued by the National Highway Traffic Safety Administration requires manufacturers of trucks capable of accommodating slide-in camper bodies to provide information concerning proper load and proper load distribution in truck-camper applications.

This Consumer Information booklet is designed to provide basic information relating to load capabilities of 1996 General Motors truck models which are adaptable to slide-in camper applications. Information contained herein is applicable to the truck buyer who already owns a 1996 General Motors truck or to a prospective truck purchaser.

The regulation also provides that proper truck-camper loading information is to be maintained in truck dealerships and be made available to all prospects on request. This booklet relates to the 1996 General Motors truck models recommended for slide-in camper applications and is to be used as a consumer information brochure.

Product specifications or data contained herein may change periodically. When a revision of this booklet is supplied to truck dealers, it is the dealers' responsibility to make the revised information available to the public.

Chevrolet's and GMC's 1988 and newer Full-Size C/K Pickups feature a styling that is more aerodynamic than prior models. Aftermarket manufacturers offer many products, such as slide-in campers, camper shells, and bedliners, designed to fit on the new pickups. However, some products designed for use on Chevrolet Full-Size Pickups, built prior to the 1988 model year or R-V models through the 1991 model year, may not fit in the bed of this vehicle. Please confirm the compatibility of any aftermarket product you intend to install on your new truck by consulting the product manufacturer.

Chevrolet's and GMC's 1994-1996 S/T Series Pickups feature new styling that is more aerodynamic than models from previous years. Some aftermarket items designed for 1993 and earlier S/T Series Pickups may not fit in the bed of this new vehicle. Please consult the product manufacturer for compatibility prior to purchase.

All illustrations and specifications contained in this literature are based on the latest product information available at the time of publication approval. The right is reserved to make changes at any time in prices, colors, materials, equipment, specifications and models, and also to discontinue models.

TRUCK-CAMPER LOADING

Consumer Information Regulation 575.103 requires manufacturers of trucks capable of accommodating slide-in campers to specify the vehicles' Cargo Weight Rating (CWR) and the longitudinal limits within which the center of gravity for the cargo weight rating should be located.

Cargo Weight Rating (CWR)—The cargo weight rating of a vehicle means the value specified by the vehicle manufacturer as the cargo-carrying capacity of a vehicle in pounds, exclusive of (minus) the weight of occupants, computed as 150 pounds times the number of designated seating positions.

Longitudinal Center of Gravity (CG) Zone for CWR—The forward limit of the recommended CG Zone is determined by the application of dimension "A" measured in inches from the rear of the truck bed. The rearward limit of the recommended CG Zone is established by application of dimensions "B", also measured in inches from the rear of the truck bed. The recommended CG Zone lies between these points.

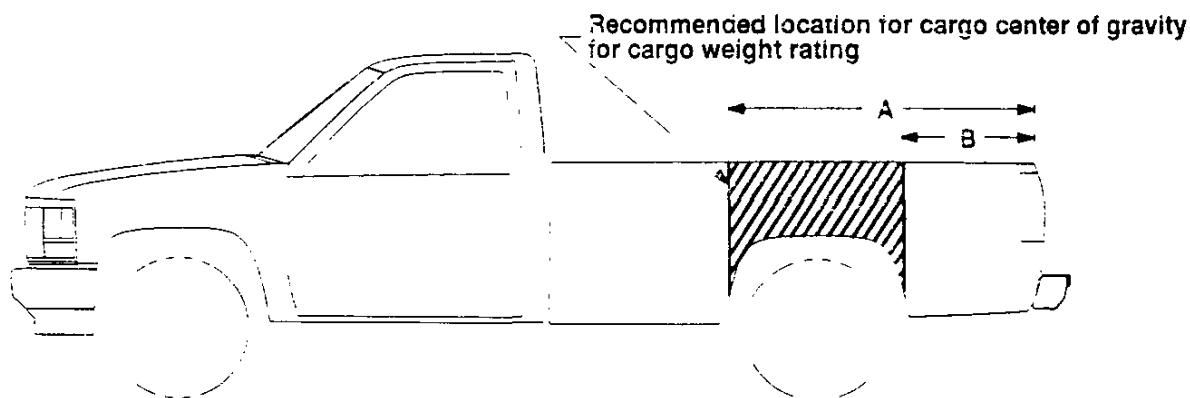

Model _____ Calculated Cargo Weight Rating _____

Dimension A _____ Dimension B _____

Limitations on Recommended CG Zones

FORWARD LIMIT

- (1) Must not extend beyond the inside surface of the pickup box.
- (2) Must not exceed the front gross axle weight rating (GAWR).

REARWARD LIMIT

- (1) Must be no farther rearward than the inside surface of the pickup box.
- (2) Must not exceed the gross axle weight rating (GAWR) of the rear axle.
- (3) Must not exceed rear axle load limits below:

Series	Rear Axle Load Limits (% of GVWR)
S/T 10/Sonoma 2WD 4600 lb. GVWR 2WD 4900 lb. GVWR 4WD 5150 lb. GVWR	63% 59% 57%
C/K 1500	60%
C/K 2500	65%
C/K 2500/C6P, C/K 3500	70%

Vehicle CG Identification—All General Motors Corporation trucks that may be suitable for carrying a slide-in camper incorporate a Truck-Camper Loading information label located on the glove box floor on C/K and S/T 10/Sonoma models. The vehicle identification number (VIN), the as-manufactured cargo weight rating (CWR) of that vehicle plus the CG limits of dimension "A" and "B" for that vehicle in inches are included.

Vehicle and Truck-Camper Loading are also discussed at length in the Vehicle Owner's Manual.

TRUCK-CAMPER LOADING

Loading Instructions—When the truck is used to carry a slide-in camper, the total cargo load of the truck consists of the manufacturer's camper weight figure, the weight of installed additional camper equipment not included in the camper manufacturer's weight figure, the weight of camper cargo and the weight of passengers *in the camper*. The total cargo load should not exceed the truck's cargo weight rating (CWR) and the camper's center of gravity should fall within the truck's recommended center of gravity zone when installed.

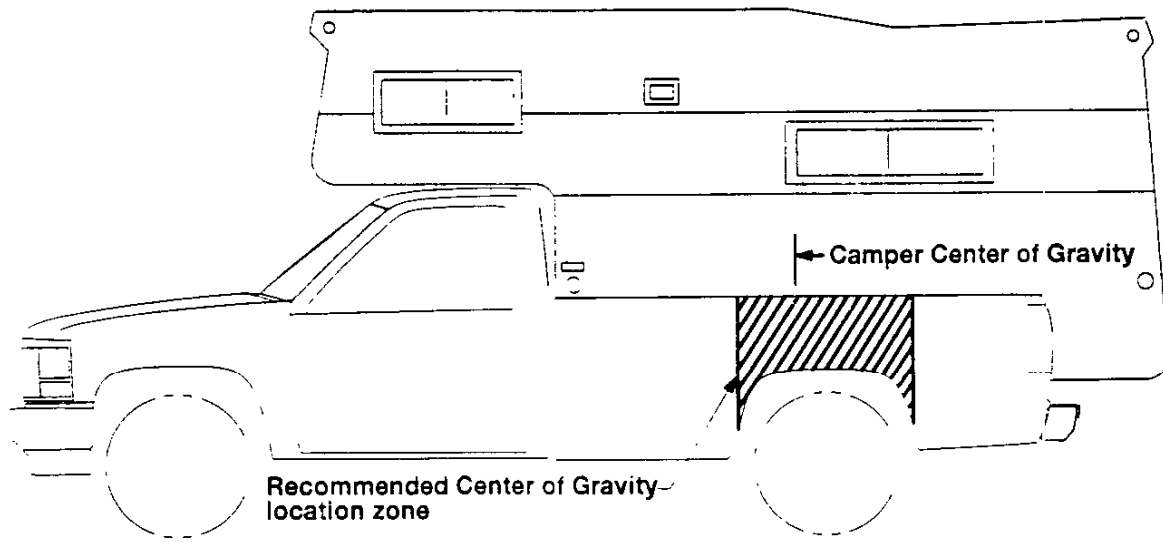

Any accessories or other equipment added to this vehicle, after final date of manufacture, must be weighed or have their weight determined, and the weight deducted from the prescribed cargo weight rating (CWR) of this vehicle. This may decrease the permissible longitudinal zone of the center of gravity for this vehicle.

The longitudinal center of gravity zone has been determined for the full cargo weight rating of this truck. If a slide-in camper has a total weight less than the cargo weight rating (CWR), the permissible longitudinal zone of the center of gravity may be larger. However, individual axle loads should not exceed either of the gross axle weight ratings (GAWR).

Secure loose items to prevent weight shifts that could affect the balance of your vehicle. When the truck camper is loaded, drive to a scale and weigh on the front and on the rear separately to determine the axle loads. Individual axle loads should not exceed either of the gross axle weight ratings (GAWR). The total of the axle loads should not exceed the gross vehicle weight rating (GVWR). These ratings are given on the vehicle identification plate and on the vehicle certification label which are located on the left side of the vehicle, normally on the door latch post or door edge next to the driver. If weight ratings are exceeded, move or remove items to bring all weights below the ratings.

CAUTION: The longitudinal center of gravity is only one of the many factors which may affect the overall performance of a vehicle, including handling, steering and braking. The cargo load should be distributed on both sides of the centerline as equally as possible. The recommended longitudinal limits for the camper's center of gravity are based on the assumption that the vehicle will be operated with reasonable prudence in light of all of the existing conditions. Failure to do so could result in unsatisfactory vehicle performance and could make the vehicle unsafe to operate.

In this connection, refer to any recommendations by the slide-in camper manufacturer regarding installation and loading of the camper.

TRUCK-CAMPER LOADING

DEFINITION OF TERMS

For the purposes of calculating Truck-Camper Loading in this book, listed below are some common terms and abbreviations:

Cargo Weight Rating (CWR)— means the value specified by the vehicle manufacturer as the cargo-carrying capacity of a vehicle in pounds, exclusive of (minus) the weight of occupants, computed as 150 pounds times the number of designated seating positions.

Center of Gravity (CG)—point where the mass of a body is concentrated and if suspended at that point would balance front and rear.

Curb Weight—weight of a vehicle without driver, passengers or cargo but including maximum capacity of fuel, oil, coolant and other items of standard equipment.

Dimension A & B—front and rear limit of Center of Gravity (CG) zone.

Gross Vehicle Weight Rating or 'GVWR' means the value specified by the manufacturer as the loaded weight of a single vehicle.

Gross Axle Weight Rating or 'GAWR' means the value specified by the vehicle manufacturer as the load carrying capacity of a single axle system measured at the tire-ground interfaces.

Model Weight—weight of the vehicle with all items of standard equipment, 150 pounds per passenger in each designated seating position and maximum capacity of fuel, oil and coolant.

Payload Rating is the maximum allowable load (including the weight of the driver and all occupants) that the vehicle can carry based on all factory-installed equipment on the vehicle.

RPO—Regular Production Option.

Slide-In Camper—means a camper having a roof, floor, and sides, designed to be mounted on and removable from the cargo area of a truck by the user.

Weight Distribution—the amount of a vehicle's weight that rests on each axle.

Wheelbase (WB)—the distance from the centerline of the front axle to the centerline of the rear axle.

LIMITATIONS

The following General Motors truck models are not recommended for slide-in camper applications:

- Any pickup model with a cargo weight rating (CWR) of less than 500 lbs. A statement to this effect is imprinted on the Truck-Camper Loading information label which states whether that vehicle is recommended for use with a slide-in camper.
- S 10/Sonoma (2WD) Pickup with 4200 lb. GVWR.
- T 10/Sonoma (4x4) Pickup.
- S/T 10/Sonoma Pickup with 108.3" WB.
- S/T 10/Sonoma Extended Cab Pickup.

Note: C/K 1500 Pickups should not be used for larger, cab-over type slide-in campers.

TRUCK-CAMPER LOADING

S/T PICKUPS, C/K PICKUPS, EXTENDED/CLUB AND CREW CAB PICKUPS

INSTRUCTIONS FOR PROSPECTIVE TRUCK PURCHASERS VEHICLE SELECTION AND WEIGHT ANALYSIS

1. For S 10/Sonoma Models.

You must order S 10803 (117.9" WB) model with one of the following GVWR Ratings:

S 10803 (2WD)	4600 lb. GVWR	Option C5D
S 10803 (2WD)	4900 lb. GVWR	Option C5A

if you intend to use a slide-in camper on your S 10/Sonoma Pickup. Record the model on page 3. Record the model GVWR, front GAWR, and rear GAWR on page 7. These ratings can be found in the S 10/Sonoma section of the General Motors Light-Duty Truck Data Book or Chevrolet Light-Duty Technical Guide on the Specifications pages. This information is also available in the Chevrolet Spec Manager computer program.

For C/K Models

From the model selection pages of the C/K pickup section of the GMC Light-Duty Truck Data Book, Chevrolet Light-Duty Technical Guide or the Chevrolet Spec Manager System, select the pickup model you desire. Record this information on page 3. Refer to the Specification section for the selected model. Select the GVWR you require and note any minimum tire size and chassis equipment requirements for that GVWR. (To approximate the GVWR you require, add your loaded camper weight to the vehicle curb weight plus the occupants weight at 150 lbs. per designated seating position.) Record the GVWR and the Gross Axle Weight Rating (GAWR), Front and Rear (from the Specifications section), on line 1 of the camper loading worksheet, page 7.

- Record the front and rear curb weights of your selected vehicle on line 2, page 7.
- Record the front and rear passenger weights on line 3, page 7.
- List all factory-installed options you desire, including any options required by your selected GVWR, with their front and rear weights on the Pickup camper loading worksheet on page 7.
- Total the front and rear weights of vehicle model and options to arrive at the total front and rear weight of the vehicle. Follow the directions on page 7, lines 5 through 5C to arrive at the adjusted total vehicle weight.
- Subtract the adjusted total vehicle weight from the GVWR to arrive at the cargo weight rating (CWR) of your truck.* Record this information on page 3.
- Proceed to page 11 and calculate the center of gravity location limits using front and rear GAWRs, cargo weight rating (CWR), and front and rear weight of truck as determined above. Record this information on page 3.

*The addition of any dealer-installed or other accessories will reduce the cargo-carrying capacity by the weight of the equipment installed.

TRUCK-CAMPER LOADING S PICKUPS, C/K PICKUPS

WORKSHEET-CARGO WEIGHT RATING

1. Model GVWR _____ GAWR FRONT _____ REAR _____

2. Curb Weights: FRONT _____ REAR _____

3. Passenger Weights: FRONT _____ REAR _____

4. Other factory-installed options:

4a. TOTALS _____

5. Front and Rear Weights _____

5a. Vehicle sub-total weight (add front and rear weight) _____

5b. Add 50 lbs. for all models* +50.0

5c. Adjusted total vehicle weight: _____

6. Vehicle GVWR: _____

Adjusted total vehicle weight (- _____)

Cargo Weight Rating _____

Record on page 3.

* If your vehicle is available, drive to a scale and weigh, with occupants, full fuel tank, and other factory-installed options to determine the adjusted total vehicle weight. You will then be able to use your actual total vehicle weight and not have to add the 50#.

TRUCK-CAMPER LOADING DIMENSIONS

S PICKUP

S 10/SONOMA

Long Box (Model S 10803)

	A	B	C	D	E	F	G	H	J	K
Long Box	52.00	40.35	67.91	68.81	36.25	93.3	88.3	56.61	57.6	56.61

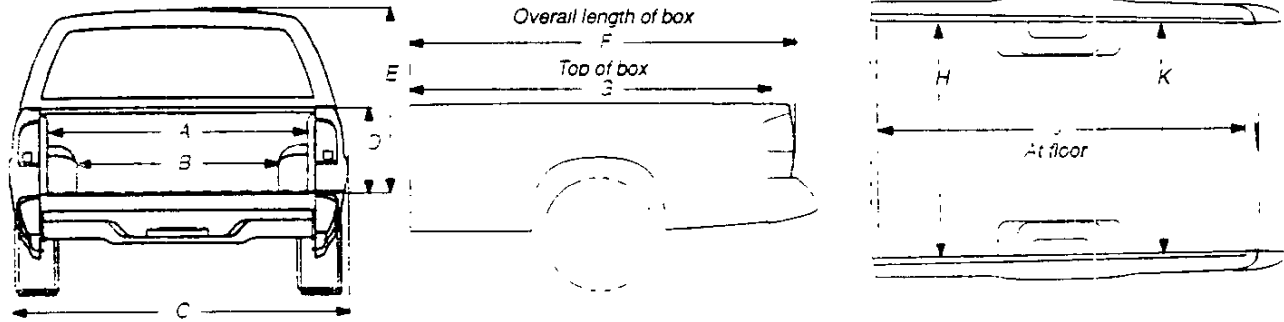

C/K PICKUPS

FLEETSIDE/WIDESIDE

Short Box (Models C/K 10703, 10753, 20753)

Long Box (Models C/K 10903, 10953, 20903, 20953, 30903, 30943, 30953)

	A	B	C	D	E	F	G	H	J	K
Short Box	60.24	49.06	76.75	94.3	19.29	41.44	82.48	63.78	78.56	61.89
Long Box	60.24	49.06	76.75	94.3	19.29	41.44	101.38	63.78	97.56	61.89

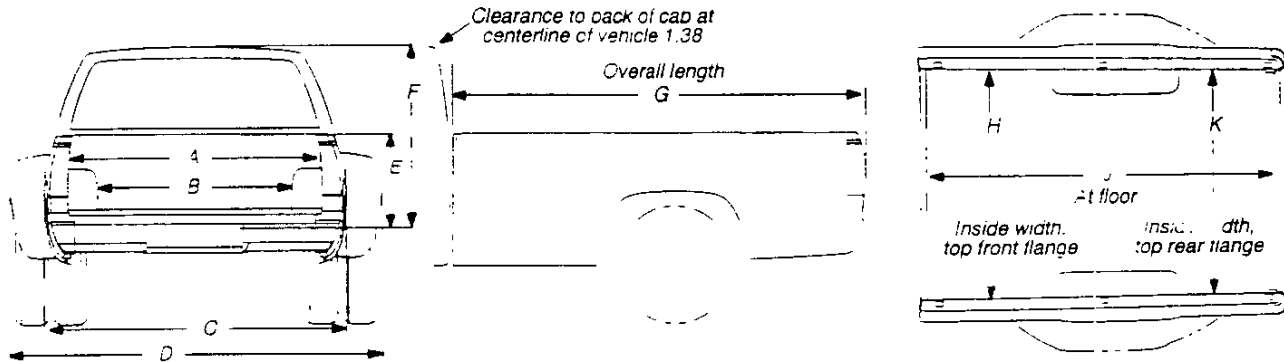

SPORTSIDE Short Box (Model C/K 10703, 10753&E62)

	A	E	G	D	E	F	G	H	J
Short Box	49.13	49.13	77.12	92.29	41.44	32.29	49.13	76.7	49.13

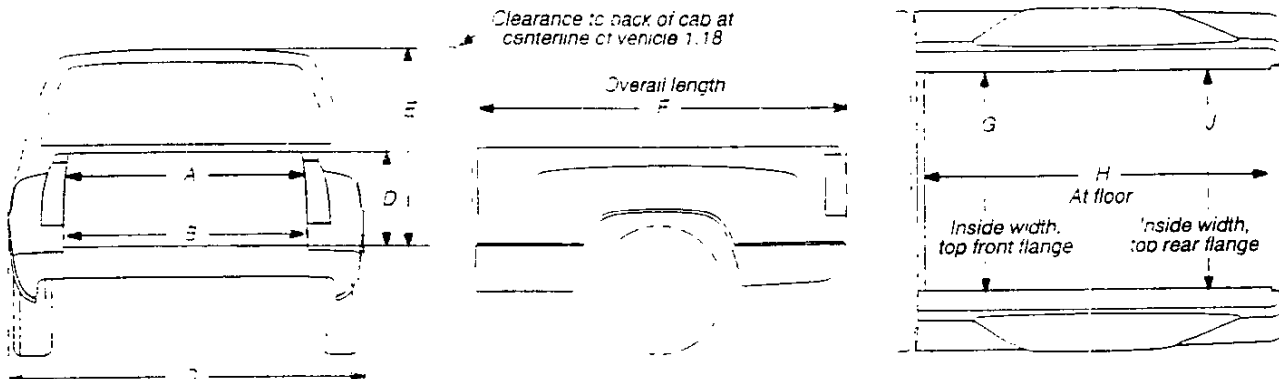

TRUCK-CAMPER LOADING DIMENSIONS

C/K PICKUPS

STANDARD CAB PICKUPS

Short Box (Models C/K 10703)

Long Box (Model C/K 10903, 20903, 30903)

	A	B	C	D	E	F
Short Box	111.0	77.2	35.4	117.5	47.3	200.2
Long Box	111.0	96.1	35.4	131.5	52.2	219.1

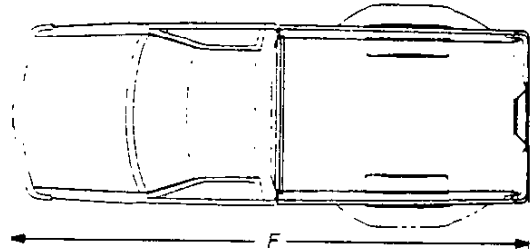
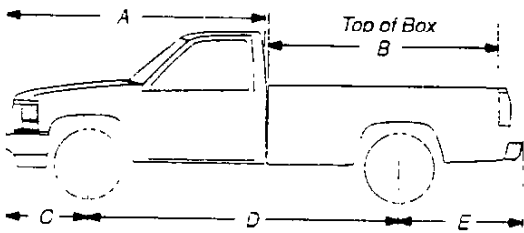

EXTENDED CAB PICKUPS

Short Box (Model C/K 10753, 20753)

Long Box (Model C/K 10953, 20953, 30953)

	A	B	C	D	E	F
Short Box	135.0	77.2	35.4	141.5	47.3	224.2
Long Box	135.0	96.1	35.4	155.5	52.2	243.1

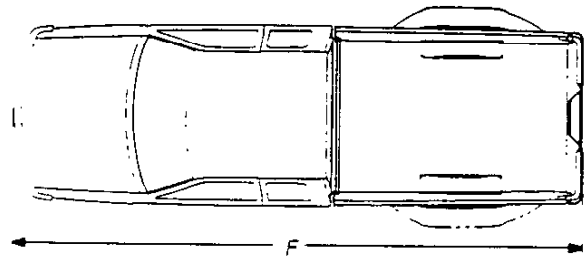
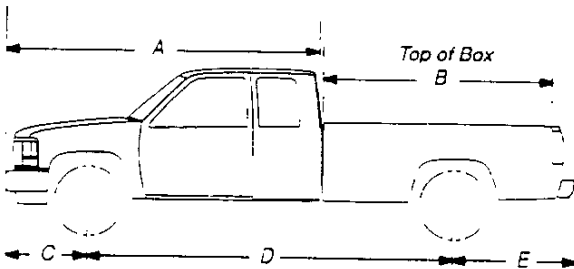

CREW CAB PICKUPS

Long Box (Model C/K 30943)

	A	B	C	D	E	F
Long Box	148.5	96.1	35.9	168.5	52.2	256.6

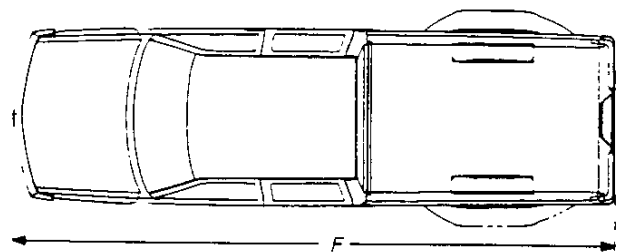
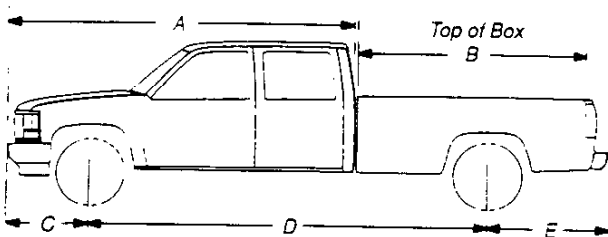

TRUCK-CAMPER LOADING

MODEL CODES AND DIMENSIONS

SERIES	MODEL NUMBER	PICKUP BOX LENGTH	PICKUP STYLE	WB	"C"
--------	--------------	-------------------	--------------	----	-----

REGULAR CAB MODELS

S 10/ Sonoma	S 10803	7.4'	Fleetside/Wideside (E63)	117.9"	42.90"
C/K 1500	C/K 10703	6.5'	Fleetside/Wideside (E63) Sportside (E62)	117.5" 117.5"	38.53" 38.48"
	C/K 10903	8'	Fleetside/Wideside (E63)	131.5"	43.46"
C/K 2500	C/K 20903	8'	Fleetside/Wideside (E63)	131.5"	43.46"
C/K 3500	C/K 30903	8'	Fleetside/Wideside (E63)	131.5"	43.46"

EXTENDED/CLUB CAB MODELS

C/K 1500	C/K 10753	6.5'	Fleetside/Wideside (E63) Sportside (E62)	141.5" 141.5"	38.53" 38.48"
	C/K 10953	8'	Fleetside/Wideside (E63)	155.5"	43.46"
C/K 2500	C/K 20753	6.5'	Fleetside/Wideside (E63)	141.5"	38.53"
	C/K 20953	8'	Fleetside/Wideside (E63)	155.5"	43.46"
C/K 3500	C/K 30953	8'	Fleetside/Wideside (E63)	155.5"	43.46"

CREW CAB MODELS

C/K 3500	C/K 30943	8'	Fleetside/Wideside (E63)	168.5"	43.46"
----------	-----------	----	--------------------------	--------	--------

Dimension "C" is the distance from the centerline of the rear axle to the end of the pickup box floor.
Dimension A and B can be calculated by using the formula on page 11.

REGULAR CAB S 10/SONOMA PICKUPS

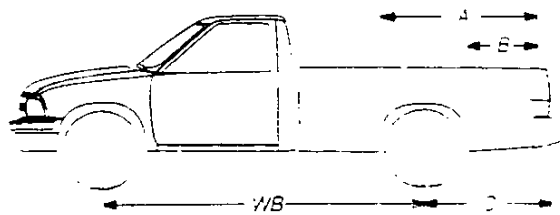

EXTENDED CAB C/K PICKUPS

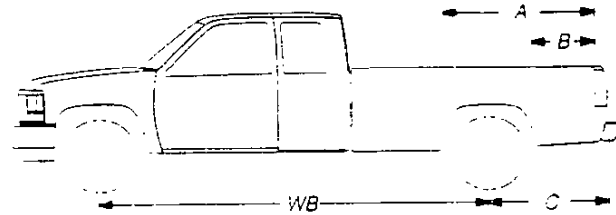

REGULAR CAB C/K PICKUPS

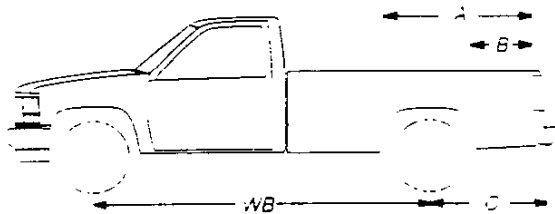

CREW CAB PICKUPS

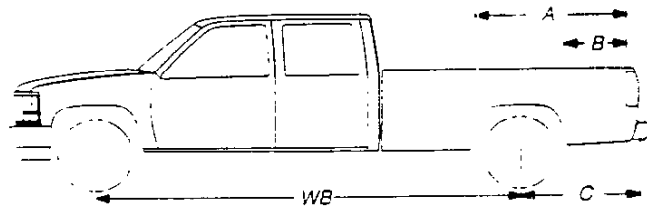

TRUCK-CAMPER LOADING

CALCULATIONS TO DETERMINE FORWARD (A) AND REARWARD (B) LOCATION OF CENTER OF GRAVITY FOR CARGO WEIGHT RATING

Calculations for Dimension A

$$A = \left\{ \frac{\text{Front GAWR} - 1.05 \times \text{Front Weight}^* \text{ of Truck}}{\text{Cargo Weight Rating}} \right\} \times \text{WB} + C$$

Enter Front GAWR			
Subtract Front Weight* of Truck x 1.05	-		
Answer			
Divide Answer by Cargo Weight Rating (CWR)	÷		
Answer			
Multiply Answer by Wheelbase (See Chart on page 10)	X		
Answer			
Add C Dimension to Answer (See Chart on page 10)	+C		
Dimension A	=		

Note: If "A" is greater than pickup box length, use box length for "A" dimension.

Calculations for Dimension B

$$B = \left\{ 1 - \frac{\text{Rear GAWR} - 1.1 \times \text{Rear Weight}^* \text{ of Truck}}{\text{Cargo Weight Rating}} \right\} \times \text{WB} + C$$

Enter Rear GAWR			
Subtract Rear Weight* of Truck x 1.1	-		
Answer			
Divide Answer by Cargo Weight Rating (CWR)	÷		
Answer			
Subtract Answer from 1.000	-		
Multiply Answer by Wheelbase (See Chart on page 10)	X		
Answer			
Add C Dimension to Answer (See Chart on page 10)	+C		
Dimension B	=		

Note: If "B" dimension is negative, use 0 (zero) for "B" dimension.

If "B" dimension is greater than "A" dimension, camper usage is not recommended at the Calculated Cargo Weight Rating. Camper usage may be possible for a lighter camper. Substitute known specific camper weight (less than Cargo Weight Rating) for Cargo Weight Rating in calculations above to determine "A" to "B" range for that specific camper.

Record dimension A and B on page 3.

Front page 7 line 4a.



CHEVROLET MOTOR DIVISION
30007 VAN DYKE AVENUE
WARREN, MICHIGAN 48090



GMC TRUCK DIVISION
31 JUDSON STREET
PONTIAC, MICHIGAN 48342-2230