

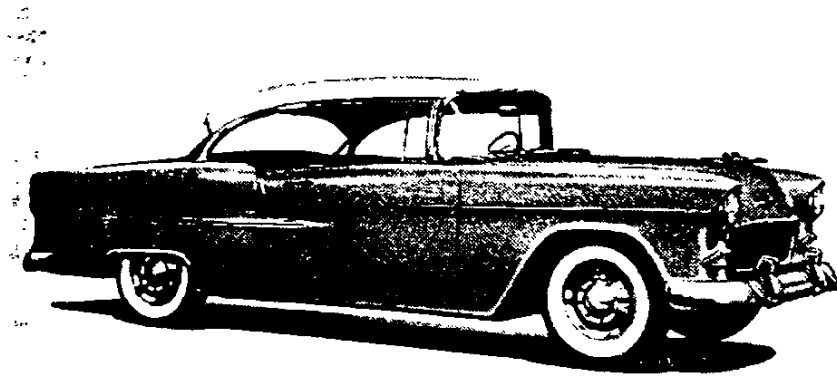

CHEVROLET



1955 Chevrolet. Bel Air two-door hardtop Sport Coupe. V-8

1955

CHEVROLET

1955

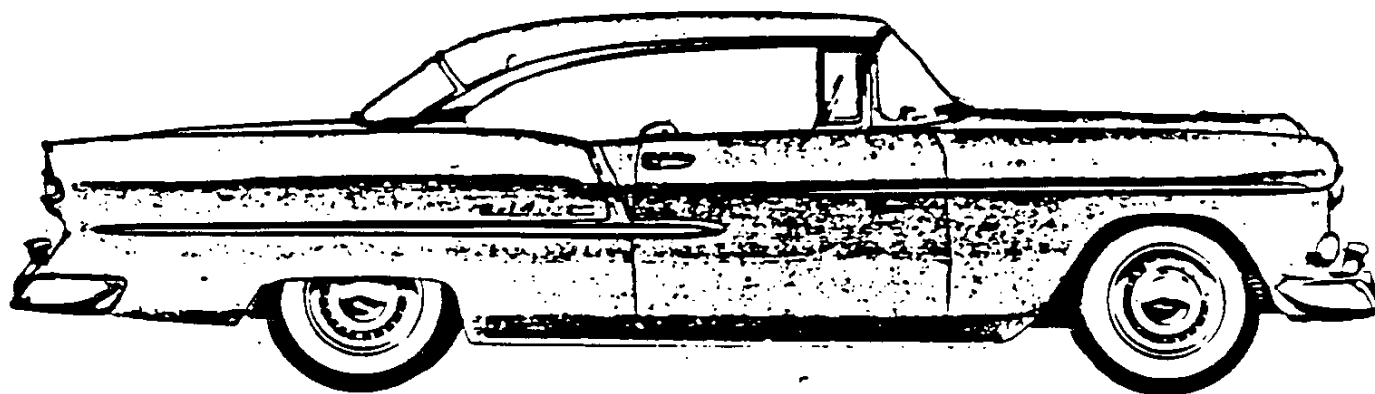

New Look! New Life (V8 OR 6)! New Everything!

BEL AIR SERIES

2-door Sedan
4-door Sedan
Sport Coupe
Convertible
4-door station wagon
Nomad

TWO-TEN SERIES

2-door Sedan
4-door Sedan
Del Ray Club Coupe
2-door station wagon
4-door station wagon

ONE-FIFTY SERIES

2-door Sedan
4-door Sedan
Utility Sedan
2-door station wagon

1955

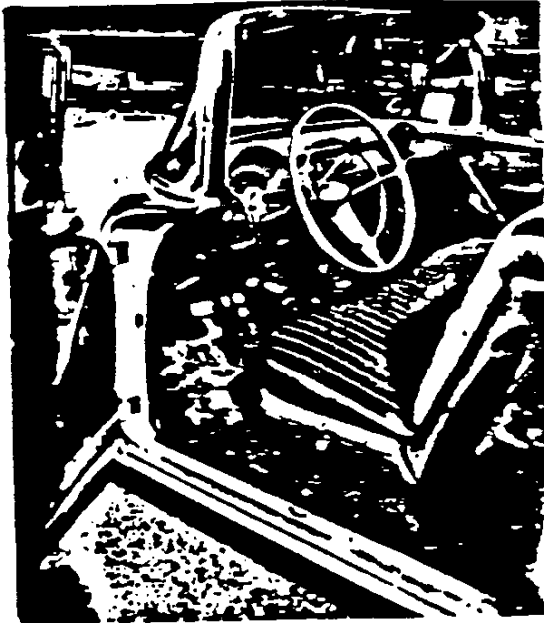

The front seats of all models are adjustable and move in an inclined track which raises seat as it moves forward. A power-operated seat is available as an option, or seat may be manually adjusted by releasing knob (left).

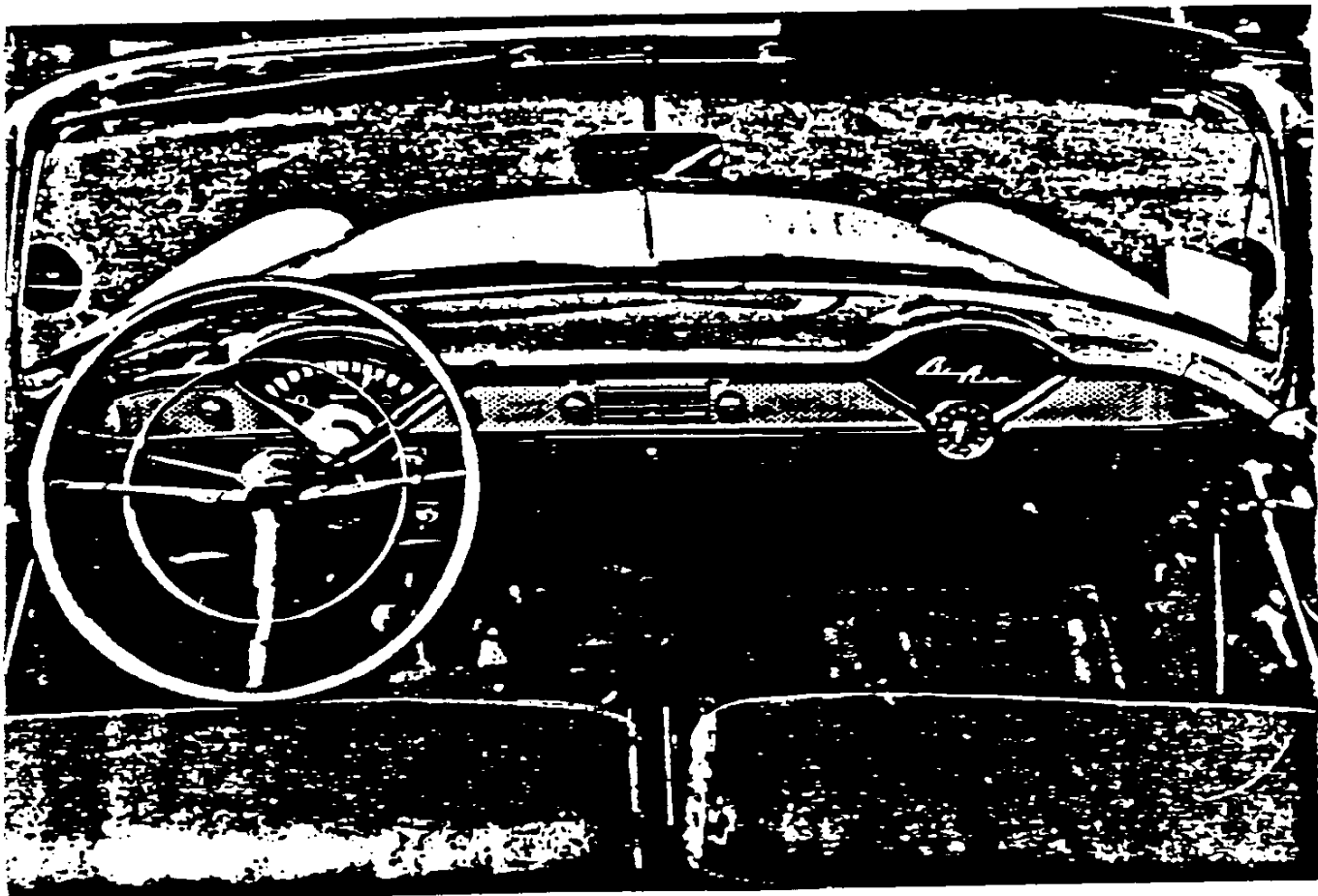

Interior view, 1955 Bel Air Convertible

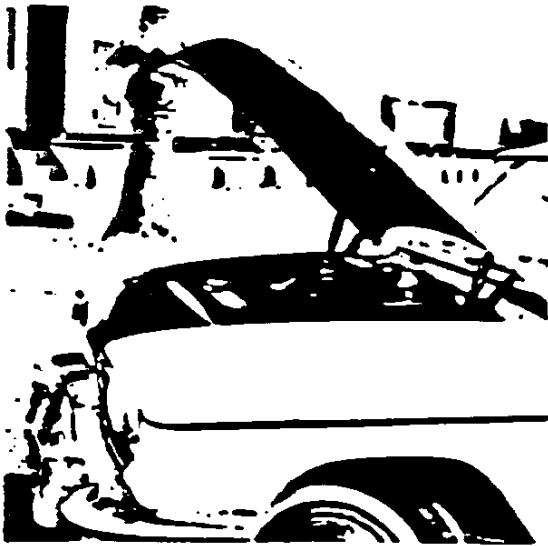

Hoods are front-opening on all models.

A factory-installed option, the new Plus-Power Package boosts the standard V-8 horsepower from 162 to 180 with dual exhausts, four-barrel carburetor, etc.

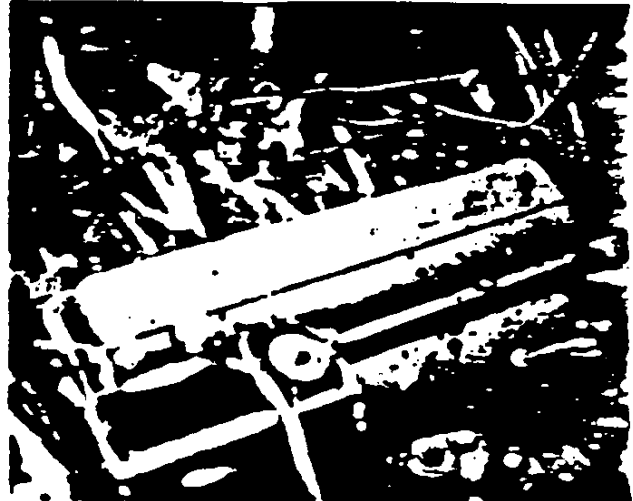

Two steel valve covers bearing the Chevrolet name are used on the new V-8 engines.



Running from the rear left corner of the V-8 manifold is a semi-flexible copper tube connected to a temperature sensing probe. Used only on the 1955 V-8, the "mechanical" manifold was modified in 1956 to accept an electrical sensor and the copper tube deleted.

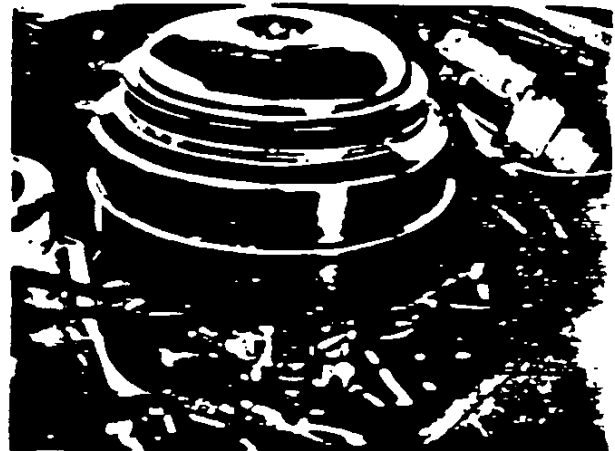

A new oil-bath air cleaner is employed on the new V-8.

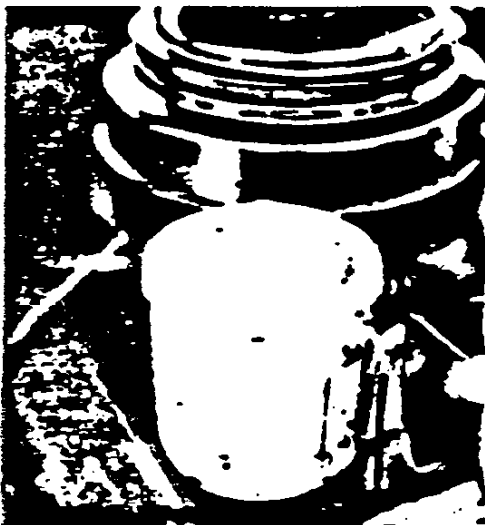

This is a factory accessory oil filter. The 1955 lock had no other provision for filtering the

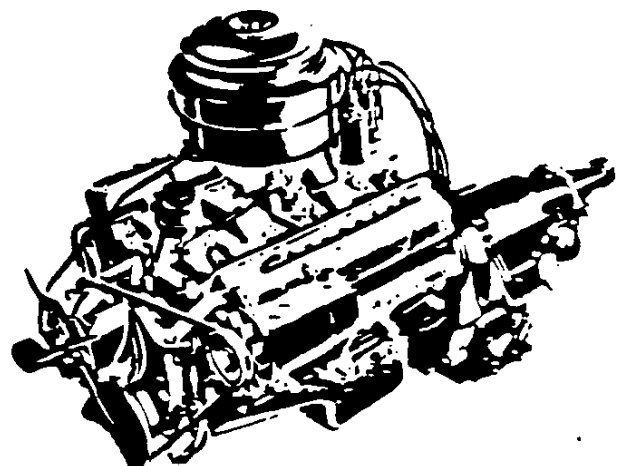

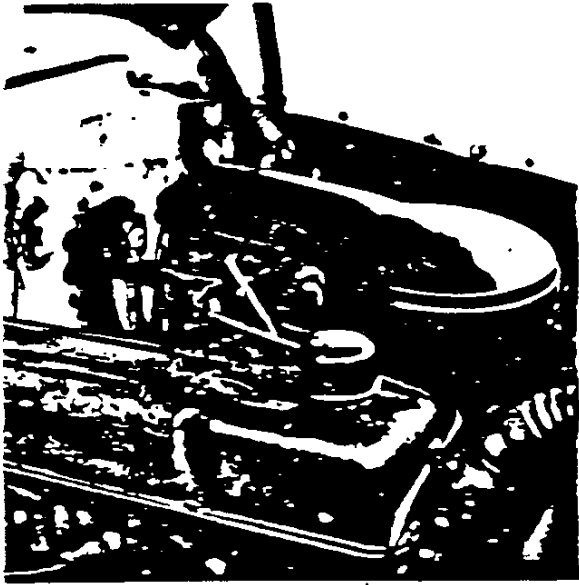

Two Sixes are available. The standard engine, with Synchro-Mesh transmission, is rated at 123 horsepower. The Powerglide version with the high-lift cam, hydraulic lifters, and other changes, is rated at 136 hp.

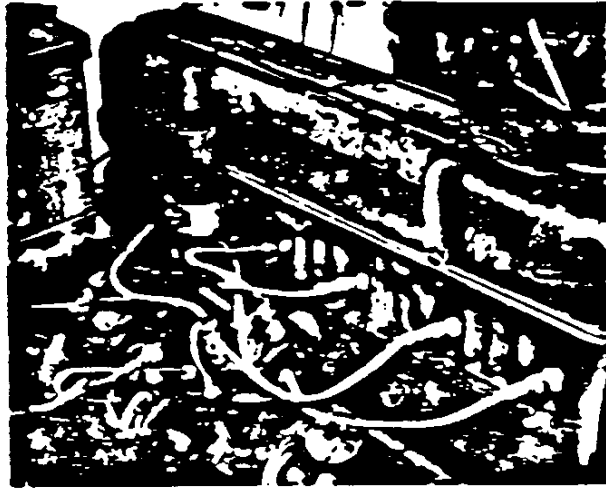

... to the crowded V-8 engine, the six-cylinder seems small for the available space.

The 123 H.P. SIX shown here is externally identical to the 136 horsepower version used with Powerglide installations.

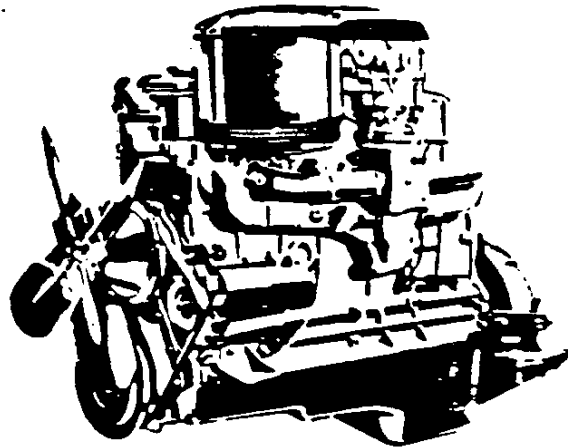

... horns are mounted ahead of the radiator.

1955 Chevrolet 123 horsepower SIX

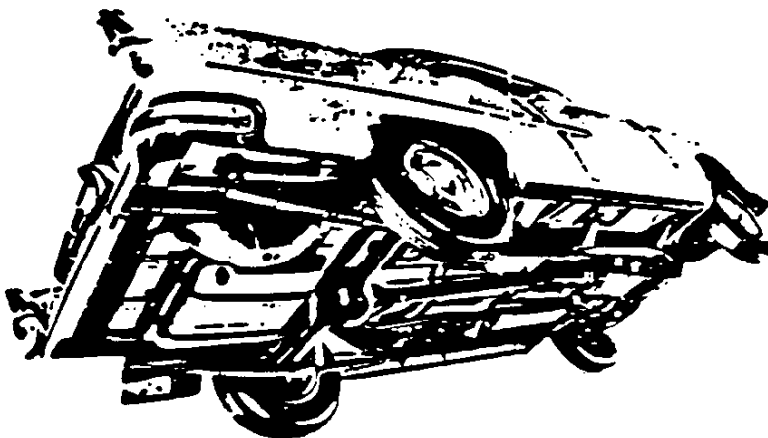

In an unusual illustration from the 1955 Sales Folder, Chevrolet's new 1955 chassis can be viewed easily.

1955 Nomad

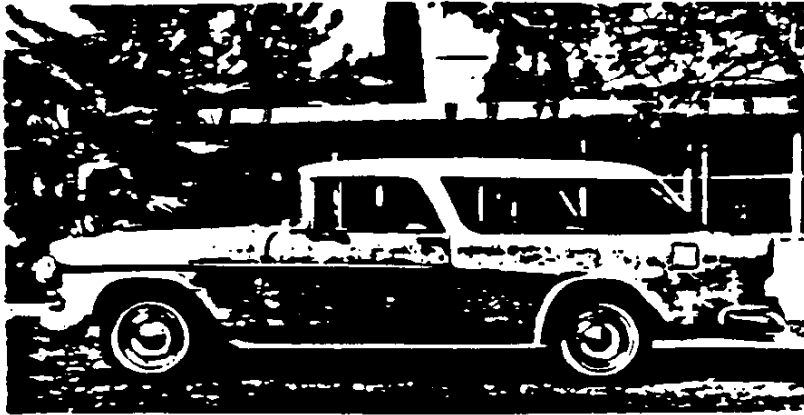

1955 Bel Air Nomad featuring optional two-tone paint.

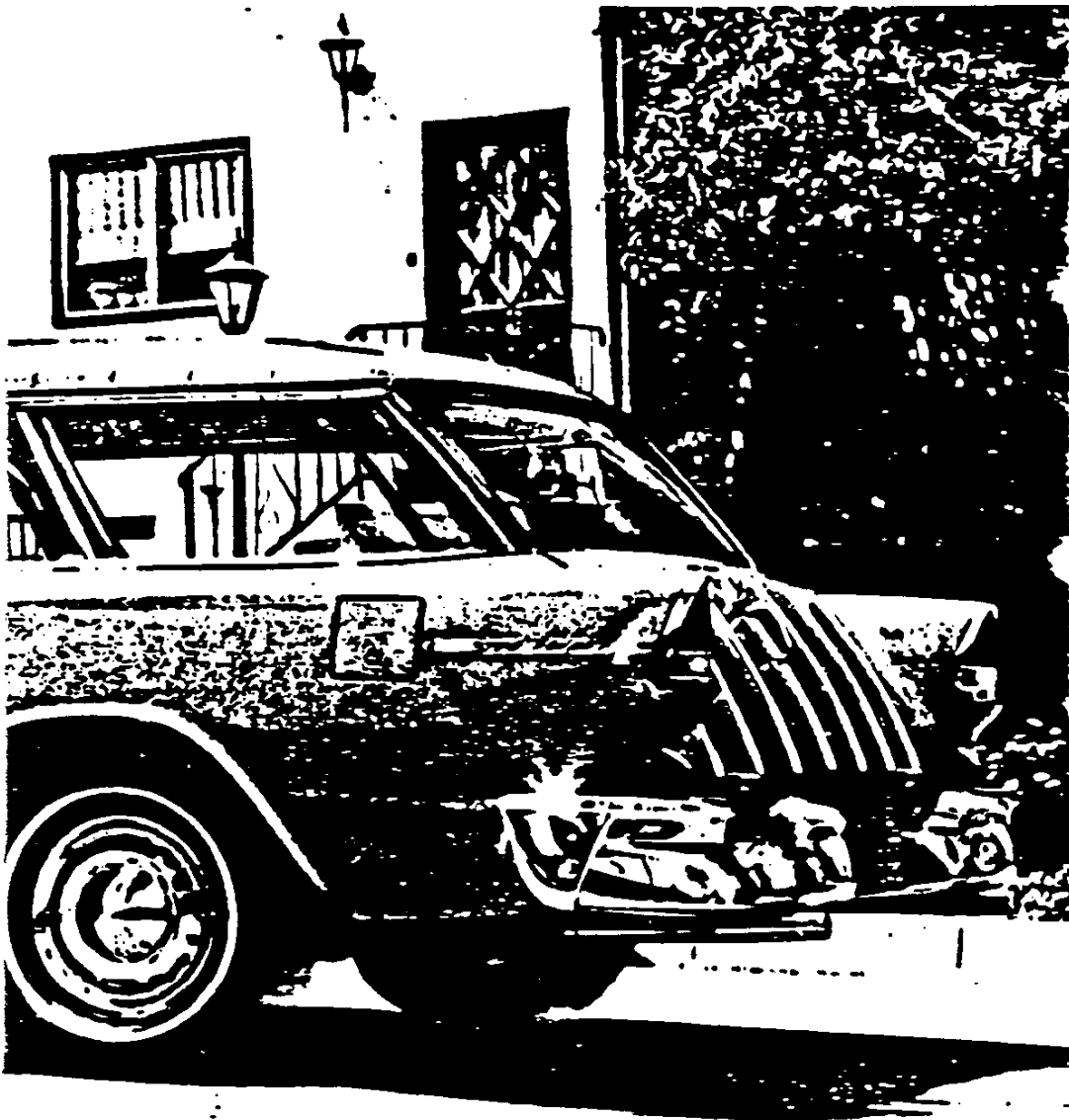

Mr. Earl Bryan, Bellflower, California

5 Nomad

Derived from a one-off "dream car" first shown at the GM Motordrome early in 1954, the attractive new 1955 Bel Air Nomad was a curious 2-door, 6-passenger station wagon. With unique mechanical features including a rear window that wrapped around to its rear post, the model featured a rear seat that could be folded to increase cargo space.

The Nomad was not Chevrolet's only 2-door 1955 station wagon. In addition there was offered a Two-Ten and a One-Fifty model, each with descending standard trim and upholstery. However, the Nomad is remembered best because despite unmistakably Bel Air looks, it failed to create a place for itself. The Nomad was to be continued for only two more years and then discontinued.

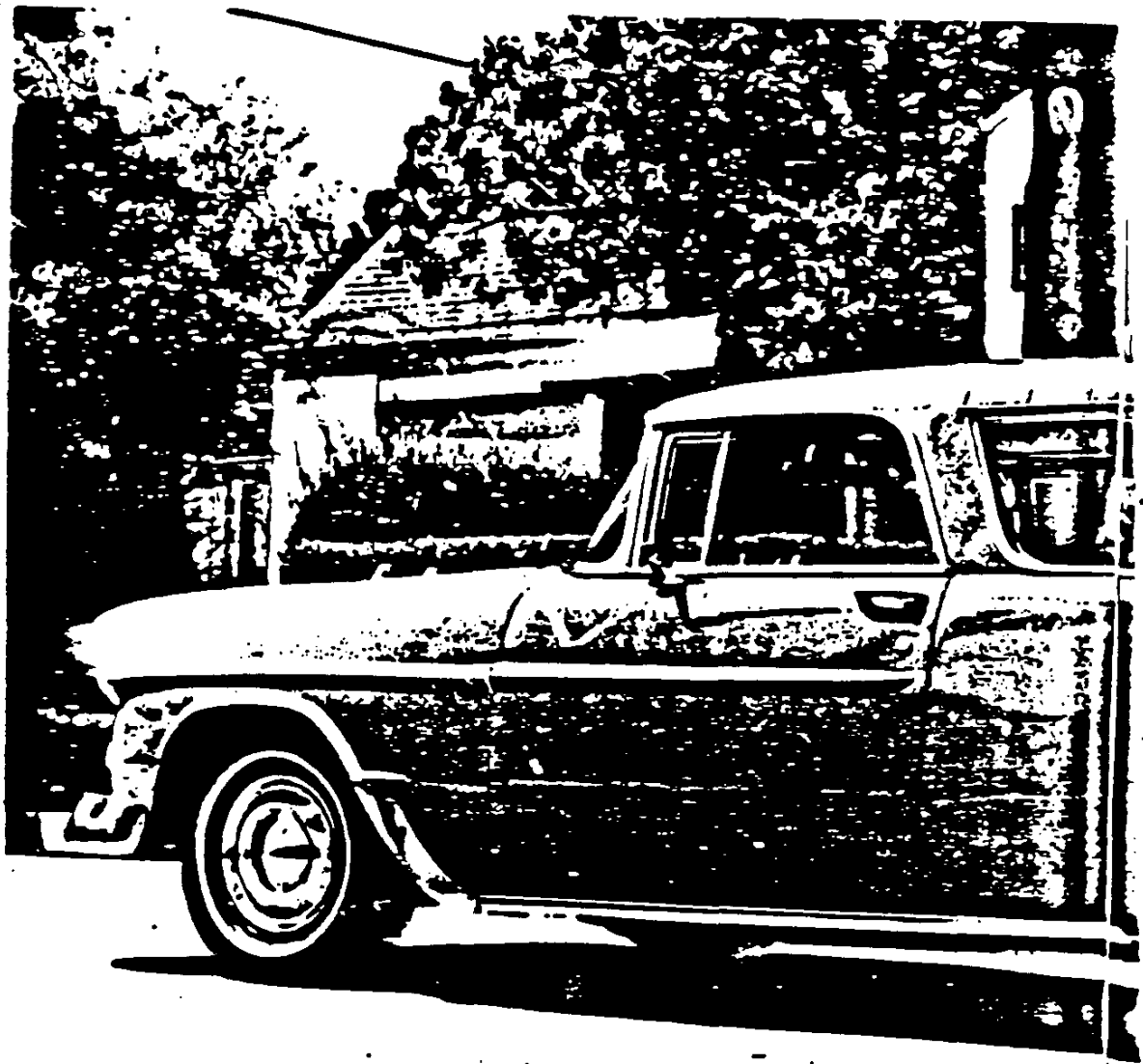

1955 Bel Air Nomad

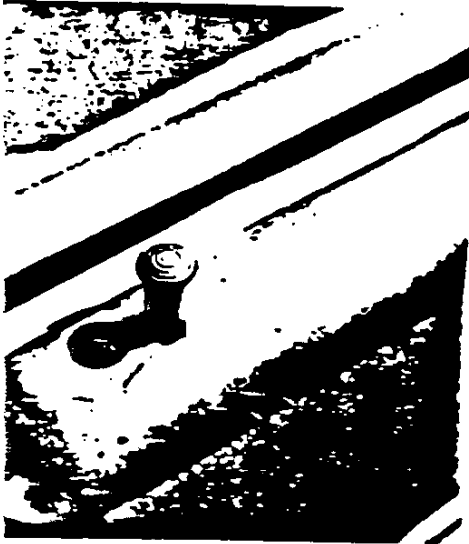

or locks are standard and protrude through

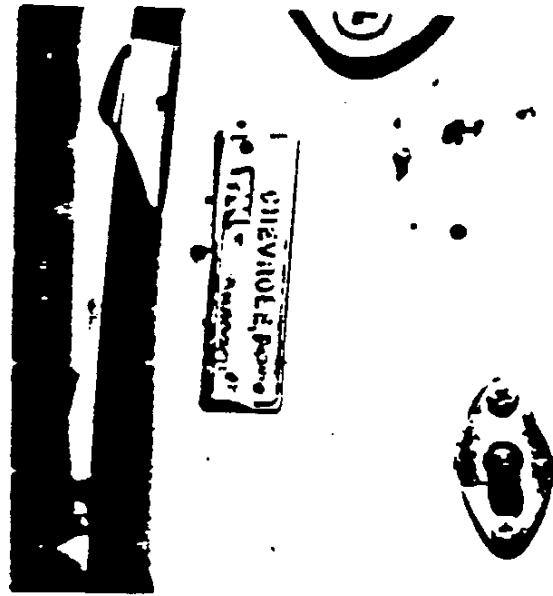

The use of a serial number plate on the left front door jamb is continued. The automatic switch for the interior lights is standard on all doors of the Bel Air Series cars and the front doors only in the Two-Ten models. It is not furnished on the One-Fifty Models.



The upholstery panels of the Bel Air Series are distinctively done in two-tone vinyl with bright metal trim strips and moulded in arm rests on the front

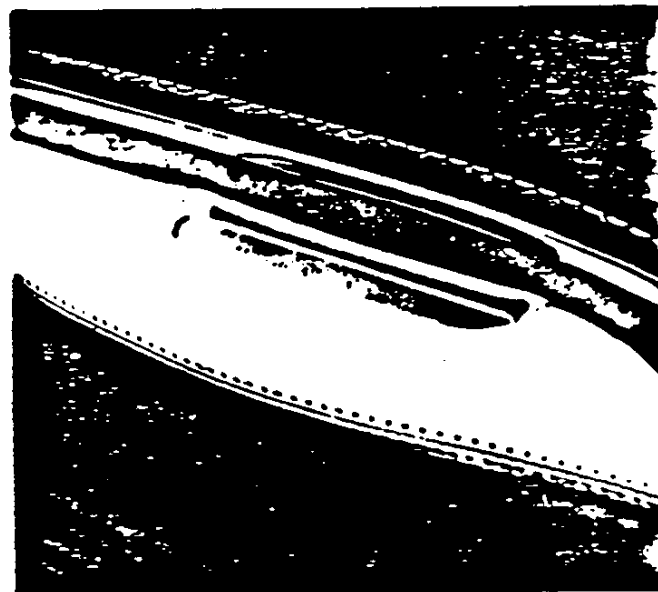
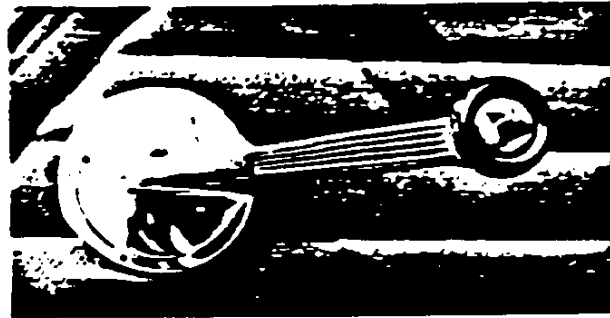
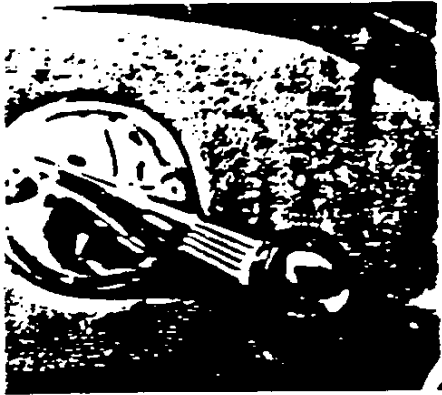

Moulded arm rests appear in the door panels of the Bel Air models. Conventional unitized arm rests are furnished in the front doors of the Two-Ten models and all station wagons. No arm rests are provided in the economy One-Fifty models.

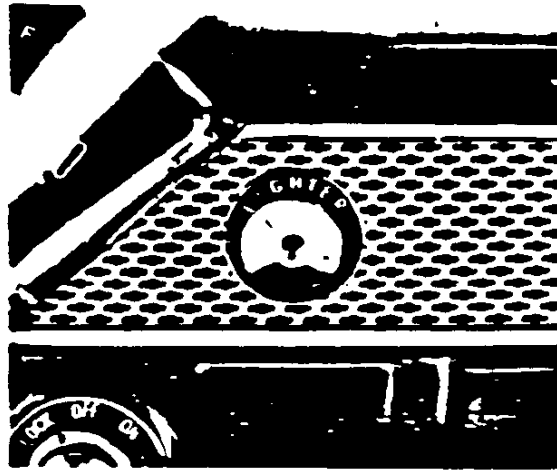
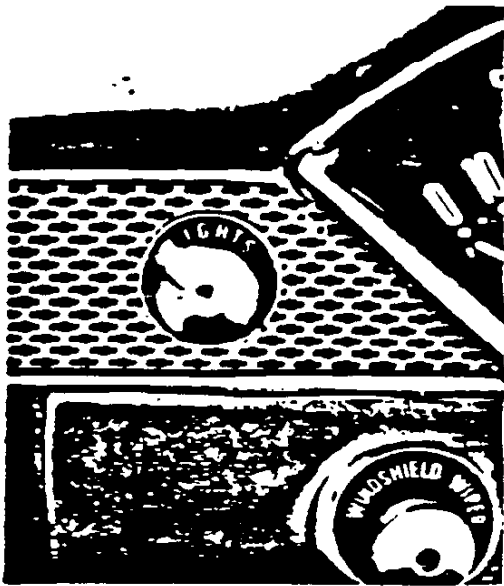

Function knobs on the 1955 instrument panel are fitted with legible eschutcheon plates.

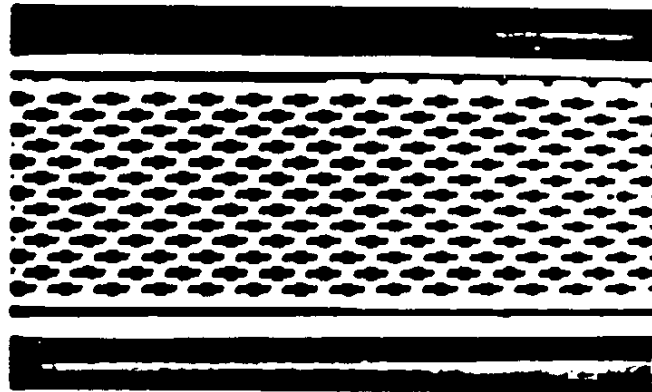
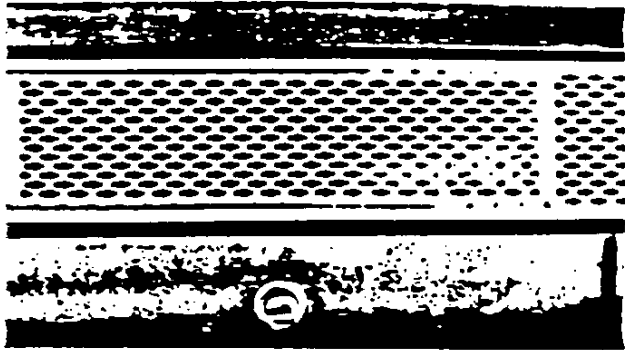

The Chevrolet bow-tie emblem is repeated endlessly in a pattern pierced in the instrument panel trim.

The radio blanking plate, furnished when that accessory is not chased, matches the bow tie trim. Beneath it can be seen the package compartment which has been placed at the center of the instrument panel.

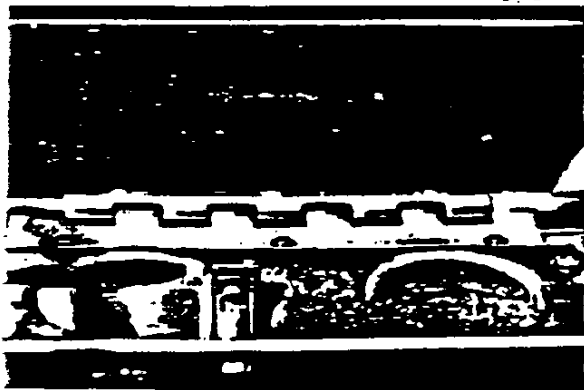

The package compartment has interior lighting (in Bel Air and Two-Ten models only) operated by the switch at the upper left.



The electric clock is standard in Bel Air models only, but available as an option in the others. Its speed is adjusted by a screw placed between the numerals at the top.

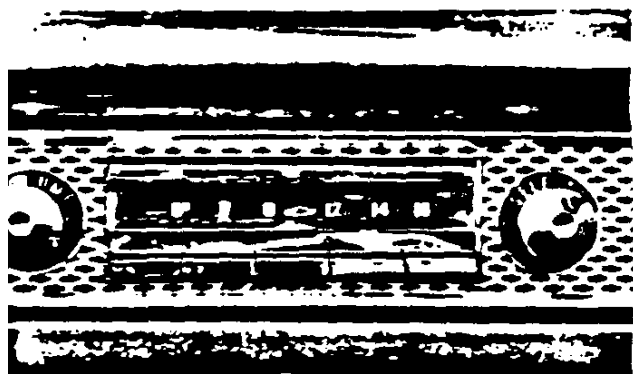

Available for the first time, in 1955, is this signal-seeking Under Bar push-button radio. A manual tuning economy model as well as a conventional push button version were also offered.

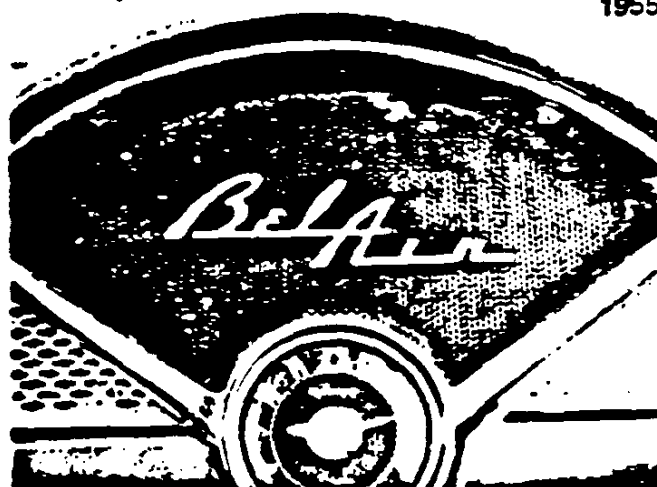

The radio speaker is installed behind this standard grille at the right side of the instrument panel. The decorative Bel Air nameplate is replaced by a Chevrolet script (below) on the Two-Ten and One-Fifty models.

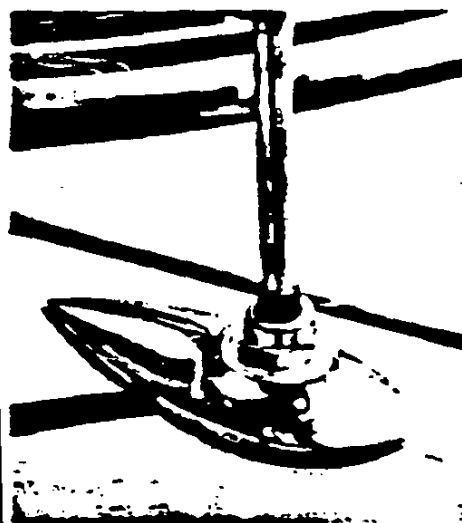

An antenna for the accessory radio is installed on the right front fender.

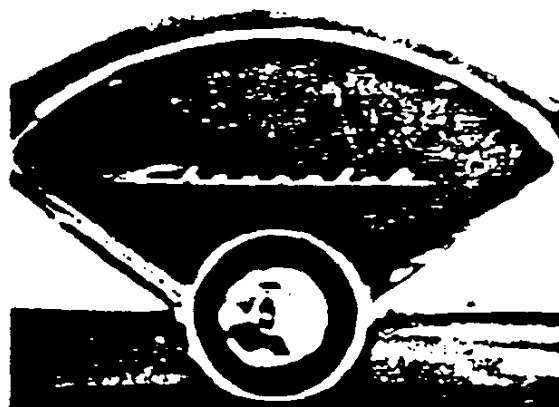

When the electric clock option is not installed in the Two-Ten or One-Fifty models, a blanking plate is furnished.

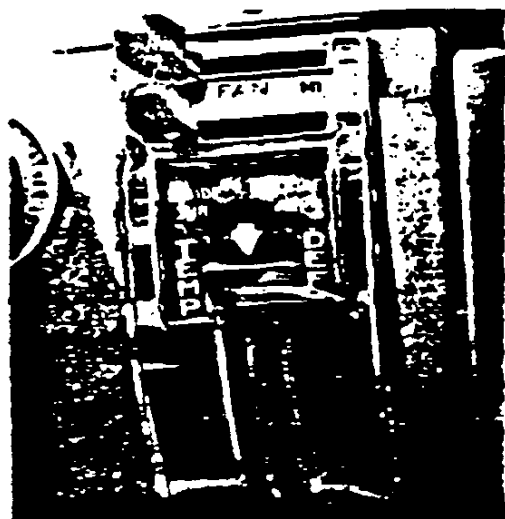

The optional Ventilating Heater and Defroster controls replace a standard blanking panel at the bottom of the instrument panel. An alternate economy Recirculating Heater control head also fits this space.



An ash receptacle is standard in the Bel Air Two-Ten Series, but is not furnished in the One-Fifty models.

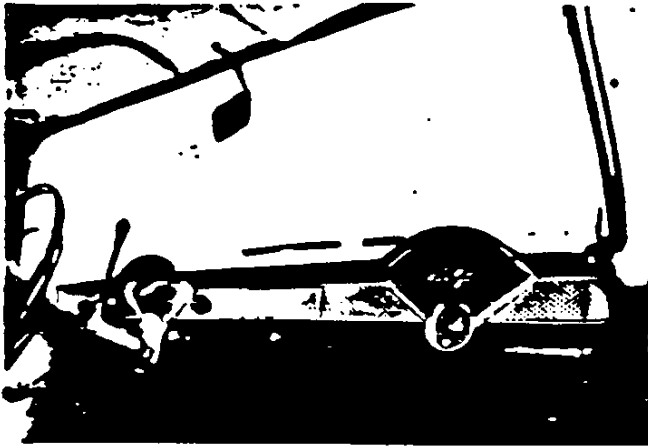

The basic Bel Air instrument panel, like the others, does not include a radio. This is an extra-cost accessory.

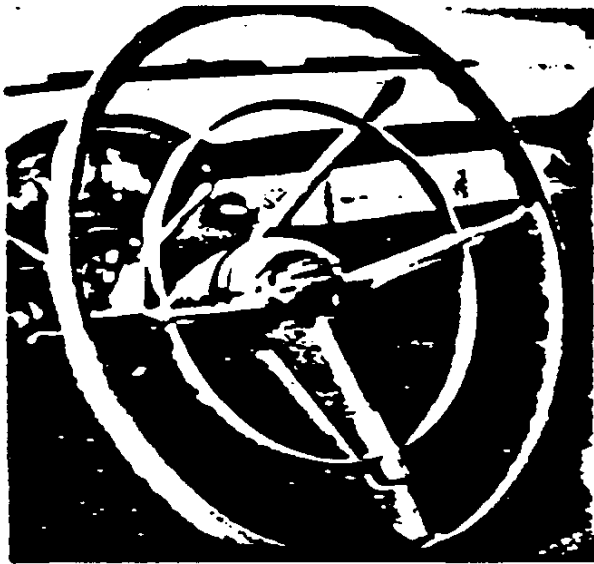

Reversing previous installations, the Bel Air series is furnished with a special three-spoke steering wheel with a full-circle horn blowing ring. Two-spoke steering wheels are used on the Two-Ten and One-Fifty cars, but the horn ring only appears in the Two-Ten.

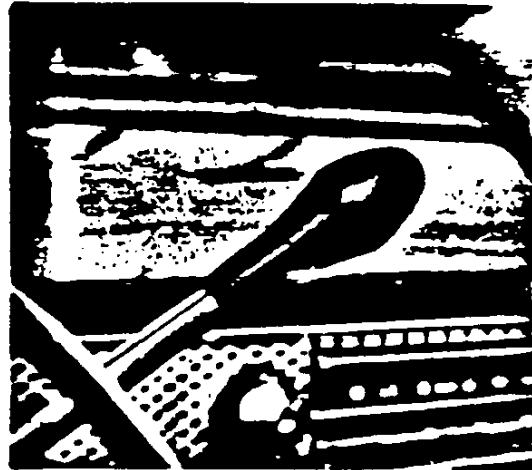

This unique black knob is used on both standard and automatic transmission shift levers.



Steering wheel hubs bear decorative emblems. This one signifies a six-cylinder engine car. A "V" emblem (page 226) is used on eight cylinder cars.

new 12-volt electric system appeared in the 1955 models ending the use of the former 6-volt system. Although functionally similar, there is therefore no interchangeability between 1955 and earlier electric components such as instruments, radio, clock, lamp bulbs, starter, generator, etc.

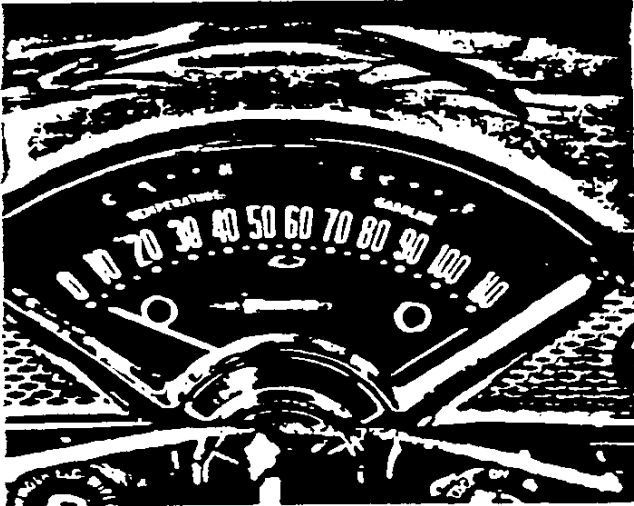

entirely new speedometer is housed beneath a hooded in the surface of the instrument panel.

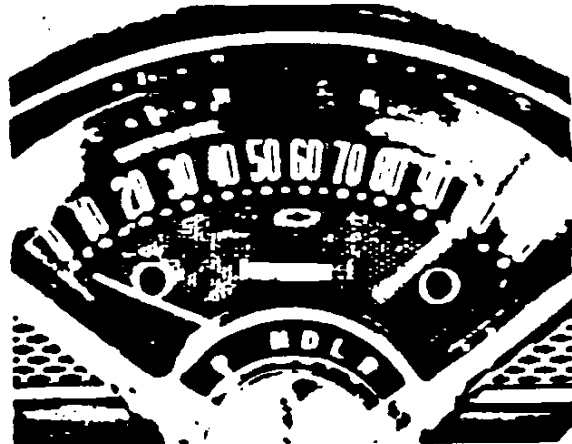

Optional Powerglide brings a visible indicator at the base of the speedometer. Standard transmission installations are fitted with a blanking plate at this point (left).

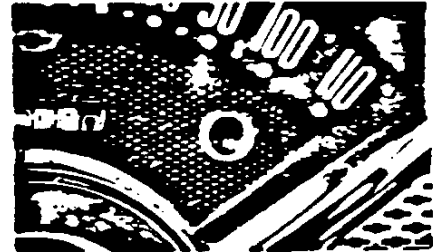

Round warning lights (above and left) replace the gauges and illuminate to warn of Low Oil Pressure (above) or Battery Discharge.

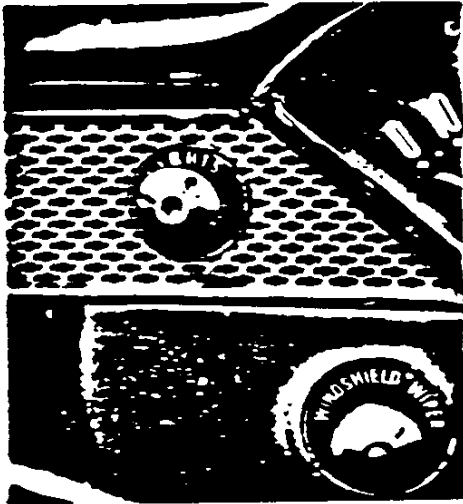

New knobs are used on the instrument panel.



Functionally unchanged, the ignition switch is flanked by a standard blanking plate (above) or optional heater controls (below). Beneath the switch (below) can be seen the Over-drive control.



A new T-handle parking brake is moved to the driver's side, and foot pedals are now suspended. (compare page 160.)

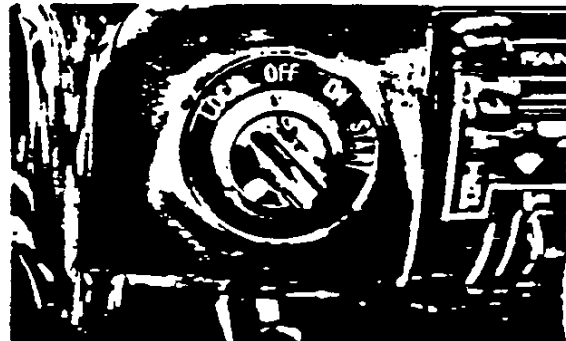

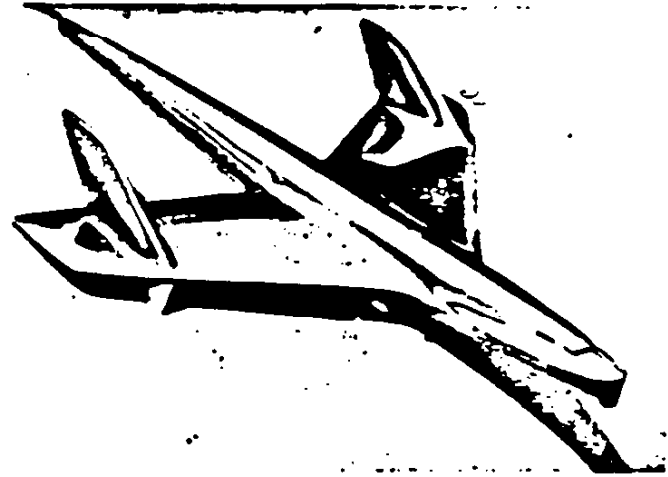

A new hood ornament having a longer look than the 1953 style (page 154) now appears.



These are accessory bumper tips, added to give a more massive appearance.



A new longer, and narrower, hood ornament now appears.

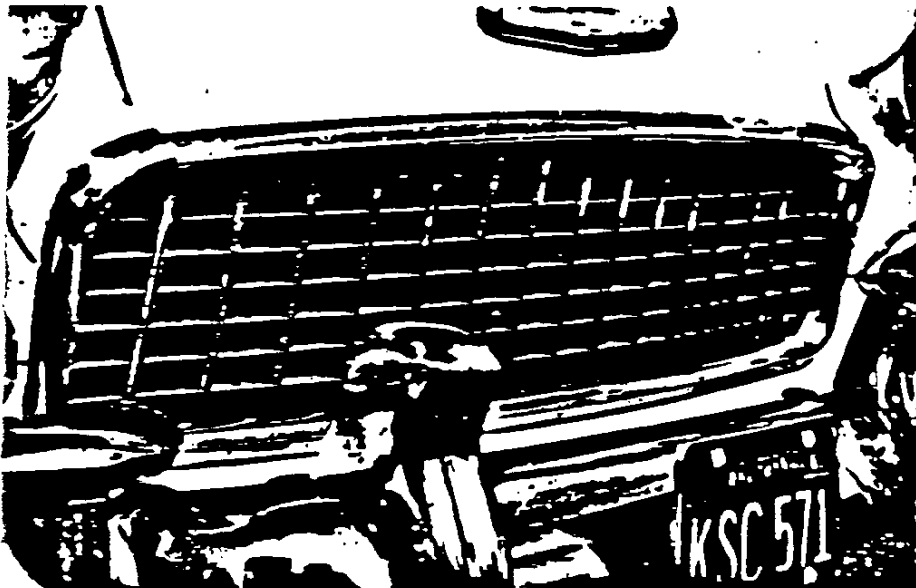

1955, Chevrolet could well have advertised "The Name's Same, but Change is the game", for this was the year for partial revision.

distinctive, entirely new style was unveiled. Built on the 115" wheelbase as previously, Chevrolet managed to keep the passenger car height and increase the overall length by 1 1/2 inches in a restyling that gave a new graceful appearance to the cars. Within the framework of the three-Series line up no changes were made, although some were merely restyling of previous models.

1955 saw the introduction of the Nomad, a new concept in a two-door six-passenger luxury sedan with the styling ability of a station wagon. With unique trim and uniquely attractive interiors, Chevrolet had made styling modifications to the less-well-remembered Two-Ten 2-door station wagon and produced this memorable new Bel Air 1.

Power windows became optionally available in all Series. These included for 1955 Chevrolet's first "factory air", extension of power windows option to all windows, new Power Brakes, new windshields wipers, and the added options of Power-Overdrive, directional signals, and many more.

With all of this, 1955 still remains best known for its introduction of Chevrolet's new V-8 engine, the first since 1918. With a 265 cubic inch displacement (3.75" bore x 3.0" stroke), the engine featured an 8.0 to 1 compression ratio and was rated at 162 horsepower. It was available with standard three-speed transmission, with or without additional Overdrive, and in a beefed-up version featuring hydraulic lifters and chain-drive timing, in Powerglide installations. Nor was this all; a factory option provided for a larger 4-barrel carburetor and dual exhausts for even greater power.

For those whose affiliation to the long-lived Chevrolet SIX was to be considered, the 1955 Chevrolet also offered two new versions of that engine. The 123 horsepower 235.5 cid version with a 3.56 bore and 3.94 stroke was used with standard transmission with or without Overdrive. Powerglide installations were fitted with a similar engine with hydraulic lifters and a high-lift cam for a rating of 136 horsepower. Both engines used aluminum pistons in place of the cast iron pistons found in Chevrolet's earlier Six Cylinder engines, and both had a new floating-intake oil pump designed to prevent sludge from the bottom of the oil sump from entering the pump.

ENGINEERING SPECIFICATIONS

EXTERIOR DIMENSIONS
 Overall length, 195.4"
 Overall wheelbase, 115.0"
 Overall height, 55.1"
 Front overhang, 35.1"
 Rear overhang, 30.1"
 Ground clearance, 5.5"
 Max. load capacity, 1,500 lbs.
 Max. tongue weight, 300 lbs.

ENGINE PLANT
 V-8, V-6, V-4, and V-6 engines available
 Cooling system, radiator, water pump, fan, belts, hoses, and thermostat
 Lubrication system, oil pan, oil pump, oil filter, distributor, timing belt, and camshaft
 Ignition system, distributor, spark plugs, spark wires, and distributor cap
 Drive shafts, universal joints, and axles
 Exhaust system, manifold, catalytic converter, and tailpipe
 Power windows, power locks, and power mirrors
 Power brakes, master cylinder, wheel cylinders, and brake shoes
 Power steering, steering gear, and tie rods
 Power suspension, shock absorbers, and springs
 Power seats, seat adjusters, and seat belts
 Power door locks, door latch, and door handle
 Power windows, power locks, and power mirrors
 Power brakes, master cylinder, wheel cylinders, and brake shoes
 Power steering, steering gear, and tie rods
 Power suspension, shock absorbers, and springs
 Power seats, seat adjusters, and seat belts
 Power door locks, door latch, and door handle

CONTROLS

Steering wheel, column, and shaft
 Steering knuckles, tie rods, and ball joints
 Steering rack and pinion
 Suspension system, springs, shock absorbers, and struts
 Braking system, master cylinder, wheel cylinders, and brake shoes
 Parking brake, drum, and cable
 Clutch pedal, master cylinder, and slave cylinder
 Throttle pedal, accelerator cable, and carburetor
 Brake pedal, master cylinder, and slave cylinder
 Ignition switch, distributor, and spark plugs
 Power windows, power locks, and power mirrors
 Power brakes, master cylinder, wheel cylinders, and brake shoes
 Power steering, steering gear, and tie rods
 Power suspension, shock absorbers, and springs
 Power seats, seat adjusters, and seat belts
 Power door locks, door latch, and door handle

BODY CONSTRUCTION

Structural members, floor, and roof
 Body panels, doors, and trunk
 Bumpers, front and rear
 Grilles, hood, and trunk lid
 Fenders, front and rear
 Wheel covers, hubcaps, and tires
 Mirrors, side and rear view
 Door locks, power windows, and power locks
 Power windows, power locks, and power mirrors
 Power brakes, master cylinder, wheel cylinders, and brake shoes
 Power steering, steering gear, and tie rods
 Power suspension, shock absorbers, and springs
 Power seats, seat adjusters, and seat belts
 Power door locks, door latch, and door handle

BODY EQUIPMENT

Windows, curtains, and door seals
 Floor mats, trunk mat, and door sill plates
 Spare tire, jack, and tire inflator
 First aid kit, fire extinguisher, and tool kit
 Radio, stereo, and speaker system
 Clock, tachometer, and speedometer
 Power windows, power locks, and power mirrors
 Power brakes, master cylinder, wheel cylinders, and brake shoes
 Power steering, steering gear, and tie rods
 Power suspension, shock absorbers, and springs
 Power seats, seat adjusters, and seat belts
 Power door locks, door latch, and door handle

GROUP CLASS	CONVENTIONAL		OVERDRIVE		AUTOMATIC	
	123-hp 6c	163-hp V8	123-hp 6c	163-hp V8	123-hp 6c	163-hp V8
Engine Size	225.5 cu. in. displacement, 3.56" bore, 3.94" stroke, 7.2 to 1 compression ratio	265.0 cu. in. displacement, 3.75" bore, 3.0" stroke, 8.0 to 1 compression ratio	225.5 cu. in. displacement, 3.56" bore, 3.94" stroke, 7.2 to 1 compression ratio	265.0 cu. in. displacement, 3.75" bore, 3.0" stroke, 8.0 to 1 compression ratio	225.5 cu. in. displacement, 3.56" bore, 3.94" stroke, 7.2 to 1 compression ratio	265.0 cu. in. displacement, 3.75" bore, 3.0" stroke, 8.0 to 1 compression ratio
Engine Features	Concentric carburetor, 4-bearing crankshaft, Over drive timing	Dual carburetor, Advancing crankshaft, Chain drive timing	Concentric carburetor, 4-bearing crankshaft, Over drive timing	Dual carburetor, Advancing crankshaft, Chain drive timing	Concentric carburetor, 4-bearing crankshaft, Over drive timing	Dual carburetor, Advancing crankshaft, Chain drive timing
Block	9 1/2" dia.	10" dia.	9 1/2" dia.	10" dia.	9 1/2" dia.	10" dia.
Block Material	Cast-iron block with aluminum alloy pistons		Cast-iron block with aluminum alloy pistons		Cast-iron block with aluminum alloy pistons	
Transmission	Overdrive transmission with Overdrive*		Overdrive transmission with Overdrive*		Automatic transmission*	
Power Windows	Optional, power windows, electric door latches, with overhead door latching system		Optional, power windows, electric door latches, with overhead door latching system		Optional, power windows, electric door latches, with overhead door latching system	
Power Brakes	Optional, power brakes, master cylinder, wheel cylinders, and brake shoes		Optional, power brakes, master cylinder, wheel cylinders, and brake shoes		Optional, power brakes, master cylinder, wheel cylinders, and brake shoes	
Power Steering	Optional, power steering, steering gear, and tie rods		Optional, power steering, steering gear, and tie rods		Optional, power steering, steering gear, and tie rods	
Power Suspension	Optional, power suspension, shock absorbers, and springs		Optional, power suspension, shock absorbers, and springs		Optional, power suspension, shock absorbers, and springs	
Power Seats	Optional, power seats, seat adjusters, and seat belts		Optional, power seats, seat adjusters, and seat belts		Optional, power seats, seat adjusters, and seat belts	
Power Door Locks	Optional, power door locks, door latch, and door handle		Optional, power door locks, door latch, and door handle		Optional, power door locks, door latch, and door handle	
Other Data	3.79 to 1 ratio		4.11 to 1 ratio		3.53 to 1 ratio	

OPTIONAL EQUIPMENT
 Radio, stereo, and speaker system
 Clock, tachometer, and speedometer
 Power windows, power locks, and power mirrors
 Power brakes, master cylinder, wheel cylinders, and brake shoes
 Power steering, steering gear, and tie rods
 Power suspension, shock absorbers, and springs
 Power seats, seat adjusters, and seat belts
 Power door locks, door latch, and door handle



New wrap-around front bumpers sweep well around the front corners to the wheel opening.



This Chevrolet script appears on the front fenders of the Two-Ten and the One-Fifty Series cars only.

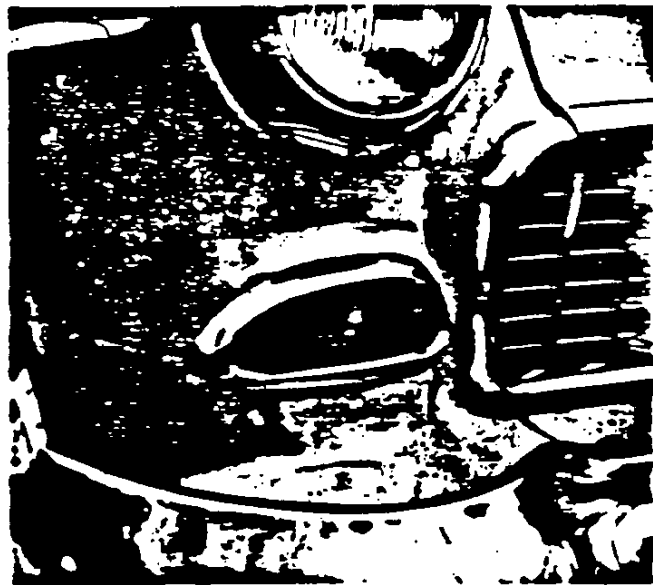

New tear-drop shaped parking lamps appear below the headlights in a simplified housing exposing a parting line in the fender side panel.





lean, uncluttered look of the 1955 Chevrolet results largely from the use of a new and front bumper.



The new, more massive bumpers require a new guard.

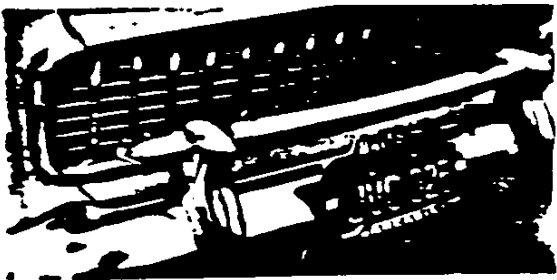

This grill guard is an accessory which replaces the two standard bumper guards as well.





Although the fenders all have the characteristic "crease", only on the Bel Air series does the added front trim strip appear. Wheel size remains at 15 inches, tires are 6.70 x 15 as previously.

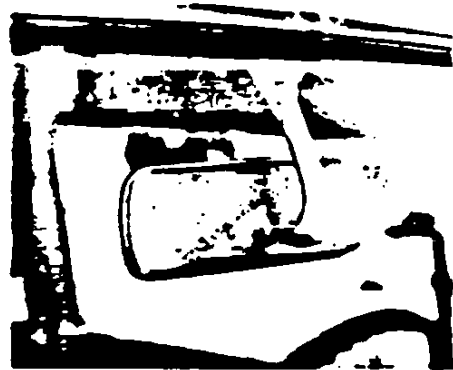

The inside rear view mirror is now suspended from above the windshield on all models, including the Sport Coupe.

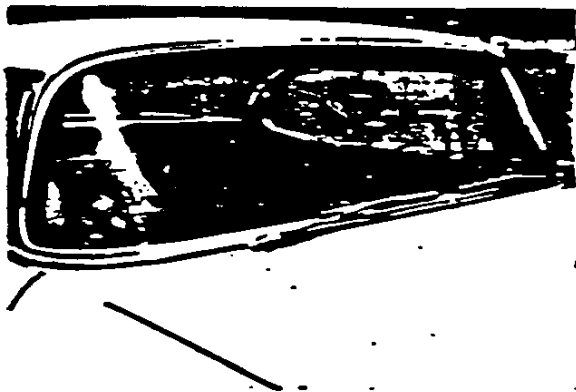

A new "Sweep-Sight Windshield" curves around at the ends. The bright metal trim around the glass is again omitted on the One-Fifty models.



Just forward of the windshield, a grill now appears, the high-level entry point for ventilating air.

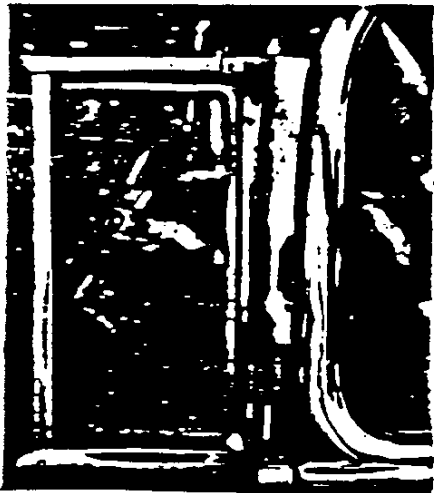

With vertical windshield pillar, the new

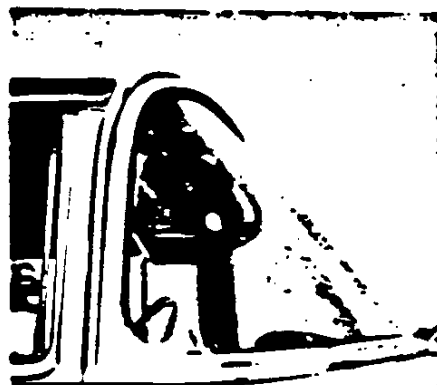

The ends of the new wrap-around windshield

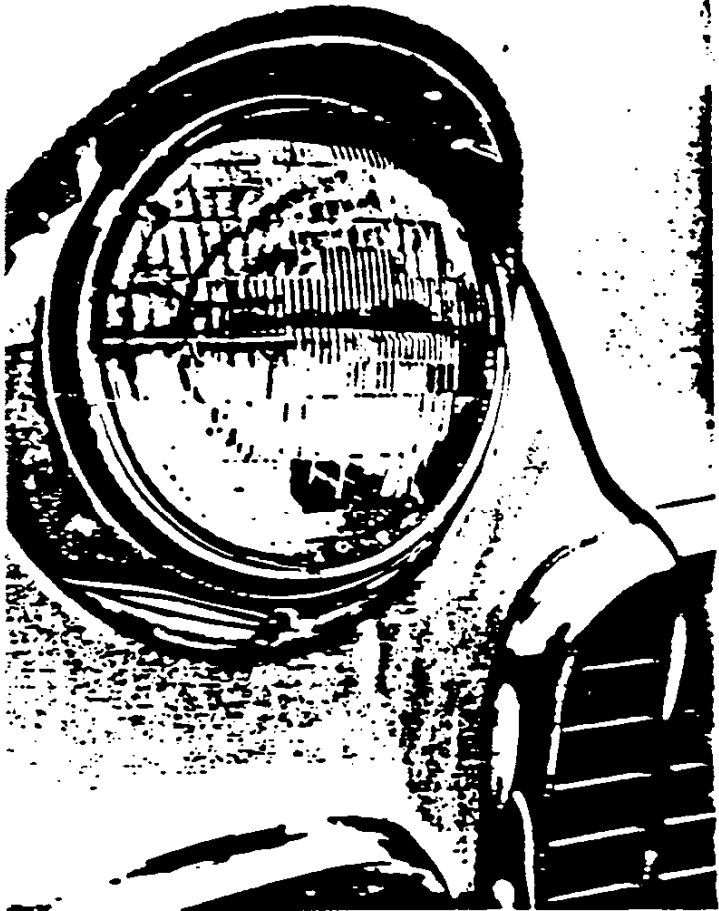

y formed fenders have a protruding "brow" over the headlamps.

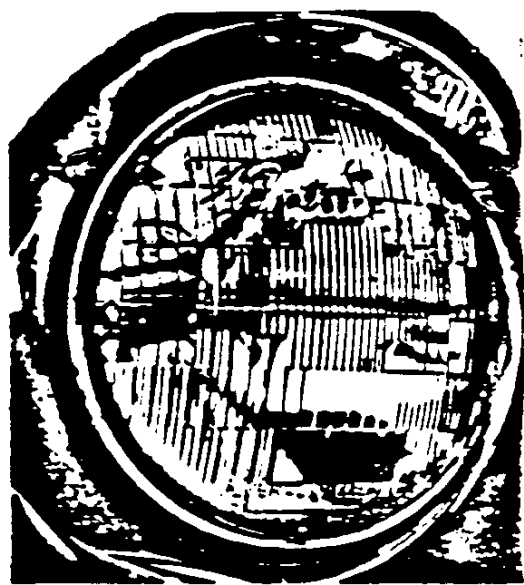

A chromed headlight bezel emphasizes the visor-like effect of the fenders.

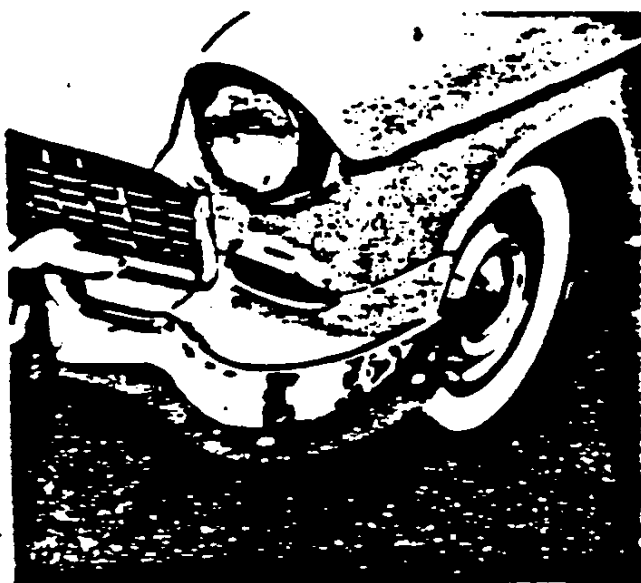

The entire front corner of the car has been re-styled to emphasize the forward thrust of the vehicle.

1955



The TWO-TEN Series has, in addition to the simulated air scoop of the Bel Air, a single stripe on its rear fenders. The ONE-FIFTY cars are devoid of such ornamentation.

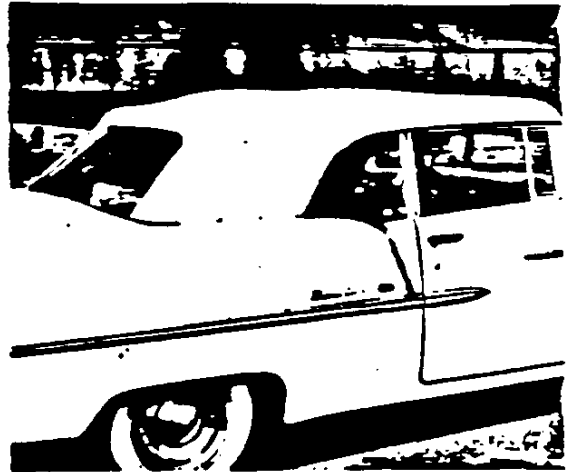

The rear fenders of the BEL AIR Series cars have a dual stripe trim and other distinctive features (below).

Bel Air

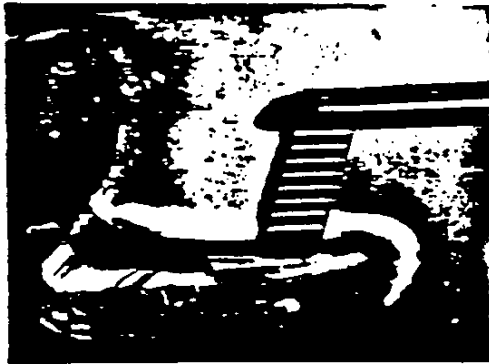

Added trim characteristics of the Bel Air Series cars are the nameplate and side emblem, and the trim plate just above the rear bumper tips.

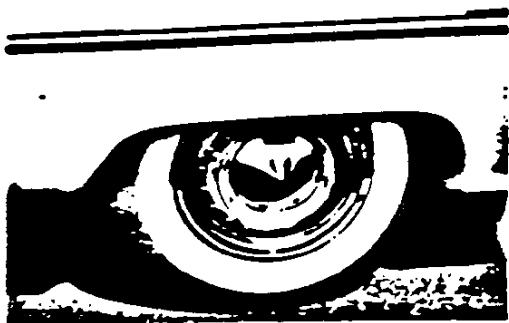

Wheel cover panels, long a characteristics of the Bel Air Series, are deleted with the advent of

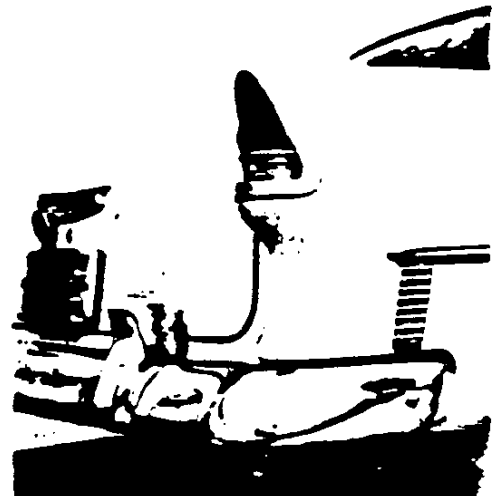



An added wind and rain deflector above the front windows of the Bel Air Sport Coupe is hinged and triggered to flip up (left) when the door is opened.



With windows lowered, the Bel Air Sport Coupe passengers have an unobstructed view.



Metal-framed windows of the Bel Air Sport Coupe can be lowered into the body.

1955

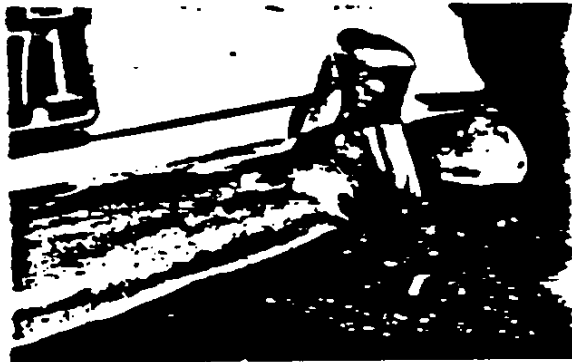
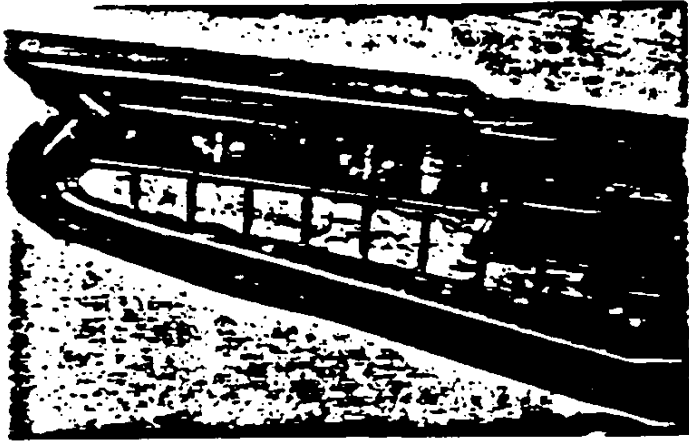

Restyled rear bumper guards contain lamps to illuminate the license plate.

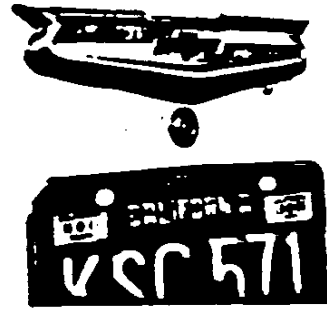

A handsome new ornamental emblem appears on the rear deck lid as well as the hood.

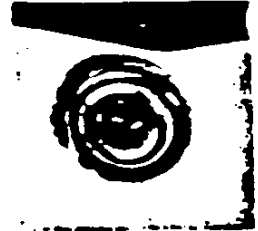

The separate key lock releases the rear deck lid latch.

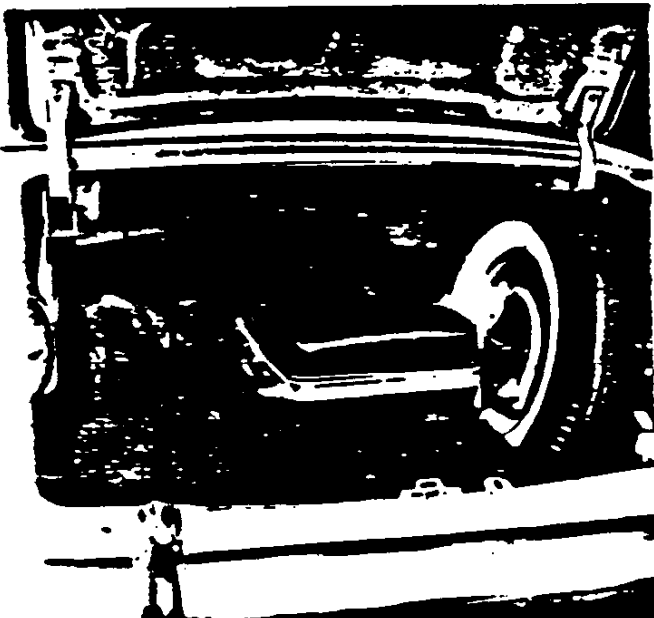

A rubber mat appears in the large luggage compartment. The



Jacking instructions are placed in the luggage compartment inside the right rear fender.

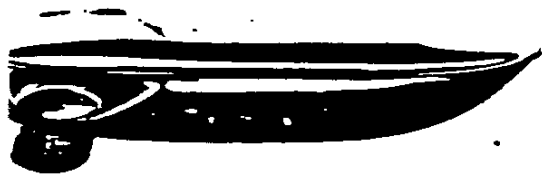

outside door handles with oval push-buttons replace earlier round-button style (page 157).



A dress-up accessory trim plate behind the door handle helps to protect the door paint.



A return to the separate outside door lock in place of the earlier style (page 157) adds a keylock below the front door handles.

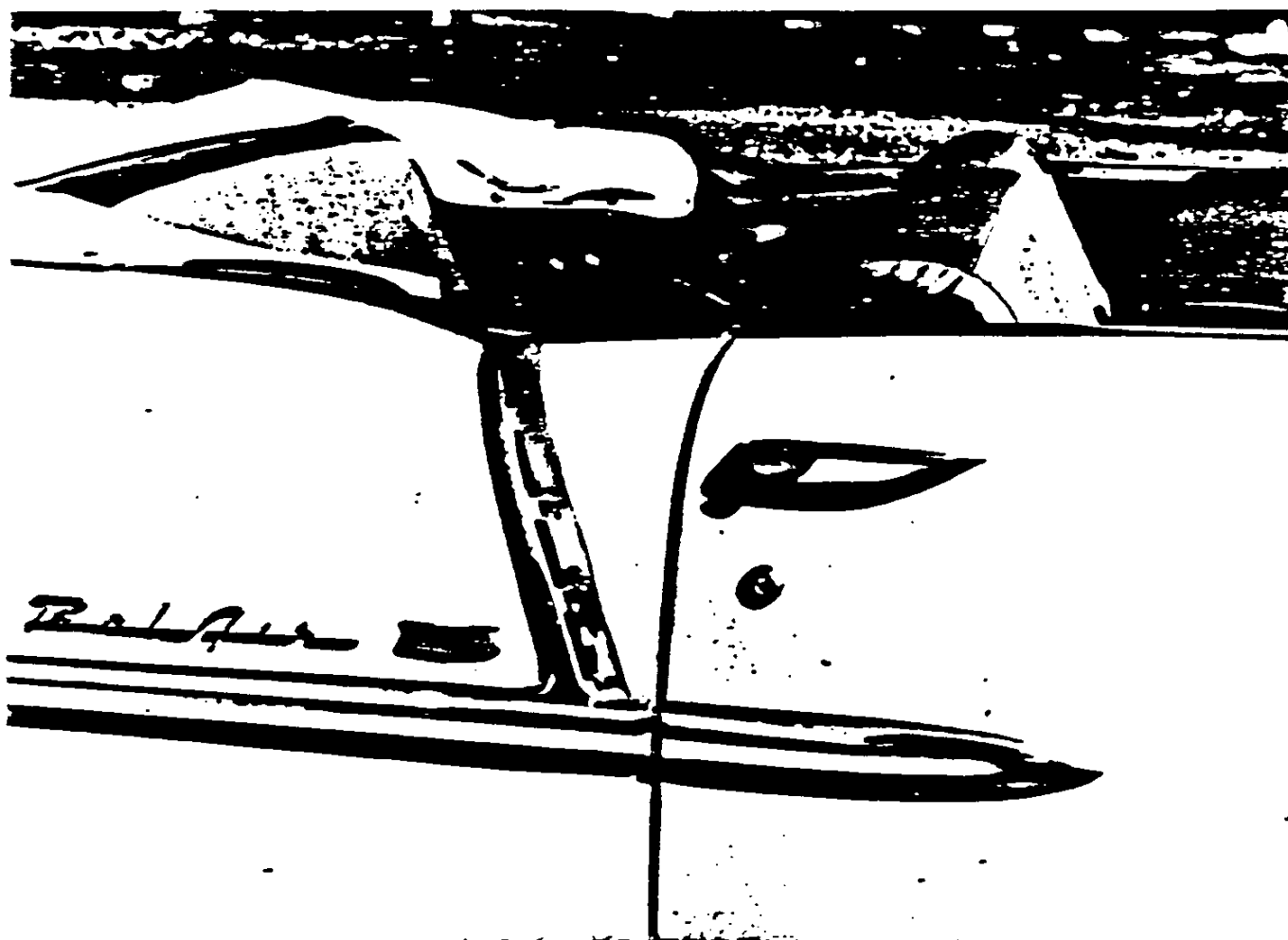

trim strip, simulating an air scoop, is placed at the hipline of the Bel Air and the Two-Ten series cars.

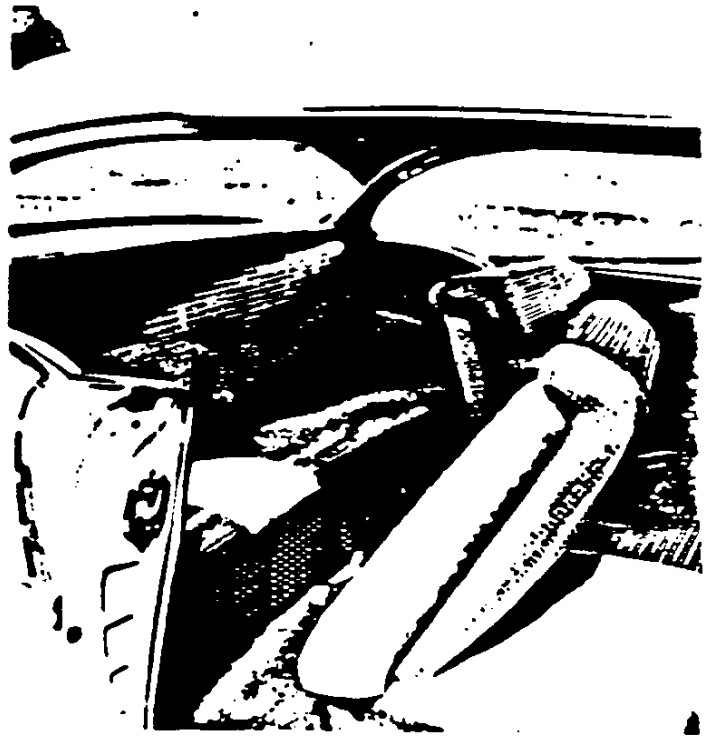

The 1955 Bel Air Convertible interior is inviting and access to the rear seat is adequate. (The current owner has installed protective vinyl slip covers.)

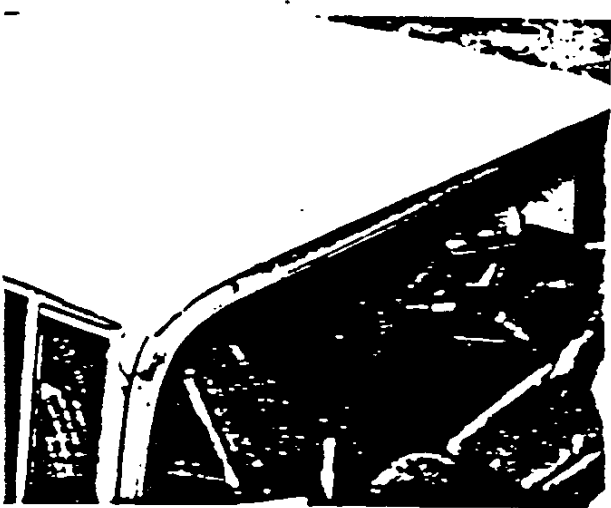

The folding top of the Convertible is power-operated.

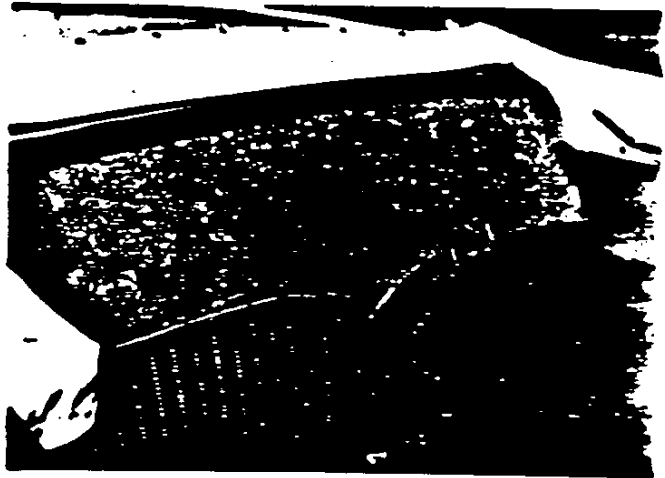

A distinctive two-tone pattern is used on the seats of the Convertible.

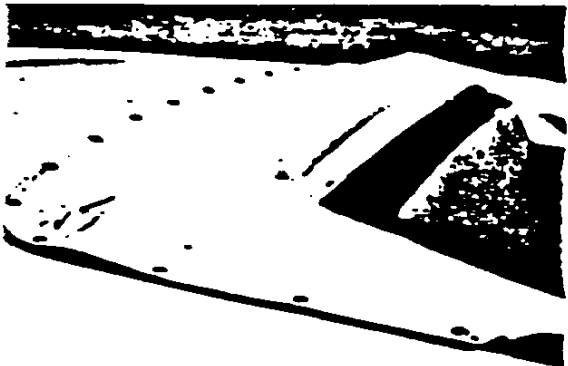

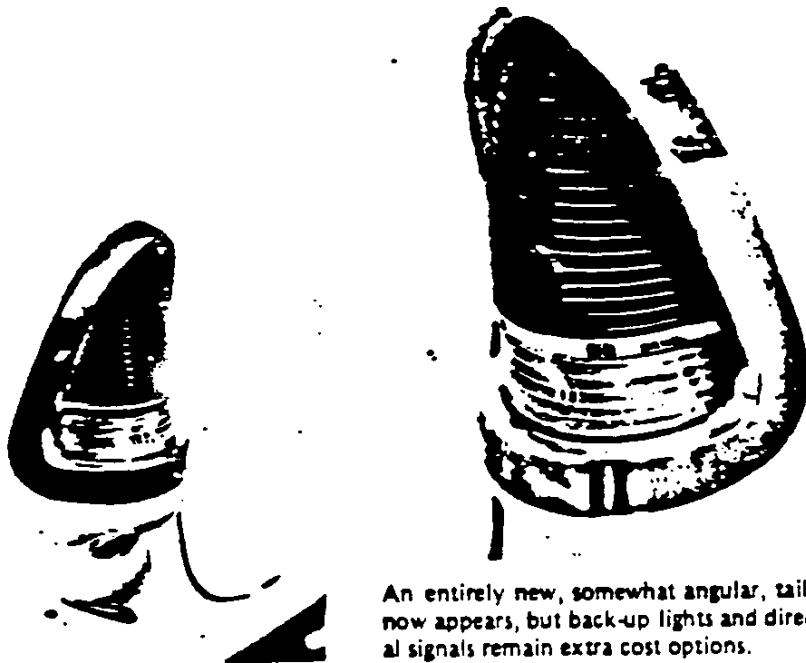

An entirely new, somewhat angular, tail light now appears, but back-up lights and directional signals remain extra cost options.

tail light assembly is designed as a part of the rear fender into which

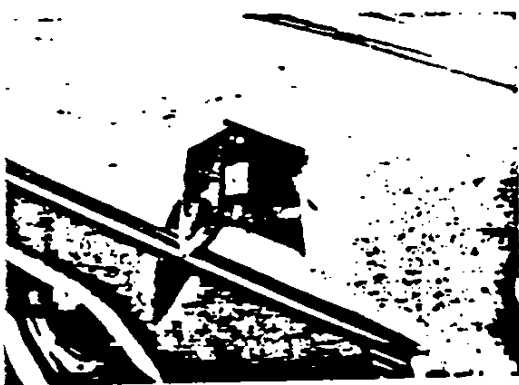

The gas tank filler tube is located under a flap in the left rear fender. Unlike past installations, (page 159), the flap is now hinged at its forward edge.



This emblem appears under the tail lights (upper left) only on those cars in which the V-8 engine is installed.

The factory-installed Plus Power Package option included a four-barrel carburetor and dual exhausts on the V-8 engine. Dress-up, "Power Pack" tips were also provided on the exhaust pipes (below).



Standard Chevrolet exhaust pipe is oval.

1955

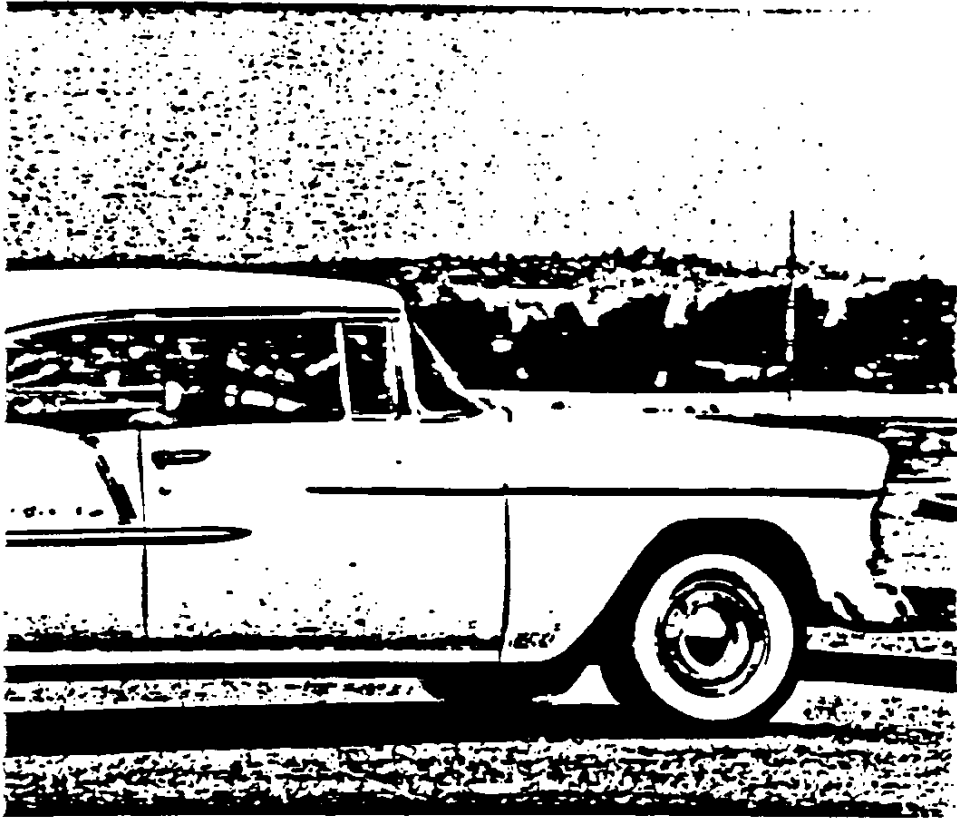

Jon Guilmet, San Diego, California



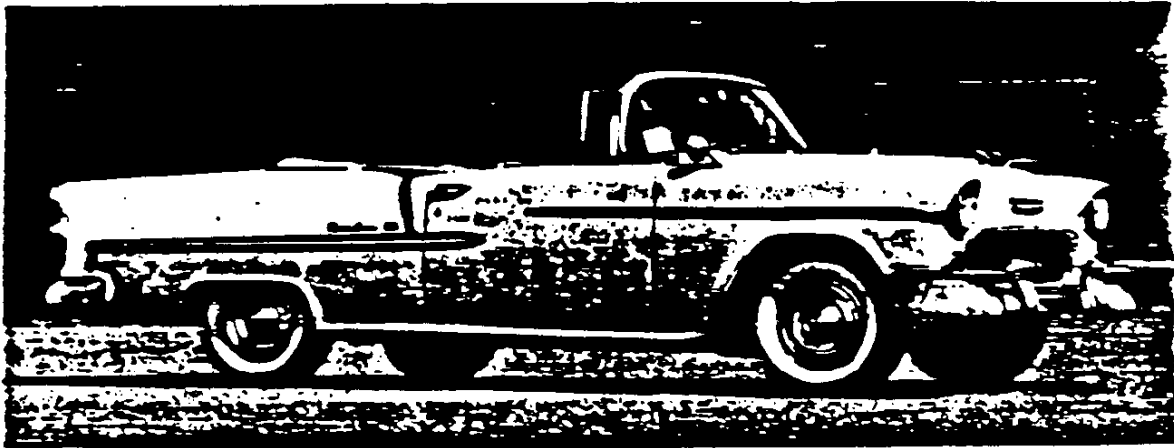

1955 Bel Air Convertible

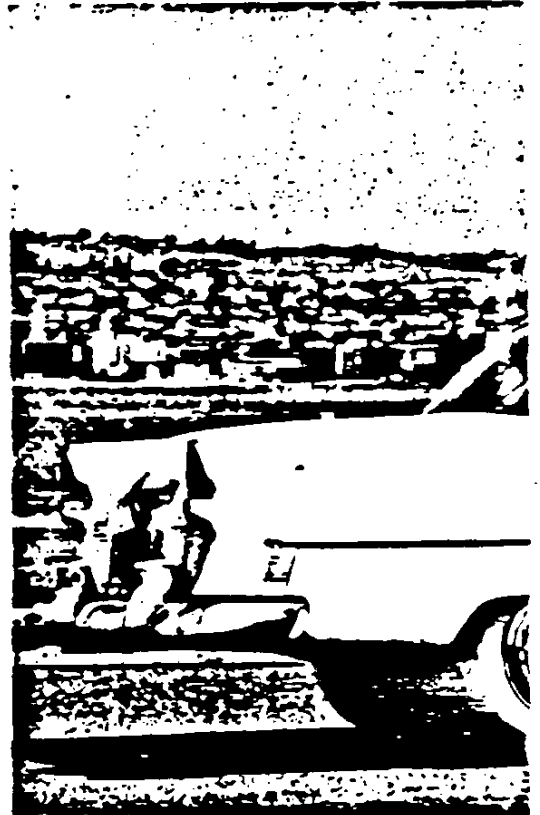

1955 Bel Air Sport Coupe

1955 Two-Ten 2-door Sedan

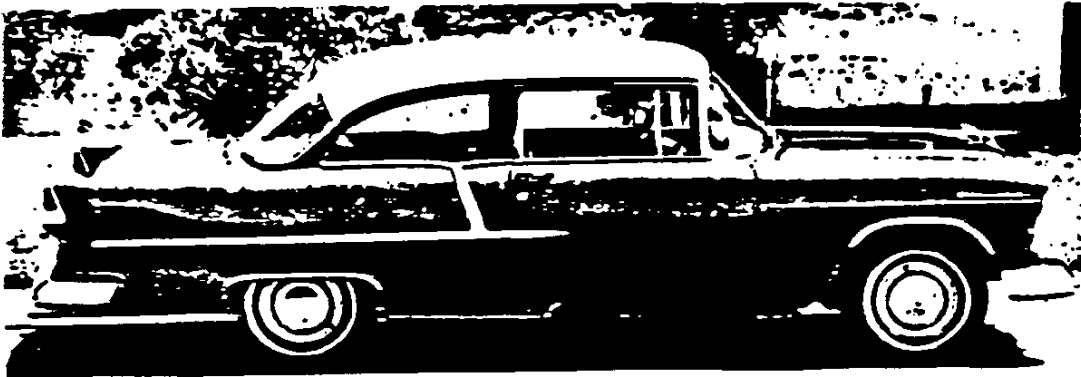

**Some 1955
Accessories**

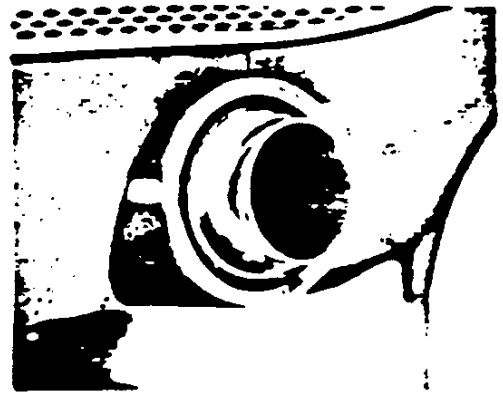
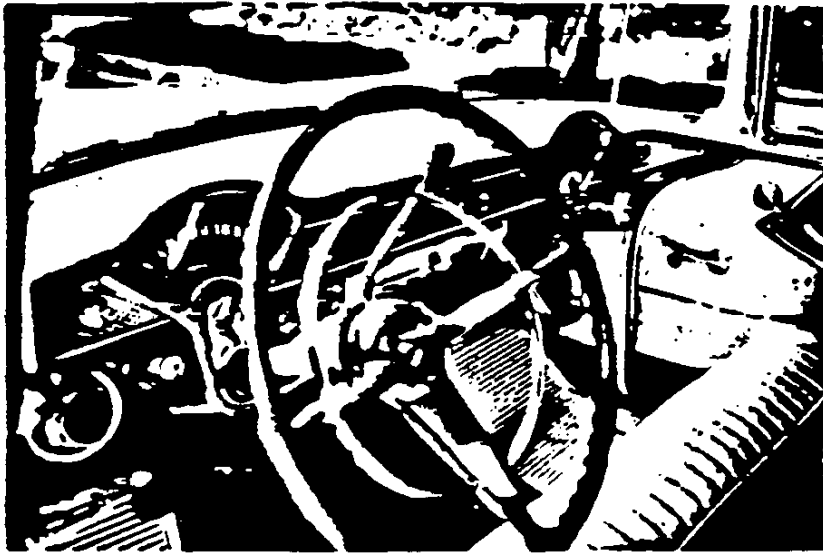

Among the most enduring of the extra-cost options is Air Conditioning, a feature first offered in the 1955 model. Engineered into the instrument panel, not merely suspended beneath it, it has continued to be one of the most popular luxury accessories.

The accessory Air Conditioner is fully installed behind the instrument panel and in the engine compartment. Its only evidence is the two adjustable vents placed at the ends of the instrument panel, and the control head which replaces the standard blanking plate (page 197).

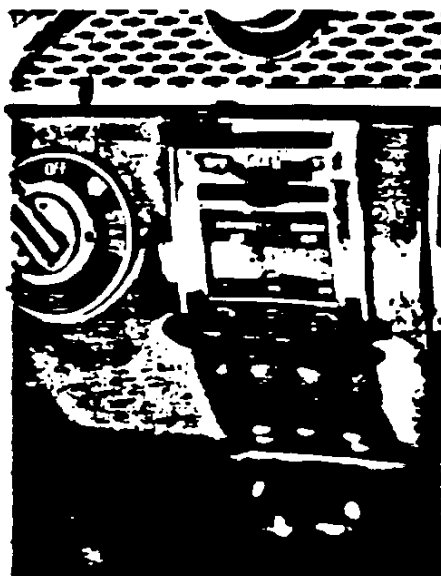



1955 Nomad



A split back front seat is hinged to allow access to the rear bench seat.



The headliner of the Nomad is held in place by seven chromed metal bows, five of which may be seen in this view.



The rear hatch of the Nomad, like other 2-door station wagons, can be folded for added cargo, but in this posi-

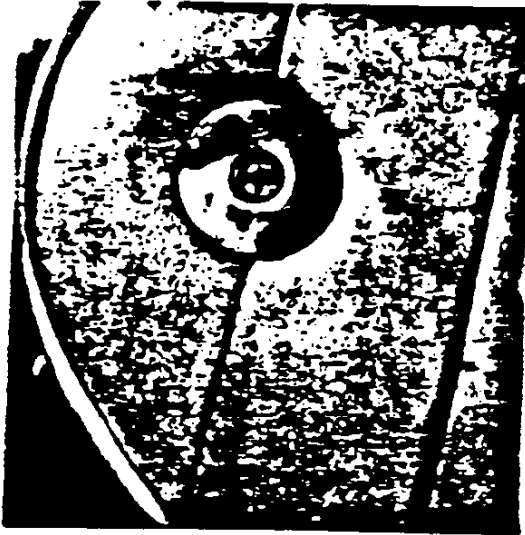

Special hardware at the tip of the folding rear seat back secures a latching mechanism.

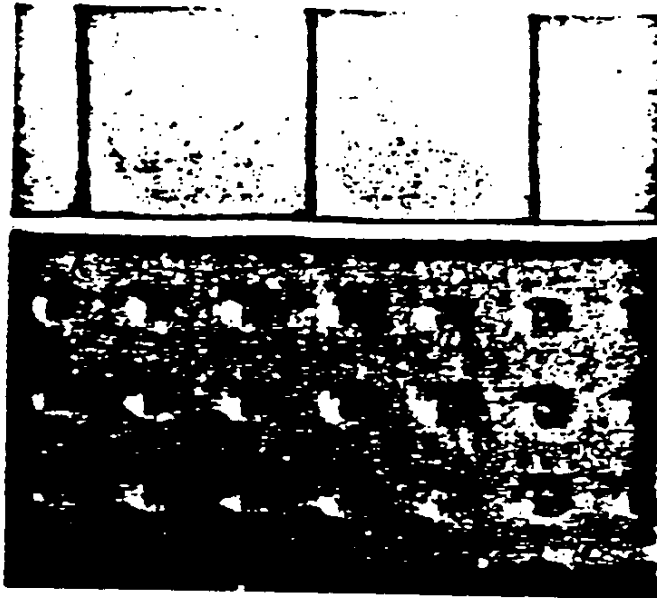

The distinctive Nomad vinyl waffle pattern upholstery is found in other models as well, notably the 1956/57 Corvettes.

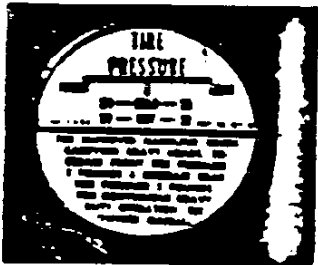

A tire pressure decal is placed on the edge of the door.

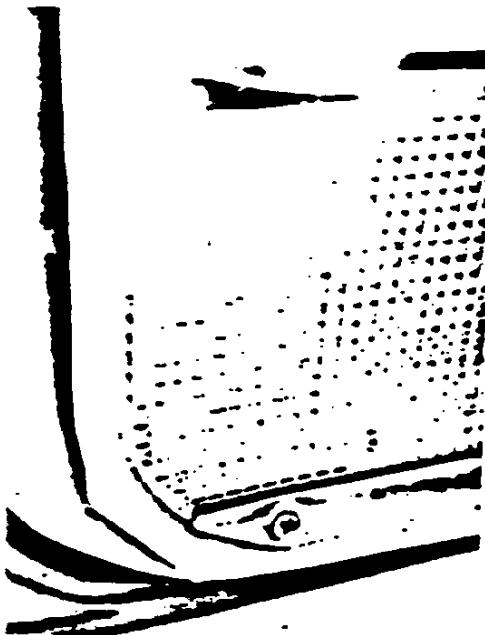

The bottom of the Nomad doors is protected by patterned metal scuff plates.



The narrow back pillars and abundantly curved quarter glass windows are distinctive to the Nomad.

1955 Nomad

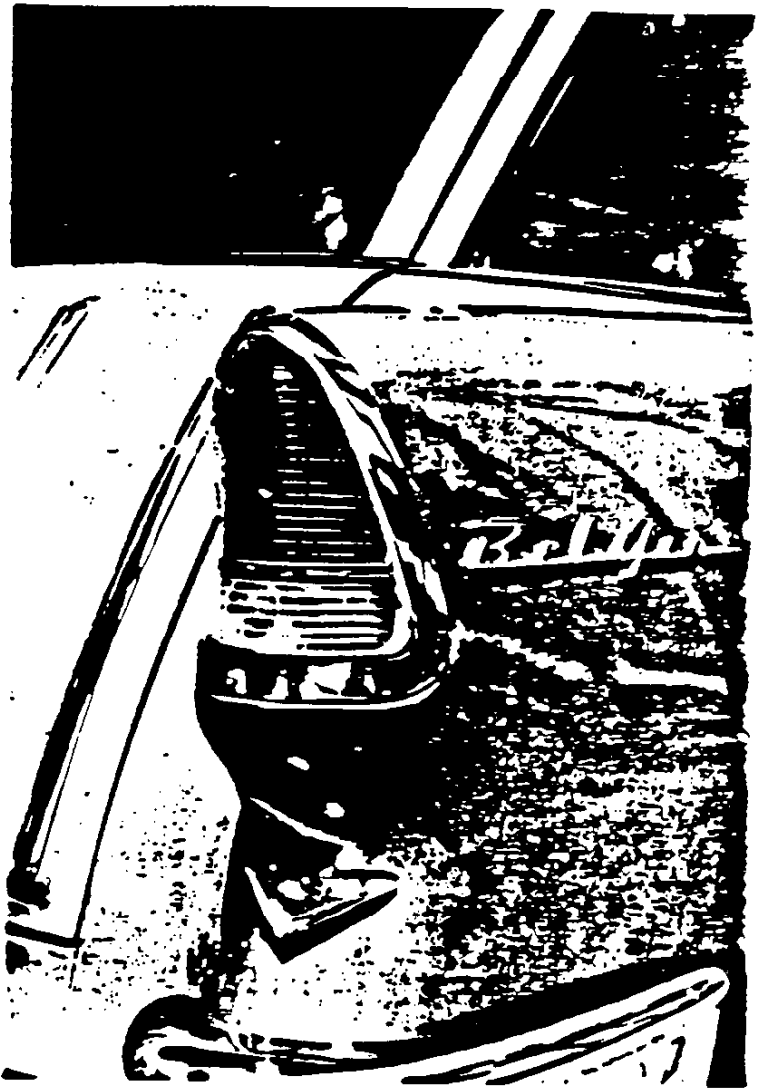

The Nomad shares the tail light design of the other 1955 models.



The Nomad appears longer than it actually is due to the extension of the rear fenders (and tail lights) beyond the tailgate.



The side trim includes the Bel Air script and familiar emblem (upper left).

1955 Nomad



rear end of the Nomad is unique in appearance. Featuring wrap-around windows, narrow pillars, emphatic stripes on the tailgate, it is unmistakable.



Seven bright metal trim stripes are used on Nomad models only.

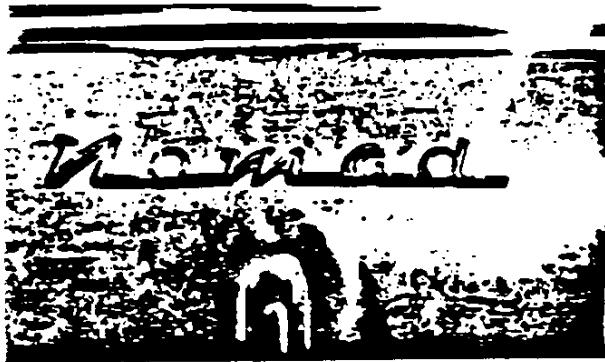

Nomad name appears on the tailgate just above the lock handle.



The tailgate latch is released by depressing the lockable push button. The back window ("lift gate") is hinged at its top and provided with telescoping supports (page 235).

1955 Nomad



Nomad, the highest priced model of Chevrolet's line, - was often furnished with added dress-up items. The front grill guard is one such an accessory.



Unique to the Nomad are the chromed trim pieces fitted over the headlamp housing.



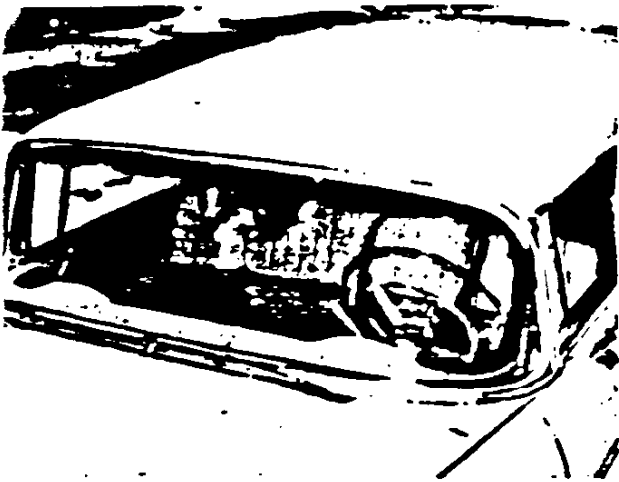

All-steel roof of the Nomad station wagon has distinctive curving "ribs" towards its rear.



The forward portion of the roof is smooth. Decorative transverse "ribs" run over the side above the quarter windows.



This graceful center pillar is unique to the Nomad.

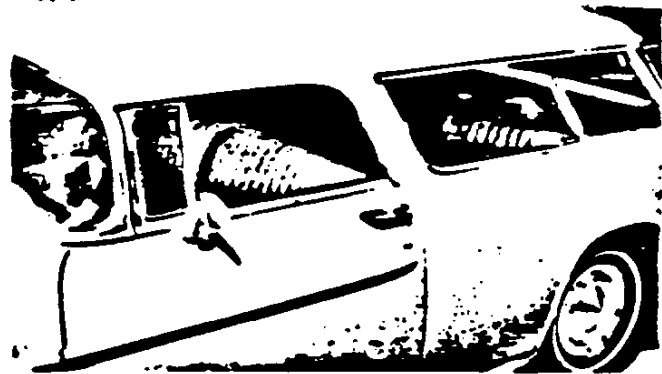

The front windows curve at their trailing edge to match the curve of the pillar.



Forward portion of the rear quarter window slides for ventilation.

Golden Chevy' possibly found

JAMES M. MILLER
Senior staff writer

The "golden Chevy" — one of the legendary collectible cars believed lost long ago — may have been found.

To celebrate its 50-millionth GM built a special gold-colored 1955 Chevrolet. The car's body and hundreds of fasteners were plated in real gold.

Photographers followed the special car as it was assembled. It was featured in a huge parade in Flint on Nov. 23, 1954.

Somehow, after all the hoopla, the car disappeared. Despite rumors that the car was stored in one of GM's warehouses, Chevrolet has no record of what happened to the car.

But it may not have been lost at all.

According to an article in the August issue of Special Interest Autos, the special Chevy was shipped south in 1957 and is now owned by a Chevrolet collector here.

The collector, who was not named by the magazine, was asked as saying the car is being

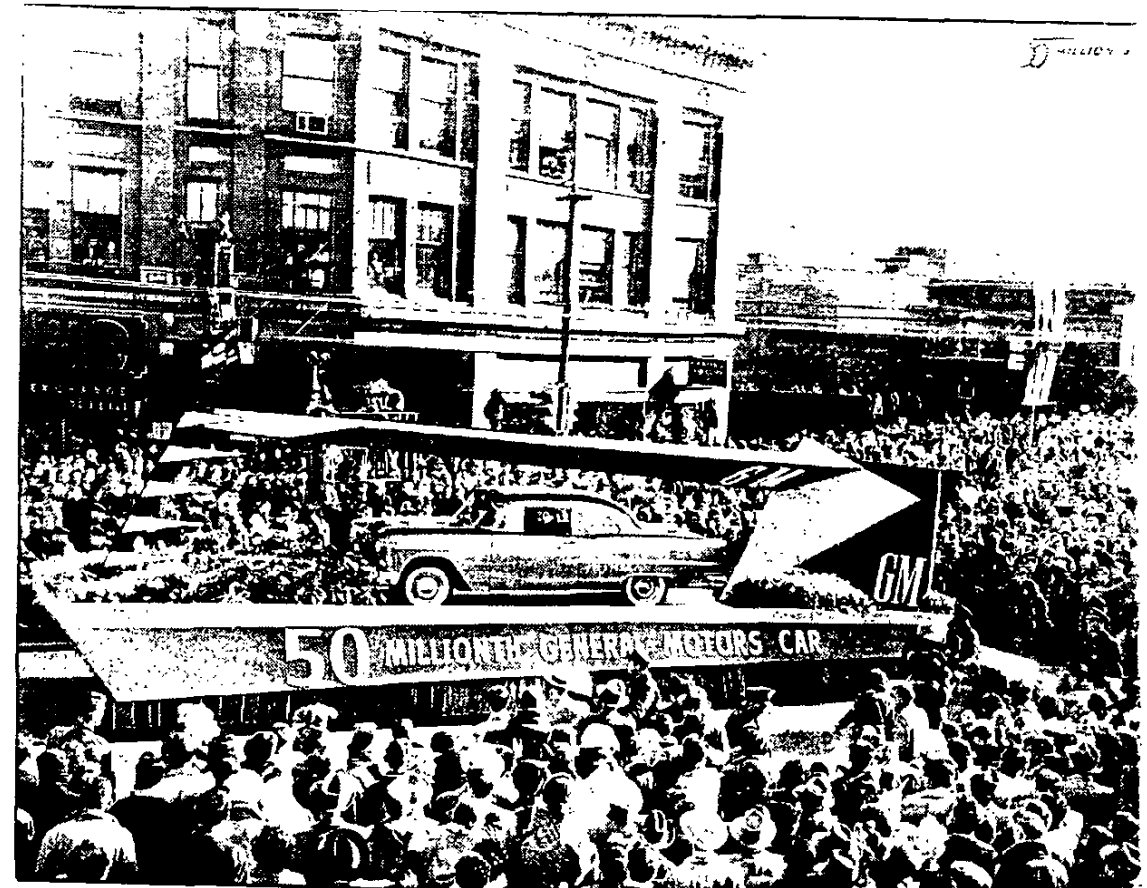

Thousands came to downtown Flint to see the 'golden Chevy' — GM's 50-millionth car.

restored, and its completion date will depend in part on the price of gold, since some of the trim needs to be plated.

The golden Chevrolet drew nationwide attention and even a letter of congratulation from President Dwight Eisenhower to GM President Harlow Curtice.

As production figures climbed toward 50 million, GM executives decided that the milestone car

would be a Chevrolet. Not just any Chevy, but a very special Flint-built Chevrolet, and the centerpiece for a big celebration.

According to Journal reports, the car was completed at 10:10 a.m., and factory whistles all around town screamed in unison to celebrate the occasion. The golden Chevy was immediately loaded on a float and towed to downtown Flint for the 11 a.m.

parade. The mile-long parade included 72 new vehicles, the 1908 Cadillac identified as the first GM car, other "milestone" cars, 18 floats and nine bands.

















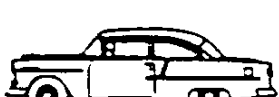
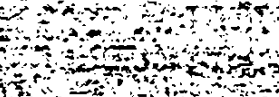
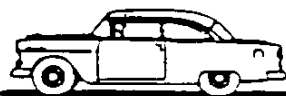

If the golden Chevy has truly been located, it would be a valuable car — but since it is one of a kind, the only way to determine its value would be to offer it for sale.

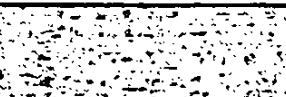
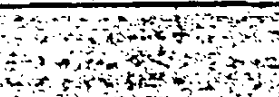
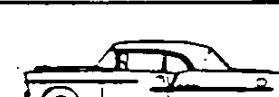

PASSENGER CARS

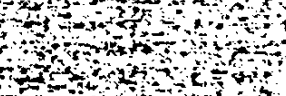
CHEVROLET 1955 SPECIFICATIONS

MODEL IDENTIFICATION

Name and Description	One-Fifty-Series 1500	Two-Ten-Series 2100	Bel Air-Series 2400
4-DOOR SEDAN 6-passenger, 7-window sedan with luggage compartment in rear			
MODEL	1503; 55-1219*	2103; 55-1019*	2403; 55-1019D*
2-DOOR SEDAN 6-passenger, 5-window sedan with luggage compartment in rear			
MODEL	1502; 55-1211*	2102; 55-1011*	2402; 55-1011D*
CLUB COUPE 6-passenger, 2-door, 5-window coupe with luggage compartment in rear			
MODEL		2124; 55-1011A*	
UTILITY SEDAN 3-passenger, 5-window sedan with luggage compartment in rear			
MODEL	1512; 55-1211B*		
SPORT COUPE 6-passenger, 2-door, 5-window coupe with hard top; luggage compartment in rear			
MODEL		2154; 55-1037D**	2454; 55-1037D*
CONVERTIBLE 5-passenger, 2-door, 5-window coupe with folding top; luggage compartment in rear			
MODEL			2434; 55-1067DTX*
STATION WAGON 6-passenger, 2-door, 5-window, all-steel body with drop and lift gates in rear			
MODEL	1529; 55-1263F*	2129; 55-1063F*	2429; 55-1064 DF**
STATION WAGON 6-passenger, 4-door, 7-window, all-steel body with drop and lift gates in rear			
MODEL		2109; 55-1062F*	2409; 55-1062DF*
SEDAN DELIVERY 2-passenger, 3-door, 3-window panel delivery			
MODEL	1508; 55-1271*		

* - Fisher body style number

** - Revised: 6-10-55, * - New Model added.

- MODEL IDENTIFICATION

SERIAL NUMBERS

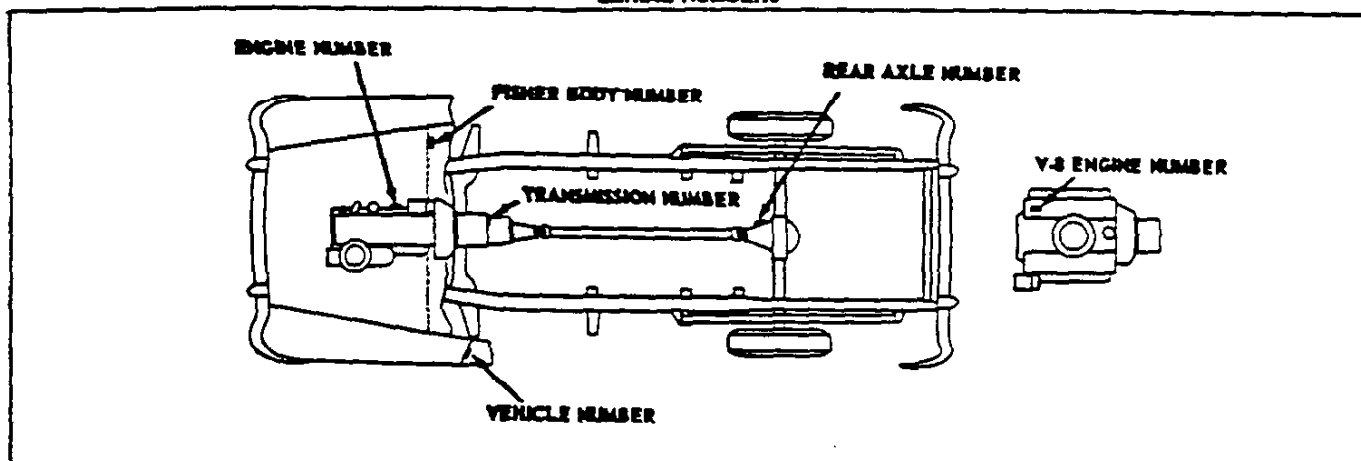

VEHICLE SERIAL NUMBER

Example: **A 55 T 001025**

Series	Model Year	Assembly Plant	Unit Number
--------	------------	----------------	-------------

With 6 cyl engine
 A "One-Fifty"
 B "Two-Ten"
 C Bel Air
 D Sedan Delivery

With 8 cyl engine
 VA "One-Fifty", except model 1508
 VB "Two-Ten"
 VC Bel Air

T-Tarrytown
 F-Flint
 S-St. Louis
 K-Kansas City
 O-Oakland
 A-Atlanta
 N-Norwood
 B-Baltimore
 L-Los Angeles
 J-Janesville

Starting unit number-----1001 and up, at each assembly plant regardless of series.
 Location-----Stamped on plate attached to left front body hinge pillar.

ENGINE SERIAL NUMBER

Example: **001001 F 55 Z**

Unit Number	Plant Designation	Model Year	Type Designation
-------------	-------------------	------------	------------------

Plant: T-Tonawanda; F-Flint
 Type:

6-Cyl Z - Regular Engine
 ZC - RPO 227 (HD clutch) or RPO 330 (Taxicabs with HD clutch)
 ZH - RPO 219A (For fleet users; aluminum camshaft gear)
 ZJ - RPO 219B (For fleet users; aluminum camshaft gear and HD clutch)
 Y/- RPO 313 (Automatic transmission)

8-Cyl F - RPO 223 (8 cylinder with auto. trans.)
 FB - RPO 410 (8 cylinder with auto. trans.)
 FC - RPO 450 (8 cylinder with auto. trans.)
 eFD - RPO 410 (8 cylinder with automatic transmission and air conditioning)
 G - RPO 221 (8 cyl with 3-Speed trans.)
 GC - RPO 222 (8 cyl with overdrive trans.)
 GD - RPO 410 (8 cyl with 3-Speed trans.)
 GF - RPO 450 (8 cyl with 3-Speed trans.)
 eGG - RPO 410 (8 cyl with 3-Speed transmission and air conditioning)
 GJ - RPO 227 (8 cyl with HD clutch & 3-Spd trans)

8-Cyl GK - RPO 450 (8 cyl with HD clutch & 3-Spd trans)
 GL - RPO 410 (8 cylinder with HD clutch and 3-Speed transmission)
 GM - RPO 410 (8 cyl with HD clutch, air conditioning and 3-Speed transmission)
 eGL - RPO 410 & 411 (8 cyl with Overdrive)
 eGM - RPO 410 & 411 (8 cyl with Overdrive and Air Conditioning)
 eGQ - RPO 450 (8 cyl with Overdrive)

Starting unit number (6 & 8 Cyl engines are numbered separately) starting with 1001 and up, at each engine plant.
 Location: 6 Cylinder ----- Stamped on pad on right hand side of cylinder block at rear of distributor
 8 Cylinder ----- Stamped on pad at front right hand side of cylinder block

TRANSMISSION IDENTIFICATION

Example: **M 11 26**

Plant & type desig. Prefix	Month	Day of Month
----------------------------	-------	--------------

M Muncie 3-Speed *
 S Saginaw 3-Speed *
 C Cleveland Powerglide

Location: Conventional----- Stamped on rear face of case in the upper right hand corner
 Powerglide----- Stamped on rear face of case in the lower right corner.
 *-Overdrive-----Have the same identification as the conventional 3-speed trans; the difference being distinguished by physical appearance.

REAR AXLE SERIAL NUMBER

Example: **BB 212**

Plant & Type Designation	Unit Number
Plant	Type

Buffalo
 AA BA 3-Speed
 AB BB Powerglide
 AC BC 3-Speed, Overdrive

Unit number-----The first one of two digits represent the month; the last two, the day of the month
 Location-----Stamped on fr, right side of differential carrier

FISHER BODY NUMBER

Description----- Consists of separate numbers and symbols for body style, body number, trim type, and paint combination. Controlled by body source.
 Location-----Stamped on plate on right hand shoulder of cowl, under the hood.

VEHICLE WEIGHTS † † * *

1500 SERIES

VEHICLE TYPE	SHIPPING WEIGHT			CURB WEIGHT			LOADED WEIGHT		
	Total	Front	Rear	Total	Front	Rear	Total	Front	Rear
Description									
P 2-Door Sedan	3205	1770	1435	3335	1805	1530	4235	2130	2105
	3110	1695	1415	3240	1730	1510	4140	2055	2085
P 4-Door Sedan	3260	1780	1480	3390	1815	1575	4290	2140	2150
	3165	1705	1460	3295	1740	1555	4195	2065	2130
P Sedan Delivery	3205	1725	1480	3335	1760	1575	4000	1765	2235
	3110	1650	1460	3240	1685	1555	4000	1695	2305
P Utility Sedan	3180	1780	1400	3310	1815	1495	3760	2065	1695
	3085	1705	1380	3215	1740	1475	3665	1990	1675
P 2-Door Station Wagon	3385	1765	1620	3515	1800	1715	4415	2100	2315
	3290	1690	1600	3420	1725	1695	4320	2025	2295

2100 SERIES

P 2-Door Sedan	3240	1770	1470	3370	1805	1565	4270	2130	2140
	3145	1695	1450	3275	1730	1545	4175	2155	2120
P 4-Door Sedan	3275	1780	1495	3405	1815	1590	4305	2140	2165
	3180	1705	1475	3310	1740	1570	4210	2065	2145
P 4-Door Station Wagon	3465	1760	1705	3595	1795	1800	4495	2095	2400
	3370	1685	1685	3500	1720	1780	4400	2020	2380
P Club Coupe	3240	1775	1465	3370	1810	1560	4270	2135	2135
	3145	1700	1445	3275	1735	1540	4175	2060	2115
P 2-Door Station Wagon	3425	1755	1670	3555	1790	1765	4455	2090	2365
	3330	1680	1650	3460	1715	1745	4360	2015	2345
P Sport Coupe	3280	1780	1500	3410	1815	1595	4310	2150	2160
	3185	1705	1480	3315	1740	1575	4215	2075	2140

2400 SERIES

P 2-Door Sedan	3250	1780	1470	3380	1815	1565	4280	2140	2140
	3155	1705	1450	3285	1740	1545	4185	2065	2120
P 4-Door Sedan	3295	1790	1505	3425	1825	1600	4325	2150	2175
	3200	1715	1485	3330	1750	1580	4320	2075	2155
P 4-Door Station Wagon	3480	1775	1705	3610	1810	1800	4510	2095	2415
	3385	1700	1685	3515	1735	1780	4415	2020	2395
P 2-Door Station Wagon	3460	1780	1680	3590	1805	1785	4490	2090	2400
	3365	1705	1660	3495	1730	1765	4395	2015	2380
P Convertible	3410	1855	1555	3540	1890	1650	4290	2190	2100
	3315	1780	1535	3445	1815	1630	4195	2115	2080
P Sport Coupe	3290	1785	1505	3420	1820	1600	4320	2155	2165
	3195	1710	1485	3325	1745	1580	4225	2080	2145

SHIPPING WEIGHT: This is the weight of the basic vehicle with all regular equipment and with grease and oil level as required. It does not include the weight of gasoline and water.

LOADED WEIGHT: This is the curb weight of the basic vehicle plus 150 pounds for each passenger.

VEHICLE WEIGHT: This is the weight of the empty vehicle to drive. It is the shipping weight plus the weight of gasoline (97 pounds) and water (33 pounds).

PERFORMANCE WEIGHT: This is the curb weight of the lowest price 4-Door Sedan with regular equipment plus 600 pounds for passengers. A representative example is:
Model 1503 ----- 3895

For V-Eight engine option, deduct 30 pounds from total and front.

Models equipped with automatic transmissions are designated with the letter "P". Example: 1503P

Weights shown are official production weights and replace weights shown on sheet dated 10-29-54, which were estimated weights. Weights shown for 2154 are estimated weights.

EXTERIOR DIMENSIONS

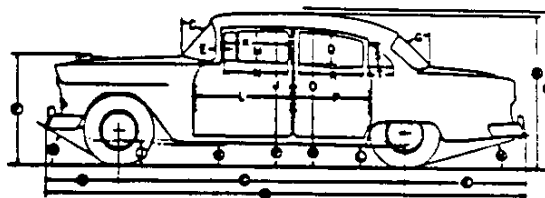
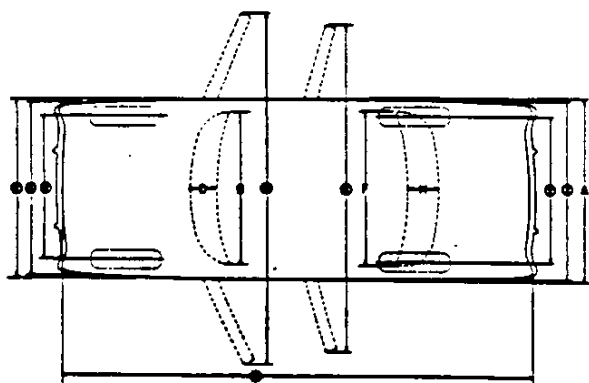

DESCRIPTION		KEY	1502	1503	1529	2109	2434	2154*	1508	2429*
			1512	2102	2103	2129	2409	2454		
Vehicle length	Overall	⊗	195.6		197.1		195.6		197.1	
	Overall less bumpers	⊗			188.3					
	Wheelbase	⊙			115.0					
	Front overhang	⊙			31.1					
	Rear overhang	⊙	49.5		51.0		49.5		51.0	
Vehicle height	Over ornament	⊗*			43.0					
	Over roof, loaded	⊗*	60.5		60.8		59.1 ▽		60.8 59.4	
	Over roof, unloaded	⊗⊕			62.1		60.4 ▽		62.1 60.7	
Road clearance	Under front susp X-member	⊙ ‡			8.1					
	Under exhaust pipe	⊙ ‡			6.5					
	Under rear axle center	⊙ ‡			8.0					
Angle of approach	⊗			28.4°						
Angle of departure	⊗	16.0°		15.9°		16.0°		15.9°		
Door step height	Front door	⊗⊕	13.5	14.5		15.0	13.5			
	Rear door	⊗⊕		14.5		15.5				
Vehicle width	Over front bumper	⊙			72.5					
	Over front fenders	⊙			73.4					
	Front wheel tread	⊙			58.0					
	Over front doors, open	⊙	153.0	140.7	153.0	137.5	153.3	151.5	153.0	
	Over rear doors, open	⊙		125.5		124.7				
	Rear wheel tread	⊙			58.8					
	Over rear bumper	⊙			72.0					
Windshield	Over body maximum	A			74.0					
	Width	B			58.5					
	Slope Angle	C			41.9°					
	Height on slope	D			17.5		16.8		17.5 16.8	
	Corner post (blind spot)	E			3.8					
Rear window	Width	F	57.5		41.0	46.3	58.8	41.0	41.8	
	Slope angle	G	47.0°		31.3°	46.0°	41.0°		31.3°	
	Height on slope	H	18.3		13.6	16.5	17.0	13.6	15.5	
Front door	Opening height	J		42.0		40.0		42.0	41.5	
	Opening width, above belt	K	34.0	28.0	34.0	28.0	32.0		34.0	
	Opening width, below belt	L	43.8	37.0	43.8	37.0	43.0		43.8	
	Window DLO height	M			13.0					
	Window DLO width	N	11.3	25.5	31.3	25.5	30.5	31.3	9	
Rear side door	Opening height	O		41.0		41.0				
	Opening width	P		27.5		27.5				
	Window DLO height	Q		13.3		13.3				
	Window DLO width	R		25.5		25.5				
Rear quarter	Window DLO height	S	13.0	9.0	13.0	13.3	13.5		12.3	
	Window DLO width	T	33.5	10.6	69.8	45.8	19.1	24.8		9

* - Under design load conditions ⊗ - At curb weight

‡ - Road clearance based on static conditions of tires and springs under design load

▽ - Convertible height, top down (measured from W/S header bar) 55.5 design load; 56.8 unloaded

10-29-54. Revised: 6-10-55. * - New model added. 9 - Information not available.

CHEVROLET 1955 SPECIFICATIONS - PASSENGER

BODY INTERIOR DIMENSIONS

Trim and hardware differences between One-Fifty, Two-Ten, and Bel Air models are not considered in these dimensions. However, these differences are never greater than 5/8.

1900-2100-2400
4-DOOR SEDAN

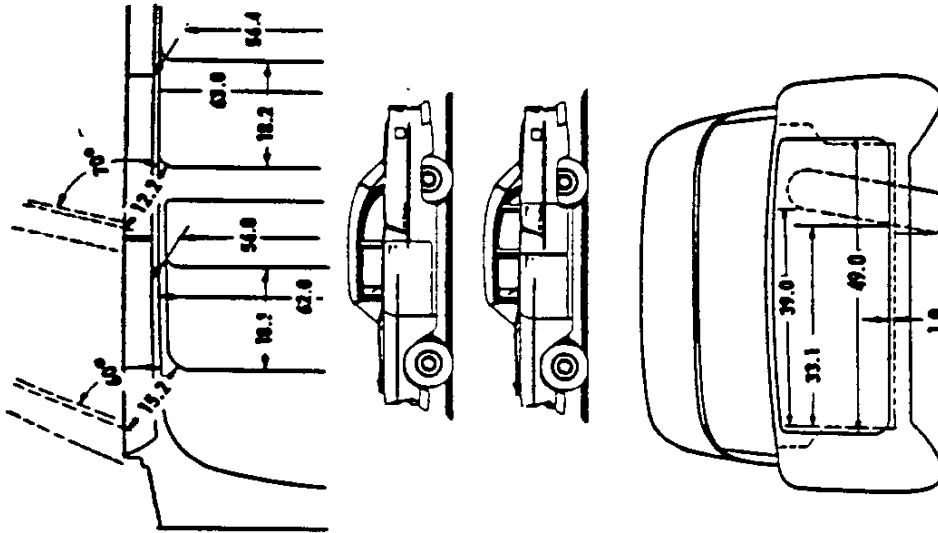

LUGGAGE COMPARTMENT APPROXIMATE
CAPACITY IS 20 CU. FT. WITH
SPARE TIRE INSTALLED

1602 - 2102 - 2124 - 2402
2-DOOR SEDAN

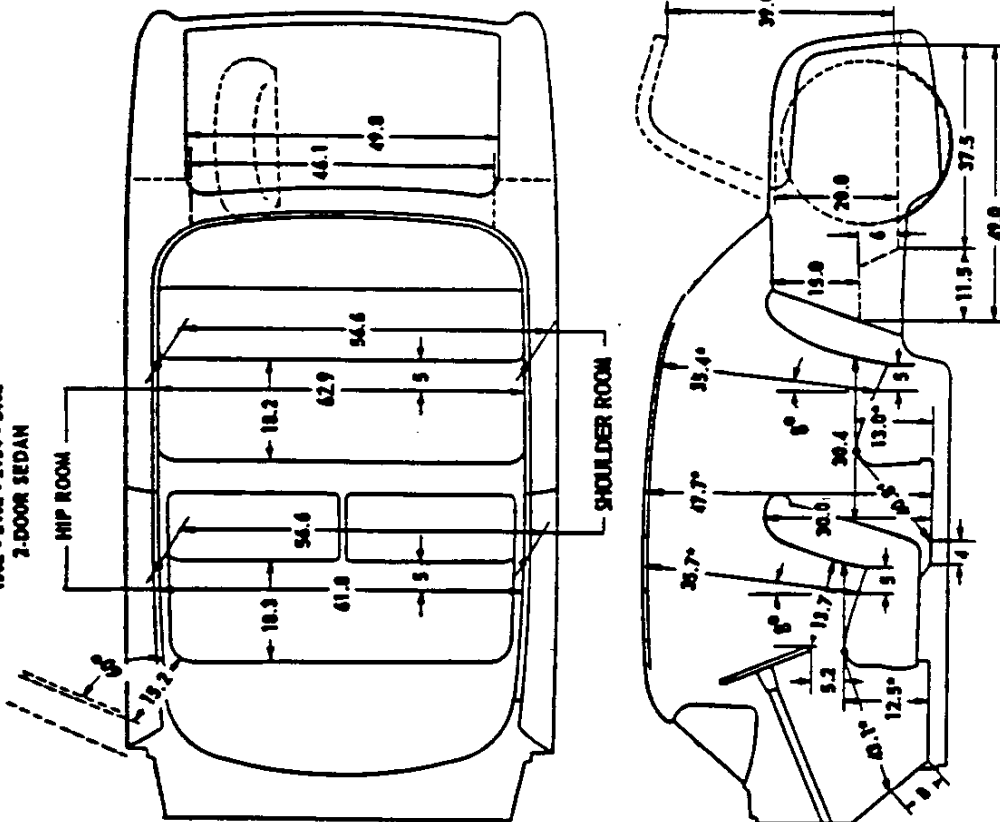

FRONT SEAT ADJUSTMENT 4.4 SEAT SHOWN IN REAR POSITION
• - MEASURED 15 FROM CENTER OF CAR

BEL AIR 2 - DOOR AND 4 - DOOR SEDANS (MODELS 2402 AND 2403)
TWO-TEN 2 - DOOR AND 4 - DOOR SEDANS (MODELS 2102 AND 2103)
TWO-TEN CLUB COUPE (MODEL 2124)
ONE-FIFTY 2 - DOOR AND 4 - DOOR SEDANS (MODELS 1502 AND 1503)

BODY INTERIOR DIMENSIONS - Continued

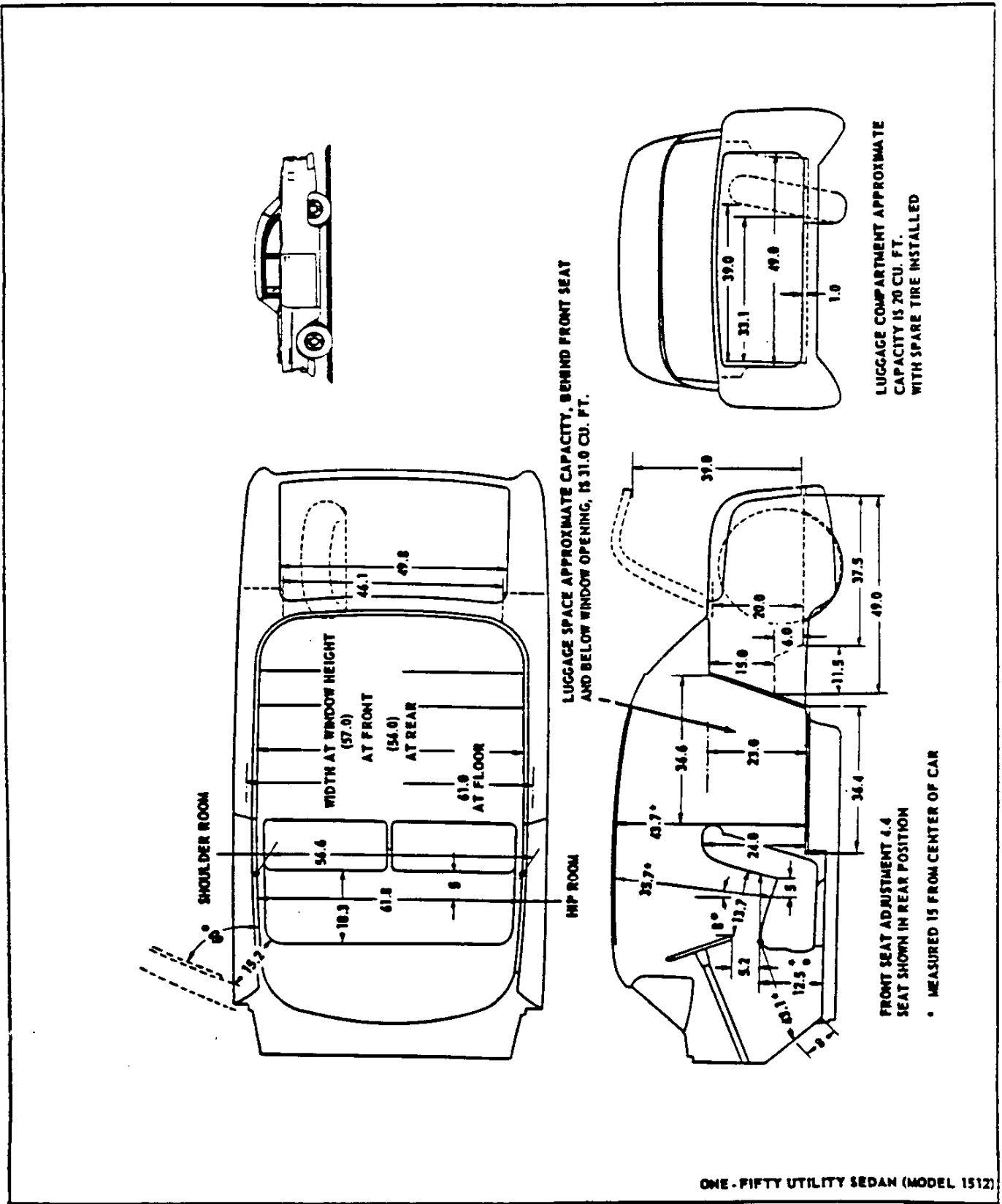

CONTINUED

BODY INTERIOR DIMENSIONS - CONTINUED

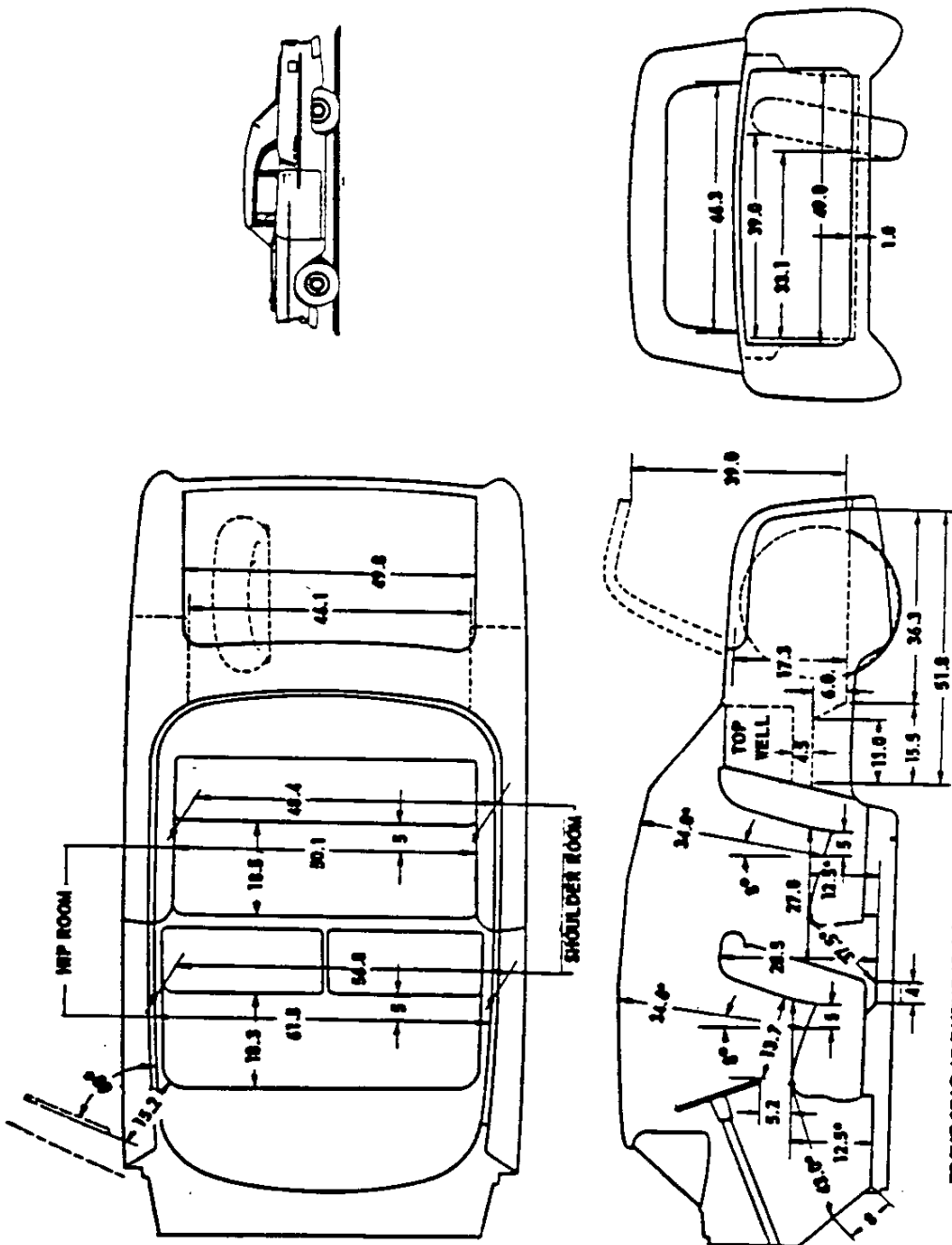

LUGGAGE COMPARTMENT APPROXIMATE CAPACITY IS 17 CU. FT. WITH SPARE TIRE INSTALLED.

FRONT SEAT ADJUSTMENT 4.1" SEAT SHOWN IN REAR POSITION
 ° - MEASURED 15 FROM CENTER OF CAR

BEL AIR CONVERTIBLE (MODEL 2434)

CONTINUED

BODY INTERIOR DIMENSIONS - CONTINUED

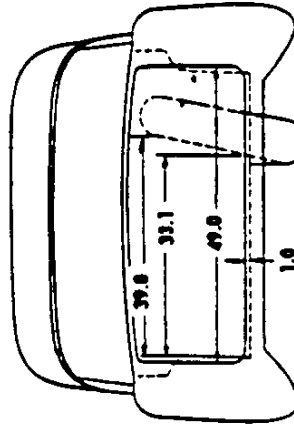
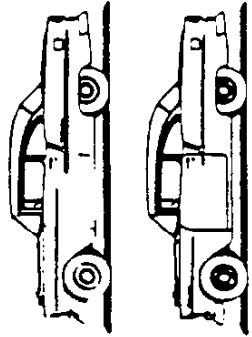

LUGGAGE COMPARTMENT APPROXIMATE CAPACITY IS 20 CU. FT. WITH SPARE TIRE INSTALLED.

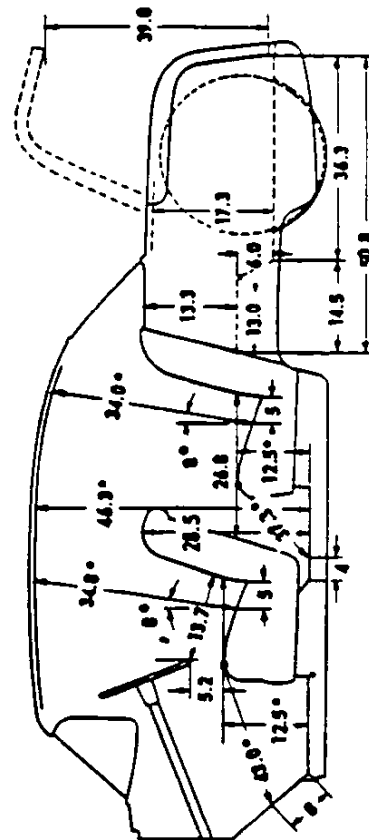
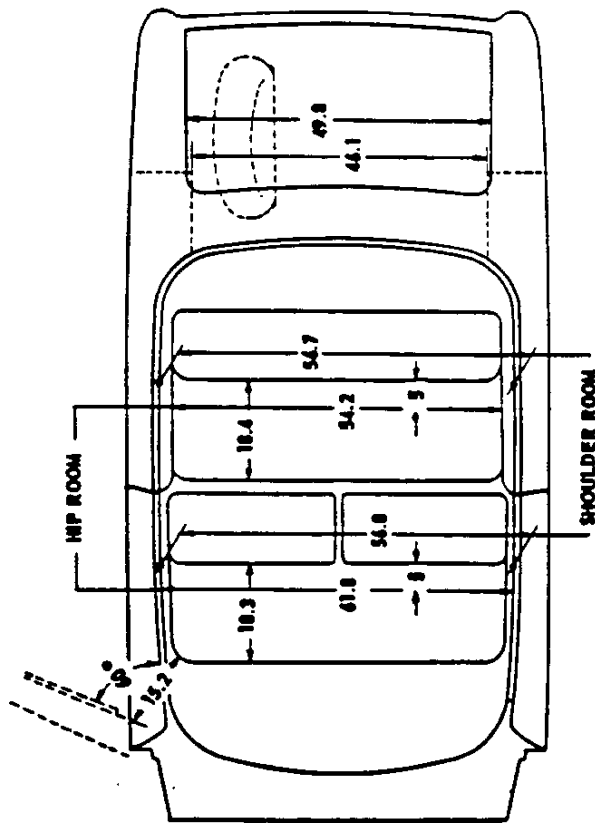

FRONT SEAT ADJUSTMENT 4.4 SEAT SHOWN IN REAR POSITION
 ° - MEASURED 15 FROM CENTER OF CAR

° TWO-TEN SPORT COUPE (MODEL 2154)
 BEL AIR SPORT COUPE (MODEL 2454)

CONTINUED

BODY INTERIOR DIMENSIONS - CONTINUED

Trim and hardware differences between One-Fifty, Two-Ten, and Bel Air models are not considered in these dimensions. However, these differences are never greater than 5/8.

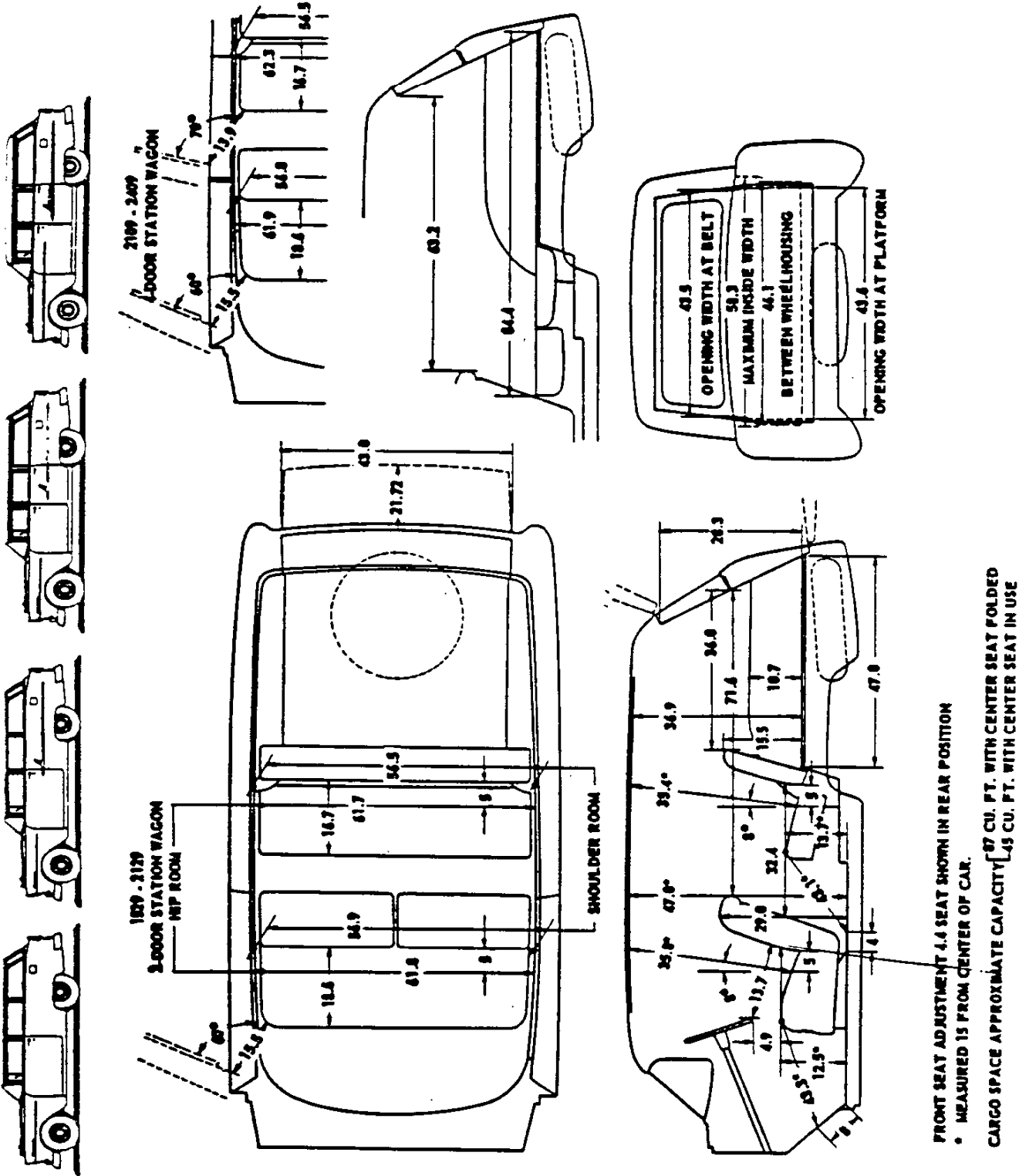

BEL AIR 4-DOOR STATION WAGON (MODEL 2109)
 TWO-TEN 2-DOOR AND 4-DOOR STATION WAGONS (MODELS 2129 AND 2109)
 ONE-FIFTY 2-DOOR STATION WAGON (MODEL 1529)

FRONT SEAT ADJUSTMENT 4.4 SEAT SHOWN IN REAR POSITION
 * MEASURED 15 FROM CENTER OF CAR.
 CARGO SPACE APPROXIMATE CAPACITY 87 CU. FT. WITH CENTER SEAT FOLDED
 45 CU. FT. WITH CENTER SEAT IN USE

CONTINUED

1-29-54. Revised: 6-10-55, e-Dimension lines corrected.
 - BODY INTERIOR DIMENSIONS

CHEVROLET 1955 SPECIFICATIONS - PASSENGER

BODY INTERIOR DIMENSIONS - Continued

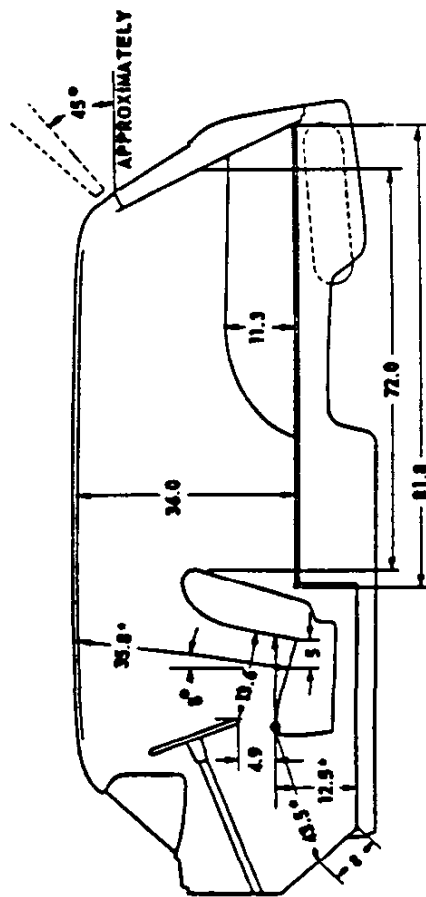
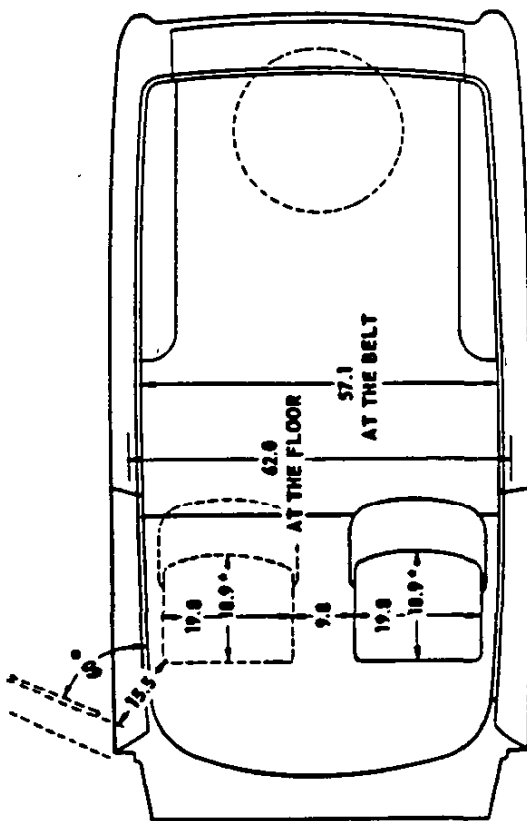
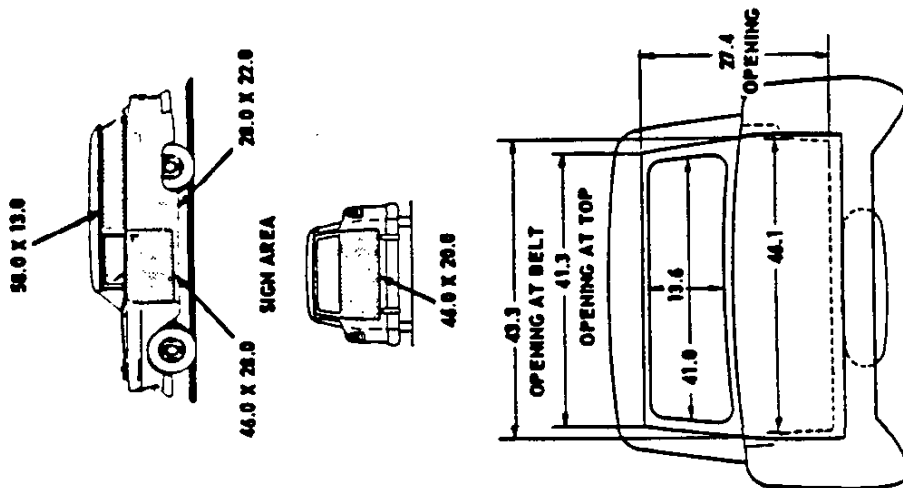

LOAD SPACE APPROXIMATE CAPACITY IS 91 CU. FT.

FRONT SEAT ADJUSTMENT 40 SEAT SHOWN IN REAR POSITION
 ° - MEASURED 15 FROM CENTER OF CAR

ONE-FIFTY SEDAN DELIVERY (MODEL 1508)

BODY INTERIOR DIMENSIONS •

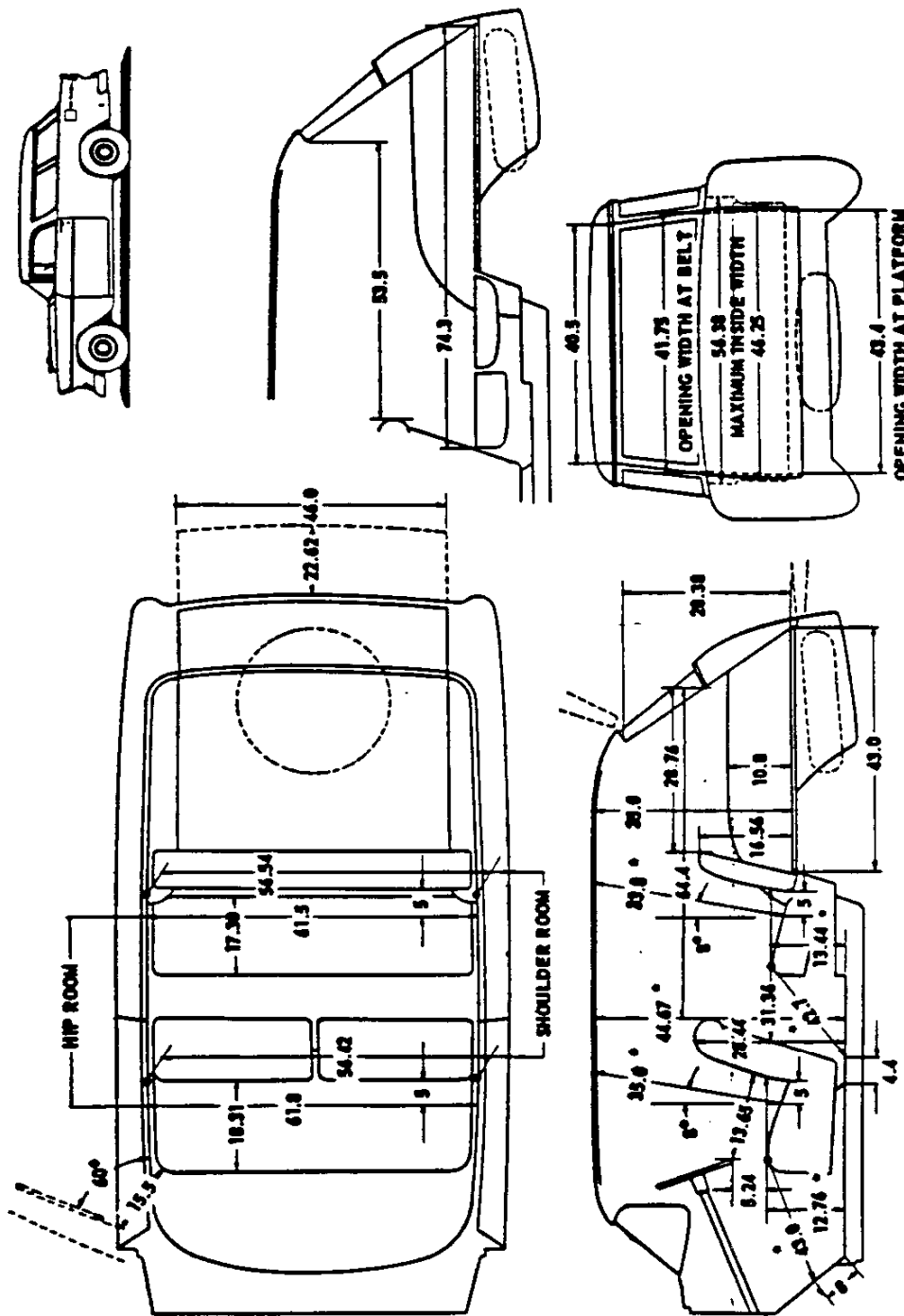

APPROXIMATE CARGO SPACE CAPACITY [71 CU. FT. WITH CENTER SEAT DOWN] [36.0 CU. FT. WITH CENTER SEAT UP]

• - MEASURED 15 FROM C OF CAR

FRONT SEAT ADJUSTMENT 4.4 (SEAT SHOWN IN REAR POSITION)

BEL AIR 2-DOOR NOMAD STATION WAGON (MODEL 2429)

ACCESSORIES

Definition: Items made available at extra cost through the Parts and Accessories Department and installed by the customer, or his dealer, unless otherwise indicated.

ITEM		MODEL
Alarm	Parking brake	All
Arm rests	Door, front and/or rear	1500
Ash tray	Instrument panel	All
Blade	Windshield Wiper (De-icing)	All
Block	Wiring junction	All
Cap	Hub (Full disk)	1500-2100
	Gasoline tank filler locking	All
Carrier	Wheel (continental type)	All except 1508-29; 2109-29; 2409-29x
Clock	Instrument panel (electric)	1500-2100
Compass	Illuminated	All
Cover	Accelerator pedal	
	Seat & back	Plastic
		Nylon
		Fiber
Seat only	Nylon	All except 1508-29; 2109-29; 2409-29x
Deflector	Rain	Front & rear doors
		Front doors & rear quarter windows
		1503; 2103; 2403
		1502-12; 2102-24; 2402
Dispenser	Tissue	
Extension	Muffler tail pipe	
Filter	Water (cooling system)	All
Frame	License plate	
Guard	Grille (on bumper)	
	Fender (on front & rear bumpers)	
	Door edge	All except 1529; 2109-29; 2409-29x
	Gasoline tank filler door	
Heater & Defroster*	Recirculating	
	Air-flow	
Lamp	Back-up pair (with conventional or auto transmission)	All
	Lighter, cigarette	
	Courtesy	All except 2434
	Luggage Compartment	All except 1508-29; 2109-29; 2409-29x
	Under hood	
	Portable spot (plugs in cigarette lighter)	All
	Spot, LH; Guide (with bracket & mirror)	
	Glove compartment	1500
Lighter	Cigarette	
Mat	Floor (blue, red, green, black, brown)	All
Mirror	Rear view	Door, remote-control
		Door, body mount
		Inside, non-glare
	Visor, vanity	All
Molding	Wheel (stainless steel)	1500-2100
	Body sill	
Radio	Manual tuning (Delco)	
	Push-button tuning (Delco)	All
	Signal seeking (Delco)	
	Antenna (on RH fender)	
	Speaker, auxiliary (rear seat)	All except 1508-29; 2109-29; 2409-34
Reflector	Reflex (red)	
Pad	Ventilated seat	
Shaver	Electric	All
Shield	Door handle (on door)	
	Front fender (pair)	
	Windshield glare	
Signal	Direction (self-cancelling)	
Sunshade	Right hand	1500
Sun visor	Outside type	All except 2434-29x
Tool kit	Bag with tools	All
Top lift	Automatic (moisture-sensitive)	2434 only
Viewer	Traffic light	
Washer	Windshield (foot or vacuum-operated)	All
	Co-ordinator (automatic wiper & washer action)	

* - Factory optional accessory but can be purchased through dealer.

† - Factory optional accessory only.

10-29-54. Revised:6-10-55.©- Data added. x - Data revised.

REGULAR PRODUCTION OPTIONS *

Definition: Items released by the Engineering Department for installation at the assembly plant at the customer's request in addition to or in place of regular equipment, and usually at extra cost.

RPO	ITEM	Weight, Added (lbs)#
216	Oil bath air cleaner; 1 pint capacity	*
219	Aluminum camshaft gear	*
221	8 Cylinder engine with 3-Speed transmission	Minus 26.57 Front
222	8 Cylinder engine with Overdrive transmission	Minus 27.09 Front
223	8 Cylinder engine with Automatic transmission	Minus 84.45 Front
227	Heavy Duty Clutch	*
231	Color combinations	*
235	Color combinations (Solid color)	*
236	Color & trim combinations	*
237	Oil filter, 1 quart capacity	9.61
238	Color & trim combinations	*
239	Color & trim combinations	*
241	Governor	*
246	Color combinations (Two-tone)	*
247	Color combinations (Special Two-tone)	*
254	Heavy duty rear spring	19.31
263	Auxiliary seat	43.00
288	6.70-15-6 ply tires, Black wall & white & blackwall	13.45
290	6.70-15-4 ply tires, White & blackwall	*
313	Automatic transmission (Powerglide)	157.40
315	Overdrive transmission	30.00
320	Electric windshield wipers	*
324	Hydraulic steering	*
325	Generator	28.81
	30 Amp	
	40 Amp low cut-in	
330	Taxi Cab - Cloth & leather interior trim with conventional or Powerglide transmission. Also includes the following features: Black, green, blue & brown rubber floor mats with special water resistant floor covering front & rear; arm rest door pull handles on rear doors; heavy duty front & rear seat cushion & back spring; automatic dome light switch operated by right hand rear door.	18.62
345	Heavy Duty Battery	10.78
397	Electric seat & window control	31.97
398	Body glass (Tinted)	*
406	Front Stabilizer (Police Cars)	17.54
410	Power package (8 cylinder engine)	44.79
411	Four Barrel Carburetor	17.70
412	Vacuum power brakes	15.57
417	Engine positive ventilation	*
435	Trim combination (Body)	*
436	Trim combination (Body)	*
437	Color & trim combinations (Solid color)	*
441	Color & trim combinations (Two-tone)	*
442	Color & trim combinations (Two-tone)	*
450	Air conditioning	162.26

- Figures shown are maximum weights taken from the RPO Weight List for each RPO number. For distribution of weight on front and rear or for further information on model usage for each option, see RPO Weight List. For information on tire RPO's see page 53.

* - Weight is less than 10 pounds.

REGULAR EQUIPMENT

	ITEM	MODELS
Exterior	Bumpers & dual bumper guards, front and rear	All
	Bright metal headlights rims	
	Dual parking lights	
	Hood ornament and emblem	
	Dual windshield wipers	
	Dual horns	
	Outside key locks, both front doors below handles	
	Wheel disks	
	Hub caps	
	Concealed gasoline filler cap	
	Rear deck lid emblem with finger grip	All except 1508-29; 2109-29; 2409-29
	Push button tailgate handle	
	Dual tail and stop lights with provisions for back-up lights	2429x
	Rear license plate lights in bumper guards	All
	Push button side door handles	
	Outside rear window mirror	

Continued

10-29-54. Revised: 6-10-55. * - RPO list revised. x - Equipment added for Model 2429.

REGULAR EQUIPMENT - Continued

		ITEM	MODELS	
Exterior	Bright metal molding	Body belt	2109-29; 2409	
		Roof header		
		Front fender (painted insert on 2429)	2400	
		Rear fender (painted insert on 2400)	2100, 2400 except 2429*	
		Sash molding	2102-03-24-54; 2402-03-34-54*	
		Wing molding	2109-29; 2409	
		Fender hood molding	2429	
		W/S pillar	2400	
		Saddle molding	2154, 2434-54*	
		Tail gate vertical moldings	2429	
		Bright metal lift gate frame	2429	
		Reveals	2100, 2400	
			Windshield	2102-03-24-54; 2402-03-29-34-54*
			Side window	
			Rear window	2100, 2400 except 2434
			Series nameplate on rear quarter panel	2400
			Name on front fender	1500, 2100
	V-emblem below each tail light (8 cylinder)	All*		
	Bonderized body and sheet metal			
Interior	Instrument panel	Two-tone finish	All	
		Bright metal cluster bezel		
		Bright metal insert	2400	
		Glove compartment	Lock Automatic light	All
		Ash tray		2100, 2400
		Cigarette lighter		
		Electric clock		2400
		Crash pad		
		3-position ignition lock and starter switch		
		Script on radio grille, "Chevrolet" 1500 & 2100; "Bel Air" 2400		All
		Steering wheel	Two spoke	
	Three spoke			2400
	Horn blowing ring			2100, 2400
	Horn button			1500
	Emblem on steering wheel hub (Gold plated on 2400; bright metal, others)			2100, 2400 (V-type when equip with V-8 engine)
		Dual ventilators in cowl side panels		All
	Sunshades	Dual		2100, 2400
		Left hand only		1500
		Inside rear view mirror		All except 1508
		Foam rubber seat cushion pads, front and rear		2400, except 2409*
		Foam rubber seat cushion pads, front only		2100
		Arm rests, front and rear doors or quarter panels		21-2400 Front only on 2109-29; 2409-29
		Assist straps		2102-24; 2402
		Coat hooks		2100, 2400 except 2129 and 2434
		Rear compartment ash tray	In front seat back In arm rests	2103, 2403 2102-24-54; 2402-34-54*
		Package shelf		All except 1508-29; 2109-29; 2409-29-34*
		Scuff pads on doors and/or quarter panels		All
		Passenger compartment lights		1, all except 2 on 2434-29-54*
		Automatic door switch	Front doors only All doors	2100, 2400 2400
		Manual compartment light switch integral with headlamp switch (Main switch)		All
		Manual compartment light switch at tailgate		2429
		Rolled embossed aluminum step plates with "Body by Fisher" emblem		All
		Extra roof insulation		2100, 2400 except 2434
		Crank-type ventipanes with bright metal frames		All
		Adjustable front seat		
		Bright metal moldings	Windshield garnish	2434
			Roof rail and side window garnish	2429 & 2454*
			On seat scuff pads & side trim scuff pads	2100, 2400
			Roof bows	2429 & 2459*
			Rear window garnish	

10-29-54. Revised: 6-10-55. * - Data revised.

CHEVROLET 1955 SPECIFICATIONS - PASSENGER

REGULAR EQUIPMENT - 21

● EXTERIOR - INTERIOR COLOR COMBINATIONS

ONE COLOR EXTERIORS

Upper Body	Lower Body Sheet Metal, Wheels	Wheel Stripe (No Stripe on Series 2400)	Trim Combinations	Instrument Panel Center, Radio Cover Plate	Upper and Lower Instrument Panel, Steering Wheel, Steering Column, Steering Wheel Hub, Garnish Moldings, Dir. Signal Housing, Ash Tray Cover Panel, Door Locking Knobs, Heater Cover Panel
Onyx Black	Onyx Black	Argent	Gray & Black	India Ivory	Shadow Gray d
			Beige & Brown	Shoreline Beige	Navajo Tan
			Blue	India Ivory §	Glacier Blue
			Beige & Red	Bright Metal	Gypsy Red
			Red	Bright Metal	Gypsy Red
Sea-Mist Green	Sea-Mist Green	Black	Black & Ivory	India Ivory	Onyx Black
			Gray & Black	India Ivory	Shadow Gray d
			Green	Sea-Mist Green §	Neptune Green
			Beige & Brown	Shoreline Beige	Navajo Tan
			Green & Beige	Shoreline Beige	Neptune Green
Neptune Green	Neptune Green	Argent	Gray & Black	India Ivory	Shadow Gray d
			Green	Sea-Mist Green §	Neptune Green
			Beige & Brown	Shoreline Beige	Navajo Tan
			Green & Beige	Shoreline Beige	Neptune Green
			Beige	Bright Metal	Neptune Green
Cashmere Blue	Cashmere Blue	Argent	Gray & Black	India Ivory	Shadow Gray d
			Beige & Brown	Shoreline Beige	Navajo Tan
			Blue	India Ivory §	Glacier Blue
			Blue & Beige	India Ivory	Glacier Blue
Glacier Blue	Glacier Blue	Argent	Blue	India Ivory	Glacier Blue
			Gray & Black	India Ivory	Shadow Gray d
			Beige & Brown	Shoreline Beige	Navajo Tan
			Blue	India Ivory §	Glacier Blue
			Blue & Beige	India Ivory §	Glacier Blue
Shoreline Beige	Shoreline Beige	Black	Blue	India Ivory	Glacier Blue
			Gray & Black	India Ivory	Shadow Gray d
			Brown	Shoreline Beige	Navajo Tan
			Beige & Brown	Bright Metal	Navajo Tan
India Ivory	India Ivory	Black	Red	Bright Metal	Gypsy Red
			Blue & Beige	Bright Metal	Glacier Blue
			Gray & Black	India Ivory	Shadow Gray d
			Beige & Brown	Shoreline Beige	Navajo Tan
Shadow Gray	Shadow Gray	Argent	Blue	India Ivory §	Glacier Blue
			Beige & Brown	Shoreline Beige	Navajo Tan
			Gray & Black	India Ivory	Shadow Gray d
Gypsy Red	Gypsy Red	Argent	Blue	India Ivory §	Glacier Blue
			Beige & Red	Bright Metal	Gypsy Red
Regal Turquoise	Regal Turquoise		Beige & Brown	Shoreline Beige	Navajo Tan
Coral	Coral		Beige	Bright Metal	Regal Turquoise
Harvest Gold	Harvest Gold		Coral & Gray	Bright Metal	Shadow Gray
			Green	Bright Metal	Neptune Green

* - Available on special order on 1508. d - Black steering wheel and hub. § - Bright metal on 2400.

** - Series 2400 rear fender molding insert - Winter White.

● EXTERIOR-INTERIOR COLOR COMBINATIONS ONE COLOR EXTERIORS

SERIES 1500			SERIES 2100			SERIES 2400 **					2434 Top Color
1502 1503 1512	1529	1508	2102 2103 2154	2124	2109 2129	2402 2403	2434	2434	2409	2429	
●											
		●									
			●			●					
							●				
				●				●			
●			●			●					
	●		●			●					
		●		●							
●			●		●	●					
	●		●		●	●		●			
		●		●						●	
●											
		●									
			●			●					
				●							
●			●		●	●					
		●									
			●			●		●			
				●					●		
●			●		●	●					
		●									
			●			●					
●			●		●	●					
		●									
			●			●					
				●							
●			●		●	●					
		●									
			●			●					
				●					●		
			●			●					
		●									
			●			●					
				●							
		●									Belge
			●						●		
								●			
			●			●					
				●							
			●			●					
				●							
		●									White
			●			●					
				●				●			

10-29-54. Revised: 6-10-55. ● - Spring Colors added.
 CHEVROLET 1955 SPECIFICATIONS - PASSENGER

● EXTERIOR-INTERIOR COLOR COMBINATIONS
TWO-COLOR EXTERIORS

Upper Body Series 1500 & 2100 Except 2154 Roof, Deck, Pillars and Partial Quarters Series 2400 & 2154	Lower Body, Sheet Metal, Wheels,	Wheel Stripes (No Stripes on Series 2400)	Trim Combinations	Instrument Panel Center, Radio Cover Plate	Upper and Lower Instrument Panel, Steering Wheel, Steering Column, Steering Wheel Hub, Garnish Moldings, Dir. Signal Housing, Ash Tray Cover Panel, Door Locking Knob, Heater Cover Panel
Sea-Mist Green	Neptune Green	Argent	Gray & Black	India Ivory	Shadow Gray 4
			Green	Sea-Mist Green S	Neptune Green
			Green & Beige	Bright Metal	Neptune Green
India Ivory	Cashmere Blue	Black	Gray & Black	India Ivory	Shadow Gray 4
			Blue	India Ivory S	Glacier Blue
			Beige & Blue	India Ivory S	Glacier Blue
India Ivory	Shadow Gray	Argent	Gray & Black	India Ivory	Shadow Gray 4
			Blue	India Ivory S	Glacier Blue
India Ivory	Sea-Mist Green	Black	Green	Sea-Mist Green	Neptune Green
			Beige & Green	Shoreline Beige	Neptune Green
India Ivory	Onyx Black	Argent	Ivory & Black	India Ivory	Onyx Black
			Ivory & Gray	Bright Metal	Shadow Gray
India Ivory	Gypsy Red	Argent	Ivory & Black	India Ivory	Onyx Black
India Ivory	Regal Turquoise		Ivory & Turquoise	Bright Metal	Regal Turquoise
			Turquoise	Bright Metal	Regal Turquoise
Shoreline Beige	Neptune Green	Argent	Gray & Black	India Ivory	Shadow Gray 4
			Green	Sea-Mist Green S	Neptune Green
Shoreline Beige	Glacier Blue	Argent	Blue	India Ivory S	Glacier Blue
			Blue & Beige	India Ivory S	Glacier Blue
			Gray & Black	India Ivory	Shadow Gray 4
Shoreline Beige	Gypsy Red		Red	Bright Metal	Gypsy Red
			Beige & Red	Bright Metal	Gypsy Red
			Beige	Bright Metal	Gypsy Red
Onyx Black	India Ivory	Black	Ivory & Black	India Ivory	Onyx Black
			Ivory & Gray	Bright Metal	Shadow Gray
Shadow Gray	Coral		Coral & Gray	Bright Metal	Shadow Gray
Neptune Green	Sea-Mist Green		Green	Bright Metal	Neptune Green
			Beige	Bright Metal	Neptune Green
India Ivory	Harvest Gold	Black	Beige & Green	Shoreline Beige S	Neptune Green
			Green	Bright Metal	Neptune Green
India Ivory	Navajo Tan	Argent	Straw & Brown	Shoreline Beige	Navajo Tan
			Brown	Shoreline Beige	Navajo Tan
			Beige & Brown	Shoreline Beige S	Navajo Tan
			Green	Bright Metal	Neptune Green
			Beige	Bright Metal	Navajo Tan
India Ivory	Dusk Rose		Ivory & Gray	Bright Metal	Dusk Rose

4 - Black steering wheel hub.

S - Bright metal on 2400.

° - Series 2400 rear fender molding insert - Winter White.

● EXTERIOR-INTERIOR COLOR COMBINATIONS
TWO-COLOR INTERIORS

SERIES 1500			SERIES 2100			SERIES 2400 *					
1502 1503 1512	1508	1529	2102 2103 2154	2124	2109 2129	2402 2403	2454	2434		2429	2434 Top Color
●											
		●	●		●	●				●	
●			●	●	●	●	●	●		●	White
●			●	●		●			●	●	
			●	●							
			●	●							
				●							
				●		●	●	●			White
				●		●	●	●		●	White
●			●			●	●				
			●	●		●	●				
●				●	●				●	●	
							●				
								●			Beige
				●					●		
						●	●	●		●	Gray
								●			Green
				●					●		
						●	●	●		●	White
		●									
			●								
					●	●	●	●		●	White
						●	●	●			
								●			
						●	●	●		●	White

INTERIOR UPHOLSTERY AND COLOR COMBINATIONS

1500 SERIES

SEDANS

Models 1502-03-12

Color: Gray and black

Seats: Two-tone gray pattern cloth cushion and backrest with black elascofab backrest bolster. Gray pattern vinyl front seat back insert on 1502, 1503, black vinyl on 1512. Black vinyl lower cross bar. Black vinyl front seat end panels.

Sidewalls: Black vinyl upper and lower panel; gray pattern vinyl center panel; black embossed composition board quarter panels and rear partition in model 1512.

Horn button: Black paint, framed in bright metal, with bright metal shield.

Headlining and sunshade: Gray napped cloth. Gray vinyl sunshade binding and grip.

Floor covering: Front and rear - textured black rubber; luggage compartment - ribbed black rubber.

HANDYMAN

Model 1529

Color: Two-tone green, beige and brown

Seats: Beige or dark green linked cord pattern vinyl cushions, backrests and front seat back insert. Brown or light green vinyl backrest bolster and lower cross bar. Ribbed beige linoleum on rear seat back and bottom of cushion. Brown or light green vinyl on front seat end panels.

SEDANS

Models 2102-03-54

Color: Two-tone green, blue or brown

Seats: Light tone ribbed pattern cloth cushions and backrests. Dark tone gabardine ripple weave cloth backrest bolsters, cushion and backrest facings. Light tone gabardine ripple weave cloth front seat back insert; dark tone vinyl lower cross bar. Dark tone vinyl front seat end panels.

Sidewalls: Dark tone vinyl upper and lower panel, light tone ribbed vinyl center panel and scuff pad.

Arm rests: Light tone vinyl upper; light tone plastic base.

Headlining and sunshades: Light tone plain napped cloth. Light tone vinyl binding and grip on sunshade.

Floor covering: Front and rear - dark tone textured rubber; luggage compartment - ribbed black rubber.

CLUB COUPE

Model 2124

Color: Ivory and black; beige with green or blue.

Seats: Dark tone elascofab cushions and backrest bolsters with white saddle stitching. Light tone elascofab backrest, cushion and backrest facings. Light tone vinyl front seat back insert; dark tone vinyl lower cross bar. Dark tone vinyl front seat end panels.

Sidewalls: Dark tone vinyl upper panel with white

2400 SERIES

SEDANS

Model 2402-03

Colors: Two-tone green or blue, coral and gray, beige and brown, ivory and turquoise, ivory and gray.

Seats: Dark tone pattern cloth cushion and backrest. Light tone elascofab backrest bolster, cushion and backrest facings. Dark tone gabardine flat cloth front seat back insert; dark tone vinyl lower cross bar. Light tone vinyl upper and lower front seat end panels with bright metal molding.

10-29-54. Revised: 6-10-55. • - Model added.

26 - EQUIPMENT AND COLORS

Sidewalls: Brown or light green vinyl upper and lower panels; beige or dark green linked cord pattern vinyl center panel.

Horn button: Brown or light green paint, framed in bright metal, with bright metal shield.

Wheelhouse cover panels: Beige textured paint

Headlining and sunshade: Beige or light green vinyl
Floor covering and tail gate: Front and center - black textured rubber. Rear - ribbed beige linoleum on load space floor and tail gate.

SEDAN DELIVERY

Model 1508

Color: Beige and brown

Seats (bucket type) and side doors: Beige linked cord pattern vinyl cushion, backrests and center panel of sidewalls. Brown vinyl upper and lower panel of sidewalls, seat back and facing and door pillar.

Horn button: Brown paint framed in bright metal, with bright metal shield.

Headlining and sunshade: Beige vinyl

Load space sidewalls: Beige painted fiber board

Rear door inner panel: Beige painted steel

Floor covering: Driver's compartment - textured black rubber.

Load space: Black painted plywood

2100 SERIES

saddle stitching; light tone embossed vinyl center panel; dark tone vinyl scuff pad.

Arm rests: Dark tone vinyl upper; light tone plastic base.

Headlining and sunshades: Light tone vinyl

Floor covering: Front and rear - dark tone solid color carpet; luggage compartment - ribbed black rubber.

HANDYMAN AND TOWNSMAN

Models 2109-29

Colors: Two-tone green, beige and blue or brown.

Seats: Dark tone ribbed vinyl cushion and backrest. Light tone elascofab backrest bolster, cushion and backrest facings. Light tone vinyl front seat end panels. Dark tone vinyl front seat back insert and lower cross bar. Ribbed beige linoleum on rear seat back and bottom of cushion.

Sidewalls: Light tone vinyl upper and lower panel; dark tone ribbed vinyl center panel and scuff pad.

Arm rests: Dark tone vinyl upper; dark tone plastic base.

Headlining and sunshades: Light tone vinyl

Wheelhouse cover panels: Beige paint

Floor covering and tail gate: Front and center - Dark tone textured rubber. Rear - Beige ribbed linoleum on load space floor and tail gate.

INTERIOR UPHOLSTERY AND COLOR COMBINATIONS - Continued
2400 SERIES

SPORT COUPE
Model 2454

Colors: Beige with green, blue, red or turquoise; coral and gray and ivory and gray.

Seats: Beige or gray straw pattern cloth cushion and backrest. Dark tone or coral or ivory elascofab backrest bolster, cushion and backrest facings. Beige or gray vinyl front seat back insert; dark tone or gray vinyl lower cross bar and front seat end panels with bright metal molding.

Sidewalls: Dark tone or coral or ivory vinyl upper panel and scuff pad; beige or gray ribbed vinyl center panel.

Arm rests: Built-in front arm rests with beige or coral elascofab upper and beige or coral vinyl lower. Beige or gray elascofab upper and beige or gray vinyl lower rear arm rests.

Headlining and sunshades: Beige or coral or ivory vinyl.

Side window frames and exposed roof bows: Bright metal.

Floor covering: Front and rear - dark tone solid color carpet; luggage compartment - ribbed black rubber.

CONVERTIBLE
Model 2434

Color: Two-tone green or blue, beige and brown or red, coral and gray, ivory and turquoise, ivory and gray.

Seats: Dark tone elascofab cushion backrest and backrest upper facings. Light tone elascofab cushion facing, backrest bolster and backrest lower facings. Dark tone vinyl lower cross bar; light tone vinyl front seat back insert and front seat end panels with bright metal molding.

Sidewalls: Light tone vinyl upper panel and scuff pad; dark tone ribbed vinyl center panel.

Arm rests: Built-in front arm rests with dark tone elascofab upper and dark tone vinyl lower. Dark tone elascofab upper and dark tone vinyl lower rear arm rests.

Sunshades: Dark tone or coral or ivory vinyl.

Floor covering: Front and rear - dark tone solid color carpet; luggage compartment - ribbed black rubber.
 Top boot: Beige, ivory or dark tone elascofab.

BEAUVILLE
Model 2409

Color: Two-tone beige or blue and beige.

Seats: Beige straw pattern cushion and backrest. Light beige or blue backrest bolster, cushion and backrest facings. Ribbed beige linoleum on rear seat back and bottom of cushion; Beige vinyl front seat back insert and lower cross bar. Light beige or blue vinyl front seat end panels with bright metal molding.

Sidewalls: Light beige or blue vinyl upper panel and scuff pad; beige ribbed vinyl center panel.

Arm rests: Built-in front arm rests with beige elascofab upper and beige vinyl lower.

Headlining and sunshades: Beige vinyl.

Wheelhouse cover panels: Beige vinyl.

Floor covering and tail gate: Front and center - beige or blue textured rubber. Rear - Beige ribbed linoleum on load spacefloor and tail gate.

NOMAD
Model 2429x

Colors: Beige with green, blue, brown, red; ivory with turquoise, gray; coral and gray.

Seats: Dark tone, tufted elascofab seat cushion and backrest. Light tone pleated elascofab cushion and backrest bolster. Light tone elascofab cushion facings, backrest upper and outer facings, front seat end panels. Dark tone ribbed linoleum on rear seat back and bottom of cushion. Light tone elascofab front seat back insert, dark tone vinyl lower cross bar.

Sidewalls: Light tone vinyl forward and lower panels. Dark tone tufted elascofab upper panel. Light tone elascofab center panel. Stainless steel scuff pad.

Arm rests: Built-in front arm rests with ivory, beige or coral upper and lower.

Headlining and sunshades: Ivory, beige or coral perforated vinyl.

Floor covering and tail gate: Front and center--Dark tone solid color carpet. Dark tone linoleum on load space floor and tail gate.

BODY GLASS *

MODELS	1503 2103 2403	1502 2102 2124 2402	1512	2154 2454	2434	1529	2109, 2409	2129, 2429	1508
Windshield	Laminated safety plate, curved 1-piece								
Front door	Ventipanes	Laminated safety plate, curved 1-piece							
	Drop glass	Laminated safety plate, curved 1-piece							
Side rear door	Drop glass	LSP					LSP		
Rear quarter windows *	Movable section	Drop Glass		LSP				Front, LSP (2129 Only)	
		Sliding Glass						Front, LSP (2429 Only)	
		Pivoting Glass			LSP				
	Fixed Section	Safety Solid Plate		Safety Solid Plate			Front SSP Rear LSP	Laminated Safety Plate	Rear Laminated Safety Plate
Rear window (Backlite)	Safety solid plate, curved				Vinyl Plastic	Safety solid plate, curved			

* - On models 1529, 2129 and 2429 the front and rear sections are separated by a division post similar to the ventipane post used on the front doors.

LSP - Laminated safety plate. SSP - Safety solid plate.

10-29-54. Revised: 6-10-55. * - Data revised. x - New model added.

CHEVROLET 1955 SPECIFICATIONS - PASSENGER

CHASSIS FRAME

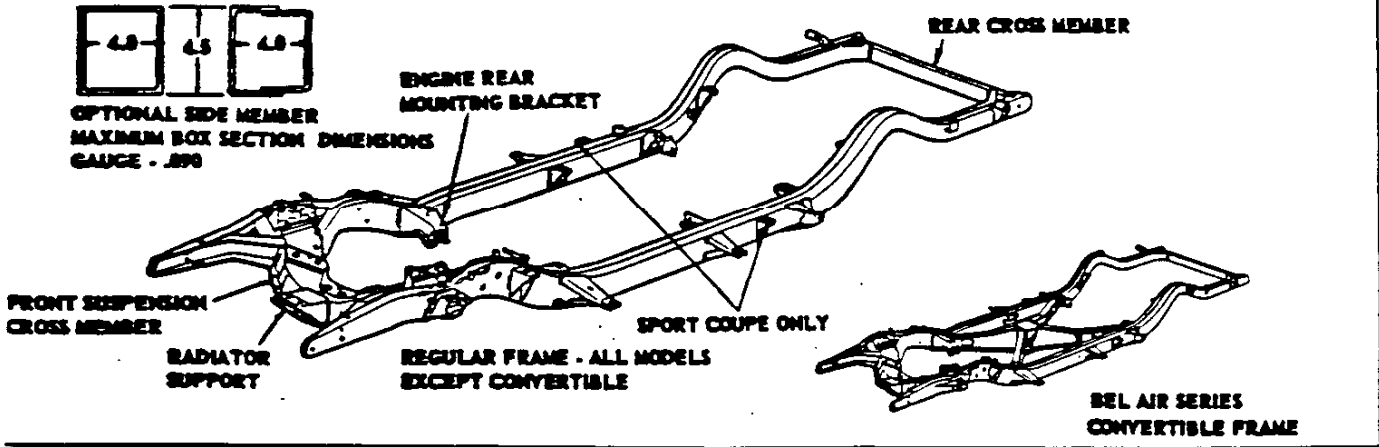

Material ----- Various
 Type ----- Box Girder
 Material ----- Hot rolled pickled steel
 Material yield point ----- 33,000 lbs/sq. in.
 Material elongation ----- 25% min in 2 inches
 Construction:
 Side members ----- Tubular stock rolled to rectangular section or two lapped channel sections welded together.
 Front suspension cross member ----- Flanged channel section with welded-on bottom plate.
 Engine rear supports ----- Two stamped brackets welded to side members.

Rear cross member ----- Single C-channel
 Body mounting points: Convertible ----- 20x
 Sport coupe ----- 16x
 All others ----- 14x
 Maximum overall length ----- 188.63
 Maximum width (over side members) ----- 42
 Side member section:
 Modulus (In.³) ----- 2.044
 Moment of inertia (In.⁴) ----- 4.600

CONVERTIBLE FRAME

Intermediate cross members are added through the use of an X-shaped I-beamed structure.

FRONT SUSPENSION

Material ----- Own
 Type ----- Independent, combining long and short wishbone arms with spherical joints and coil springs.
 Rated capacity ----- 2450 lb

WHEEL TRAVEL

Critical, loaded conditions (2/3 bumper compression) ----- 3.5 up and down
 Wheel to spring ratio ----- 1.9
 Wheel travel for steering -----
 ----- 36°-38° 30' from neutral to stop

SPRING BUMPERS

Material and number ----- Rubber; 1 each, L & RH
 Location ----- Lower control arms

SHOCK ABSORBERS

Make ----- Delco
 Type ----- Direct, double-acting hydraulic
 Mounting ----- Vertically from lower control arm through coil spring to front suspension cross member.
 Model number ----- 510F
 Valve code ----- 4J6/OX J L 1.5
 Piston diameter and travel ----- 1 x 4.69

SPRINGS* e

Usage	1508	1502-03-12-29; 2100; 2402-03-09-29 With 6 or 8 Cyl & 3-Speed Trans. 2154, 2454 with 8 Cyl & 3-Speed Trans.	1502-03-12-29; 2100; 2402-03-09-29-54. P. G. with 6 or 8 Cyl Engine. 2434 with 6 or 8 cyl and 3-Speed trans. 2454 with 6 cylinder and 3-Speed trans.	2434 P. G. With 6 or 8 Cyl.	1503, 2103 Taxicab With 6 or P. G.	1503, 2103 Taxicab With 6 Cyl & 3-Speed Trans.	
Make and type	Own, right hand helical coil						
Material	chrome alloy steel						
Gauge (Mean)	.623					.638	
Number of coils	Total 10; Active 8.67						
Outside diameter	4.848			4.883			
Pitch diameter	4.225						
Weight	Free	14.65	14.90	15.16	15.45	14.70	14.95
	Working	9.69 @ 1550 lbs	9.69 @ 1630 lbs	9.69 @ 1710 lbs	9.69 @ 1790 lbs	9.69 @ 1695 lbs	9.69 @ 1785 lbs
Weight under curb weight	9.92	10.28	10.31	10.33	10.17	10.52	
Capacity at ground	925 lbs	975 lbs	1000 lbs	1050 lbs	1000 lbs	1050 lbs	
Deflection	At spring	311 lb/inch					338 lb/inch
Rate	At wheel	109 lb/inch					109 lb/inch

Continued

- Spring data for models equipped with Air Conditioning not available.

0-29-54. Revised: 6-10-55, e - Data revised. x - Data corrected. * - Data added.

1 - FRAME FRONT SUSPENSION

CHEVROLET 1955 SPECIFICATIONS - PASSENGER

FRONT SUSPENSION - Continued

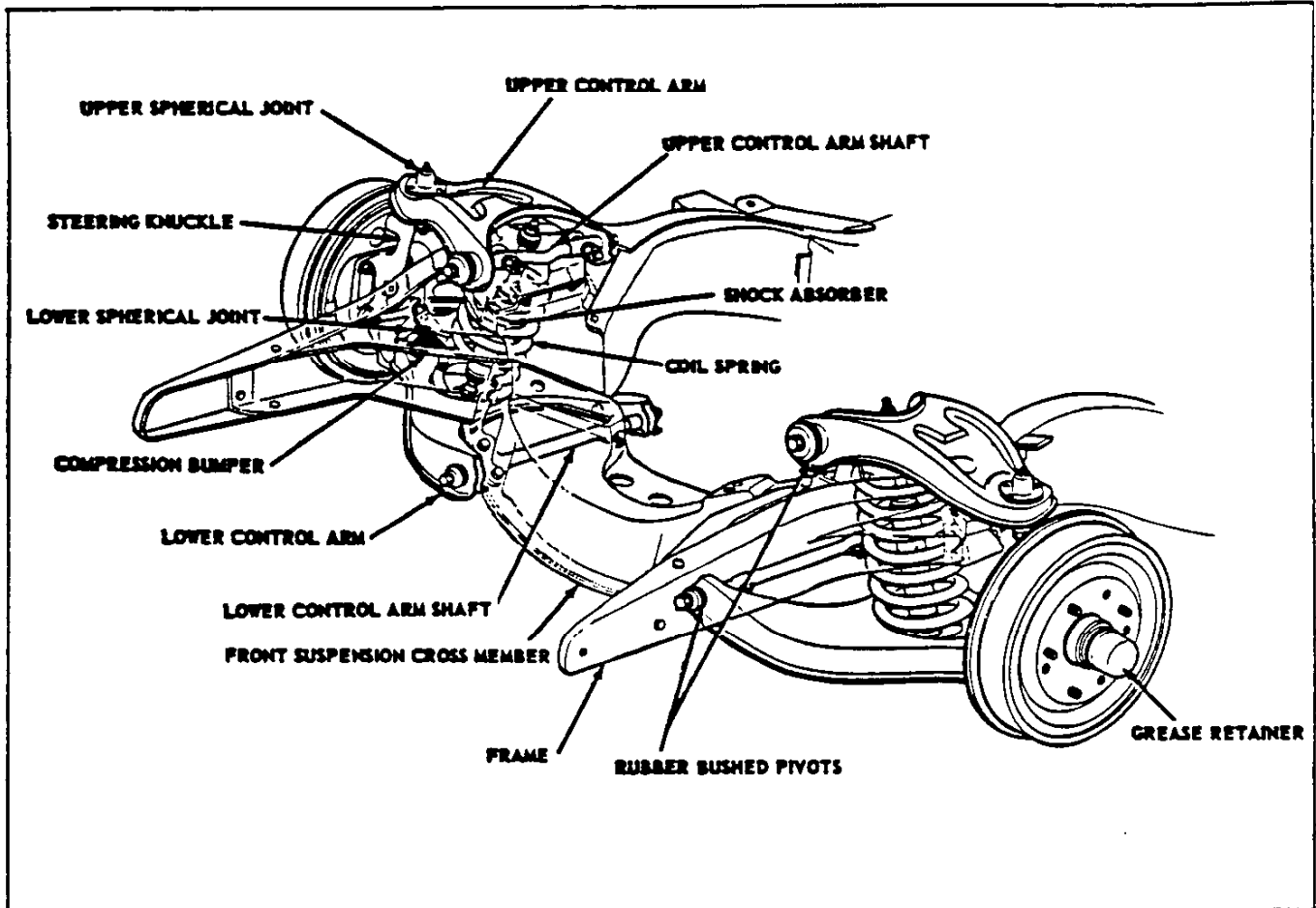

STEERING KNUCKLE

Type-----Reverse Elliott in combination with spherical joints eliminating kingpin and steering knuckle support.
 Spindle diameters:
 At inner bearing----- 1.2490-1.2495
 At outer bearing----- .7490-.7495

SPHERICAL JOINTS

Type-----Ball stud and socket in assembly; self-adjusting for wear.
 Number-----1 each, upper & lower; LH & RH
 Ball stud:
 Material-----H. R. steel, hardened and ground.
 Attachment----- Bolted to steering knuckle upper or lower arm.
 Ball stud seating material----- Asbestos composition (within socket).
 Ball stud seal----- Water tight steel-reinforced rubber unit with nylon bushing.
 Socket:
 Type and material----- Two inverted cup-shaped steel stampings bonded by grease-tight weld. Upper socket assembly is spring-loaded to compensate for wear and vertical movement.
 Attachment----- Rivetted to upper or lower control arms.
 Lubrication----- Through high pressure fitting at top of each socket.

BUSHINGS

Type & number----- Friction; 4 (2 each pivot shaft, Left hand and Right hand)
 Material----- Steel encased rubber
 Size:
 Upper control arm pivot shaft----- .670-.675ID X 1.76 approximately
 Lower control arm pivot shaft----- .737-.742ID X 2.08 approximately
 Mounting-----Through control arms and onto pivot shaft ends.
 Attachment-----By bolts in shaft ends holding bushing retainers.

BEARINGS

Wheel bearing lubricant----- High melting-point grease
 Anti-friction bearings-----See pages 171, 172

FRONT WHEEL ALIGNMENT (Service Data)

Camber, caster adjustment-----By shims between upper control arm cross shaft & frame.
 Camber----- 0° to 1°
 Caster----- Minus 1/2° to plus 1/2°
 Steering axis inclination----- 3-1/2°
 Toe-in----- 1/8 to 3/16
 Toe-out on turns:
 Outside wheel----- 18° 10"
 Inside wheel----- 20°

10-29-54

REAR SUSPENSION

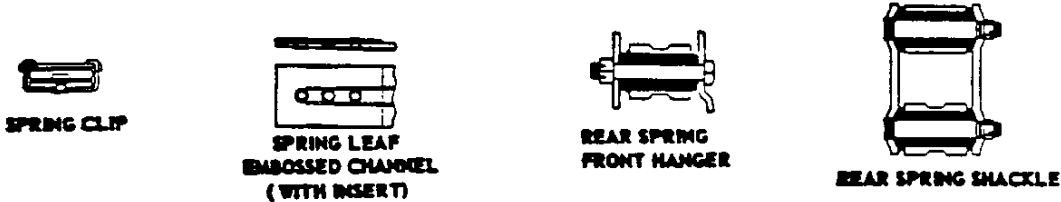
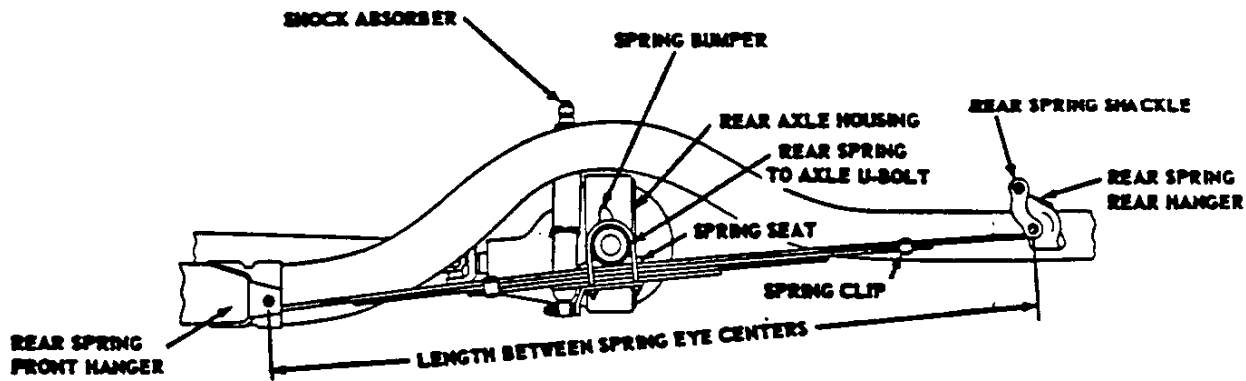

SPRINGS

Make and type----- Own, semi-elliptic
 Material----- Chrome carbon steel
 Length and width----- 58 x 2
 Spring leaf type----- Full-length embossed channel with tapered ends.
 Spring clips----- Clinch type; two on four leaf spring; three all others.
 Spring covers----- None
 Spring leaf inserts----- Wax-impregnated cotton webbing strips attached with brass eyelets.

TEM		● 1502-03-12; 2102-03-24-54; 2402-03-34-54	● 1508(RPO 1502, 03-12;2102-03-24- 54;2402-03-34-54)	● 1529;2109-29;2409- 29(RPO on 1502-03- 08-12;2102-03-24- 54;2402-03-34-54)	RPO 1500, 2100 2400
Number of leaves		4	5	5	6
Thickness of leaves	#1 & 2				.347
	#3				
	#4	.291	.313		
	#5				.291
#6				.291	
Total thickness		1.298	1.611	1.679	2.026
Leaf ends drilled for attaching inserts		2 & 3	2, 3 & 4		
Average rate of deflection (lb/in.)		112	126	144	177
Camber height at design load		.125 negative			
Capacity at spring pad (lb)		820	900	1000	1100
Capacity at ground (lb)		1050	1100	1200	1300

SPRING MOUNTING

Type----- Parallel, 46 between centers.
 Front eye bolt diameter----- .493-.500
 Front eye bolt bushing, type & size----- Rubber bushed, .505 min ID X 2.552-2.572 long
 Shackle mounting----- Outrigger type
 Shackle type----- Rubber bushed
 Shackle pin OD----- .623-.627
 Shackle bushing, size & number----- 1.110-1.120 OD X 1.474-1.494 long; two per shackle pin
 Spring to axle attachment----- 2 U-bolts (.50 dia) to spring seat on rear axle housing

SHOCK ABSORBER

Make and type----- Delco, hydraulic; direct double-acting
 Model number----- 560Y
 Valve code----- 4.25G6/OXG/L1.5
 Piston diameter and travel----- 1, 8.94
 10-29-54. Revised: 6-10-55 ● New Model Added

REAR AXLE

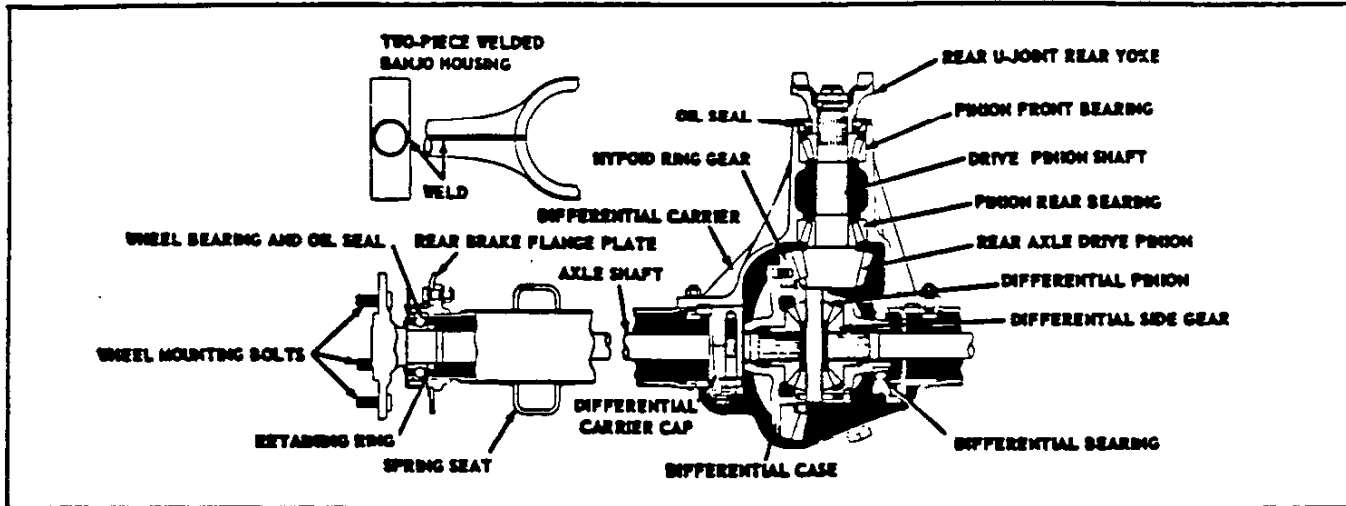

GENERAL DATA

Make Own
 Type Semi-floating
 Rating 3000 lb
 Hotchkiss drive:
 Drive taken through Springs
 Torque taken through Springs
 Housing type
 --- Pressed steel banjo, 2-piece welded construction with axle housing rear cover welded in place
 Lubricant capacity 4 Pints
 Lubricant recommended SAE 90 passenger car hypoid lubricant or "Multi-Purpose" lubricant
 Bearings Anti-friction, see pages 148-151

GEARS

Final drive:

Transmission	3-Speed Conventional	3-Speed Overdrive	Powerglide
Type	Spiral hypoid		
Ratio	3.70:1	4.11:1	3.55:1
Teeth ring gear & pinion	37 & 10	37 & 9	39 & 11
Gear backlash	.005-.008		

Pinion gear:

Mounting Overhung
 Thrust taken by Pinion rear bearing
 Adjustment
 --- By shims with .027 average thickness

* - Axle ratio x transmission ratio

⊕ - Gear reduction x maximum net engine torque x efficiency factor (.90 indirect drive, .85 all others).

Item	Regular	Overdrive	
Axle ratio	3.70:1	4.11:1	
Overdrive Ratio		Out In	
Total gear reduction *	1st	10.88	12.08
	2nd	6.22	6.90
	Direct	3.70	4.11
	Reverse	10.88	12.08
⊕ Maximum axle shaft torque in ft lb (Low gear)	1803	2002	

Powerglide:

Total torque multiplication (final drive gears, transmission, torque converter and planetary gears).
 Drive 3.55:1 to 7.46:1
 Low 6.46:1 to 13.57:1
 Reverse 6.46:1 to 13.57:1

AXLE SHAFT

Type and material Forged and hardened steel
 With wheel drive flange forged integral with shaft.
 Minimum diameter 1.06
 Oil seal Steel-encased spring loaded synthetic rubber (part of rear wheel bearing assembly)
 Hub attachment
 --- Bolted to integrally forged wheel drive flange

DIFFERENTIAL

Type Two pinion with cast arma-steel housing
 Bearing cap bolt torque 70-75 ft lb

BRAKES

POWER BRAKES (RPO 412)

Type Vacuum assisted hydraulic unit with integral master cylinder
 Components
 Hydraulic power unit mounted on dash under hood.
 Location Hydraulic power unit mounted on dash under hood. Vacuum reserve tank mounted on left front fender splash pan.
 Braking assistance %
 By vacuum cylinder 40%
 By foot pedal 60%

% - These figures are approximate depending on the severity of stop.

Continued

Braking ratio:

Pedal 1.55:1
 Hydraulic 10.6:1
 Overall 16.4:1
 Pedal, load to actuate power brakes 10 lb
 Stop light switch:

Type Hydraulic
 Mounting On hydraulic power unit

Fluid:

Type Same as regular brakes
 Capacity (Complete brake system) 0.80 Pints

BRAKES - Continued

SERVICE BRAKES

Make----- Own
 Type----- Servo, four wheel, hydraulic
 Brake drum:
 Type----- Composite
 (cast alloy iron rim & pressed steel web)
 Diameter, front and rear----- 11
 Total effective area----- 259 sq. in.
 Distribution of braking effort (theoretical):
 On front wheels----- 56%
 On rear wheels----- 44%
 Brake lining:
 Material----- Full molded asbestos composition
 Width, front brakes----- 2.00
 Width, rear brakes----- 1.75
 Thickness (Before grinding)----- .202-.222
 Length per wheel----- 21
 Length, primary shoe----- 9.312
 Length, secondary shoe----- 11.687
 Method of attachment to shoe----- Bonded
 Clearance----- Adjust to a
 light drag and back-up seven notches.
 Total effective area----- 158 sq. in.
 Main Cylinder:
 Mounting----- Under hood on dash panel
 Diameter----- 1
 Piston travel----- 1
 Wheel cylinders:
 Mounting----- Front, on wheel spindles;
 rear on backing plate.
 Front, inside diameter----- 1.125
 Rear, inside diameter----- 1
 Piston travel----- .221
 Braking ratio:
 Pedal----- 6.42:1
 Hydraulic----- 4.53:1
 Total overall----- 29.1:1

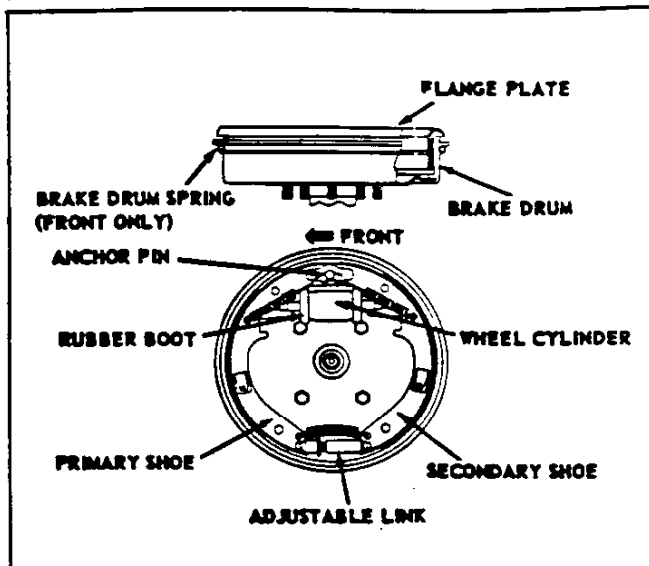

Foot pedal:
 Type----- Pendant
 Travel----- 6.38
 Mounting----- On brace under dash
 Pad cover material----- Rubber
 Brake system fluid capacity----- .70 pint approx.
 Brake fluid recommended----- Deico Super 11

PARKING BRAKE

Make and type----- Own, mechanical pull rods
 and cables operate the two rear service brakes.
 Total effective lining area----- 74 sq. in.
 Control----- T-handle on ratchet-rod (pull to apply,
 turn 60° counter clockwise to release, mounted be-
 low instrument panel to left of steering column.

DRIVE SYSTEM

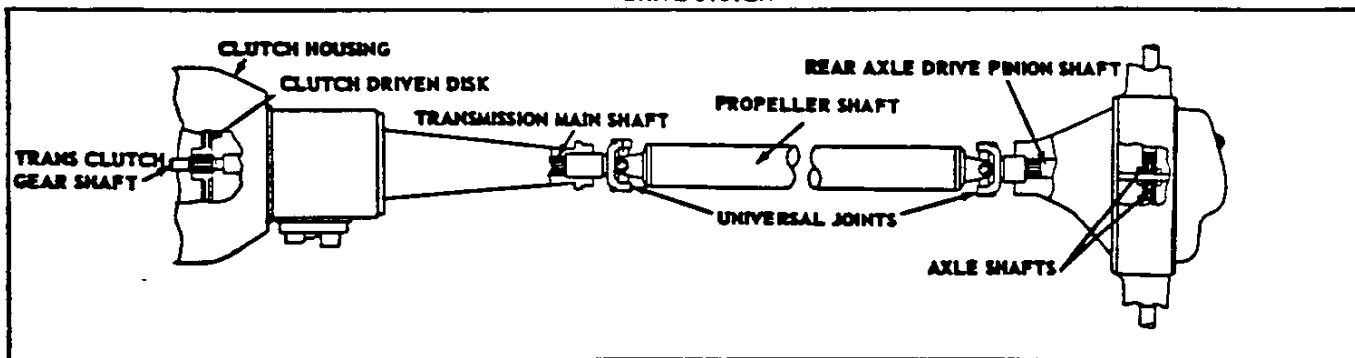

SPLINES

FUNCTION OF SPLINES:

Clutch disc hub to transmission clutch gear shaft-----	10 straight side
Transmission mainshaft to U-joint front yoke-----	16 involute
Propeller shaft pinion flange to rear axle pinion shaft-----	17 involute
Differential side gears to rear axle shafts-----	17 involute

NUMBER AND TYPE OF SPLINES

UNIVERSAL JOINT

PROPELLER SHAFT
 Make and type----- Own, tubular
 Tube O.D.----- 2.995-3.005
 Tube wall thickness----- .062-.068
 Oil seal----- Steel-reinforced, spring loaded leather
 Front and rear ends type----- Welded yoke
 10-29-54

Make----- Own
 Type----- 2, yoke and spider (trunnion)
 Trunnion material----- Drop-forged steel, hardened
 Trunnion pin diameter----- .5955-.5960
 Bearing, front & rear-- Anti-friction, see pages 171, 172
 Lubrication----- Bearings packed for life

ENGINE - GENERAL

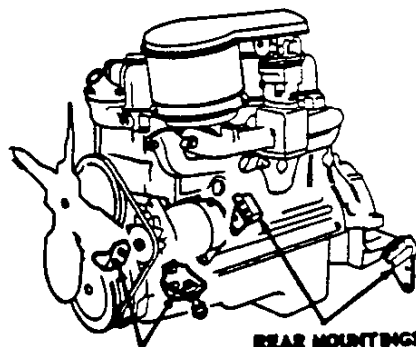
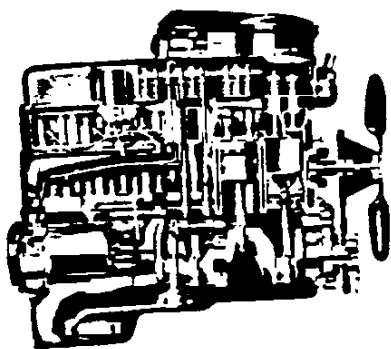

FRONT MOUNTINGS

REAR MOUNTINGS

BASIC ENGINE DATA

Engine	Regular	Powerglide
Piston displacement (cu. in.)	235.5	
Type	Valve-in-head	
Number of cylinder	6	
Bore and stroke (Nominal)	3.56 x 3.94	
Compression Ratio	7.5:1	
Taxable (SAE) horsepower	30.4	
Idling speed (RPM)	475 in neutral	425 in drive
Compression pressure at cranking speed, engine hot (PSI)	130 (or better)	
Dry Weights (Pounds)	Engine	e607@
	Engine and transmission	e672*; e699§ e777
Lubrication	Full pressure	
Power plant mounting	4-Point rubber-cushioned, strut-type front mounts & shear-type rear mounts	

ADVERTISED MAXIMUM ENGINE PERFORMANCE

Engine	Blue Flame 123	Blue Flame 136
Brake horsepower	Gross	123 @ 3800 RPM
	Net	109 @ 3600 RPM
Torque (ft lb)	Gross	207 @ 2000 RPM
	Net	195 @ 2000 RPM

ENGINE SPEED AND PISTON TRAVEL

Engine and transmission	Regular with 3-speed	Regular with overdrive		Powerglide
		O.D. locked out	O.D. locked in	
Rear axle ratio	3.70:1	4.11:1		3.55:1
Tire size	6.70-15-4 ply			
Crankshaft revolutions per mile	2790.0	3099.0	2169.0	2677.0
Crankshaft RPM at one MPH	Low and reverse	136.6	151.7	106.1§
	Second	78.1	86.7	60.6
	Direct †	46.4	51.6	36.1
Piston travel (ft/mile)	1831.0	2034.0	1423.0	1757.0

ADVERTISED CAR PERFORMANCE

The following information is based on model 2103, 4-Door Sedan (with and without Powerglide) at performance weight (Curb weight plus 600 lbs to represent four passengers):

Model	2103	2103 PG
Performance weight (pounds)	3910●	4005●
Pounds/gross horsepower	31.79●	29.45●
Pounds/cu. in. piston displacement	16.60●	17.01●
Gross horsepower/cu. in. displacement	.522●	.577●
Power displacement (cu. ft/mile)‡	190.12●	182.42‡●
Displacement factor (cu ft/ton mile)‡	97.25●	91.10‡●

● - Including clutch for Conventional or Overdrive transmission.

* - Including clutch with 3-Speed transmission. † - Including clutch with Overdrive transmission.

§ - Applicable to low gear only. Overdrive does not function in reverse.

‡ - Crankshaft rev/mile x piston displacement † - Also known as N/V factor.

1728 x 2

- Power displacement divided by the performance weight in tons.

§ - These data are computed assuming zero slippage in the torque converter.

10-29-54. Revised: 6-10-55, ● - Data revised.

CHEVROLET 1955 SPECIFICATIONS - PASSENGER

ENGINE, SIX CYLINDER - 33

ENGINE PERFORMANCE

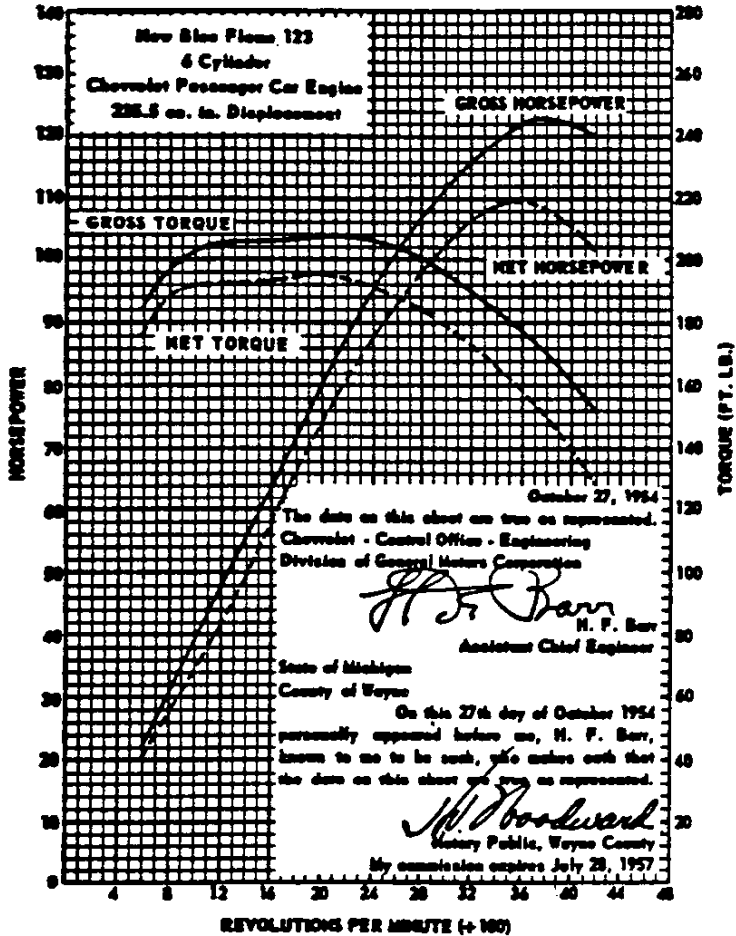

The engine performance curves shown on this sheet are taken from Chevrolet engine test report 16926-80. They represent the full throttle performance of a New Blue Flame 123 six cylinder passenger car engine (235.5 cu. in. displacement) as obtained from dynamometer test data which were corrected to the standard barometric pressure 29.92"Hg. and the standard temperature of 60°F.

ular dynamometer test with the dynamometer exhaust system, no fan, generator not charging, and optimum spark advance.

NET POWER and TORQUE were obtained from a dynamometer test simulating actual operating conditions when the engine is in its vehicle. It includes the use of the regular muffler and pipes, the fan in operation and automatic spark advance. The generator is not charging.

GROSS POWER and TORQUE were obtained in a regular dynamometer test with the dynamometer exhaust system, no fan, generator not charging, and optimum spark advance.

0-29-54
4 - ENGINE, SIX CYLINDER

CHEVROLET 1955 SPECIFICATIONS - PASSENGER

ENGINE PERFORMANCE

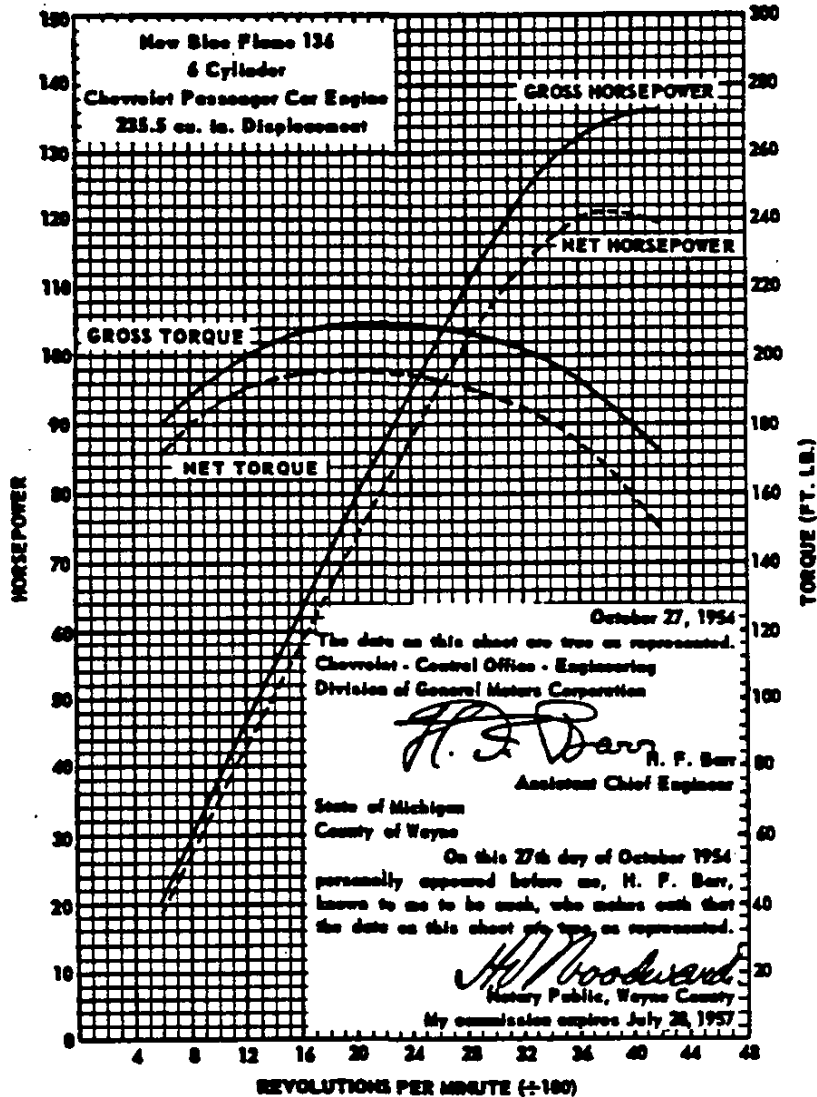

The engine performance curves shown on this sheet are taken from Chevrolet engine test report 16926-80. They represent the full throttle performance of a New Blue Flame 136 six cylinder passenger car engine (235.5 cu.in. displacement) as obtained from dynamometer test data which were corrected to the standard barometric pressure 29.92"Hg. and the standard temperature of 60°F.

ular dynamometer test with the dynamometer exhaust system, no fan, generator not charging, and optimum spark advance.

NET POWER and TORQUE were obtained from a dynamometer test simulating actual operating conditions when the engine is in its vehicle. It includes the use of the regular muffler and pipes, the fan in operation and automatic spark advance. The generator is not charging.

GROSS POWER and TORQUE were obtained in a reg-
10-29-54
CHEVROLET 1955 SPECIFICATIONS - PASSENGER

ENGINE, SIX CYLINDER - 35

CYLINDER CASE AND HEAD

Material ----- Cast alloy iron Offset ----- None
 Cylinder head bolt torque ----- 90-95 ft lb Bore diameter ----- 3.5620-3.5640

CRANKSHAFT AND BEARINGS

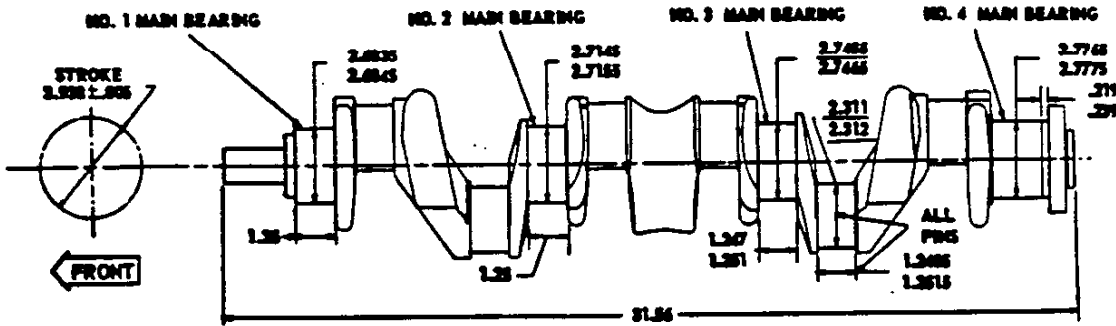

CRANKSHAFT

Material ----- Drop-forged steel
 Weight (Crankshaft & pilot bearing assembly) ----- 80 lb
 End play ----- .0035-.0095
 Counter weights ----- 7
 Stroke ----- 3.938 ± .005

MAIN BEARING

Type ----- Precision, removable
 Removable ----- From below
 Necessary to align ream ----- No
 Clearance ----- .0004-.0025 fit with solid shim
 End thrust against ----- #3 bearing
 Bearing cap bolt torque -----
 ----- 100-110 ft lb with oiled threads

Brg	Theo L.D.*	Eff Length ‡	Proj Area §
1	2.6855	1.063e	2.855 sq. in.
2	2.7165	.907	2.464 sq. in.
3	2.7475	.968	2.658 sq. in.
4	2.7785	1.189e	3.304 sq. in.

**HARMONIC BALANCER
 (Vibration Damper)**

Type ----- Oscillating (Rubber-floated)
 Crankshaft pulley:
 Pitch diameter ----- 6.64

* - Journal diameter plus clearance
 ‡ - Overall length minus chamfers
 § - Based on theoretical L.D. and effective length

CAMSHAFT AND BEARINGS

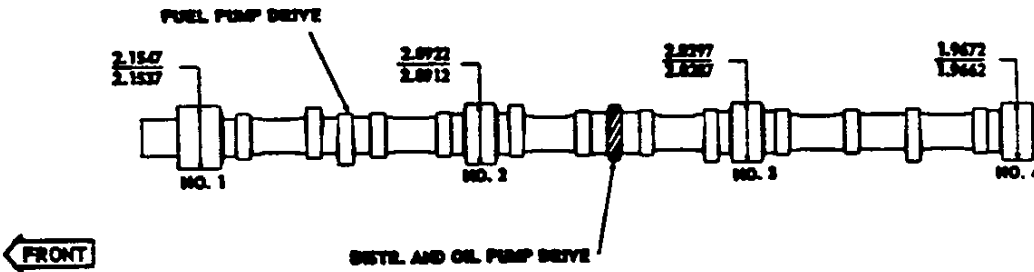

CAMSHAFT

Material ----- Cast alloy iron
 End play ----- .003-.007
 High lift type ----- Powerglide only
 Thrust taken by ----- Thrust plate between
 driven timing gear and camshaft #1 journal front face.
 Lash: (Regular)
 Inlet (Opening & closing) ----- .0111, 28° long
 Exhaust (Opening & closing) ----- .0140, 36° long
 Lash: (Powerglide) Inlet and exhaust
 Opening ----- .00549, 15° long
 Closing ----- .00705, 29° long

Driven gear (On camshaft) material -----
 ----- Bakelite and fabric composition with steel hub
 Drive gear (On crankshaft) material ----- Steel

BEARING

Material ----- Steel backed babbitt
 Clearance on diameter ----- .0010-.0030

Brg	Ream dia	Overall length	Proj Area
1	2.1562	1.12	2.415 sq. in.
2	2.0937	.94	1.968 sq. in.
3	2.0312	.94	1.909 sq. in.
4	1.9687	.94	1.846 sq. in.

⊖ - Based on ream diameter and overall length as shown above.

DRIVE

Make and type ----- Own, helical gear
 0-29-54. Revised: 6-10-55, e - Data revised.
 6 - ENGINE, SIX CYLINDER

PISTON-PIN-RINGS

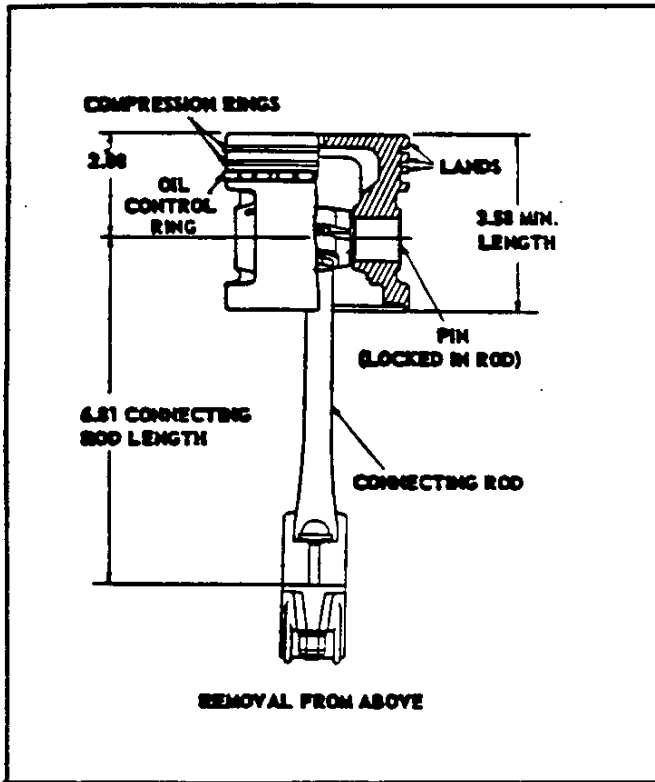

PISTON

Make-----	Own
Features-----	Flathead, tin plated, oval with controlled thermo expansion
Material-----	Cast alloy aluminum with steel struts
Skirt clearance in cylinder bore-----	.0005-.0011
Land clearance in cylinder bore-----	.028-.036
Compression and oil ring groove depth-----	.199-.205
Oil ring holes, number and size-----	8, .156 drill
Head thickness at center-----	.235-.245
Piston pin bushings-----	None
Weight of piston-----	1.18
Weight of piston, rings, pin and connecting rod upper end x 6 (Units/engine)-----	12.50

PISTON PIN

Type-----	Locked in rod
Material-----	Chromium steel (File hard case)
Diameter-----	.8660-.8665
Length-----	3.168-3.198x

CONNECTING RODS

Material-----	Drop-forged steel
Rod width at piston pin-----	1.126-1.129
Rod width at crank pin-----	1.2415-1.2435
Crankpin bearing:	
Type-----	Precision interchangeable insert
Material-----	Steel backed, thin wall babbitt
I. D. (Theoretical)-----	2.3133 A
Effective length-----	1.008 O
Clearance on diameter-----	.0007-.0028
A - Crankpin diameter plus clearance	O - Overall length minus chamfers

Taper limit in full length-----	.0002
Weight-----	.320
Clearance in piston-----	.00015-.00025
Offset in piston-----	5/64
Direction offset-----	Major thrust side

COMPRESSION RINGS

Material-----	Cast alloy iron, surface treated with a wear resistant coating
Type-----	Thick-wall, inside bevel or counter bored
Number per piston-----	2
Width-----	.0930-.0935
Wall thickness-----	.168-.178
Gap clearance-----	.007-.017
Ring clearance in groove-----	.0020-.0035
Weight (Each)-----	.04216

OIL CONTROL RING

Material and type-----	Steel, multi-piece, 2 rails and spacer
Upper and lower rails-----	Flat spring or scale less tempered steel; full chrome plate O.D.
Spacer (Between rails)-----	Flat spring steel
Gap clearance (On rails)-----	.015-.055
Ring clearance in groove-----	.000-.008
Width-----	.181-.188
Maximum wall thickness (Rails)-----	.153
Weight:	
Spacer-----	.020
Segment (Each)-----	.022

† - Based on theoretical I. D. and effective length
 10-29-54. Revised: 6-10-55, e - Data revised, x - Data corrected.
CHEVROLET 1955 SPECIFICATIONS - PASSENGER

VALVE TRAIN

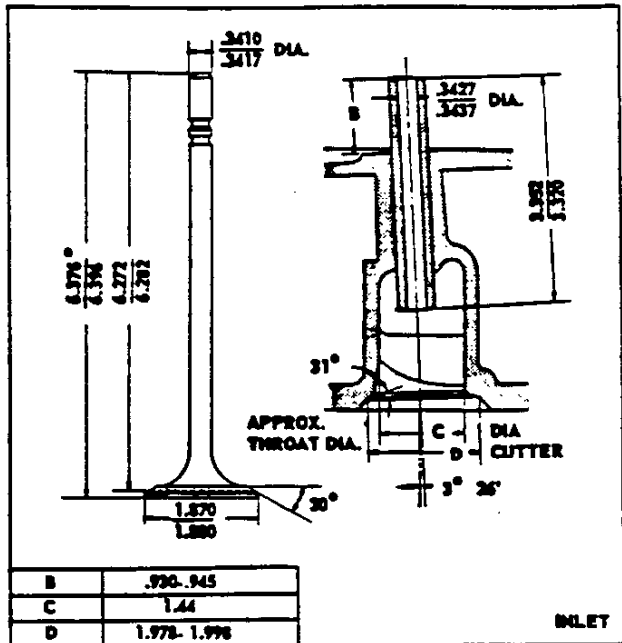
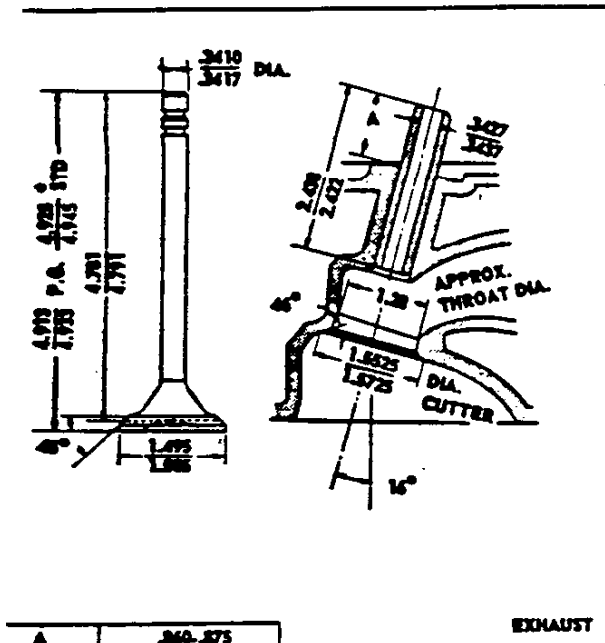

B	.926-.945
C	1.44
D	1.972-1.998

Inside diameter----- .7925-.7935
 Length----- .9354

VALVES

or conventional transmission engine:
 Make----- Own
 Material: Exhaust valve----- Silicon-Nickel-chrome
 Inlet valve----- Silicon-chrome or Nickel-chrome
 Stem and style----- Grooved for keys and oil seal
 Lift: Exhaust valve----- .3118
 Inlet valve----- .2941
 Face angle: Exhaust valve----- 45°
 Inlet valve----- 30°
 Distance between valve centers (measured along centerline of engine)----- 1.547
 Valve lash (engine normalized) *
 Exhaust----- .013
 Inlet----- .006
 - To normalize engine, run it at fast idle (approximately 600 RPM) until a constant oil temperature is attained for a period of five minutes.
 or Powerglide transmission engine:
 Material: Exhaust valve----- Moly-nickel-chrome
 Inlet valve----- Silicon-chrome or Nickel-chrome
 Lift: Inlet and exhaust----- .4004
 Valve lash (hydraulic lifter):
 At time of assembly----- Basic adjustment
 During operation----- Self-adjusting
 All other data----- Same as for conventional transmission engine.

VALVE ROCKER ARMS

Material----- Cast malleable iron
 Ratio (valve lift to cam lift)----- 1.477:1
 Torque of valve rocker shaft support bolts and nuts----- 25-30 ft lb
 Finishing: Type----- Machined in rocker arm

VALVE SPRINGS

Length and Pressure	Item	Regular		Powerglide		
		Inlet	Exhaust	Inner	Outer	
Valve Closed	Valve Closed	Inlet	1.821 @ 62-68 lb	1.858 @ 74-82 lb		
		Exhaust		Inner	1.788 @ 27-31 lb	
	Valve Open	Inlet	1.505 @ 155-165 lb	Outer	1.858 @ 66-72 lb	
		Exhaust		1.462 @ 196-208 lb		
Free Length	Free Length	Inlet	2.16	Inner	1.392 @ 55-61 lb	
		Exhaust		Outer	1.462 @ 150-160 lb	
			2.234			
					Inner	2.375
				Outer	2.280	

VALVE SEATS

Material----- Cast alloy iron (cylinder head)
 Inserts----- None
 Angle: Exhaust seat (in head)----- 46°
 Inlet seat (in head)----- 31°
 Width in head:
 Exhaust seat----- .062-.093
 Inlet seat----- .035-.060

VALVE STEM GUIDES

Type----- Removable
 Clearance with stem: Exhaust & inlet----- .001-.0027

TAPPETS

(For conventional transmission engine only)
 Type----- Cylindrical
 Material----- Cast alloy iron
 Outside diameter----- .989-.990
 Lift: Exhaust----- .2111
 Inlet----- .1991
 Clearance----- Selective fit

HYDRAULIC VALVE LIFTERS

(For Powerglide transmission engine only)
 Make----- GM Diesel
 Material: Lifter body----- Cast iron
 Lifter plunger and push rod seat----- Steel
 Lift: Exhaust and inlet----- .2711
 Oil flow----- Oil enters the valve lifter oil gallery through a drilled passage from the camshaft rear and front bearings, where it flows to the hydraulic lifters. Oil enters the valve lifters through holes in the side of the lifter body and plunger. Oil enters the ram chamber around the steel ball.

10-29-54. Revised 6-10-55, e - Data revised.
 1 - ENGINE, SIX CYLINDER

ENGINE LUBRICATION SYSTEM

METHOD OF LUBRICATION

Type----- Full pressure
 Main bearings----- Direct pressure through drilled passages in the cylinder case to the bearings. Oil from main bearings flows through drilled passages in the crankshaft to the connecting rod bearings.
 Cylinder walls and piston pins----- Sprayed by oil metered through a hole in the connecting rod journal boss.
 Camshaft bearings----- Direct pressure through passages from main bearings.
 Timing gears----- Sprayed by a nozzle fed from the camshaft front bearings.
 Valve mechanism----- Oil flows under pressure from rear camshaft bearing through metering hole in pipe fitting; then is piped to rocker shafts and arms. Valve stems, springs, and push rod ends are gravity fed from rocker arms.

OIL PAN

Type----- Rear sump with welded-in baffle
 Capacity----- 5-1/2 qt, dry; 5qt, for refill
 Drain----- Drain plug in rear of pan
 Torque, corner bolts----- 12-1/2 to 15 ft lb
 Torque, flange screws----- 6 to 7-1/2 ft lb

FUEL TANK

Type----- 2 stamped pans, seam-welded together
 Capacity:
 Station Wagon & Sedan Delivery----- 17 gallons
 All others----- 16 gallons
 Mounting----- Supported by two straps attached to under body between rear axle and rear cross member of frame; all models.
 Filler:
 Location & access----- Through door in left rear fender; all models.
 Fuel gauge (tank unit):
 Make & type----- AC, electric; riser pipe & filter integral with unit.
 Filter----- 40 mesh metal filter cloth tube mounted on end of riser pipe.

FUEL PUMP

Make & model----- AC, model EM
 Type----- Mechanical (diaphragm) "high reserve"
 Drive----- From camshaft
 Arm movement----- 1/4 at camshaft
 Air dome----- Yes (inlet & outlet)
 Pressure at carburetor----- 3.5 to 4.5 PSI
 Filter----- None (See Fuel Tank)

CARBURETOR

Make----- Rochester Products
 Models:
 For conventional transmission engine----- 7007181
 10-29-54. Revised: 6-10-55, e-Data revised.
CHEVROLET 1955 SPECIFICATIONS - PASSENGER

OIL PUMP

Type and drive----- Gear, from camshaft
 Capacity (gallons per minute, hot oil)-----
 4.01-4.22 @ 1170-1200 Engine RPMs
 Normal oil pressure----- 30 PSI @ 1170-1200 Engine RPMs
 Width of gears-----
 Intake----- "Floto-type" with 16 mesh galvanized wire screen.

MISCELLANEOUS

Oil filler----- Through valve rocker cover
 Crankcase oil level gauge type----- Rod
 Oil pressure----- "Tell-tale" light in instrument cluster
 Crankcase ventilation:
 Inlet----- Through breather-type oil filler cap on valve rocker cover.
 Outlet----- Through road draft pipe at right side of engine.
 Oil filter (RPO 237): Make & type----- AC, partial flow
 Capacity (dry)----- 1 quart
 Flow----- Approximately 39.5 gal/hr
 Oil cooler----- None

LUBRICANT RECOMMENDED

Temperature: Grade
 Not lower than 32°F----- SAE 20W or SAE 20
 As low as 10°F----- SAE 20W
 As low as minus 10°F----- SAE 10W
 Below minus 10°F----- SAE 5W

FUEL AND EXHAUST SYSTEMS

For Powerglide transmission engine----- 7007180
 Type----- Single adjustment, balanced, downdraft
 SAE Flange Size----- 1.50
 Size (Main venturi throat ID)----- 1.34
 Choke----- Automatic
 Basic idle adjustment, number of turns----- 1-1/2
 Float level, bottom of float to cover----- 1.28

INTAKE MANIFOLD

Manifold heat control----- Automatic (thermostatic)

OCTANE SELECTOR

Type----- Manual, 20° Range, on distributor assy.

AIR CLEANER

Regular or RPO	Regular	216C
Flame arrester	Yes	
Silencer	Yes	
Filter element	Cu or Al ribbon	Cactus fiber
Type	Oil-wetted	Oil bath
Dirt capacity		1 pound
Used with gov	No	Yes

EXHAUST SYSTEM

Muffler: Make----- Various
 Type----- Diffusion and resonance, reverse flow
 Size (body outside)----- Model 2434, 4 x 7-3/4 (oval) x 24; all others 4 x 7-3/4 (oval) x 30
 Exhaust pipe: Type----- Unfluted (welded to muffler) all except 2434.
 Outside diameter----- 2.1
 Tail pipe inside diameter----- 1.81
 Mounting----- Two point rubber suspension

ENGINE COOLING SYSTEM

METHOD OF COOLING

Cylinder cooling----- Full stroke length water jacket around each cylinder.
Cooling system capacity-----16 qts
With heater----- 17 qts
Pressurized cooling system-----Yes
By-pass for recirculation-----
-----Integral with front of block

RADIATOR CORE

Make and type----- Harrison, cellular
Material----- All copper core
Size-- .25 x .56 x 2, regular; .20 x .56 x 2, Powerglide
Frontal area----- 385 sq. in.
Radiator pressure capacity-----7.5 lb/sq. in. (max)
Drain cocks:

Number used and size-----Two, 1/4
(one at bottom of radiator, left front side; one at rear of cylinder block, left side.)

WATER PUMP

Type and drive----- Centrifugal, driven by fan belt
Location----- On front of cylinder and case
Capacity----- 55 gal/minute @ 4000 engine RPM
Impeller type----- Vane
Bearing and shaft assembly:
Lubrication-----Permanent
Bearing, anti-friction-----See pages 171, 172
Seal assembly-----Spring loaded sheet brass encased synthetic rubber and plastic.

ENGINE ELECTRICAL SYSTEM

GENERATOR

Make and model-----Delco-Remy, 1100310
Type----- Two brush, shunt-wound
Rating: Amperes----- 25
Volts----- 12-15
Ventilation----- Pulley fan
Drive----- Fan belt
Pulley size----- 2.88 pitch diameter x 36°V
Armature shaft bearings:
Commutator end----- Plain bushing
Drive end--Anti-friction bearing, see pages 171, 172
Brush spring tension----- 24-32 ounces
Rotation (drive end)----- Clockwise
Generator RPM/MPH-----107 approximately
Car MPH (High gear)----- 26.2 approximately
Maximum Generator Output RPM (Hot)---- 2750 and up
Maximum Engine Output RPM (Hot)----- 1190+
Speed ratio (Generator to engine)----- 2.31:1

RPO 325 GENERATOR EQUIPMENTS

Rating	Delco-Remy Model Number	
	Generator	Regulator
30 ampere	1102014	1118826
40 ampere (Low cut-in)	1106981	1118948

BATTERY

Make, model----- Delco, 25M 50-W
Size----- 10.19 long x 6.75 wide x 8.81 high
Rated voltage-----12
Capacity----- 50 amp hours at 20 hour rate
Bench normal charging rate----- 3.5 amps
Cell arrangement-----6, side by side
Plates per cell----- 9
Terminal grounded----- Negative
Location----- On right hand side of dash, under hood

Continued

10-29-54. Revised: 6-10-55, e - Data revised. x - Data corrected. * - Data added.

40 - ENGINE, SIX CYLINDER

WATER THERMOSTAT

Make----- Harrison
Type----- Bellows operated poppet valve
Location----- In cylinder head water outlet
By-pass for recirculation----- None
Thermostatic action at 29" HG barometric pressure:
Starts to open----- 157°-163°F
Fully open----- 183°F

RADIATOR HOSE

Function	Inlet	Outlet
Location	Cyl head to rad	Rad to water pump
Quantity	1	1
Type	Molded elbow	Compound curve
ID	1.5	1.75
Material	Fabric reinforced rubber	
Spring reinforcement	None	Brass coil spring

ENGINE FAN AND BELT

Make and type----- Own, 4 staggered blades
Diameter----- 17
Pulley size----- 7, pitch diameter: 36°V
Fan to engine speed ratio----- .949:1x
Fan belt:
Material----- Reinforced rubber
Construction----- Molded, one-piece; plain bottom, wrapped or cut sides.
Size----- .375 width; 40.5 approximately pitch length
Angle of V----- 37°-44°

VOLTAGE AND CURRENT REGULATOR

Make and model-----Delco-Remy, 1118945
Location----- LH front fender skirt
Type----- Vibrator
Voltage regulator:
Maximum volts (controlled)----- 14.5
Temperature----- Operating
Average air gap----- .075
Current regulator:
Amperes-----25
Temperature----- Operating
Average air gap----- .075
Cutout relay:
Point closing, volts----- 12.8
Generator armature speed (Hot)----- 1300 RPM
Car MPH (High Gear)----- 11
Average air gap and point gap----- .020

STARTING MOTOR

Make and model-----Delco-Remy, 1107626
Number of field coils----- 4
Rotation (drive end view)----- Clockwise
Brush spring tension----- 30 ounces
Armature shaft bushings:
Drive and commutator ends-----
-----Graphite lubricated, bronze
Testing:

	<u>Lock test</u>	<u>No load test</u>
Amperage draw-----	415	-----65
Volts-----	5.8	-----10.4
Torque-----	12 ft lb	
RPM-----	-----7900	

CHEVROLET 1955 SPECIFICATIONS - PASSENGER

ENGINE ELECTRICAL SYSTEM - Continued

STARTING

COIL

Motor control:

Ignition switch, 4 positions: locked off, unlocked off, on, and start.

Starting operation ----- Turn ignition key to extreme right.

Neutral safety switch (Powerglide only) wired in series with ignition switch and permits operation of motor with transmission control in "Neutral" or "Park" positions only.

Motor drive:

Engagement type ----- Positive shift solenoid
 Starter pinion meshes ----- From front of flywheel
 No. of teeth ----- 9, starter pinion; 168 flywheel
 Gear ratio (starter to flywheel) ----- 18.67:1

DISTRIBUTOR

Make and model ----- Delco-Remy, 1112403
 Current source ----- Generator or battery
 Vacuum control part number ----- 1116089
 New breaker contact opening ----- .016-.021
 Cam angle at .016 point setting ----- 26°-33°
 Breaker arm tension ----- 19-23 ounces

SPARK PLUGS

Make and model ----- AC, 44-5
 Thread size ----- 14mm
 Recommended gap ----- .033-.038
 Recommended torque ----- 15-25 ft lb

SPARK ADVANCE CURVE

Automatic spark advance	Advance begins	Full advance
Vacuum control	4" to 6" Hg	13° to 17° @ 7.5" to 10" Hg x
Centrifugal	450 to 750 RPM	24° to 28° at 3500 RPM and up

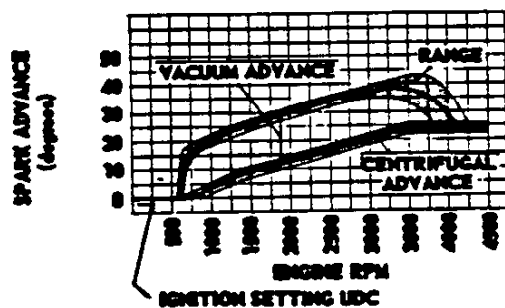

Make and model ----- Delco-Remy, 1115085
 Resistor type ----- External
 Location ----- Engine, right side
 Amperes drawn - 4.0 Eng. stopped; 1.8 idling (500 RPM) e

ENGINE TIMING

Timing spark advance (initial setting):

Engine for 3-Speed or Overdrive ----- On U. D. C.
 Engine for Powerglide ----- On U. D. C.

Timing mark location ----- On flywheel
 Firing order ----- 1-5-3-6-2-4

ENGINE TIMING - Conventional 3-Speed

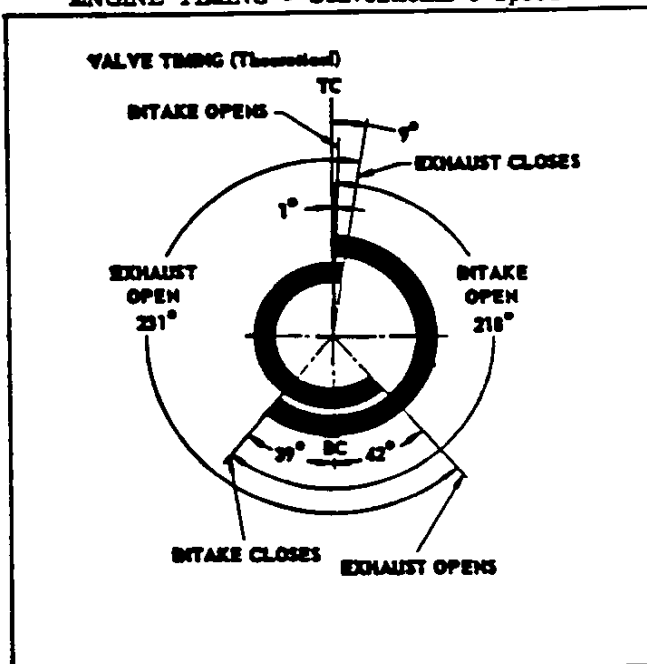

ENGINE TIMING - Powerglide

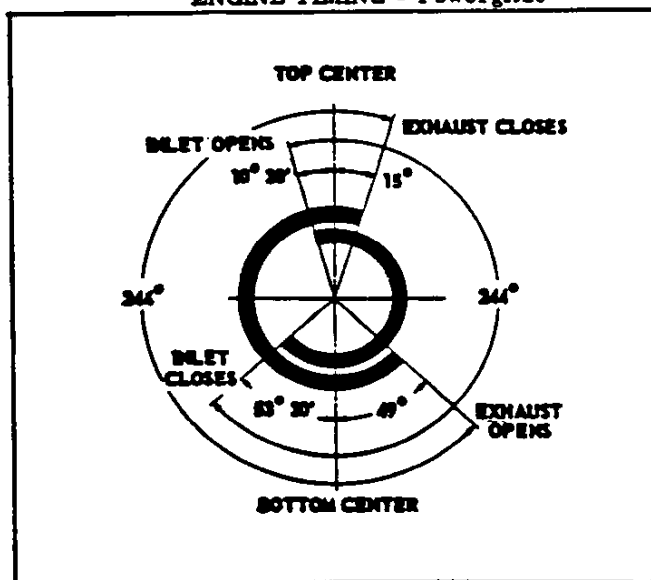

ENGINE - GENERAL

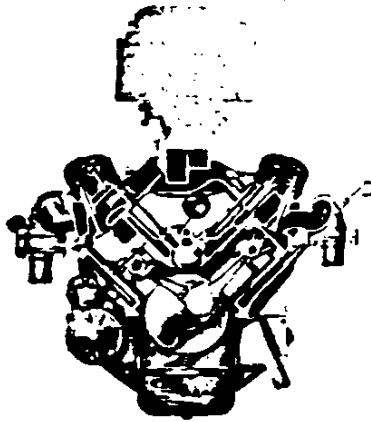

BASIC ENGINE DATA

Engine	8 Cylinder Engine with Conventional or Powerglide transmission	
Piston displacement (cu. in.)	265.0	
Type	Valve-in-head	
Number of cylinders	8	
Bore and stroke (Nominal)	3.75 x 3.00	
Compression ratio	8.0:1	
Taxable (SAE) horsepower	45	
Idling speed (RPM)	475 In Neutral	425 In Drive
Compression pressure @ cranking speed, engine hot (PSI)	160 (or better)	
Dry Weights (Pounds)	Engine	●566 H
	Engine and transmission	●631 ©; ●659 †
Lubrication	Full pressure	
Power plant mounting	4-Point rubber-cushioned, strut-type front mounts & shear-type rear mounts	

ADVERTISED MAXIMUM ENGINE PERFORMANCE

Carburetor	Double barrel		RPO (4-Barrel)
Brake horsepower	Gross	162 @ 4400 RPM	180 @ 4600 RPM
	Net	137 @ 4000 RPM	160 @ 4200 RPM
Torque (ft lb)	Gross	257 @ 2200 RPM	260 @ 2800 RPM
	Net	235 @ 2200 RPM	240 @ 2600 RPM

ENGINE SPEED AND PISTON TRAVEL

Transmission	Conv	3-Speed with overdrive		Powerglide
	3-Speed	O.D. locked out	O.D. locked in	
Rear axle ratio	3.70:1	4.11:1		3.55:1
Tire size	6.70-15-4 Ply			
Crankshaft revs/mile	2790.0	3099.0	2169.0	2677.0
Crankshaft RPM at one MPH	Low & reverse	136.6	151.7	106.1*
	Second	78.1	86.7	60.6
	Direct ‡	46.4	51.6	36.1
Piston travel (ft/mile)	1395.0	1550.0	1085.0	1339.0

ADVERTISED CAR PERFORMANCE

The following information is based on Model 2103, 4-Door Sedan (with and without Powerglide and with a double barrel carburetor) at performance weight (curb weight plus 600 lbs to represent four passengers)

Models	2103	2103 PG
Performance weight (Pounds)	3880 ●	3975 ●
Pounds/gross horsepower	23.95●	24.54●
Pounds/cu. in. displacement	14.64●	15.00●
Gross horsepower/cu. in. displacement	.611●	
Power displacement (cu. ft. /mile) ‡	213.76●	205.27 % ●
Displacement factor (cu. ft. /ton mile) §	110.18●	103.28 % ●

- * - Applicable to low gear only. Overdrive does not function in reverse.
- - Including clutch with Conventional or Overdrive transmission.
- ◎ - Including clutch with 3-Speed transmission. † - Including clutch with Overdrive transmission.
- ‡ - Engine and Powerglide transmission. ‡ - Also known as N/V factor.
- § - Crankshaft rev/mile x piston displacement
1728 x 2

‡ - Power displacement divided by performance weight in tons.
% - These data are computed assuming zero slippage in the torque converter.
10-29-54. Revised: 6-10-55. ● - Data revised.

ENGINE PERFORMANCE

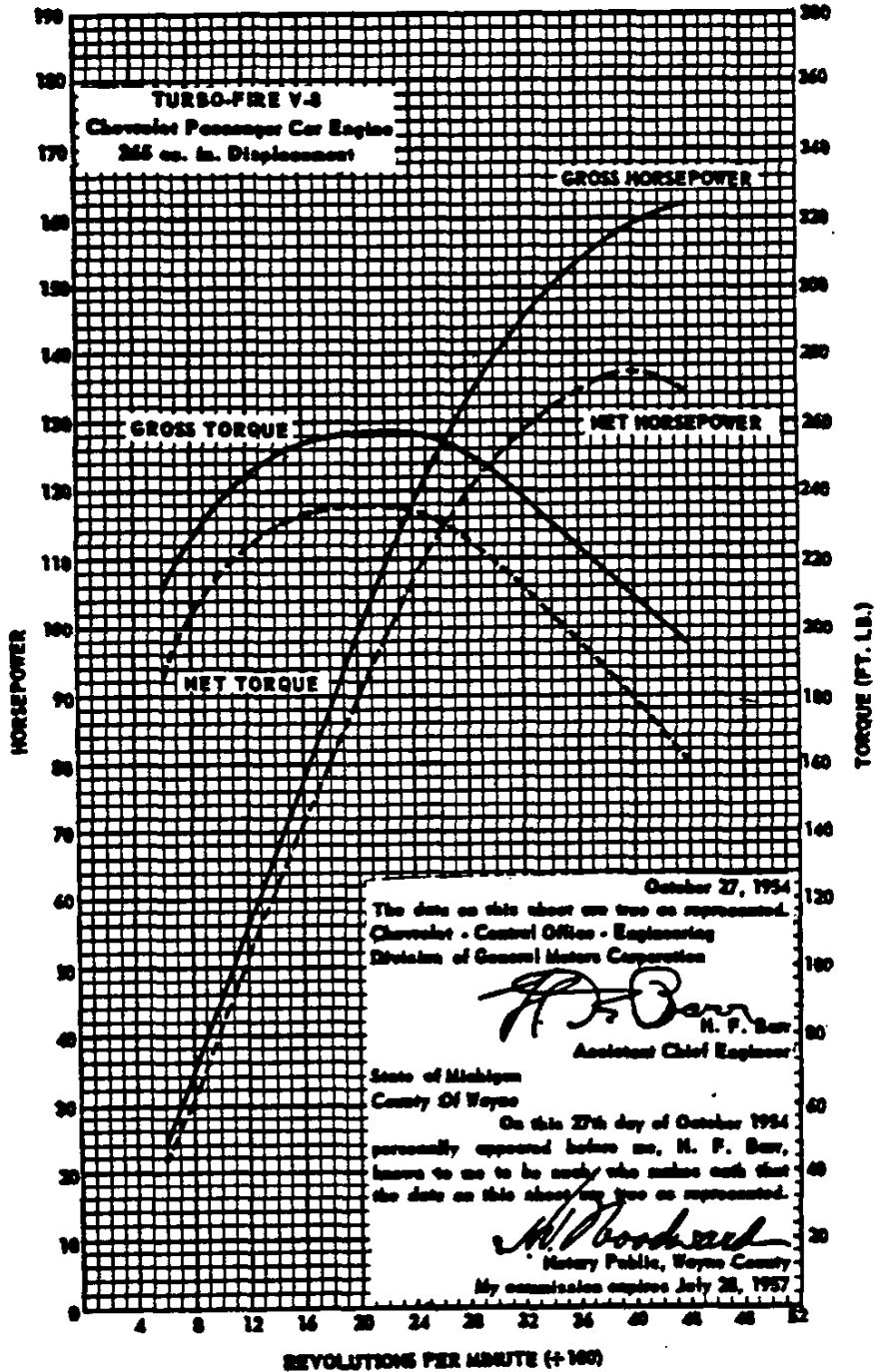

The engine performance curves shown on this sheet are taken from Chevrolet engine test report 16965-89. They represent the full throttle performance of a Turbo-Fire V-8 Chevrolet passenger car engine (265 cu. in. displacement) as obtained from dynamometer test data which were corrected to the standard barometric pressure 29.92" Hg. and the standard temperature of 60°F.

GROSS POWER and TORQUE were obtained in a regular dynamometer test with the dynamometer exhaust system, no fan, generator not charging, and optimum spark advance.

NET POWER and TORQUE were obtained from a dynamometer test simulating actual operating conditions when the engine is in its vehicle. It includes the use of the regular muffler and pipes, the fan in operation and automatic spark advance. The generator is not charging.

10-29-54
CHEVROLET 1935 SPECIFICATIONS - PASSENGER

ENGINE, EIGHT CYLINDER - 43

ENGINE PERFORMANCE

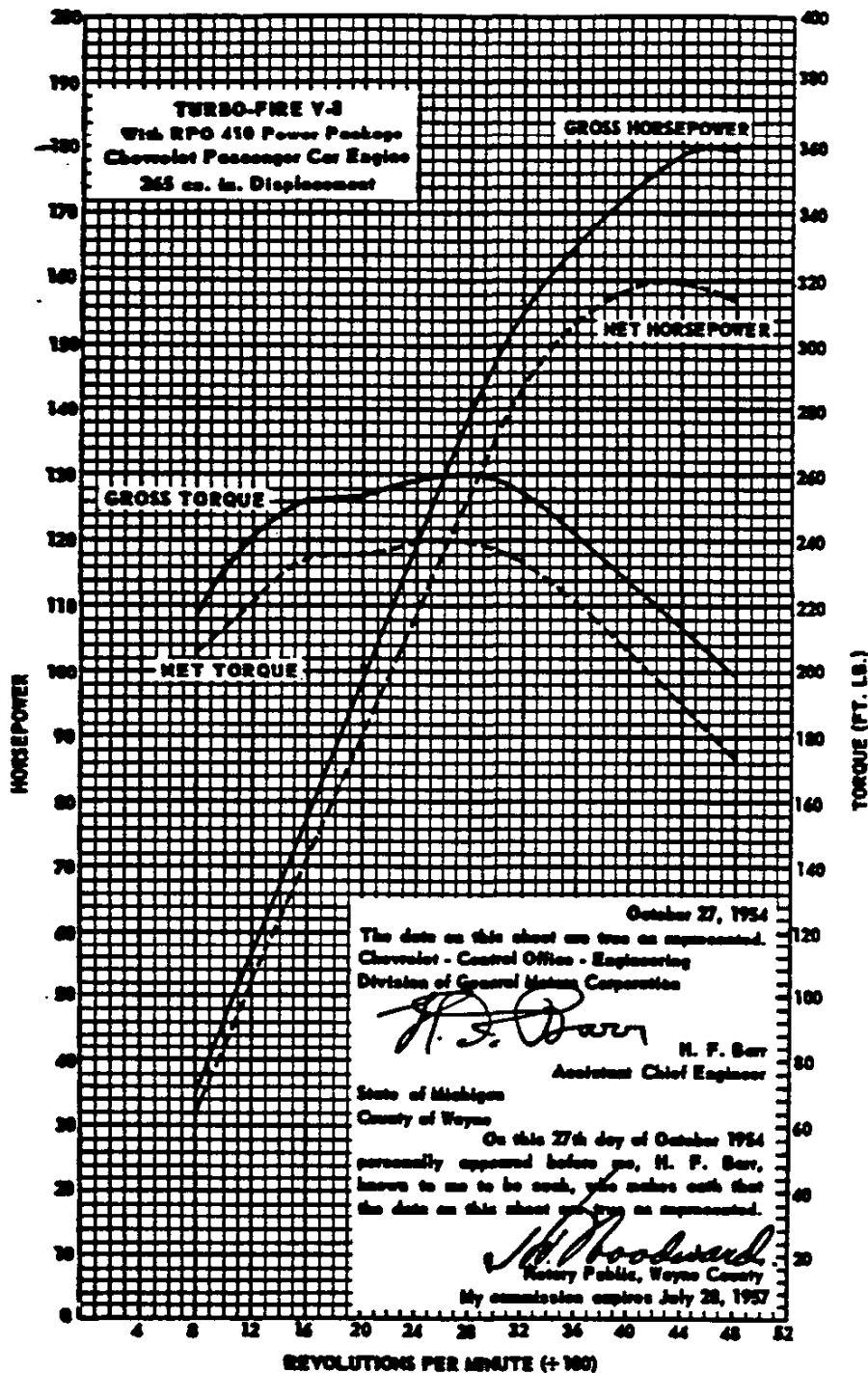

The engine performance curves shown on this sheet are taken from Chevrolet engine test report 16965-89. They represent the full throttle performance of a Turbo-Fire V-8 Chevrolet passenger car engine with RPO 410 power package (265 cu.in. displacement) as obtained from dynamometer test data which were corrected to the standard barometric pressure 29.92"Hg. and the standard temperature of 60°F.

ular dynamometer test with the dynamometer exhaust system, no fan, generator not charging, and optimum spark advance.

NET POWER and TORQUE were obtained from a dynamometer test simulating actual operating conditions when the engine is in its vehicle. It includes the use of the regular muffler and pipes, the fan in operation and automatic spark advance. The generator is not charging.

GROSS POWER and TORQUE were obtained in a reg-

0-29-54
4 - ENGINE, EIGHT CYLINDER

CHEVROLET 1955 SPECIFICATIONS - PASSENGER

CYLINDER CASE AND HEAD
 Material-----Cast alloy iron Offset-----None
 Cylinder head bolt torque-----60-70 ft lbs Bore diameter-----3.7495-3.7515
CRANKSHAFT AND BEARINGS

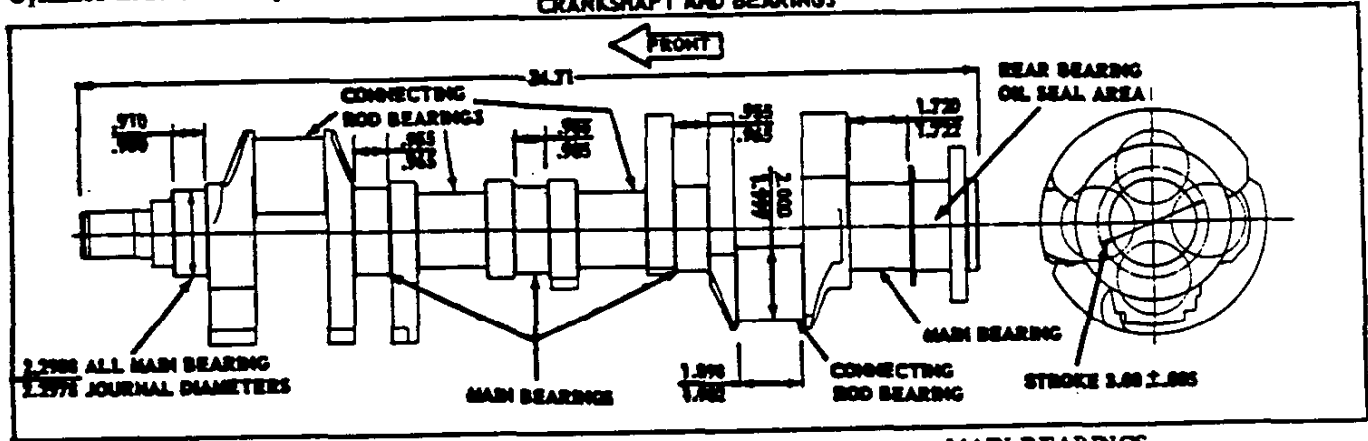

CRANKSHAFT

Material-----Drop-forged steel
 Weight (crankshaft & pilot bearing assembly)-47.75 lbs
 End play-----.002-.006
 Counter weights-----6
 Strokes-----3.00 ± .005

MAIN BEARINGS

Type-----Precision, removable
 Necessary to align ream-----No
 Vertical oil clearance-----.0008-.0034
 End thrust against-----#5 bearing
 Bearing cap bolt torque-----60-70 ft lb
 Material-----.003-.006 babbitt on steel shell

HARMONIC BALANCER
 (Vibration damper)

Type-----
 -----Oscillating (Rubber-floated)
 Crankshaft pulley:
 Pitch diameter-----6.64

Brg	Theo. I. D.*	Eff length ‡	Proj Area §
#1-4	2.3004	.702	1.615 sq. in. each
#5	2.3004	1.160	2.667

* - Journal diameter plus oil clearance.
 ‡ - Overall length minus chamfers.
 § - Based on effective length and theoretical I. D.

CAMSHAFT AND BEARINGS

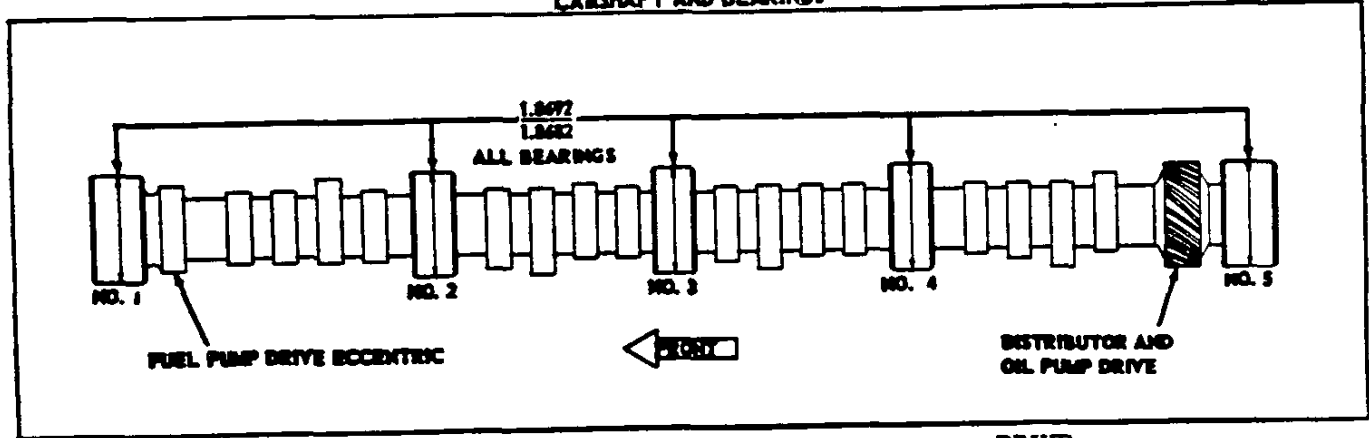

CAMSHAFT

DRIVE

Material-----Cast alloy iron
 Thrust-----Rearward, carried against the face of the crankcase at the front bearing
 Ramp, Inlet:
 (With 3-Speed and Powerglide transmission):
 Opening-----.00300, 7.5° long
 Closing-----.00600, 24° long
 Ramp, Exhaust:
 (With 3-Speed and Powerglide transmission):
 Opening-----.00400, 10° long
 Closing-----.00600, 15° long

Type-----Chain and sprocket, driven from crankshaft

BEARINGS

Material-----Steel-backed babbitt
 Clearance on diameter-----.0015-.0035
 Brg Ream dia Overall length Proj Area

1-4	1.8712	.740	1.385
5	1.8712	.940	1.759

⊙ - Based on ream diameter and overall length shown above.

PISTON-PIN-RINGS

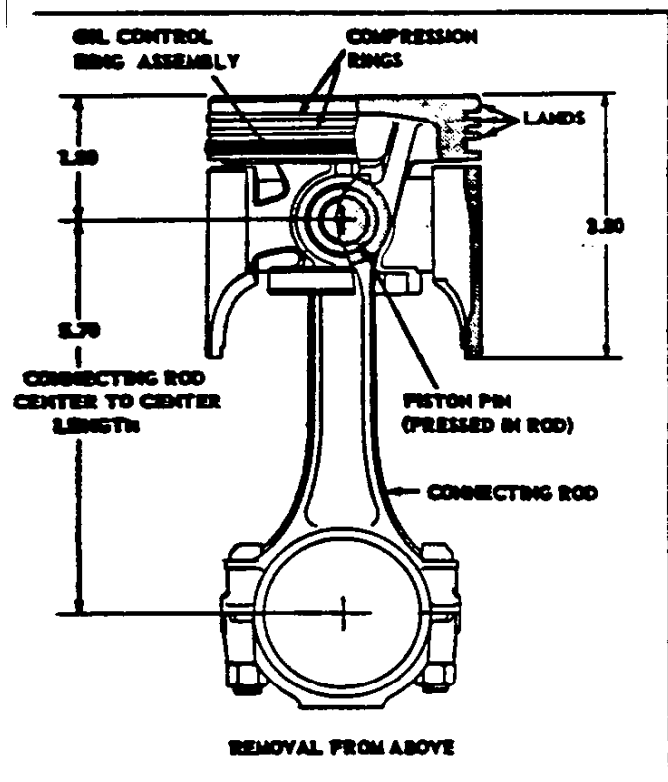

Make and type----- Own, slipper skirt
 Features----- Flat head,
 tin plated, oval with controlled thermo expansion.
 Material----- Cast alloy aluminum with steel struts
 Skirt clearance in cylinder bore----- .0005-.0011
 Top land clearance in cylinder bores ----- .035-.042x
 Lower land clearance in cylinder bore ----- .025-.032x
 Compression ring groove depth ----- .2116-.2180x

Oil ring grooves:
 Depth ----- .2041-.2105x
 Holes, number and size ----- 8, .156 drill
 Minimum head thickness at center ----- .25
 Piston pin bushings ----- None
 Weight of piston ----- 1.173
 Weight of piston, rings, pin and connecting rod upper
 end x 8 (Units/engine) ----- 15.536x

PISTON PIN

Type----- Rod shrunk fit to pin

CONNECTING RODS

Material----- Drop forged steel
 Rod width at piston pin----- 1.007-1.011
 Rod width at crankpin ----- .944-.945
 Crankpin bearing:
 Type----- Precision, interchangeable insert
 Material----- Steel backed with babbitt overlay
 I.D. (Theoretical)----- 2.0013¢
 Effective length----- .817¢
 Clearance in diameter----- .0007-.0028

¢ - Crankpin diameter plus clearance.

¢ - Overall length minus chamfers.

¢ - Based on theoretical I.D. and effective length.

10-29-54: Revised: 6-10-55, © - Data added. x - Data revised.

46 - ENGINE, EIGHT CYLINDER

Material----- Chromium steel (file hard case)
 Diameter----- .9270-.9273
 Length----- 3.110-3.130
 Taper limit in full length----- .0001
 Weight ----- .310
 Clearance in piston ----- .00011-.00029x

COMPRESSION RINGS

Material ----- Cast alloy
 iron, surface treated with a wear-resistant coating.
 Type ----- Thick-wall,
 twist, inside bevel or counter bored, paper-faced.
 Number per piston ----- 2
 Flash chrome plating ----- Top compression ring only
 Width ----- .077-.078
 Wall thickness ----- .177-.187
 Gap clearance ----- .009-.018
 Ring clearance in groove ----- .0012-.0032
 Weight (Each) ----- .039

OIL CONTROL RING

Material and type -- Steel, multi-piece, 2 rails & spacer
 Upper and lower rails ----- Flat spring
 or scaleless temper steel, full chrome plated O.D.
 Spacer (between rails) ----- Flat spring steel
 Gap clearance (On rails) ----- .015-.005
 Ring clearance in groove ----- .0006-.0084
 Weight including expander ----- .025
 Width ----- .181-.188
 Maximum wall thickness (Rails) ----- .168
 Weight:
 Spacer ----- .023¢
 Segment (Each) ----- .025¢

Projected area per rod----- 1.635¢
 Assembly weight (Machined)----- 1.189
 Upper end----- .333
 Lower end----- .856
 Total rotating weight of connecting rods (weight of
 lower end x 8)----- 6.848
 End play----- .008-.014
 Recommended nut torque, with oiled threads-----
 ----- 30-35 ft lbs

VALVE TRAIN

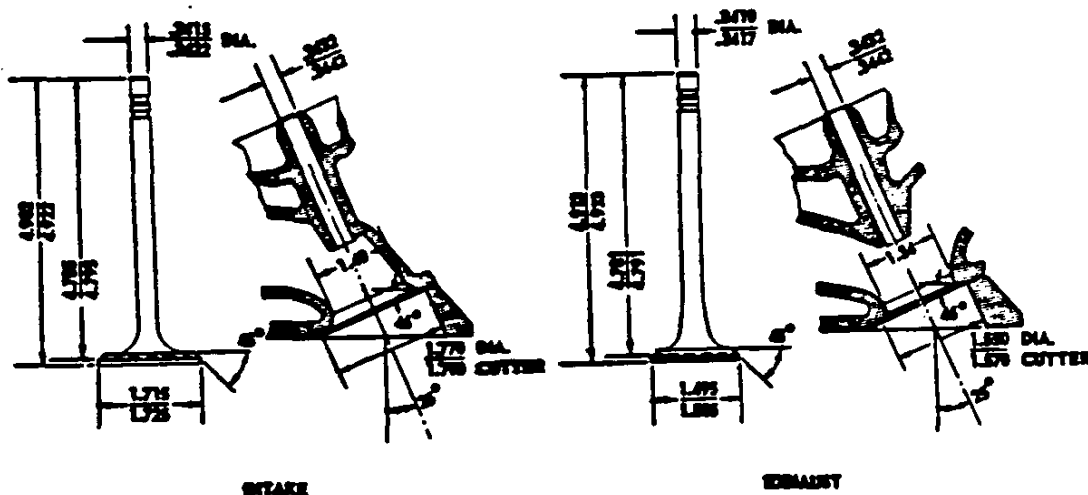

VALVES*

Make ----- Own
Material:

Exhaust valve -----
----- Silchrome, XCR with aluminum dipped seats
Inlet valve ----- Silchrome steel
Stem end style ----- Grooved for keys & oil seal
Lift: With Conventional & Powerglide transmission
Inlet and Exhaust ----- .3336
Face angle (Exhaust and inlet valve) ----- 45°
Distance between valve centers (Measured along center-
line of engine) ----- 1.86
Valve lash (engine normalized)*

Conventional & Powerglide ----- Self-adjusting
* - To normalize engine, run it at fast idle (approx-
imately 600 RPM) until a constant oil temperature is
maintained for a period of five minutes.

VALVE STEM GUIDES

Type ----- Integral with cylinder heads
Clearance with stem:

Exhaust ----- .0015-.0032
Inlet ----- .0010-.0027

VALVE ROCKER ARMS

Type --- Hollow arm with semi-spherical pivot bearing
Material ----- Hardened pressed steel
Mounting ----- Bolted to individual studs
Adjusting nut ----- Tighten to
zero axial movement of push rod plus 3/4 of a turn.
Rocker arm ratio (valve lift to cam lift) ----- 1.5:1
10-29-54. Revised: 6-10-55, e - Data revised. x - Data corrected.
CHEVROLET 1955 SPECIFICATIONS - PASSENGER

VALVE SEATS

Material ----- Cast alloy iron (cylinder head)
Inserts ----- None
Inlet and exhaust seat angle (In head) ----- 46° x
Width in head:
Exhaust seat ----- .062-.093
Inlet seat ----- .035-.060

VALVE SPRINGS

Length and pressure:
Valve closed ----- 1.696 @ 71-79 lbs
Valve open ----- 1.366 @ 145-155 lbs
Free (out of engine) ----- 2.03 approximately

PUSH RODS

Type and material ----- Hollow, welded steel tubing
Push rod seats -----
----- Contained in lifter cylinders.

HYDRAULIC VALVE LIFTERS

Make ----- GM Diesel
Material: Lifter body ----- Cast iron
Lifter plunger & push rod seat ----- Steel
Lift: Exhaust & Inlet ----- .2224
Oil flow - Oil centers the valve lifter oil galleries through
a drilled passage from the camshaft rear bearing
where it flows to the hydraulic lifters. Oil enters
the hydraulic lifters through holes in the side of the
lifter body and plunger. Oil enters the ram chamber
around the steel ball and is delivered to the disc
valve which meters the oil into the hollow push rods.

ENGINE LUBRICATION SYSTEM

GENERAL DATA

Type-----Controlled, full pressure
 Oil passages-----Centralized main gallery, two lifter galleries, various drillings; all integral with block.
 Oil source-----Main oil gallery fed by pump
 Main bearings-----Direct pressure fed from main oil gallery through drilled passages in the cylinder case to the bearings.
 Rod bearings-----Individually fed by oil from main bearings through drilled passages in the crankshaft.
 Cylinder walls and piston pins-----Cross sprayed by pressurized jets of oil from spit holes in connecting rod caps.
 Camshaft bearings-----Direct pressure fed by vertical drillings from main oil gallery.
 Timing chain-----Oil supplied through camshaft bearing and centrifugally fed through slots on sprocket hub
 Hydraulic lifters-----Oil equally distributed by slot at rear camshaft bearing to both lifter galleries which pass through the centerlines of the lifter cylinder bores.
 Locker arms-----Individually lubricated by oil from lifter cylinders through hollow push rods. A hole in the rocker arm allows oil to enter and lubricate the pivot area. Excess oil spills over the outside lip and onto the valve spring which atomizes it for distribution upon the working surfaces.

OIL PUMP

Type and drive-----Gear, from camshaft
 Mounting-----On rear main bearing cap; attached with one bolt and two dowels.

FUEL TANK

Type-----2 stamped pans, seam welded together
 Capacity: Station Wagon & Sedan Delivery ----17 gallons
 All others -----16 gallons
 Mounting-----Supported by two straps attached to underbody between rear axle and rear cross member of frame; all models.
 Filler: Location and access-----Through door in left rear fender; all models.
 Fuel gauge (tank unit): Make & type-----AC, electric; riser pipe & filter integral with unit.
 Filter-----40 mesh metal filter cloth tube mounted on end of riser pipe.

FUEL PUMP

Make and model-----AC, model EN
 Type-----Mechanical (diaphragm) "high reserve"
 Drive-----From camshaft through pump push rod to rocker arm.
 Arm movement-----34 @ camshaft
 Air dome-----Yes (inlet and outlet)
 Pressure at carburetor-----4-5.25 PSI
 Filter-----None (See fuel tank)

CARBURETOR

Make-----Rochester
 Model: Regular -----7008005e
 Powerglide -----7008004e
 Type-----Individually adjusted double barrel, downdraft
 SAE flange size-----1.25
 Size: Venturi throat I.D.-----1.16
 Throttle body I.D.-----1.44
 Choke-----Automatic
 Basic idle adjustment, number of turns-----1-1/2

EXHAUST MANIFOLD

Manifold heat control-----Automatic (thermostat)

AIR CLEANER & SILENCER

Make & type-----AC, oil bath
 Flame arrester-----Yes
 Filter element-----Cactus Fibers

10-29-54. Revised: 6-10-55, e - Data revised.

68 - ENGINE, EIGHT CYLINDER

Intake "Floto-type" with 16 mesh galvanized wire screen
 Relief valve-----In pump cover
 Width of gears-----1.198-1.200
 Capacity (gal/min) -- 4.01-4.22 @ 1170-1200 engine RPM
 Normal oil pressure -- 30 PSI @ 1170-1200 engine RPM

OIL PAN

Type-----Rear sump with welded in baffle
 Capacity-----4.5 qt dry; 4 qt refill
 Drain-----Plug in rear of pan
 Torque, corner bolts-----12.5 to 15 ft lb
 Torque, flange screws-----6 to 7.5 ft lb

MISCELLANEOUS

Oil filler-----Through tube attached to front end of intake manifold.
 Crankcase oil level gauge type-----Rod
 Oil pressure gauge "Tall tale" light in instrument cluster
 Crankcase ventilation: Inlet-----Through breather type oil filler cap on filler tube.
 Outlet-----Through road draft pipe at rear of engine
 Oil filter (RPO 237): Make-----AC
 Capacity (dry)-----1 quart
 Flow-----Approximately 39.5 gal/hr
 Oil cooler-----None

LUBRICANT RECOMMENDED

Temperature: Grade
 Not lower than 32°F-----SAE 20W or SAE 20
 As low as 10°F-----SAE 20W
 As low as minus 10°F-----SAE 10W
 Below minus 10°F-----SAE 5W

FUEL AND EXHAUST SYSTEM

Capacity-----1 Pint
 Used with governor-----No

EXHAUST SYSTEM

Muffler: Make-----Various
 Type-----Diffusion and resonance, reverse flow
 Size (body outside)-----Model 2434 (4 x 7.75 Oval) x 24; all others, (4 x 7.5 oval) x 30
 Cross under pipe-----Flanged for attachment to exhaust manifolds; approximately 2 diameter
 Exhaust pipe: Type-----Untized, welded to muffler; all except 2434
 Outside diameter-----2
 Tail pipe inside diameter-----1.81
 Mounting-----2 Point rubber suspension

HIGH PERFORMANCE PACKAGE (RPO 410)

Carburetor: Make-----Carter
 Model-----WCFB 2351Se
 Type-----Four barrel downdraft, climatic control
 Venturi throat I.D.: Primary side-----1.06
 Secondary side-----.937
 Throttle body I.D.: Primary side-----1.31
 Secondary side-----1.31
 Choke-----Automatic
 Basic idle adjustment, number of turns --- 1/2 to 1-1/2
 Intake manifold: Manifold heat control ----- Automatic (thermostatic)
 Dual exhaust system: Muffler: Make-----2-Various
 Type-----Diffusion and resonance, reverse flow
 Size (Body outside)-----4.25 x 8 x 24
 Exhaust pipe O. D.-----2 (each)
 Tail pipe I.D.-----1.81 (each)
 Suspension -- Individually rubber insulated mountings
 Air cleaner & silencer: Make and type -- AC oil bath, high air intake capacity
 (Other information same as regular)

ENGINE COOLING SYSTEM

METHOD OF COOLING

Cylinder Cooling ----- Full stroke length water jacket around each cylinder.
 Cooling system capacity ----- 16 qts; with heater 17 qts
 Pressurized cooling system ----- Yes
 By-pass for recirculation ----- Integral with right hand water pump distribution arm.

WATER PUMP

Type and Drive ----- Centrifugal, driven by fan belt
 Location ----- At front center of cylinder and case
 Distribution arms ----- One per bank
 Capacity ----- 44.5 gals/min @ 4000 Engine RPM
 Impeller type ----- Vane
 Water pump and fan bearing and shaft assembly:
 Lubrication ----- Permanent
 Bearing, anti-friction ----- See pages 171, 172
 Seal assembly ----- Spring-loaded brass encased synthetic rubber and plastic.

RADIATOR CORE

Usage	Regular	Powerglide
Make & type	Harrison; cellular	
Model	3133044	3133045
Material	All copper	
Cell constant & core thickness	.25 x .56; 2	.22 x .56; 2
Frontal area	357 sq. in.	355 sq. in.
Radiator Pressure cap	7.5 lbs/sq. in. (Max.)	
Radiator drain cock	Size .25; location, at bottom left front side	

ENGINE ELECTRICAL SYSTEM

GENERATOR

Make and model ----- Delco-Remy, 1100310
 Type ----- Two brush, shunt-wound
 Rating
 Amperes ----- 25
 Volts ----- 12-15
 Ventilation ----- By pulley fan
 Drive ----- By fan belt
 Pulley size ----- 2.88PD x 36°V
 Armature shaft bearings:
 Commutator end ----- Plain bushings
 Drive end-Anti-friction bearing, see pages 171, 172
 Brush spring tension ----- 24-32 ounces
 Rotation (drive end) ----- Clockwise
 Generator RPM/MPH ----- 107 approximately
 Car MPH (High gear) ----- 26.5 approximately
 Maximum Generator Output RPM (Hot) ----- 2750 and up
 Maximum Engine Output RPM (Hot) ----- 1190
 Speed ratio (Generator to engine) ----- 2.31:1

RPO 325 GENERATOR EQUIPMENT

Rating	Delco-Remy Model Number	
	Generator	Regulator
30 amp	1102014	1118826
40 amp (Low cut-in)	1106981	1118948

BATTERY

Make and model ----- Delco, 2SM50-W
 Size ----- 10.19 long x 6.75 wide x 8.81 high
 Rated voltage ----- 12
 Capacity ----- 50 amp hours @ 20 hour rate
 Bench normal charging rate ----- 3.5 amps
 Cell arrangement ----- 6, side by side
 Plates per cell ----- 9
 Terminal grounded ----- Negative

10-29-54. Revised: 6-10-55, ● - Data added x - Data revised. ♦ - Data corrected.

WATER THERMOSTAT

Make ----- Harrison
 Type ----- Bellows operated poppet valve
 Thermostat housing ----- At front center of intake manifold
 By-pass for recirculation ----- None
 Thermostat action at 29"Hg. barometric pressure.
 Starts to open ----- 157°-163°F
 Fully open ----- 183°F

RADIATOR HOSE

Function	Inlet	Outlet
Location	Cylinder Head To radiator	Radiator to Water pump
Quantity	1	1
Type	Molded elbow	Compound curve
ID	1.50	1.75
Material	Fabric reinforced rubber	
Spring reinforcement	None	Brass coil spring

ENGINE FAN AND BELT

Make and type ----- Own, 4 staggered blades
 Diameter ----- 17
 Pulley size ----- 7PD, 36°V
 Fan to engine speed ratio ----- 949:1
 Fan belt:
 Material ----- One-piece reinforced rubber with wrapped or cut molded sides.
 Size ----- .38 width, 54.22 approximate pitch length
 Angle of V ----- 37°-44°

Location -----
 ----- On right hand side of dash under hood

VOLTAGE AND CURRENT REGULATOR

Make and model ----- Delco-Remy, 1118945
 Location ----- Front fender skirt, LH
 Type ----- Vibrator
 Voltage regulator:
 Volts ----- 14.5
 Temperature ----- Operating
 Average air gap ----- .075
 Current regulator:
 Amperes ----- 25
 Temperature ----- Operating
 Average air gap ----- .075
 Cutout relay:
 Point closing: Volts ----- 12.8
 Generator armature speed (Hot) ----- 1300 RPM
 Car MPH (high gear) ----- 11 approximately
 Average air gap and point gap ----- .020

STARTING MOTOR

Make and model ----- Delco-Remy, 1107627x
 Number of field coils ----- 4
 Rotation (drive end view) ----- Clockwise
 Brush spring tension ----- 30 ounces
 Armature shaft bushings:
 Drive and commutator end -----
 ----- Graphite lubricated, bronze
 Testing
 Amperage draw ----- Lock Test 415 No load test 65
 Volts ----- 5.8 ----- 10.4
 Torque ----- 12 ft lb
 RPM ----- 8900x

Continued

10-29-54. Revised: 6-10-55, ● - Data added x - Data revised. ♦ - Data corrected.

ENGINE ELECTRICAL SYSTEM - Continued

STARTING

Motor control:

Ignition switch, 4 positions: locked off, unlocked off, on, start

Starting operation -----

----- Turn ignition key to extreme right

Neutral safety switch (Powerglide only) -----

----- Wired in series with ignition switch

and permits operation of motor with transmission

control in "Neutral" or "Park" positions only.

Motor drive:

Engagement type ----- Positive shift solenoid

Start pinion meshes ----- From front of flywheel

No. of teeth ----- 9, starter pinion; 168 flywheel

Gear ratio (starter to flywheel) ----- 18.67:1

SPARK PLUGS

Make and model ----- AC, 44-5

Thread size ----- 14mm

Recommended gap ----- .033-.038

Recommended torque ----- 20-25 ft lb

DISTRIBUTOR

Make and model ----- Delco-Remy, 1110847

Current source ----- Generator or battery

New breaker contact opening ----- .016-.021

Cam angle @ .016 setting ----- 26°-33°

Breaker arm tension ----- 19-23 ounces

Vacuum control ----- Integral with distributor

COIL

Make and model ----- 1115083e

Resistor type ----- External

Location ----- At rear of intake manifold

SPARK ADVANCE CURVE

Automatic spark advance	Advance begins	Full advance
Vacuum control	5" to 7" Hg	25.5° to 29.5° at 13.5" to 16.25" Hg
Centrifugal	450 to 800 RPM	30° to 34° at 3600 RPM and up

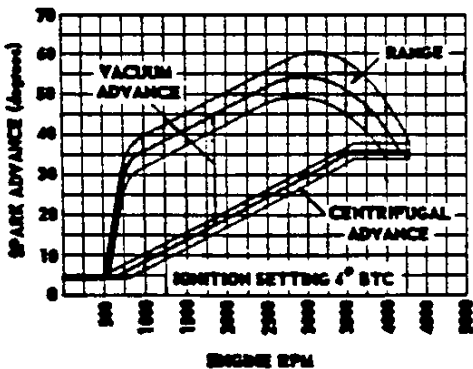

ENGINE TIMING

Timing spark advance (initial setting):

Engine with 3-speed or PG transmission ----- TC

Timing indicator ----- Pointer on crankcase front cover aligns with mark on damper.

Firing order -----

1-8-4-3-6-5-7-2 (Cylinders are numbered from

front of engine, odd numbers to left (driver's)

bank and even numbers to right (driver's) bank)

ENGINE TIMING - 3-Speed & Powerglide

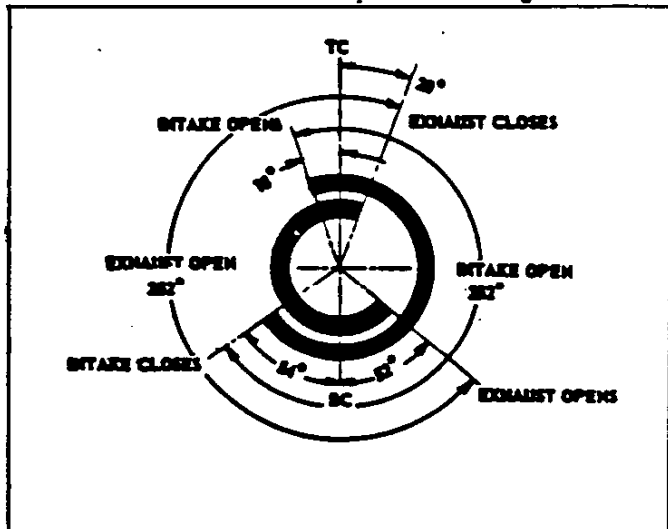

10-29-54. Revised: 6-10-55, e - Data revised.
50 - ENGINE, EIGHT CYLINDER

CLUTCH

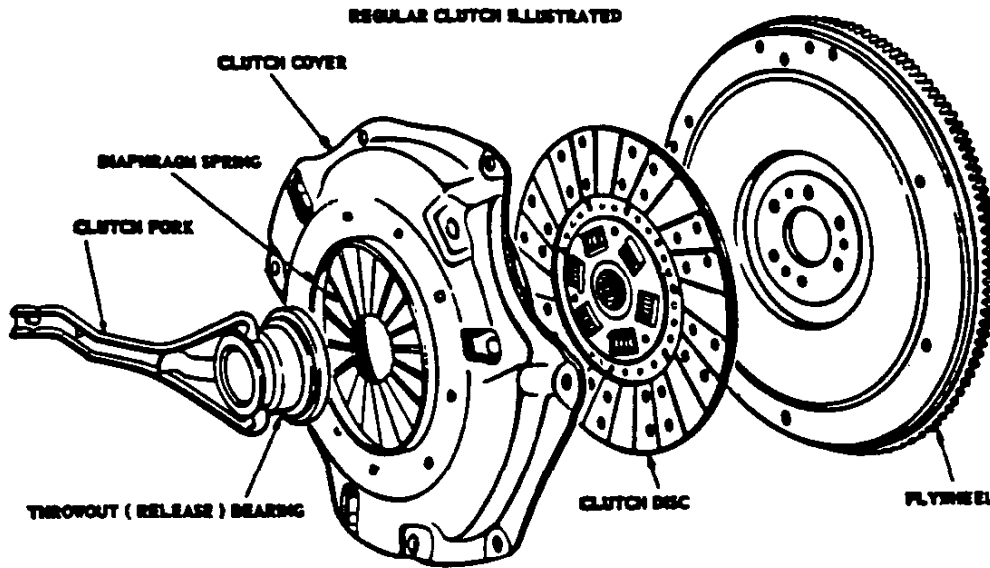

ITEM		REGULAR CLUTCH 6 Cylinder	REGULAR CLUTCH 8 Cylinder	HEAVY DUTY CLUTCH 6 and 8 Cylinder Engine	
Type		Single dry plate			
Rated torque capacity		228 ft lb	238 ft lb	282 ft lb	
Semi-centrifugal		No			
Vacuum control or fluid coupling		None			
Drive		Direct to flywheel face			
Ventilation		Vaness cast in pressure plate			
Diaphragm springs	Pressure in flat position	1325-1450		1450-1550	
	Material	Spring steel, heat treated			
	Pressure levers	18, integral with spring			
Driving members		Two (Flywheel and pressure plate)			
Driven disk	Type	One, spring cushioned plate with two molded facings			
	Vibration insulation	Six cushion springs in hub			
	Facings	Material	Molded asbestos composition		
		Outside dia	9.5	10	11
		Inside dia	6		
Area		85.22 sq. in. (both facings)	100.53 sq. in. (both facings)	123.7 sq. in. (both facings)	
	Thickness	.132-.138		.130-.136	
Bearings	Throw out (Release)	Type, make, no.	Anti-friction bearings; see pages 148-151		
		Lubrication	Packed for life		
	Pilot (in rear end of crank- shaft)	Make and no.	Chevrolet 412562		
		Type	Sintered graphite-bronze bushing. Oil-impregnated		
		I. D.	.5915-.5925		
		O. D.	1.0935-1.0945		
	Width	.740-.760			
	Lubrication	Self			
Controls	Clutch fork type	Case hardened pressed steel, ball pivot mounted			
	Pedal mounting	Pendant from brace on dash			
Flywheel	Material	Cast alloy iron -			
	Flywheel bolt torque	50-65 ft lb			
	Weight (With ring gear)	6 cylinder engine, 31 lb; 8 cylinder engine, 29 lbs			
	Ring gear type	Steel, shrunk on			
	Ring gear teeth - No. & size	168, .480-.490 wide, 14 PD (9 teeth on starter pinion)			
Clutch attachment to flywheel		6 bolts			

10-29-54, Revised: 11-12-54; 6-10-55, e - Data corrected.
CHEVROLET 1955 SPECIFICATIONS - PASSENGER

3-SPEED TRANSMISSION

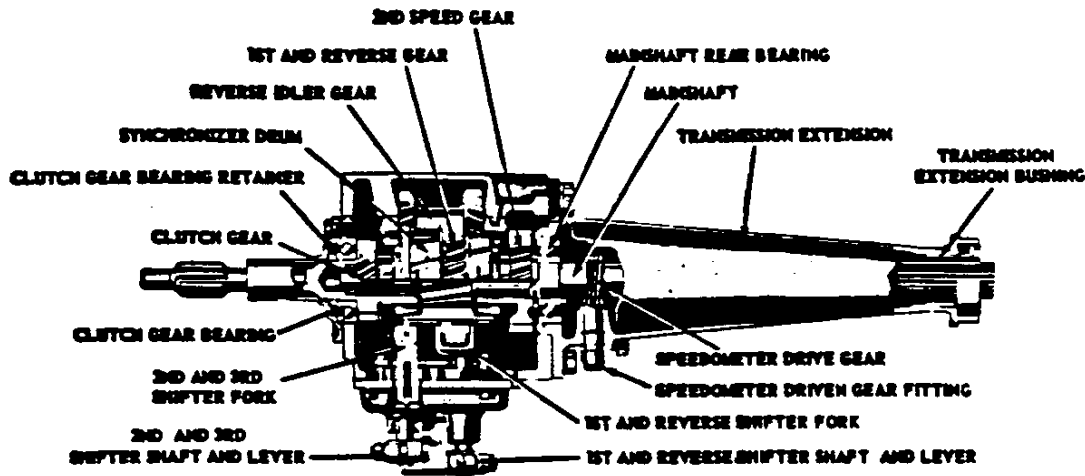

TOP VIEW OF TRANSMISSION AND EXTENSION

ITEM	Regular 8 Cylinder RPO 221 Taxicab RPO 330		
Make and type	Own, 3-speed synchro-mesh, manual shift		
Gearshift control, type and location	Remote, lever mounted on steering column		
Input torque capacity	220 ft lb		
Gear	Type	All helical	
	Material	Forged steel, hardened	
	Synchronization	2nd and 3rd	
	Constant mesh speeds	2nd	
	Sliding gears	1st and Reverse	
	Gear Ratios	Forward	1st 2.94:1 2nd 1.68:1 3rd Direct
		Reverse	2.94:1
Bushing Reverse idler		Optional materials	Rolled sheet bronze, ball-indented Steel-backed bronze, ball-indented
		No. used and size	Two, .7515-.7525 ID x .75 long
Transmission extension	Material	Steel-backed babbitt, grooved	
	Size	1.504-1.506 ID x 1.00 long	
Second Gear Bearing	Type	Gear L. D. Anti-Friction coated, turns on main shaft	
Speedometer gears	Tooth pitch	30	
	Teeth driving & driven	8 and 22	
Lubricant	Type recommended	SAE 90 transmission or mineral oil lubricant	
	Capacity	2 Pints e	
Oil seal (Transmission extension)		Steel encased double seal of spring-loaded Synthetic rubber and felt	
Anti-friction bearings		See pages 148-151	

OVERDRIVE TRANSMISSION - RPO 315

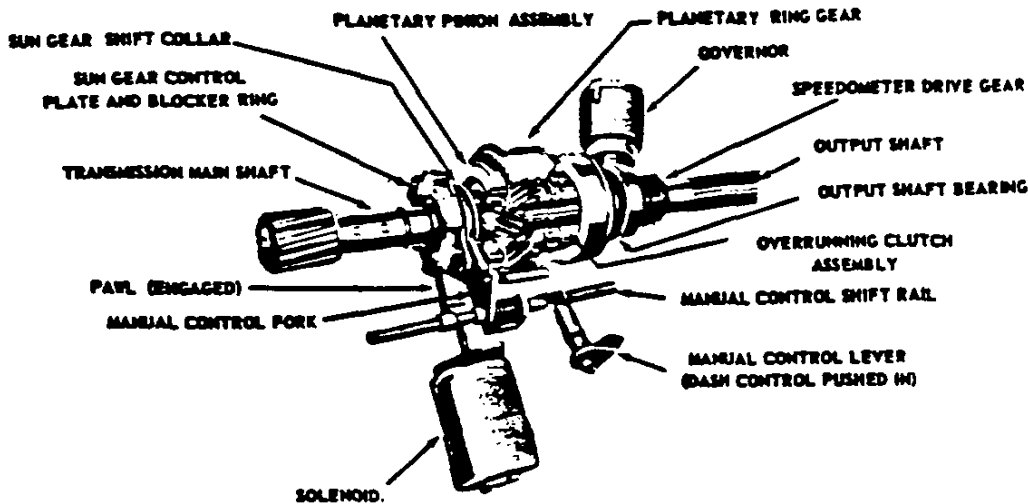

Type ----- 3-Speed Synchromesh with 3-pinion planetary drive unit. The drive unit with its integral mainshaft replaces the mainshaft and extension of the regular 3-Speed transmission.

Lockout switch ----- Manually controlled by "pull-type" cable located under instrument panel to right of steering column. With handle fully extended, overdrive is disengaged.

Kick down switch --- Located on accelerator linkage. Pedal pressure thus controls overdrive operation.

Cut-in speed ----- Approximately 31 MPH.

Cut-out speed ----- Approximately 27 MPH.

GEAR RATIOS

Overdrive Unit	Locked Out	Locked In
First	2.94:1	2.058:1
Second	1.68:1	1.176:1
Third	Direct	0.70:1
Reverse	2.94:1	

Speedometer gears:

Tooth pitch ----- 30
Teeth (driving and driven) ----- 8 & 24

Lubricant:

Type -- SAE 90 transmission or mineral oil lubricant

Capacity:

Transmission ----- 2 pints
Overdrive unit ----- 1 pint
Total ----- 3 pints

WHEELS AND TIRES

WHEEL AND HUB CAP

Make and type	Own, short spoke disc
Attachment to hub	5 bolts, .438-20
Bolt circle diameter	4.75
Offset and rim size	.562, 15 x 5K
Paint and striping	See Exterior Colors and Finishes
Hub Cap (1500, 2100)	Stainless steel, 10.69 diameter
Wheel disc (2400)	Stainless steel, 15.28 diameter



TIRES (Tubeless)

Tire size and ply rating	Regular or RPO Equipment	Tire and Rim Association Standards *				Recommended Pressure	
		Loaded Rolling radius	Loaded, Rev Per Mile	Load Capacity each tire	Front	Rear	
		6.70-15-4 black sidewall	Regular	13.40	754	925	24
6.70-15-4 White & Black Sidewall	RPO All						
6.70-15-6 Black or white & Black sidewall	RPO All	13.40	754	1055	30	30	

* - U.S. Rubber Company standards shown. Tires furnished are U.S. Goodrich, and Firestone.
10-29-54. Revised: 12-8-54, 6-10-55, 8-1-55. e-Data added. x-Data Corrected

AUTOMATIC TRANSMISSION (RPO 313)

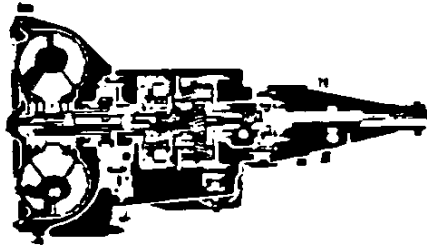

GENERAL DATA

Make and type--- Own, automatic hydraulic torque converter with planetary gear system for reverse & low
 Rated torque capacity-----204 ft lb (input)
 Converter maximum torque ratio (at stall)----- 2.1:1
 Total transmission torque multiplication (converter x planetary gear ratio):
 Maximum overall transmission ratio----- 3.82:1
 Low range (auto or manual)-----3.82:1 to 1.82:1
 Reverse range----- 3.82:1 to 1.82:1
 Oil type-----Automatic transmission fluid, type A
 Oil capacity-----11 quarts; refill, 5 quarts
 Oil cooler-----Integral with radiator assembly and connected to transmission by inlet & outlet pipes.

Selector lever:
 Location-----On steering column
 Operation-----
 Actuates manual valve in hydraulic control system.
 Positions (Indicated in quadrant on instrument panel)
 Five; (Left to Right), Park - Neutral - Drive - Low - Reverse

Parking lock:
 Type-----Pawl and gear
 Operation-----
 Applied by selector lever through positive linkage.
 Flywheel-----Steel stamping with welded-on ring gear
 Representative shift points:

	Miles per hour	
	Upshift	Downshift
Low	12-14	9-11
High (at detent)	30-45	14-17
High (through detent)	48-52	45-50

HYDRAULIC TORQUE CONVERTER

Type-----Three element
 Driving member (pump)----- Sheet metal, multi-vane type, spot welded to torque converter housing. The housing cover is bolted to the flywheel.
 Driving member (turbine)-----
 Sheet metal, multi-vane type, supported by torque converter housing cover. Turns independently of housing. Splined to input shaft.
 Reaction member (stator)-----Aluminum air foil type, supported on a stationary sleeve by an overrunning clutch of cam and roller design.

HIGH CLUTCH

Type----- Multiple-disc
 Discs:
 Driving; number and type-----
 Four, steel with cork and paper facings, bonded.
 Driven; number and type-----Five, steel
 Low brake band-----
 -- Double-wrapped design (Linked circular segments)
 Low band servo:
 Type----- Piston, one release spring

Adjustment-----Threaded anchor bolt

PLANETARY GEAR UNIT

Type----- Compound planetary
 Gear ratios:
 Cruising range-----1:1 (Direct drive)
 Low range-----1.82:1
 Reverse-----1.82:1
 Reverse brake band----- Single strap
 Reverse band servo:
 Type-----Piston with release spring and inner cushioning spring.
 Adjustment-----Threaded anchor bolt

HYDRAULIC CONTROLS

Manual valve:
 Material-----Hardened steel
 Type-----Spool
 Operated by----- Selector lever through linkage
 Check valve:
 Material-----Flat spring steel
 Type-----Two passage check, hair pin shaped
 Pressure regulator valve:
 Type-----Spool
 Pressure range:
 Automatic cruising----- 85-94 PSI
 Automatic low----- 85-94 PSI
 Manual low----- 85-94 PSI
 Reverse-----166-194 PSI
 Neutral & Park (Engine idling)----- *51-59 PSI

Reserve booster valve:
 Type-----Spring loaded, working in conjunction with pressure regulator valve.
 Location----- In main valve body
 Operation-----
 Elevates pressure for reverse operation.

Thermostatic by-pass valve:
 Location----- Servo cover
 By-pass closes-----210°-240°F

Automatic shift valve:
 Type----- Hydraulic spool valve controlled by throttle valve and governor.

Throttle valve:
 Type----- Spool
 Actuation-----Accelerator linkage
 Location-----In automatic shift valve body
 Operation-----Regulates main line oil pressure to automatic shift valve.

Governor:
 Type-----Centrifugal
 Drive----- From transmission output shaft
 Location-----
 Accessible from rear of transmission, left side
 Operation-----Regulates oil pressure from rear oil pump to automatic valve.

* - At maximum idling speed of 425-475 RPM
 10-29-54

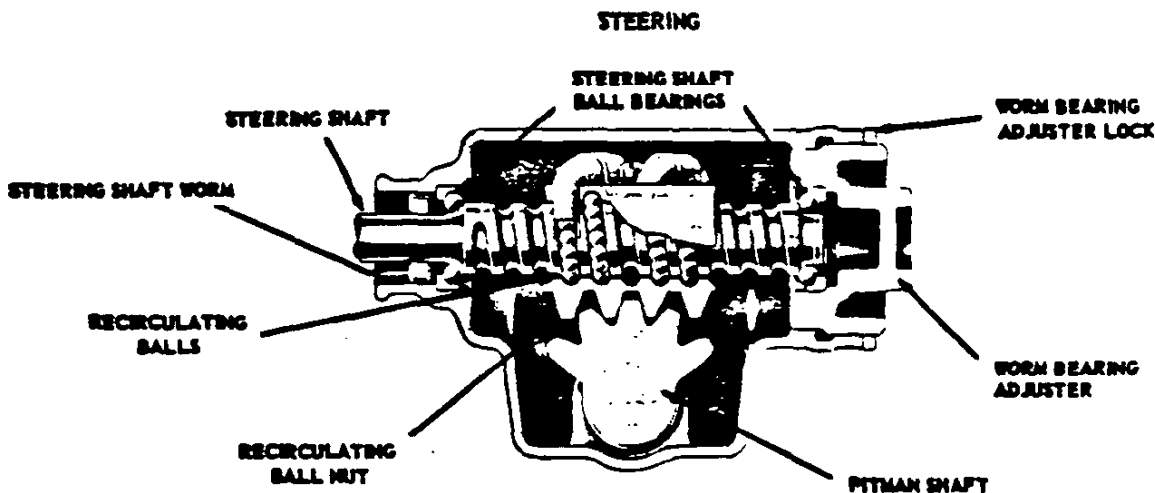

STEERING GEAR

Make and type-----
 -----Saginaw semi-reversible re-circulating ball
 Ratio (gear)----- 20:1
 Overall ratio (gear plus linkage)----- 25.7:1
 Mounting----- On frame side member
 Anti-friction bearings-----See pages 171, 172
 Steering mainshaft diameter----- .75
 Steering column diameter----- .2
 Lubricant recommended-----
 Steering gear or "Multi-Purpose" gear lubricant.
 Worm & sector adjustment----- Fully adjustable
 Sector mounting type-----Straddle mounted
 Pitman shaft:
 Material-----Drop forged steel
 Mounting----- Straddle mounted
 Diameter----- 1.13
 Bushings:
 Number-----3
 Material-----Cast bronze
 ID-----1.13
 Length:
 Outer & intermediate-----1.38
 Inner-----.844

STEERING WHEEL

Diameter-----18
 One-fifty model-----Two spokes with horn button
 Two-ten model-----Two spokes with horn blowing ring
 Bel-Air model-----Three spokes with horn blowing ring
 Number of turns of wheel for full right to left travel
 of front wheels (To steering gear stop)----- 5.34



TURNING DIAMETERS

A
 Right & left turn 38 ft
 B
 Right & left turn 41 ft
 Nominal figures based
 on tests made at
 General Motors Proving
 Ground

POWER STEERING (RPO 324)

Generator:
 Make & model----- Delco-Remy, 1102020
 Pulley size----- 3.32 PD, 36°V
 Speed ratio (Generator to engine)----- 2.00:1
 Belt size:
 6 cylinder---.375 wide; 41.33 approx. pitch length
 8 cylinder---.375 wide; 54.71 approx. pitch length
 Regulator, make & model----- Delco-Remy, 1118826
 Pump:
 Make & type-----Saginaw, vane type hydraulic
 Mounting----- On rear of generator
 Drive-----
 From splined extension of generator drive shaft.
 Fluid reservoir-----
 ----- Integral with pump. Screen in filler neck.
 Fluid type & capacity-----
 Automatic transmission fluid type A; 1.5 pints.
 Fluid travel-----Through hoses from pump
 to control valve to power cylinder and return.
 Maximum pressure-----750-800PSI
 Control valve (Integral with steering relay rod):
 Make & type-----Saginaw, hydraulic
 Attached to-----Pitman arm
 Power cylinder:
 Make & type-----Saginaw, hydraulic
 Attachment-----To
 frame and connecting with steering relay rod.
 Power application----- Directly to
 steering linkage; double-acting piston in power cylinder
 is actuated by control valve after approximately
 3 pounds of pressure is exerted at the steering
 wheel.
 Overall steering ratio----- 23.3:1
 Steering assistance provided-----
 Up to 80% (at 8 pounds steering wheel rim pull)
 STEERING LINKAGE
 Type----- Relay
 Steering idler:
 Material----- Drop forged steel
 Mounting-----Pivot bracket
 mounted to front suspension cross member.
 Tie rods-----Left & right; adjustable
 Steering relay rod (drag link)----- Yes
 Pitman arm type & matl.--One-piece, drop forged steel

HEADLIGHTS

Make & type-----Guide, sealed beam
 Location-----In front fender face
 Sealed beam unit diameter-----7
 Dimmed by-----Fast switch
 High beam indicator-----
 -----Chevrolet emblem in speedometer face

PARKING LIGHTS

Location-----Below headlights in front fender face
 Bulb replacement-----Remove screws in plastic lens
 Controlled by-----Main switch

TAIL AND STOP LIGHTS

Make and type-----
 Guide; tail and stop light combined in one unit.
 Stop light switch-----Mechanical, mounted on dash to instrument panel brace.

DIRECTION SIGNAL

(Factory optional accessory)

Make-----Guide
 Type-----Flasher, front & rear; self-canceling
 Front-----Double filament bulb replaces single filament parking lamp.
 Rear-----Uses stop lamp bulb
 Turn indicators on dash-----
 -----Arrows in instrument cluster face.

REAR LICENSE LIGHTS

All models-----
 One housed in each rear bumper guard inner face.

PASSENGER COMPARTMENT LIGHTS

Convertible-----Dual courtesy lamps, one under instrument panel each side.
 Sport Coupe-----Dual rear compartment lamps one located high on each rear side quarter panel.
 Station Wagon (2429)-----
 -----Dual lamps, one located on each pillar directly behind front door operated by dome light switch or by a control to right of tailgate.
 All others-----Single dome light located approximately at center of roof.
 Manually controlled by-----Main switch
 Automatically controlled by-----
 -----Opening front and rear doors in the Bel Air Series; front doors only in the Two-Ten Series. No automatic control in the One-Fifty Series.

DUAL CIRCUIT BREAKER

Type & location-----Bi-metal thermal elements incorporated in main switch.
 Capacity (each circuit)-----15 amperes

TOOLS

Jack (column & bracket serves as spare wheel support; base as wheel clamp. All models except station wagons & sedan delivery)
 Capacity-----1200 lb
 Height-----28, raised; 5, lowered
 Wheel wrench-----Designed to serve also as jack handle and hub cap remover.
 10-29-54. Revised: 6-10-55, e-Data added.
 56 - LIGHTS, HORNS, TOOLS

LIGHTS

INSTRUMENT PANEL LIGHTING

Instrument cluster:
 Temperature gauge-----Clear white light
 Gasoline gauge-----Clear white light
 Speedometer dial-----Clear white light
 High beam indicator-----Red when lighted
 Oil pressure indicator-----Word "OIL" (black letters on red ground) visible when oil pressure drops below safety level.
 Generator-----Word "GEN" (black letters on red ground) visible when generator is not charging.
 Turn indicators-----Green when lighted
 Powerglide shift indicator-----Clear white light
 Others:
 Ignition lock-----Clear white light
 Glove compartment-----Clear white light. When switch is actuated by opening compartment door in the Two-Ten and Bel Air Series only.

MAIN SWITCH

Three position "pull" type switch mounted on instrument panel. A rheostat operated by rotating the switch knob controls the brightness of the instrument panel lights. Passenger compartment lights are controlled by a detent in the rheostat when switch knob is rotated to extreme travel counter-clockwise.

BULBS

		Used in	Quantity	Trade No.	Power
Headlights	Upper beam		2	4400*	50W
	Lower beam				40W
Parking lights				67	3CP
Instrument cluster			3		
Oil pressure indicator				57	2CP
PG shift indicator					
Glove compartment			1	67	3CP
Clock					
Cigarette lighter				53	1CP
High beam indicator					
Ignition lock					
Passenger Compartment Lights	Convertible		2	89	6 CP
	Sport Coupe & 2429 e			90	
	All others			1004	
License plate light				67	3CP
Tail & stop lights	Tail		2	1034*	4CP
	Stop				
Directional Signal (FOA)	Rear	Stop lamp used			32CP
	Front		2	1034*	4CP
	Front parking				
	Dash indicator				

* - Double filament bulb

HORNS

Make-----Delco-Remy
 Type-----Vibrator
 Number and location-----
 -----Two, attached to radiator side supports.
 Relay in circuit-----Yes
 Current: High note-----9 amperes
 Low note-----10 amperes

CORVETTE - Supplement

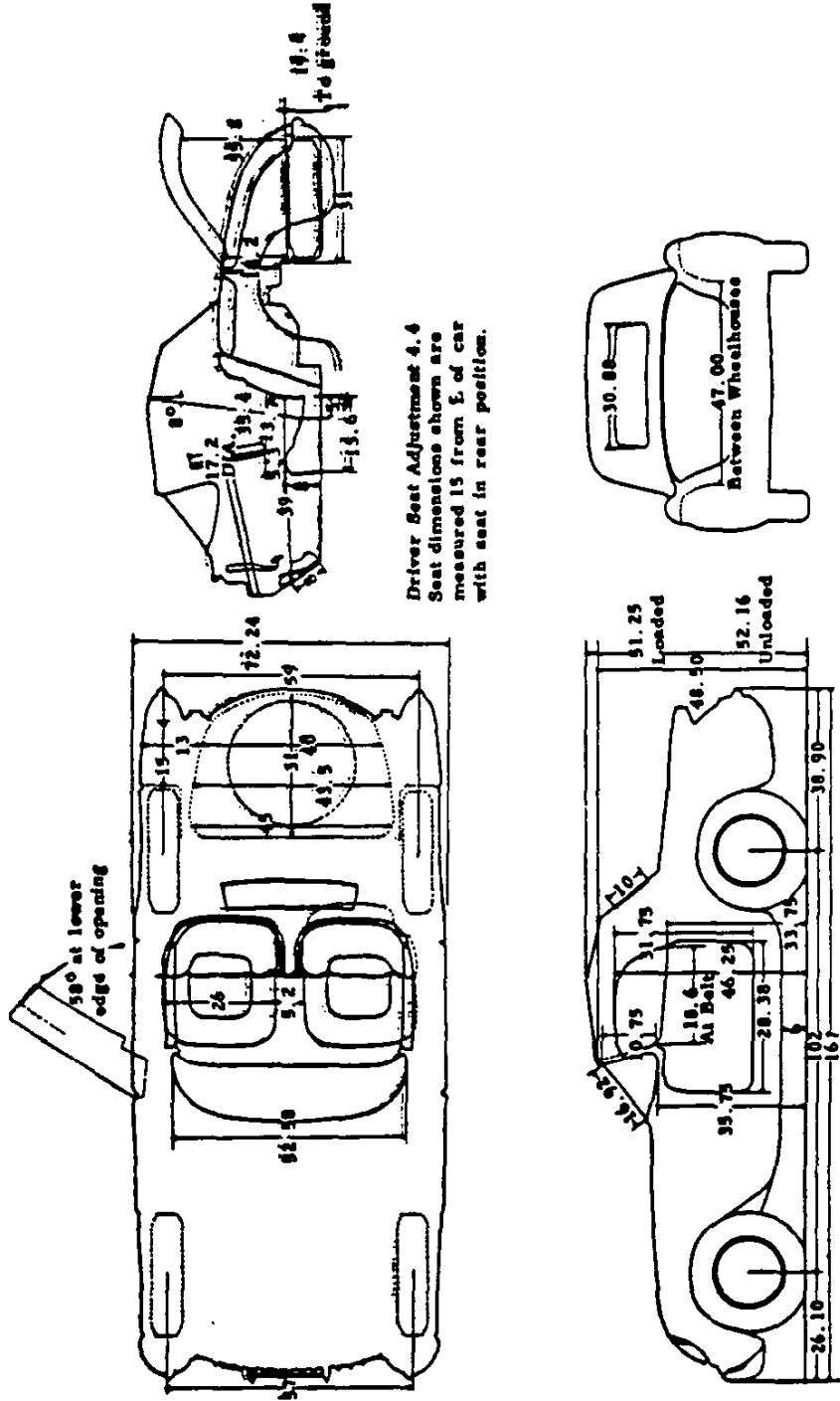

Driver Seat Adjustment 4.4
 Seat dimensions shown are measured 15 from E. of car with seat in rear position.

CORVETTE - SUPPLEMENT •

SERIAL NUMBERS

Vehicle Serial Number:
 Type designation ---- "VE" for 8-Cyl; "V" for 6-Cyl
 Assembly plant ----- "S" for St. Louis;
 thus "VE" or "V" 55S 001001 is the first unit.
 Transmission Serial Number:
 Type designation and Assembly plant-"C" for Cleveland
 Engine Serial Number: Type designation -----
 6-Cylinder Powerglide ----- YG
 8-Cylinder Powerglide ----- FG
 Rear Axle Serial Number:
 Type designation -----
 "AE"; unit is built at Detroit Gear and Axle plant.

DIMENSIONS

Wheelbase ----- 102
 Length (Overall) ----- 167
 Width (Overall) ----- 72.24
 Height (Over windshield with top down) ----- 48.50
 Tread: Front ----- 56.70
 Rear ----- 58.80

VEHICLE WEIGHTS*

6-Cylinder with Powerglide:
 Shipping -----2695 pounds
 Curb ----- 2840 pounds
 Loaded ----- 3140 pounds
 8-Cylinder with Powerglide:
 Shipping ----- 2665 pounds
 Curb ----- 2805 pounds
 Loaded ----- 3105 pounds
 * - Curb weight: This is the weight of the empty vehicle ready to drive. It is the shipping weight plus the weight of gasoline (105 pounds) and water (6-Cylinder - 38 pounds; 8-Cylinder - 35 pounds). For definition of Shipping and Loaded Weights see page 10.

FRAME

Make and Type ---- Own, Box Girder with "X" member
 Maximum overall length ----- 139.28
 Maximum overall width (over side members) --- 43.24
 Material ----- Hot Rolled Steel
 Material yield point ----- 33,000 lbs/sq. in.
 Material elongation ----- 25% minimum in 2 inches
 Side member section modulus (inches cubed) ---- 1.677
 Moment of inertia (in. ⁴) ----- 4.930
 Construction:
 Side members ----- Box section, each composed of two full length channel sections welded together.
 Front suspension cross member-Flanged, semi-tubular section with welded-on flat steel bottom plate.
 Rear shock absorber upper mounting cross member----- Inverted channel section
 Rear cross member - Box section composed of a flanged channel section and a welded-on bottom plate.
 Center "X" member -----
 Composed of I-beam sections attached to side members at the end of each leg of the "X". Also attached to forward section of side members by long angular braces from the front legs of the "X".

EQUIPMENT

Arm Rest ----- Both Doors
 Stowage Compartment ----- Both Doors
 Top -----
 ----- Folding, manually operated and stowed in top well at rear of driver and passenger seats.
 Door Windows ----- In chrome frames including ventipanes. Window frame snaps into slots in top of doors. When not in use the side windows are stored in the luggage compartment.
 Luggage Compartment -----
 ----- Rear Deck; operated by key with counterbalanced lid. Spare tire stowed below floor.
 Hood ----- Hinged at front with release inside of cockpit. Supported in open position by manually operated support arm.
 Headlights -----
 ----- Recessed into front fenders behind mesh grille.

EXTERIOR-INTERIOR COLORS

EXTERIOR	TOP COLOR	WHEELS	INTERIOR
Polo White	White	Red	Red
Harvest Gold	Dark Green	Yellow	Yellow
Gypsy Red	Beige	Red	Light Beige
Corvette Copper	White	Bronze	Dark Beige

INTERIOR COLORS

ITEM	Red	Yellow	Light Beige	Dark Beige
Upper Inst. Panel	Red	Green	Red	Bronze
Steering Column				
Steering Whl Hub & Spokes	Red	Green	Beige	White
Dir. Sig. Housing				
Lower Inst. Panel	White	Yellow	Beige	White
Door Trim Molding				
Steering Wheel Rim	White	Yellow	Red	Bronze
Seats				
Door Panels	Red	Yellow	Light Beige	Dark Beige
Cowl Side Kick Panels				

10-29-54. Revised: 6-10-55, • - Data revised.
 58 - CORVETTE CONVERTIBLE (MODEL 2934)

CORVETTE SUPPLEMENT - Continued •

FRONT SPRINGS

Make and Type -----Own, Coil
 Material and Gauge ---- Chrome alloy steel; .547-.553
 Number of Coils ----- Total, 9.75; Active, 7.94
 Diameters ----- Outside 4.30; Pitch 3.752
 Height ----- Free 13.45; Working 9.62 @ 1145 lbs
 Height under curb weight -----9.72
 Capacity at ground -----800 lbs
 Deflection Rate:
 At Spring -----300 lbs/in.
 At Wheel -----110 lbs/in.

FRONT SHOCK ABSORBERS

Make and Type -----Delco, Direct double-acting
 Mounting -----Vertically from lower control arm
 through coil spring to front suspension crossmember
 Model Number -----538F
 Valve Code -----3.5G6/OXR/P1.25
 Piston Diameter and Travel -----1 x 4.69

REAR SHOCK ABSORBERS

Make and Type -----Delco, Direct double-acting
 Mounting -----Stem attached at top to slotted holes
 in flanged "U" shaped rear crossmember, eye at-
 tached at bottom to an anchor bolt on rear spring
 "U" bolt and shock absorber anchor bolt plate.
 Model Number -----560P
 Valve Code -----4D6/OXH/J1.25
 Piston diameter and travel -----1 x 6.69

6-CYLINDER ENGINE (POWERGLIDE)

The Corvette engine is basically the same as the New Blue Flame-136 passenger car engine, with the following exceptions and characteristics:

Tappets -----Mechanical
 Timing Gear -----Aluminum
 Carburetor -----3-Side draft with manual choke
 Compression Ratio -----8.0:1
 Electrical System -----6-volt
 Piston Rings -----Top compression ring chrome plated
 Valve Springs -----Dual; Inlet and Exhaust

ADVERTISED MAXIMUM ENGINE PERFORMANCE

Gross Horsepower -----155 @ 4200 RPM
 Net Horsepower -----140 @ 4000 RPM
 Gross Torque -----225 @ 2800 RPM
 Net Torque -----212 @ 2800 RPM

ADVERTISED CAR PERFORMANCE

Based on curb weight plus 300 lbs for 2 passengers
 Performance weight -----3140 pounds
 Pounds/gross horsepower -----20
 Pounds/cu. in. displacement -----13.33
 Gross Horsepower/cu. in. displacement -----.66
 Power displacement (cu. ft./mile) -----182.4
 Displacement factor (cu. ft./ton mile) -----116.18

CARBURETOR

Number used -----3
 Make and Type -----Carter, Side Draft
 Size (Main Venturi Throat I.D.) -----1.312
 Choke -----Manual
 10-29-54. Revised: 6-10-55, e-Data revised.
CHEVROLET 1955 SPECIFICATIONS - PASSENGER

REAR SPRINGS

Make and Type -----Own, Semi-elliptic
 Material -----Chrome carbon steel
 Length and Width -----51 x 2
 Spring Clips -----Total-4; 3 clinch type, 1 bolt type
 Number of leaves -----4
 Thickness of leaves -----1 & 3, .282; 2, .313; 4, .262
 Total thickness -----1.159
 Camber height at design load -----1.58 Negative
 Average rate of deflection -----115 lbs/in.
 Capacity at spring pad -----575 lbs
 Capacity at ground -----725 lbs

DRIVE LINE

Type -----Hotchkiss drive
 with one propeller shaft with "U" Joints at both ends

REAR AXLE

Same as Passenger Powerglide, See page 31
SERVICE AND PARKING BRAKES

STEERING

Steering Gear Ratio -----16:1
 Steering Wheel Diameter -----17.25
 Turning Diameters:
 Right - Wall to Wall -----38.58
 Left - Wall to Wall -----38.99
 Right - Curb to Curb -----36.55
 Left - Curb to Curb -----36.93

CAMSHAFT

Ramp, Inlet:
 Opening -----.01070, 30° Long
 Closing -----.00856, 18° Long
 Ramp, Exhaust:
 Opening -----.01481, 37° Long
 Closing -----.01476, 30° Long
 Tappet Lift:
 Inlet -----.27428
 Exhaust -----.28049
 Valve Lift:
 Inlet -----.4051
 Exhaust -----.4143

AIR INLET

Number Used -----Three (One for each carburetor)
 Type -----Chrome plated metal housing with screen covered openings

ELECTRICAL SYSTEM (6-Volt)†

Generator -----Delco-Remy, 1102793
 Voltage & Current Regulator --- Delco-Remy, 1118827
 Distributor -----1112314
 Coil -----1115394
 Spark Plugs -----AC 43-5
 Commercial Spark Plugs, Wires, Distributor and
 Coil are completely enclosed by a metal shield.
 Firing Order -----1-5-3-6-2-4
 Valve Timing (Theoretical)
 Intake Opens -----19° 30' BTC
 Intake Closes -----44° 30' ABC
 Exhaust Opens -----59° BBC
 Exhaust Closes -----50° ATC
 Battery -----Delco,
 6-volt, 15 plate; 100 amp/hrs. @ 20 hour rating
 † - See page 60 for definition.

CORVETTE - SUPPLEMENT

ENGINE PERFORMANCE

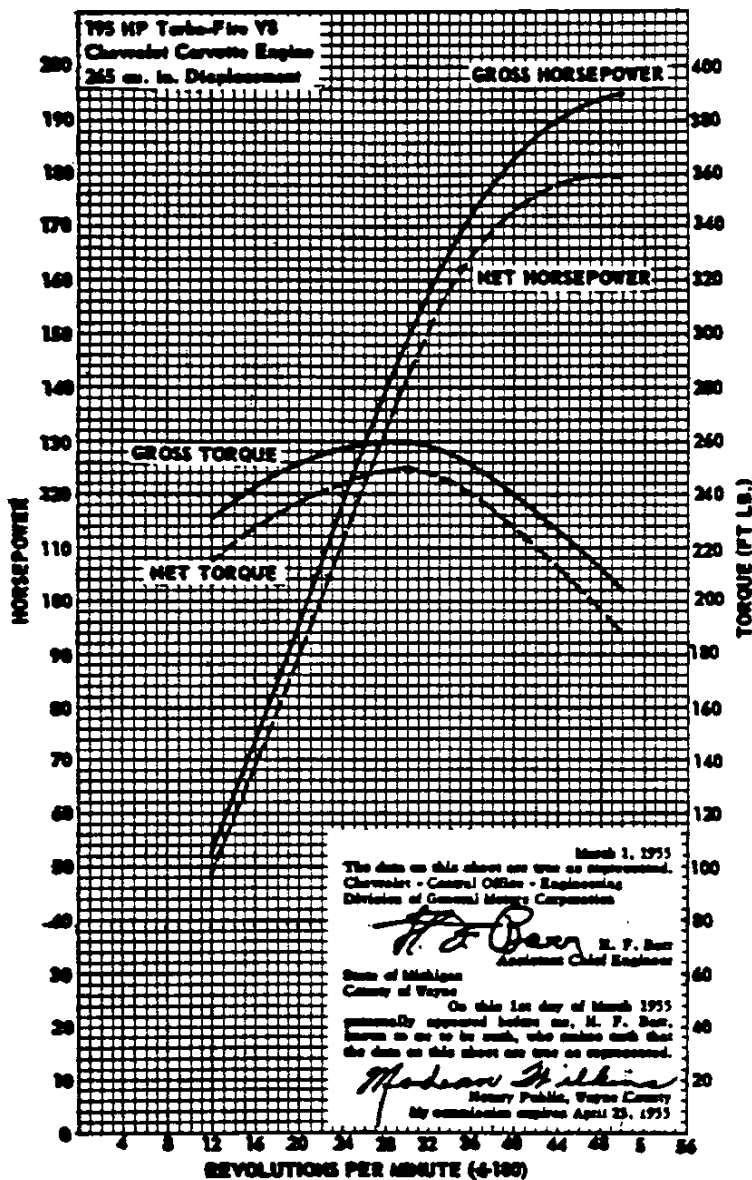

The engine performance curves shown on this sheet are taken from Chevrolet engine test report 16965-89. They represent the full throttle performance of a Turbo-Fire V-8 Chevrolet corvette engine (265 cu. in. displacement) as obtained from dynamometer test data which were corrected to the standard barometric pressure 29.92" Hg. and the standard temperature of 60°F.

ular dynamometer test with the dynamometer exhaust system, no fan, generator not charging, and optimum spark advance.

NET POWER and TORQUE were obtained from a dynamometer test simulating actual operating conditions when the engine is in its vehicle. It includes the use of the regular mufflers and pipes, the fan in operation and automatic spark advance. The generator is not charging.

GROSS POWER and TORQUE were obtained in a regular dynamometer test with the dynamometer exhaust system, no fan, generator not charging, and optimum spark advance.

6-10-55.
408 - CORVETTE CONVERTIBLE (MODEL 2934)

CHEVROLET 1955 SPECIFICATIONS - PASSENGER

IDENTIFICATION CODES

THIS LIST OF ENGINE, PAINT, AND SERIES CODES WILL HELP TO IDENTIFY YOUR '55-'57 AS CHEVROLET ORIGINALLY BUILT IT

As a special service for our readers, here is a handy guide to exterior paint combinations, engine identification and series identification for '55, '56, and '57 Chevys. The paint combination numbers correspond with the paint number stamped on the fire-wall tag. The original Duco numbers refer to acrylic lacquer, while the Dulux is acrylic enamel. With this

information, you can identify the original paint scheme on your '55-'57, particularly if it's one of the multitude of two-tone combinations offered during those three years. The engine I.d. codes indicate the original engine and transmission combination. Plus, the casting numbers will help tell whether or not the engine is original. This can be extremely helpful, especially if

you're buying a car the seller claims is original.

Finally, the series I.d. indicates what model the car is. Since it's relatively easy to transform a 150 into a Bel Air with the right exterior trim and upholstery upgrades, this is helpful information in determining a car's origins. All info is courtesy of Danchuk Manufacturing and is compiled from various Chevy sources. ●

No.	Model	Uses
585	1011-11A-19	
585	1011D-190-3	
586	1011-11A-19	
586	1011D-190-6	
587	1011-11A-19	1200 Series
587	1011-190-37	
588	1011-11A-19	
588	1011D-190-6	
589	1011-11A-19	11B-19-71
589	1011-190-37	
590	1011-19-121	
590	1011D-190	
591	1011-19-62F	11B-19
591	Bel Air	
592	1011-19-62F	19-63F
592	1067D	
593	1011-11A-19	
593	1011D-190	
594	1011-19-121	
594	1011D-190	
596	Convertible	
596	1062DF-67D	
626	Convertible	
630	Sport Coupe	
683	1011-11A-16	
683	1011D-190	

ENGINE IDENTIFICATION

Source Designation: F—Flint, T—Tonawanda

Model Year Designation: '55

(Model Year Designation for 8-Cylinder, 3-Speed Corvette is 255)

Example of engine identification: The 65th 2400 Series six-cylinder engine built at Flint to be used with Powerglide would be stamped 0001065F55Y. If built at Tonawanda, it would have serial No. 0001065T55Y

Model	Engine Type	Serial No. Suffix
15-21-2400	"235" 8-Cylinder—3-Speed and Overdrive	Z
Taxi-Cab	"235" 8-Cylinder—H.D. Clutch	ZC
15-21-2400	"235" 8-Cylinder—3-Speed—Aluminum Camshaft Gear	ZH
15-21-2400	"235" 8-Cylinder—H.D. Clutch Aluminum Camshaft Gear	ZJ
15-21-2400	"235" 8-Cylinder—Powerglide	Y
15-21-2400	"265" 8-Cylinder—3-Speed	G
15-21-2400	"265" 8-Cylinder—Overdrive	GC
15-21-2400	"265" 8-Cylinder—3-Speed Air Conditioning	GF
15-21-2400	"265" 8-Cylinder—Overdrive—Air Conditioning	GO
15-21-2400	"265" 8-Cylinder—H.D. Clutch	GJ
15-21-2400	"265" 8-Cylinder—H.D. Clutch Air Conditioning	GK
15-21-2400	"265" 8-Cylinder—3-Speed Dual Exhaust—4-bbl.	GL
15-21-2400	"265" 8-Cylinder—3-Speed Dual Exhaust—4-bbl.—Air Conditioning	GM
15-21-2400	"265" 8-Cylinder—Overdrive Dual Exhaust—4-bbl.	GE
15-21-2400	"265" 8-Cylinder—Overdrive Dual Exhaust—4-bbl.—Air Conditioning	GN
15-21-2400	"265" 8-Cylinder—Powerglide	F
15-21-2400	"265" 8-Cylinder—Dual Exhaust—4-bbl.	FB
15-21-2400	"265" 8-Cylinder—Powerglide—Air Conditioning	FC
15-21-2400	"265" 8-Cylinder—Powerglide—Dual Exhaust—4-bbl.—Air Conditioning	FD
2900	"235" 8-Cylinder—Powerglide	YG
2900	"265" 8-Cylinder—Powerglide	FG
2900	"265" 8-Cylinder—3-Speed	GR

1955

Model	Engine Type
15-21-2400	"265" 8-Cylinder—Powerglide
15-21-2400	"265" 8-Cylinder—Powerglide—4-bbl.
15-21-2400	"265" 8-Cylinder—Powerglide—4-bbl.
15-21-2400	"265" 8-Cylinder—Air Conditioning
15-21-2400	"265" 8-Cylinder—Air Conditioning—4-bbl.
15-21-2400	"265" 8-Cylinder—3-Speed
2900	"265" 8-Cylinder—Dual 4-bbl. w/H-Lift Camshaft
2900	"265" 8-Cylinder—Dual 4-bbl.
2900	"265" 8-Cylinder—Powerglide
2900	"265" 8-Cylinder—Powerglide Dual 4-bbl.

Source Designation: F—Flint, T—Tonawanda

C—Canada

Starting Unit Number: The three- or four-digit number following the source designation marks the month and date produced. The last two digits designate the date, i.e. (01) for the first day of the month, (10) for the tenth day, etc. The digits preceding the date produced designate the month, i.e. (1) for January, (11) for November.

Example of engine identification: A standard 2400 series type engine built at Flint on March 1st would be stamped F301A. If built at Tonawanda on October 19, it would have serial No. T1019A.

1956

Source Designation: F—Flint, T—Tonawanda

Model Year Designation: '56

Example of engine identification: The 50th 2100 Series eight-cylinder engine for overdrive transmission built at Flint would be stamped 0001050F56GC. If built at Tonawanda, it would have serial No. 0001050T56GC.

NOTE: After October 1, 1956, past model series engines will show the latest year of application immediately preceding the source letter.

Model	Engine Type	Serial No. Suffix
15-21-2400	"235" 8-Cylinder—3-Speed and Overdrive	Z
15-21-2400	"235" 8-Cylinder—H.D. Clutch	ZC
15-21-2400	"235" 8-Cylinder—Powerglide	Y
15-21-2400	"265" 8-Cylinder—3-Speed	G
15-21-2400	"265" 8-Cylinder—Overdrive	GC
15-21-2400	"265" 8-Cylinder—4-bbl.	GL
15-21-2400	"265" 8-Cylinder—Dual 4-bbl. w/H-Lift Camshaft	GS
15-21-2400	"265" 8-Cylinder—Dual 4-bbl.—Air Conditioning	GT
15-21-2400	"265" 8-Cylinder—H.D. Clutch	GM
15-21-2400	"265" 8-Cylinder—H.D. Clutch—Air Conditioning	GJ
15-21-2400	"265" 8-Cylinder—H.D. Clutch—Air Conditioning	GK
15-21-2400	"265" 8-Cylinder—Overdrive—4-bbl.	GE
15-21-2400	"265" 8-Cylinder—Overdrive—Air Conditioning—4-bbl.	GN

Model	Engine Type
15-21-2400	"235" 8-Cylinder—3-Speed and Overdrive
15-21-2400	"235" 8-Cylinder—H.D. Clutch
15-21-2400	"235" 8-Cylinder—Powerglide
15-21-2400	"265" 8-Cylinder—3-Speed
15-21-2400	"265" 8-Cylinder—Overdrive
15-21-2400	"265" 8-Cylinder—3-Speed
15-21-2400	"263" 8-Cylinder—4-bbl.
15-21-2400	"263" 8-Cylinder—Dual 4-bbl. w/H-Lift Camshaft
15-21-2400	"263" 8-Cylinder—Fuel-Injection
15-21-2400	"263" 8-Cylinder—Fuel-Injection w/H-Lift Camshaft
15-21-2400	"263" 8-Cylinder—Overdrive—4-bbl.
15-21-2400	"263" 8-Cylinder—Powerglide
15-21-2400	"263" 8-Cylinder—Powerglide—Air Conditioning
15-21-2400	"263" 8-Cylinder—Powerglide—4-bbl.
15-21-2400	"263" 8-Cylinder—Powerglide—Dual 4-bbl.
15-21-2400	"263" 8-Cylinder—Powerglide—Fuel-Injection
15-21-2400	"263" 8-Cylinder—Powerglide—4-bbl.—Air Conditioning
15-21-2400	"263" 8-Cylinder—Turboglide
15-21-2400	"263" 8-Cylinder—Turboglide—4-bbl.
15-21-2400	"263" 8-Cylinder—Turboglide—Dual 4-bbl.
15-21-2400	"263" 8-Cylinder—Turboglide—Fuel-Injection
15-21-2400	"263" 8-Cylinder—3-Speed—4-bbl.
15-21-2400	"263" 8-Cylinder—Dual 4-bbl. w/H-Lift Camshaft
15-21-2400	"263" 8-Cylinder—Dual 4-bbl.
15-21-2400	"263" 8-Cylinder—Fuel-Injection w/H-Lift Camshaft—Air Conditioning
15-21-2400	"263" 8-Cylinder—Fuel-Injection with H-Lift Camshaft
15-21-2400	"263" 8-Cylinder—Fuel-Injection
15-21-2400	"263" 8-Cylinder—Powerglide—Dual 4-bbl.
15-21-2400	"263" 8-Cylinder—Powerglide
15-21-2400	"263" 8-Cylinder—Powerglide—Fuel-Injection

1956

Serial # Suffix

No. Model Usage Style No.

599	1011-19-62F	
	1211-19-63F	
599	1011D-190	
600	1011-19-	1211-19
600	1011D-190	
601	Sport Coupe	
602	1011-11A-16	1211-1219
602	1011D-190-37D	
603	1062F-63F	
604	1062DF-67C	
605	1011-11A-15	
606	1011-19-	1263F
606	1011D-190-37D-62DF	
607	1011-11A-16	
608	1011A	
608	1011D-190-37D-67D	
610	1062F-63F	
610	Convertible	
612	1011D-190-37D-67D	
613	1011-19-121	11B-19
613	1011D-190-37D	
614	1011-11A-19-62F-63F	
614	1011D-190-37D-62DF	
615	1037D-62DF	67D
617	1011A	
624	1011-19-121	11B-19
624	1011D-190	
627	1011D-190-37D-64DF-67D	
628	1011A	
628	1011D-190-37D	
629	Convertible	

'55 PAINT COMBINATION CHART

No.	Model Usage Style No.	Body Color	Dress No.	Wheel Color	Dulux No.	Wheel Striping	Dress
585	1011-11A-19-1211-11B-19-71	Onyx Black	2532247	Onyx Black	505	Argent Silver	2894202
585	1011D-19D-37D-67D	Onyx Black	2532247	Onyx Black	505	None	
586	1011-11A-19-1200 Series	See Mist Gr.	25357950	See Mist Gr.	670	Onyx Black	2532247
586	1011D-19D-67D	See Mist Gr.	25357950	See Mist Gr.	None		
587	1011-11A-19-62F-63F-1211-1200 Series	Neptune Gr.	28157951	Neptune Gr.	671	Argent Silver	2894202
587	1011-19D-37D-62DF	Neptune Gr.	28157951	Neptune Gr.	671	None	
588	1011-11A-19-1211-11B-19-71	Skyline Blue	25358001	Skyline Blue	680	Onyx Black	2532247
588	1011D-19D-67D	Skyline Blue	25358001	Skyline Blue	680	None	
589	1011-11A-19-62F-63F-1211-11B-19-71	Glacier Blue	28157921	Glacier Blue	678	Argent Silver	2894202
589	1011-19D-37D-62DF	Glacier Blue	28157921	Glacier Blue	678	None	
590	1011-19-1211-11B-19-71	Copper Mar.	28158099	Copper Mar.	678	Argent Silver	2894202
590	1011D-19D	Copper Mar.	28158099	Copper Mar.	678	None	
591	1011-19-62F-63F-1211-11B-19	Shoreline	25357802	Shoreline	647	Onyx Black	2532247
591	Bel Air	Beige	25357802	Beige	647	None	
592	1011-19-62F-63F-1211-11B-19-63F	Shoreline	25357802	Shoreline	647	None	
592	1067D	Beige	25357802	Beige	647	None	
592	1067D	Autumn Bronze	28158009	Autumn Bronze	672	Argent Silver	2894202
592	1067D	Autumn Bronze	28158009	Autumn Bronze	672	None	
593	1011-11A-19-1211-11B-19-71	India Ivory	25358458	India Ivory	689	Onyx Black	2532247
593	1011D-19D	India Ivory	25358458	India Ivory	689	None	
594	1011-19-1211-11B-19-71	Shadow	28657831	Shadow	654	Argent Silver	2894202
594	1011D-19D	Gray Shadow	28657831	Gray Shadow	654	None	
594	1011D-19D	Gray Shadow	28657831	Gray Shadow	654	None	
596	Convertible	Gypsy Red	25357953	Gypsy Red	673	None	
596	1062DF-67D	Regal Turq.	28157955	Regal Turq.	675	None	
628	Convertible	Coral	25357990	Coral	679	None	
630	Sport Coupe	Harvest Gold	25358456	Harvest Gold	696	None	
683	1011-11A-19-1211-11B-19-71	Cashmere Blue	25358455	Cashmere Blue	699	Onyx Black	2532247
683	1011D-19D	Cashmere Blue	25358455	Cashmere Blue	699	None	

'55 TWO-TONE COLOR COMB

No.	Model Usage Style No.	Upper Body Color	Dress No.	Lower Body Color	Dress No.	W C
631	1011A	India Ivory	25358458	Harvest Gold	25358458	H G H C B
631	1011D-19D-37D-67D	India Ivory	25358458	Harvest Gold	25358458	H G H C B
682	1011-11A-19-62F-63F-1211-19	India Ivory	25358458	Cashmere Blue	25358455	C B
682	1011D-19D-37D-62DF-64DF-67D	India Ivory	25358458	Cashmere Blue	25358455	C B
684	1011-19-62F-63F-1263F	India Ivory	25358458	Navajo Tan	28158457	N T N T
684	1011D-19D-37D-62DF-64DF-67D	India Ivory	25358458	Navajo Tan	28158457	N T N T
685	1011D-19D-37D-64DF-67D	India Ivory	25358458	Dusk Rose	28658459	C

'55 PAINT COMBINATION

No.	Model Usage Style No.	Body Color	Dress No.	Wheel Color
687	All Models	Onyx Black	2532247	Onyx Black
688	150, 210 Series	Pinecrest Green	25358897	Pinecrest Green
688	1011D-19D-37D-39D-62DF-67D	Pinecrest Green	25358897	Pinecrest Green
690	150, 210 Series	Sherwood Green	28659525	Sherwood Green
690	1011D-19D-37D-39D-67D	Sherwood Green	28659525	Sherwood Green
691	150, 210 Series	Nassau Blue	25358752	Nassau Blue
691	1011D-19D-37D-39D-62DF-67D	Nassau Blue	25358752	Nassau Blue
692	1011-19-37-39-1271	Harbor Blue	28158812	Harbor Blue
692	1011D-19D-37D-39D-67D	Harbor Blue	28158812	Harbor Blue
693	1011-11A-19-37-39	Dusk Plum	28159238	Dusk Plum
693	1011D-19D-37D-39D-62DF-67D	Dusk Plum	28159238	Dusk Plum
694	150, 210 Series	India Ivory	25358458	India Ivory
694	1011D-19D-37D-39D-62DF-67D	India Ivory	25358458	India Ivory
695	150 (exc. 1271), 210 Series	Crocus Yellow	25358783	Crocus Yellow
695	1011D-19D-37D-39D-62DF-67D	Crocus Yellow	25358783	Crocus Yellow
697	150 (exc. 1263F), 210 Series	Matador Red	25359446	Matador Red
697	1011D-19D-37D-39D-62DF-67D	Matador Red	25359446	Matador Red
698	210 Series-1211-11B-19	Twilight Turquoise	25358920	Twilight Turquoise
698	1011D-19D-37D-39D-62DF-67D	Twilight Turquoise	25358920	Twilight Turquoise
749	150 (exc. 1271-63F), 210 Series	Tropical Turquoise	25358787	Tropical Turquoise
749	Bel Air (exc. 1084DF)	Tropical Turquoise	25358787	Tropical Turquoise
750	150 Series (exc. 1271)	Calypeo Cream	25390209	Calypeo Cream
752	210 Series	Inca Silver	88758303	Inca Silver
752	Bel Air Series	Inca Silver	88758303	Inca Silver

Because of various color separations on the 1956 models, t indicator to the color combinations and their respec

'55 TWO-TONE COLOR COMB

No.	Model Usage Style No.	Upper Body Color	Dress No.	Lower Body Color	Dress No.
696	150, 210 Series	Crocus Yellow	25358783	Onyx Black	2532247
696	Bel Air Series	Crocus Yellow	25358783	Onyx Black	2532247
700	Bel Air Series	Sierra Gold	28659894	Adobe Beige	25359895
701	150, 210 Series	India Ivory	25358458	Onyx Black	2532247
701	Bel Air Series	India Ivory	25358458	Onyx Black	2532247
702	150, 210 Series	Sherwood Green	28659525	Pinecrest Green	25358897
702	Bel Air Series	Sherwood Green	28659525	Pinecrest Green	25358897
703	1011-19-37-39	Harbor Blue	28158812	Nassau Blue	25358752

'55 TWO-TONE COLOR COMBINATIONS

No.	Model Usage Style No.	Upper Body Color	Dress No.	Lower Body Color	Dress No.	Wheel Color	Dulux No.	Wheel Striping	Dress No.
599	1011-19-62F-1211-19-63F	See Mist Gr.	25357950	Neptune Gr.	28157951	Neptune Gr.	671	Argent Silver	2894202
599	1011D-19D	See Mist Gr.	25357950	Neptune Gr.	28157951	Neptune Gr.	671	None	
600	1011-19-1211-19	Skyline Blue	25358001	Glacier Blue	28157921	Glacier Blue	678	Argent Silver	2894202
600	1011D-19D	Skyline Blue	25358001	Glacier Blue	28157921	Glacier Blue	678	None	
601	1011D-19D	Skyline Blue	25358001	Glacier Blue	28157921	Glacier Blue	678	None	
601	Sport Coupe	Neptune Gr.	28157951	Shoreline	25357802	Shoreline	647	None	
602	1011-11A-19-1211-1219	India Ivory	25358458	Beige	25358001	Skyline Blue	680	Onyx Black	2532247
602	1011D-19D-37D	India Ivory	25358458	Skyline Blue	25358001	Skyline Blue	680	None	
603	1062F-63F	Autumn Bronze	28158009	Shoreline	25357802	Shoreline	647	Onyx Black	2532247
604	1062DF-67D	Beige	25357802	Beige	25357802	Beige	647	None	
604	1062DF-67D	Neptune Gr.	28157951	See Mist Gr.	25357950	See Mist Gr.	670	None	
605	1011-11A-19	India Ivory	25358458	See Mist Gr.	25357950	See Mist Gr.	670	Onyx Black	2532247
606	1011-19-1263F	Shoreline	25357802	Autumn Bronze	28158009	Autumn Bronze	672	Argent Silver	2894202
606	1011D-19D-37D-62DF	Beige	25357802	Autumn Bronze	28158009	Autumn Bronze	672	None	
607	1011-11A-19	Glacier Blue	28157921	Shoreline	25357802	Shoreline	647	Onyx Black	2532247
608	1011A	India Ivory	25358458	Onyx Black	2532247	Onyx Black	505	Argent Silver	2894202
608	1011D-19D-37D-67D	India Ivory	25358458	Onyx Black	2532247	Onyx Black	505	None	
610	1062F-63F	Glacier Blue	28157921	Skyline Blue	25358001	Skyline Blue	680	Onyx Black	2532247
610	Convertible	Glacier Blue	28157921	Skyline Blue	25358001	Skyline Blue	680	None	
612	1011D-19D-37D-67D	India Ivory	25358458	Regal	28157955	Regal	675	None	
613	1011-19-1211-11B-19	Shoreline	25357802	Turquoise	25357802	Turquoise	671	Argent Silver	2894202
613	1011D-19D-37D	Shoreline	25357802	Neptune Gr.	28157951	Neptune Gr.	671	None	
614	1011-11A-19-62F-63F-1211-19	Shoreline	25357802	Glacier Blue	28157921	Glacier Blue	678	Argent Silver	2894202
614	1011D-19D-37D-62DF	Beige	25357802	Glacier Blue	28157921	Glacier Blue	678	None	
615	1037D-62DF-67D	Shoreline	25357802	Gypsy Red	25357953	Gypsy Red	673	None	
617	1011A	India Ivory	25358458	Gypsy Red	25357953	Gypsy Red	673	Argent Silver	2894202
624	1011-19-1211-11B-19	India Ivory	25358458	Shadow	28657831	Shadow	654	Argent Silver	2894202
624	1011D-19D	India Ivory	25358458	Gray Shadow	28657831	Gray Shadow	654	None	
627	1011D-19D-37D-64DF-67D	Shadow	28657831	Gray Shadow	28657831	Gray Shadow	654	None	
628	1011A	Onyx Black	2532247	Coral	25357990	Coral	679	None	
628	1011D-19D-37D	Onyx Black	2532247	India Ivory	25358458	India Ivory	689	Onyx Black	2532247
628	1011D-19D-37D	Onyx Black	2532247	India Ivory	25358458	India Ivory	689	None	
629	Convertible	India Ivory	25358458	Coral	25357990	Coral	689	None	

urns
3
rel-
nto
rim
g a
of
OM-
S.
55
FB
FH
FC
FD
GV
GU
GR
FK
FG
57
tion
11) for
e
on
s
Affix
A
AD
B
C
CD
CE
E
EB
EJ
EK
EC
F
FA
FC
FD
FJ
FE
G
GC
GD
GF
EG
EF
EH
EL
EN
FM
FG
FH
FR

'66 COLOR COMBINATIONS

Owner Body Color	Base No.	Wheel Color	Dust No.	Wheel Striping	Dust No.
Harvest Gold	25358456	Harvest Gold	698	Onyx Black	2532247
Harvest Gold	25358456	Harvest Gold	698	None	
Cashmere Blue	25358455	Cashmere Blue	699	Onyx Black	2532247
Cashmere Blue	25358455	Cashmere Blue	699	None	
Navajo Tan	28158457	Navajo Tan	700	Onyx Black	2532247
Navajo Tan	28158457	Navajo Tan	700	None	
Dusk Rose	28658459	Dusk Rose	690	None	

COMBINATION CHART

Base No.	Wheel Color	Dust No.	Wheel Striping	Dust No.
2532247	Onyx Black	505	Argent Silver	2894202
25358697	Pinecrest Green	716	Onyx Black	2532247
25358697	Pinecrest Green	716	None	
28659525	Shenwood Green	717	Argent Silver	2894202
28659525	Shenwood Green	717	None	
25358752	Nassau Blue	718	Onyx Black	2532247
25358752	Nassau Blue	718	None	
28158812	Harbor Blue	719	Argent Silver	2894202
28158812	Harbor Blue	719	None	
28159238	Dusk Plum	728	Argent Silver	2894202
28159238	Dusk Plum	728	None	
25358458	India Ivory	689	Onyx Black	2532247
25358458	India Ivory	689	None	
25358763	Crocus Yellow	725	Onyx Black	2532247
25358763	Crocus Yellow	725	None	
25359446	Matador Red	738	Onyx Black	2532247
25359446	Matador Red	738	None	
25358920	Twilight Turquoise	723	Argent Silver	2894202
25358920	Twilight Turquoise	723	None	
25359787	Tropical Turquoise	757	Argent Silver	2894202
25359787	Tropical Turquoise	757	None	
25390209	Calypso Cream	790	Onyx Black	2532247
38756303	Inca Silver	759	Onyx Black	2532247
38756303	Inca Silver	759	None	

For 1956 models, the following chart serves only as a guide and their respective identification numbers.

COLOR COMBINATIONS

Owner Body Color	Base No.	Wheel Color	Dust No.	Wheel Striping	Dust No.
Onyx Black	2532247	Crocus Yellow	725	Onyx Black	2532247
Onyx Black	2532247	Crocus Yellow	725	None	
Sierra Beige	25359695	Sierra Gold	742	None	
Onyx Black	2532247	Onyx Black	505	Argent Silver	2894202
Pinecrest Green	25358697	Onyx Black	505	None	
Pinecrest Green	25358697	Pinecrest Green	716	Onyx Black	2532247
Pinecrest Green	25358697	Pinecrest Green	716	None	
Nassau Blue	25358752	Harbor Blue	719	Argent Silver	2894202

'66 TWO-TONE COLOR COMBINATIONS

No.	Model Usage Style No.	Upper Body Color	Base No.	Lower Body Color	Base No.	Wheel Color	Dust No.	Wheel Striping	Dust No.
700	Bel Air Series (exc. 1082DF)	Harbor Blue	28158812	Nassau Blue	25358752	Harbor Blue	719	None	
705	150, 210 Series	India Ivory	25358458	Pinecrest Green	25358697	Pinecrest Green	716	Onyx Black	2532247
705	Bel Air Series	India Ivory	25358458	Pinecrest Green	25358697	Pinecrest Green	716	None	
706	150, 210 Series	India Ivory	25358458	Shenwood Green	28659525	Shenwood Green	717	Argent Silver	2894202
706	Bel Air Series (exc. 1082DF)	India Ivory	25358458	Shenwood Green	28659525	Shenwood Green	717	None	
707	150, 210 Series	India Ivory	25358458	Nassau Blue	25358752	Nassau Blue	718	Onyx Black	2532247
707	Bel Air Series	India Ivory	25358458	Nassau Blue	25358752	Nassau Blue	718	None	
708	210 Series	India Ivory	25358458	Dusk Plum	28159238	Dusk Plum	728	Argent Silver	2894202
708	Bel Air Series	India Ivory	25358458	Dusk Plum	28159238	Dusk Plum	728	None	
710	210 Series	India Ivory	25358458	Twilight Turquoise	25358920	Twilight Turquoise	723	Argent Silver	2894202
710	Bel Air Series	India Ivory	25358458	Twilight Turquoise	25358920	Twilight Turquoise	723	None	
711	150, 210 Series	India Ivory	25358458	Matador Red	25359446	Matador Red	738	Onyx Black	2532247
711	1011D-19D- 87D	India Ivory	25358458	Matador Red	25359446	Matador Red	738	None	
715	1037D-39D- 82DF-84DF	Matador Red	25359446	Dune Beige	25359144	Matador Red	738	None	
717	210 Series	Crocus Yellow	25358763	Laurel Green	28159423	Laurel Green	730	Argent Silver	2894202
717	Bel Air Series	Crocus Yellow	25358763	Laurel Green	28159423	Laurel Green	730	None	
721	210 Series (exc. 1011A)	India Ivory	25358458	Dawn Gray	28159692	Dawn Gray	755	Onyx Black	2532247
721	Bel Air Series	India Ivory	25358458	Dawn Gray	28159692	Dawn Gray	755	None	
754	210 Series	India Ivory	25358458	Tropical Turquoise	25359789	Tropical Turquoise	757	Argent Silver	2894202
754	Bel Air Series	India Ivory	25358458	Tropical Turquoise	25359789	Tropical Turquoise	757	None	
755	150 Series	Calypso Cream	25390209	Onyx Black	2532247	Calypso Cream	790	Onyx Black	2532247
756	150, 210 Series (exc. 1271)	Grecian Gold	28190317	Calypso Cream	25390209	Grecian Gold	794	Onyx Black	2532247
756	Bel Air Series	Grecian Gold	28190317	Calypso Cream	25390209	Calypso Cream	790	None	
757	210 Series	Inca Silver	88756303	Imperial Ivory	88559931	Imperial Ivory	799	Onyx Black	2532247
757	Bel Air Series	Inca Silver	88756303	Imperial Ivory	88559931	Inca Silver	759	None	
763	1039D- 1082DF- 1037D-	Matador Red	25359446	Adobe Beige	25359695	Matador Red	738	None	

'67 PAINT COMBINATION CHART

No.	Model Usage Style No.	Body Color	Base No.	Wheel Color	Dust No.
793	150, 210, Bel Air	Onyx Black	2532247	Onyx Black	505
794	150 (exc. 1529), 210, Bel Air (exc. 2409-29)	Imperial Ivory	88559931	Imperial Ivory	799
795	150, 210, Bel Air	Larkspur Blue	25390114	Larkspur Blue	808
796	150, 210, Bel Air	Harbor Blue	28158812	Harbor Blue	719
797	150, 210, Bel Air	Surf Green	25390147	Surf Green	807
798	150, 210, Bel Air	Highland Green	28659775	Highland Green	822
799	150 (exc. 1508), 210, Bel Air	Tropical Turquoise	25359787	Tropical Turquoise	757
800	150 (exc. 1508), 210, Bel Air	Colonial Cream	25358064	Colonial Cream	809
801	Bel Air Convertible	Canyon Coral	25390845	Canyon Coral	821
802	150, 210, Bel Air	Matador Red	25359446	Matador Red	738
803	Bel Air Convertible	Coronado	25390620	Coronado	818
804	210, Bel Air	Inca Silver	88756303	Inca Silver	759
806	2124-09-19-29, Bel Air	Sierra Gold	28659884	Sierra Gold	742
808	150 (exc. 1508), 210, Bel Air	Adobe Beige	25359695	Adobe Beige	780
821	Bel Air Convertible	Dusk Pearl	88790354	Dusk Pearl	812
823	Bel Air Convertible	Laurel Green	28190596	Laurel Green	808

Becc

No.	Model Usage Style
807	150 210 (exc. 150)
808	150 Bel (exc. 150)
809	150 Bel (exc. 150)
809	210
810	150 210 (exc. 150)
811	150 210 (exc. 150)
812	150 210
812	210
812	Bel (exc. 150)
813	150 210 (exc. 150)
814	210 (exc. 150)
815	150 Bel (exc. 150)
815	210
816	150 Bel (exc. 150)
816	210
817	210 (exc. 150)
818	2124 Bel (exc. 150)
819	150 Bel (exc. 150)
820	210 Bel (exc. 150)
820	Bel (exc. 150)
822	210
822	Bel (exc. 150)

Series
Pass.
Pass.
Pass.

Because of various color separations on the '57 models, the following chart serves only as an indicator to the color combinations and their respective identification numbers.

'57 TWO-TONE COLOR COMBINATIONS							
No.	Model Usage Style No.	Upper Body Color	Door No.	Lower Body Color	Door No.	Wheel Color	Detail No.
807	150 (exc. 150B), 210, Bel Air (exc. Conv.)	India Ivory	25358458	Onyx Black	2532247	Onyx Black	506
808	150 (exc. 150B), Bel Air (exc. Conv.)	Imperial Ivory	88559931	Inca Silver	86756303	Inca Silver	759
809	150 (exc. 150B), Bel Air (exc. Conv.)	—	—	Harbor Blue	28158812	Harbor Blue	719
809	210	Harbor Blue	28158812	Larkspur Blue	25390114	Larkspur Blue	808
810	150 (exc. 150B), 210, Bel Air (exc. Conv.)	India Ivory	25358458	Larkspur Blue	25390114	Larkspur Blue	808
811	150 (exc. 150B), 210 Bel Air (exc. Conv.)	India Ivory	25358458	Tropical Turquoise	25359787	Tropical Turquoise	757
812	150 (exc. Conv.)	—	—	Surf Green	25390147	Surf Green	807
812	210	Surf Green	25390147	Highland Green	28659775	Surf Green	807
812	Bel Air (exc. Conv.)	Surf Green	25390147	Highland Green	28659775	Highland Green	822
813	150 (exc. 150B), 210, Bel Air (exc. Conv.)	India Ivory	25358458	Surf Green	25390147	Surf Green	807
814	210, Bel Air (exc. Conv.)	India Ivory	25358458	Coronado Yellow	25390620	Coronado Yellow	819
815	150 (exc. 150B), Bel Air (exc. Conv.)	—	—	Colonial Cream	25358094	Colonial Cream	809
815	210	Colonial Cream	25358094	Onyx Black	2532247	Onyx Black	506
816	150 (exc. 150B), Bel Air (exc. Conv.)	—	—	Colonial Cream	25358094	Colonial Cream	809
816	210	Colonial Cream	25358094	India Ivory	25358458	Colonial Cream	809
817	210, Bel Air (exc. Conv.)	India Ivory	25358458	Canyon Coral	25390645	Canyon Coral	821
818	2124-09-19-29, Bel Air (exc. Conv.)	Adobe Beige	25359895	Sierra Gold	28659894	Sierra Gold	742
819	150 (exc. 150B), Bel Air (exc. Conv.)	India Ivory	25358458	Matador Red	25359448	Matador Red	738
820	210	Colonial Cream	25358094	Laurel Green	28190596	Colonial Cream	809
820	Bel Air (exc. conv.)	—	—	Laurel Green	28190596	Laurel Green	806
822	210	Dusk Pearl	88790354	Imperial Ivory	88559931	Dusk Pearl	812
822	Bel Air (exc. Conv.)	—	—	Dusk Pearl	88790354	Dusk Pearl	812

SERIES IDENTIFICATION '55-'57 MODEL/SERIES CHART

Series	Model	Body Style	Series	Model	Body Style
Series "A" Model "150"	1502	1211	Series "B" Model "210"	2102	1011
	1503	1219		2103	1019
	1512	1211B		2109	1082F
	1529	1263F		2113	1039
				2119	1082FC
		2124	1011A		
		2129	1083F		
		2154	1037		
Series "C" Model "Bel Air"	2402	1011D	Series "D" Model "150B"	1508	1271
	2403	1019D			
	2409	1082DF			
	2413	1039D			
	2419	1082DF			
	2429	1064DF			
	2434	1087D/or DTX			
	2454	1037D			

'55-'57 PASSENGER REAR AXLE IDENTIFICATION

Series Type	G & A Suffix	Series Type	G & A
Pass. 3-Speed	AA	Pass. 3-Speed w/post. (3.56 ratio)	AX
Pass. Automatic	AB	Pass. Overdrive w/post. (4.11 ratio)	AL
Pass. Overdrive	AC	Pass. Automatic w/post. (3.36 ratio)	AM

Axle identification is stamped on differential carrier along with the date of manufacture.

CASTING NUMBERS

Block	CAST NO.
'55-'57 6-Cyl. w/Dual Hole W. Pump	3835911
'55-'57 6-Cyl. w/Dual Hole W. Pump	3733949
'55-'57 6-Cyl. w/Dual Hole W. Pump	3833949
'55-'57 6-Cyl. w/Single Hole W. Pump	3739716
'55-'57 6-Cyl. w/Single Hole W. Pump	3838233
'55-'57 6-Cyl. w/Single Hole W. Pump	3837004
'55 V8	3703524
'55 V8	3720991
'55-'57 V8 265 and 283	3731548
'57 V8 w/Fuel-injection	3867802
Replacement casting No. 3731548 can be found on 285 or 283 '55-'57 blocks.	
CYLINDER HEADS	CAST NO.
'55-'57 6-Cyl.	3838548
'55 All V8 Engines	3703523
Sears 1955 2-bbl. Engines	3837064
'56 V8 2-bbl.	3837064
'56 V8 4-bbl.	3725306
'56 V8 2-4-bbl.	3731782
'57 V8 2-bbl.	3731554
'57 V8 4-bbl. 2-4-bbl. and F.I.	3731639
'57 V8 4-bbl. 2-4-bbl. and F.I.	3740997
INTAKE MANIFOLDS	CAST NO.
'55-'57 6-Cyl.	3835559
'55 V8 2-bbl.	3704790
'55 V8 4-bbl.	3711348
'56 V8 2-bbl.	3735444
'56 V8 4-bbl.	3735448
'56 V8 2-4-bbl.	3731394
'57 V8 2-bbl.	3732880
'57 V8 4-bbl. Early No. 3731396	3742829
'57 V8 2-4-bbl.	3739653
EXHAUST MANIFOLDS	CAST NO.
'55-'57 6-Cyl.	3835587
'55 V8 Right Side	3704792
'55 V8 Left Side	3704791
'56 V8 Right Side	3838988
'56 V8 Left Side	3837069
'56 V8 w/2-4-bbl. Right Side	3731558
'56 V8 w/2-4-bbl. Left Side	3731557
'57 V8 w/2-4-bbl. Right Side	3733978
'57 V8 Left Side	3733975
WATER PUMPS	CAST NO.
'55-'56 V8	3704911
'57 V8	3782508
'55-'57 2nd Design 6-Cyl.	3741033
BELLHOUSINGS	CAST NO.
'55-'57 Std. Trans. 6-Cyl.	3739585
'55-'57 Std. Trans. V8	3704922
'55-'56 V8 w/Powerglide	3838142
'57 V8 w/Powerglide	3733365
'55-'57 6-Cyl. w/Powerglide	3836601
HARMONIC BALANCERS	CAST NO.
'55-'57 All V8 Engines	8838196
'55-'57 All 6-Cyl. Engines	3836160
CARBURETORS	TAG NO.
'55-'57 6-Cyl. 1-bbl. Carter	2008
'55-'57 6-Cyl. 1-bbl. Carter	2048
'55-'57 6-Cyl. 1-bbl. Carter	2101
'55 6-Cyl. 1-bbl. Rochester	7007190
'55 6-Cyl. 1-bbl. Rochester	7007181
'56 6-Cyl. 1-bbl. Rochester	7009251
'56 6-Cyl. 1-bbl. Rochester	7009255
'57 6-Cyl. 1-bbl. Rochester	7009656
'57 6-Cyl. 1-bbl. Rochester	7009657
'55-'56 V-8 2-bbl. Carter (WGD)	2296
'55 V8 2-bbl. Rochester	7005810
'55 V8 2-bbl. Rochester	7006825
'55 V8 2-bbl. Rochester	7008004
'55 V8 2-bbl. Rochester	7008005
'56 V8 2-bbl. Rochester	7008387
'56 V8 2-bbl. Rochester	7008388
'57 V8 2-bbl. Rochester	7010847
'57 V8 2-bbl. Rochester	7010848
'57 V8 2-bbl. Rochester	7011224
'57 V8 2-bbl. Rochester	7011131
'55 V8 4-bbl. Carter (WCFB)	2218
'55 V8 4-bbl. Carter (WCFB)	2351
'56 V8 4-bbl. Carter (WCFB)	2386
'57 V8 4-bbl. Carter (WCFB)	2505
'57 V8 4-bbl. Carter (WCFB)	2565
'55-'57 V8 Dual 4-bbl. Carter, Front	2419
'55-'57 V8 Dual 4-bbl. Carter, Front	2613
'55-'57 V8 Dual 4-bbl. Carter, Front	2628
'55-'57 V8 Dual 4-bbl. Carter, Front	3181
'55-'57 V8 Dual 4-bbl. Carter, Front	3182
'55-'57 V8 Dual 4-bbl. Carter, Rear	2662
'55-'57 V8 Dual 4-bbl. Carter, Rear	2614
'55-'57 V8 Dual 4-bbl. Carter, Rear	2627
'56 V8 4-bbl. Rochester	7008737
'57 V8 4-bbl. Rochester	7009646
'57 V8 4-bbl. Rochester	7012128