

BLAZER

BLAZER MODEL SELECTOR

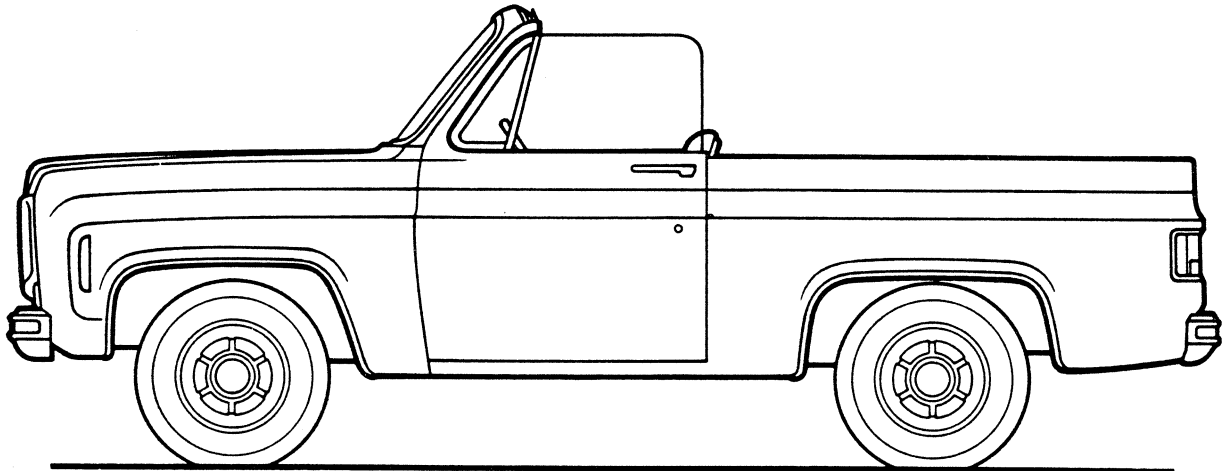

SERIES	MODEL NUMBER		BODY ORDERING CODE		
	Open Model (Without Top)	Closed Model (With Top)	Open Model	Closed Models	
				White Top	Black Top
C10	CC10514	CC10516	ZW9	Z58	Z59
K10 (4-Wheel Drive)	CK10514	CK10516	ZW9	Z58	Z59

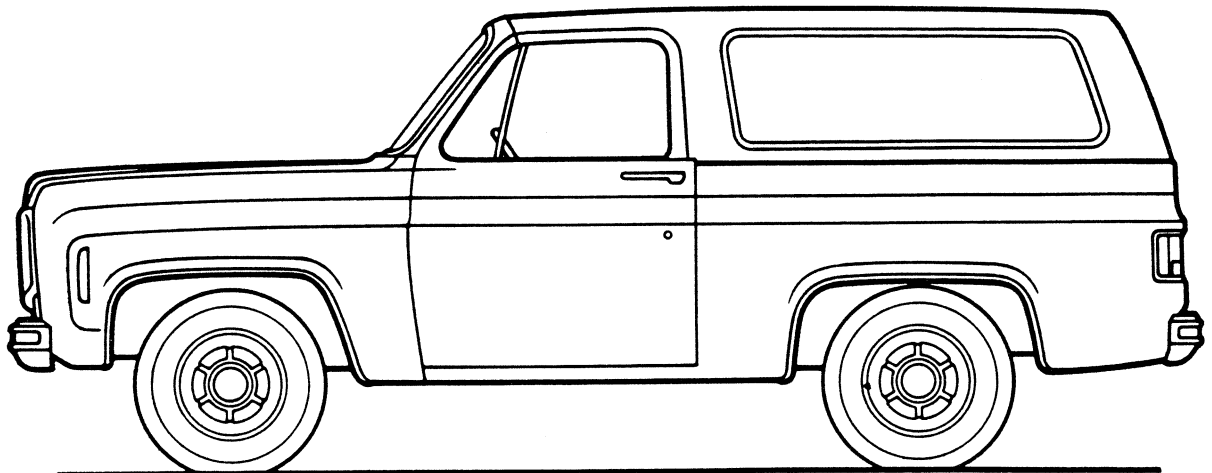

BLAZER

CUSTOM DELUXE FEATURES—STANDARD MODEL

The Custom Deluxe standard models include the following items as standard equipment

EXTERIOR

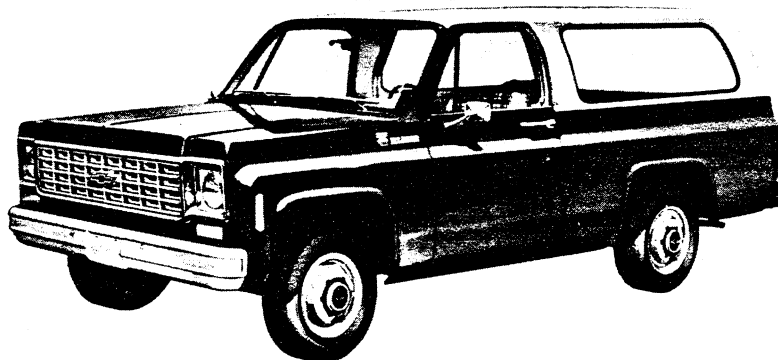

- **Bumpers:** Front and rear; painted white
- **Color:** See Interior and Exterior Color Selection Chart
- **Doors:** RH and LH side doors
- **Grille:** Molded plastic; painted silver; integral Chevrolet emblem at center includes bright insert with black and ochre trim
- **Grille Frame:** Bright upper and lower moldings joining extensions of bright headlamp bezels; silver-painted bezel centers
- **Horn:** Single, electric low-note
- **Hub Caps:** Painted white with black and ochre trim (2-wheel-drive models only)
- **Keys:** Two-key system with separate keys for ignition switch and doors (and tailgate on C-K10516 closed models)
- **Lettering, "CHEVROLET" Tailgate:** Painted white except black with Frost White body color (C-K10514 open models only)
- **Lights:**
 - Backup lamps: Two rear (integral with taillamps)
 - Combination parking/direction/hazard: Two front
 - Combination tail/stop/direction/hazard: Two rear
 - Headlamps: Two; Power Beam
 - License plate lamp: Single rear
 - Side marker lamps with reflectors: Two front (wraparound taillamps serve as rear side marker lamps)

- **Mirrors:** RH and LH fixed arm with 5½" x 4" head; chrome finish
- **Nameplates:** Bright "K5 Blazer" nameplates on upper portions of front fenders near doors; closed models (C-K10516) also have bright "Chevrolet" nameplate on tailgate
- **Removable Top:** (C-K10516 closed models only). Constructed of molded plastic reinforced with fiber glass. Included are LH and RH fixed side windows and a tailgate with a movable window. Operation of the tailgate window is through an articulated crank-type regulator handle on the tailgate outer panel; a key lock cylinder is concealed in the regulator handle, and must be unlocked before the window can be lowered. After the window is lowered, the tailgate is released with a handle located at the upper center of the inner panel. When open, the tailgate is supported by reel-type cables. The exterior of the top is finished with textured paint (black or white) and the interior is painted white
- **Tools:** Mechanical jack and wheel wrench
- **Wheels:** Painted white
- **Windshield Wipers and Washers:** Electric, 2-speed wipers with matte finish on exposed metal portions; partially concealed arms; coordinated dual-orifice washers

INTERIOR

- **Armrests:** RH and LH; integral with door trim panels
- **Ashtray:** In middle of instrument panel
- **Coat Hooks:** (C-K10516 closed models only) Two; on LH side
- **Colors:**
 - Paint: Same as main exterior color choice
 - Trim: Choice of blue, saddle, red, or green
- **Dome Lamps:** (C-K10516 closed models only) Two; with door-actuated switches (dome lamps may also be activated by main light switch)
- **Door Trim Panels:** Color-keyed, embossed molded plastic with integral armrests
- **Floor Mats:** Front compartment only; embossed black rubber
- **Heater and Defroster:** Deluxe-air; automatic blower operation with ignition switch on for power ventilation system
- **Instruments:**
 - Gauges: Speedometer, odometer, and fuel
 - Switches: Main, for control of exterior and interior lights; wiper-washer; headlamp beam (foot); ignition; direction signal (with lane change position); hazard warning; heater
 - Warning lights: Generator, oil pressure, engine temperature, brake, direction/hazard signal, and high beam
- **Instrument Panel Control Knobs:** Soft black plastic with white graphic identification (except heater and wiper-washer controls)
- **Instrument Panel Pad:** Color-keyed foam type with wood-grained applique having bright trim and bright "Custom Deluxe" nameplate
- **Insulation and Sound Deadening Material:** Dash (firewall) and under floor mat
- **Lights:** Instrument cluster lights and courtesy/map lights. Dome lights (C-K10516 closed models only)
- **Mirror, Rearview:** 10", vinyl-edged prismatic

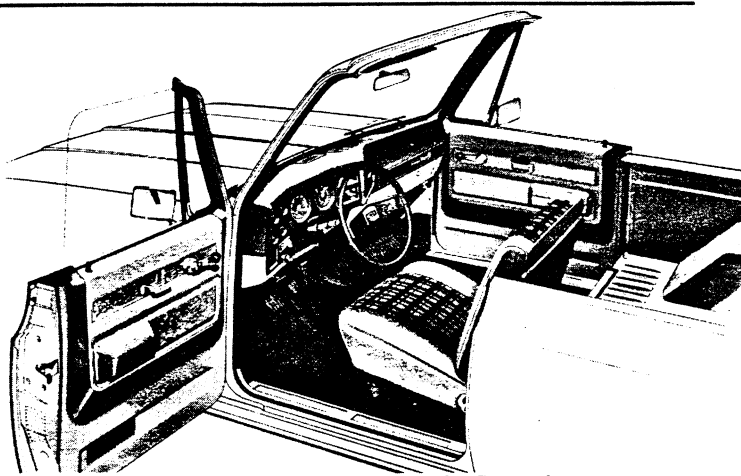

- **Roll Bar:** (C-K10516 closed models only) Painted same as main exterior color choice; incorporates black rubber pad at top; located behind driver seat and optional front passenger seat
- **Scuff Plates:** Door-opening protection and floor mat retainer
- **Seat:** Driver only; foam-padded bucket type with plaid pattern vinyl trim
- **Seat Belts:** Driver only. Includes retractor and pushbutton release
- **Spare Tire Mounting:** On RH side panel behind wheelhouse
- **Steering Wheel:** 17½" black wheel with 2-spoke design; black energy-absorbing steering column
- **Stowage Box:** In RH side of instrument panel; door with turn-type latch
- **Sunshade:** LH padded; color-keyed (RH also on C-K10516 closed models)

BLAZER

CHEYENNE MODEL OPTION—RPO Z84

This option includes all Custom Deluxe standard model items plus the additions or substitutions listed below



K10516 closed model with optional 3-passenger rear seat shown in illustration

EXTERIOR

● Bright Appearance Items:

- Brush-finished applique panel on tailgate
- "Chevrolet" nameplate on tailgate applique panel (C-K10514 open models only; base equipment on C-K10516 closed models)
- Front and rear bumpers
- Hub caps
- "Cheyenne" nameplate on each side panel at center rear
- Upper and lower body side and tailgate moldings, plus wheel-

opening lip moldings

Parking lamp, front side marker lamp, and taillamp trim

Removable top side window moldings (included on C-K10516 closed models only)

Windshield reveal molding

● Body-to-Fender Insulators

● Hood Insulator

● Horn: Additional, electric, high-note

C-K10516 closed model with optional 3-passenger rear seat shown in illustration

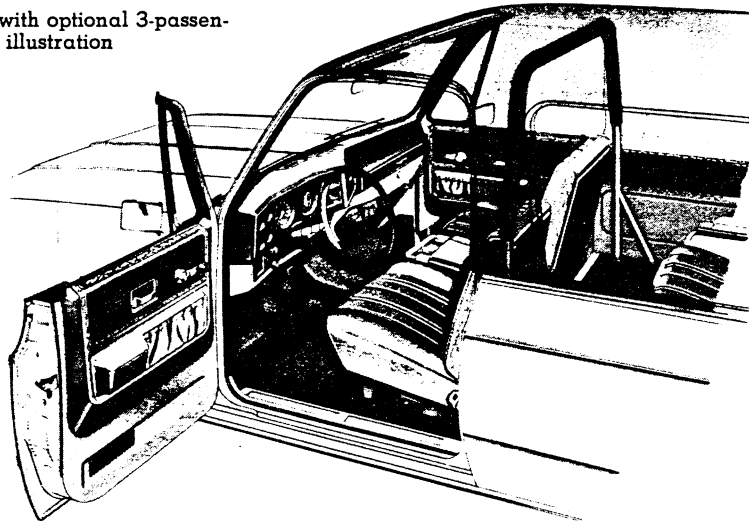

INTERIOR

● Bright Appearance Items:

- "Cheyenne" nameplate on instrument panel pad
- Four-speed transmission shift lever
- Transfer case shift lever (4-wheel-drive models)
- Trim on instrument cluster face plate and on C-K10516 closed model interior trim panels

● Cigar Lighter

- **Floor Covering:** Color-keyed front compartment carpeting (C-K10516 closed models only). Rear compartment floor covering provided only with optional rear seat

- **Instrument Cluster:** Gauges replacing warning lamps for ammeter, engine temperature and oil pressure; includes wood-grain trimmed face plate

- **Seats:** Bucket seats with console for driver and front passenger; includes seat belt with retractor for passenger seat; all-vinyl buffalo hide grain trim in choice of blue, green, sand, saddle, or red (basket weave pattern nylon cloth and vinyl trim in choice of blue or saddle also available when C-K10516 closed model is ordered)

- **Sunshade:** RH padded (C-K10514 open models only)

- **Special Insulator:** Under cowl panel

- **Trim Panels:** (C-K10516 closed models only). Molded, color-keyed plastic front door trim panels with vinyl storage pockets plus woodgrain inserts. Vinyl-coated, color-keyed hardboard rear compartment sidewall trim panels with woodgrain inserts

BLAZER OPTIONAL SEATS

A bucket-type auxiliary front seat (RPO A57) is available for Custom Deluxe (standard) models. This seat includes a seat belt with retractor, RH sunshade (open models only), and is trimmed to match the driver's seat. It is included when the Cheyenne Model Option is ordered.

The driver's seat and auxiliary front seat also are available optionally for Custom Deluxe (standard) models with all-vinyl buffalo hide grain trim in a choice of blue, green, saddle, or red. This option includes a

color-keyed plastic floor console between the seats, color-keyed front carpeting (closed models only), seat belt with retractor for the auxiliary seat, and RH sunshade (open models only).

A three-passenger rear seat (RPO AS3) is available for all models and may be ordered with or without the front passenger seat. Seat belts without retractors, LH and RH ashtrays and armrests, and floor covering are included. The seat is trimmed to match the driver's seat.

SEATING ARRANGEMENTS

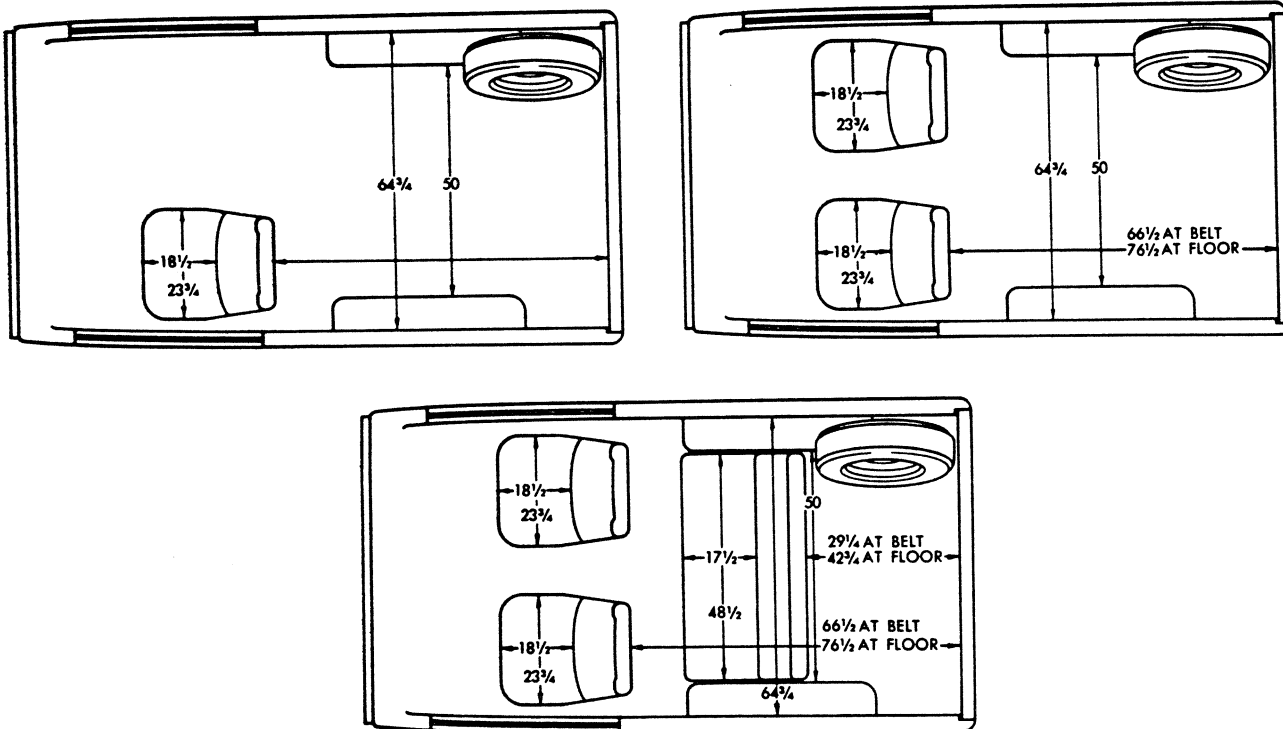

DIMENSIONS

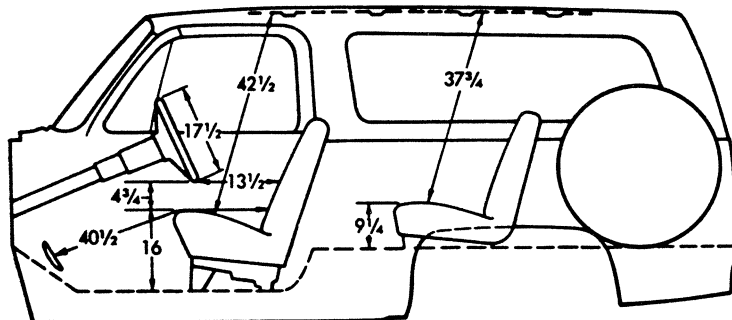

Glass Area (sq. in.)

Windshield.....1447
**Side door, including venti-
 pane (each side)..... 546**

**Removable top side win-
 dow (each side, closed
 models only)..... 894**
**Tailgate drop glass (closed
 models only).....1077**

NOTES

BLAZER

INTERIOR AND EXTERIOR COLOR CHART

All orders for these models must show one of the following interior trim codes on the order form

IMPORTANT

Dealer Note: Exterior and interior combinations shown in chart below are those recommended by Chevrolet; however, any exterior color may be ordered with any available interior color if the particular combination is desired by a customer.

INTERIOR TYPE	Decor Option	INTERIOR TRIM COLOR AND CODE					
		Blue	Green	Red	Saddle	Sand	
Custom Deluxe Vinyl Bucket Seats (Code V)	Std.	VDD2	VGG2	VRR2	VSS2		
Custom Vinyl Bucket Seats (Code W)		XDD2	XGG2	XRR2	XSS2		
Cheyenne Custom Vinyl Bucket Seats (Code W)	ZM	XDD2	XGG2	XRR2	XSS2	XNN2	
Custom Cloth Bucket Seats* (Code D)		LDD2			LSS2		
EXTERIOR COLORS	Primary	Two-Tone Secondary					
Blue, Skyline (Light)	20	12	X		X	X	X
Blue, Hawaiian (Medium)	23	12	X		X	X	X
Blue, Catalina (Dark) (M)	25	12	X		X	X	X
Bronze, Grecian	61	12		X		X	X
Buckskin	62	12	X	X	X	X	X
Gold, Yuba (Medium) (M)	53	12				X	X
Gold, Moss (Dark) (M)	81	12				X	X
Green, Willoway (Light)	43	12		X		X	X
Green, Spring (Medium) (M)	41	12		X		X	X
Green, Glenwood (Dark)	46	12		X		X	X
Red, Crimson (Medium)	73	12			X	X	X
Red, Rosedale (Dark)	71	12			X	X	X
Silver, Saratoga (M)	17	12	X	X	X	X	X
Tan, Santa Fe	60	12	X	X	X	X	X
White, Frost	12	—	X	X	X	X	X

*Custom Cloth Bucket Seats available on CC-CK10516 (closed models) only. (M): Metallic
 ◆ For solid and two-tone color application, see illustrations below. For solid paint, the secondary color is the same as the primary color; for two-tones, Frost White is the secondary color and is applied to the areas shown in the illustrations. Two-tone paint available with white top (Z58) only.

SOLID PAINT—ZY1

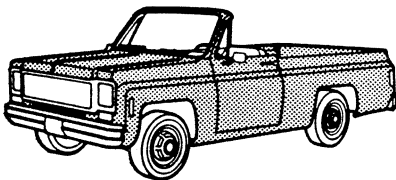

SPECIAL TWO-TONE—ZY3 (Includes YG1 Moldings) Primary Body Color

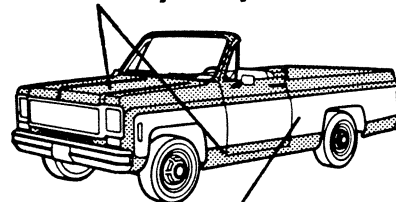

Secondary Body Color

SOLID PAINT—ZY1

Top Color Available in Black or White

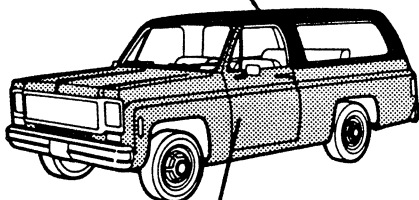

Primary Body Color

SPECIAL TWO-TONE—ZY3 (Includes YG1 Moldings) Top Color Available in White Only Primary Body Color

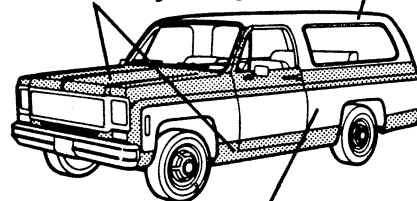

Secondary Body Color

BLAZER

TWO-TONE EXTERIOR COLOR COMBINATIONS*

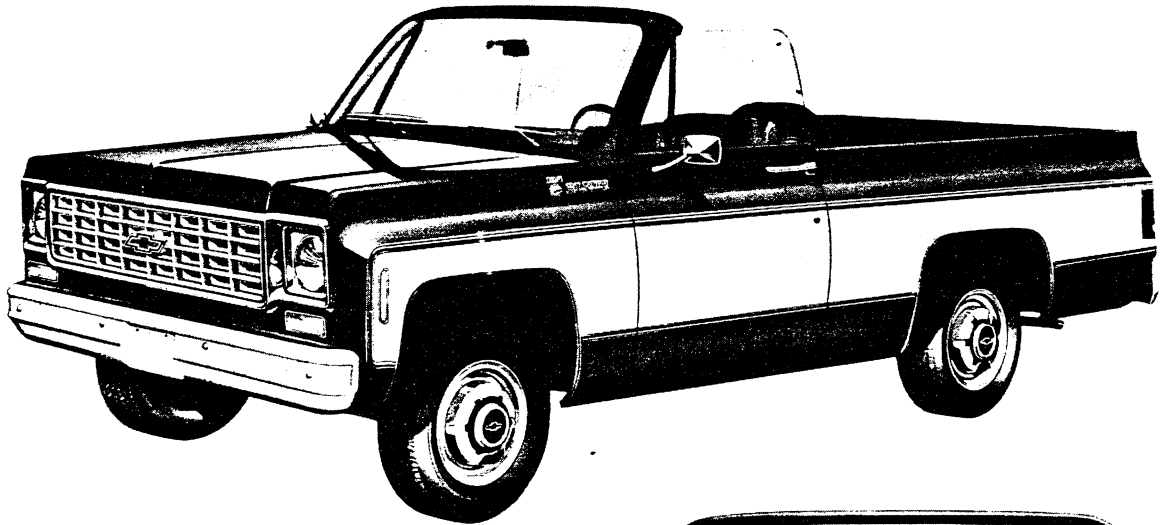

SPECIAL TWO-TONE

Special two-tone (ZY3) paint colors are available on open models and on closed models with white top only. Custom upper and lower moldings are included (except with the Cheyenne Model Option where they are already included). The areas between the moldings are painted Frost White. The areas above and below the moldings are painted the main body color.

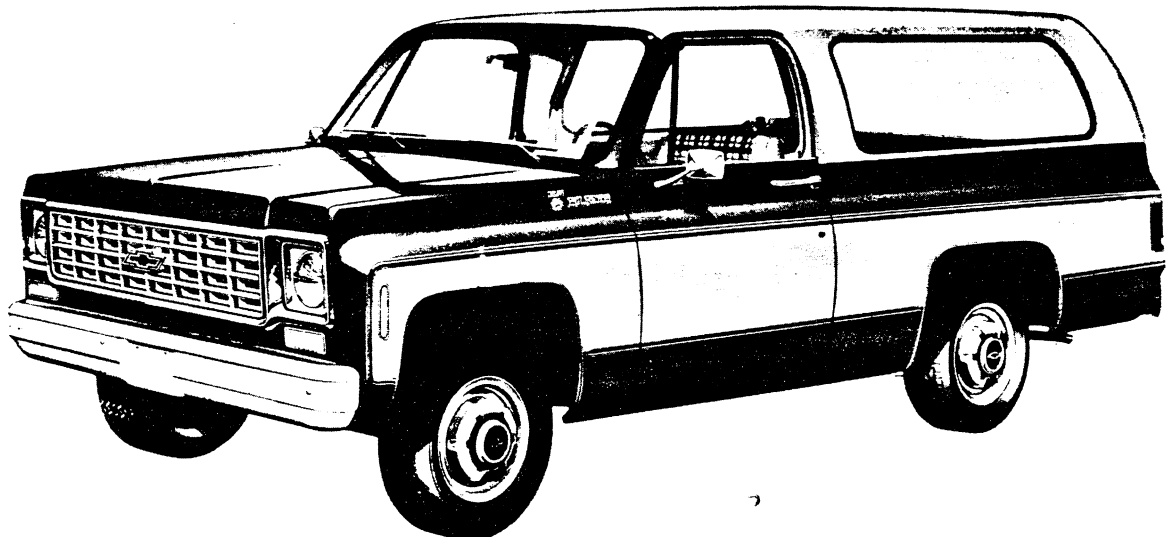

BLAZER

STANDARD SPECIFICATIONS

(See Blue Tab Section for Specification Details)

Series	C10	K10
Engine		
Base Equip.—6 cyl.	250 1-bbl L6	350 4-bbl V8
—8 cyl.	350 2-bbl V8	
Clutch—6 cyl.	11", 124 sq. in.	12", 150 sq. in.
—8 cyl.	11", 124 sq. in.	
Air Filter	Oiled-paper Element Throwaway Type; 1-qt. Single; Aluminized See Engine & Cooling, p.30, for specific model applications	
Oil Filter		
Exhaust System		
Emission Control Systems		
Suspension, Front	Independent	Hypoid Driving Axle
Type	Coil Springs	Leaf Springs
Axle Capacity	3250 lb.	3600 lb.
Axle Ratio—6 cyl.	—	3.07
—8 cyl.	—	1650 lb. ea.
Springs @ Ground	1550 lb. ea.	1" dia.
Shock Absorbers	1" dia.	1" dia.
Stabilizer Bar	—	8 cyl.—1.25" dia.
Suspension, Rear	Hypoid; Two-stage Multi-leaf Springs	
Type	Leaf Springs	Leaf Springs
Axle Capacity	3750 lb.	3750 lb.
Axle Ratio—6 cyl.	4.11	3.07
—8 cyl.	3.40	1700 lb. ea.
Springs, Main @ Ground	1500 lb. ea.	1" dia.
Shock Absorbers	1" dia.	1" dia.
Brakes	Hydraulic; Self-adjusting	
Front	Disc; 11.86" Rotor	Disc; 11.86" Rotor
Rear	Drum; 11" x 2"	Drum; 8 cyl.—11.15" x 2.75"
Booster	Single Diaphragm	8 cyl.—Dual Diaphragm
Parking	Cable to Rear Wheels	
Electrical	12 Volt; Negative Ground	
Battery—6 cyl.	45 amp. hr.; 2300 watts @ 0°F.	
—8 cyl.	61 amp. hr.; 2900 watts @ 0°F.	
Delcotron Generator	37 amp.	
Frame	Carbon Steel; 39,000 psi	
Section Modulus	3.14	
Fuel Tank (nominal capacity)	25 gal.	
Steering Gear Type	Recirculating Ball	
Linkage	Parallelogram	Conventional
Transmission	Fully Synchronized 3-Speed	
Shift Location	Steering Column	
Transfer Case—6 cyl.	—	New Process 203 (Full Time) Single Lever V8—Left side
—8 cyl.	—	
Shift Lever	—	
PTO Opening	—	
Tires	(5) E78-15B (4PR)	8 cyl.—(5) H78-15B (4PR)
Wheels	(5) Disc 15" x 6"	

BLAZER

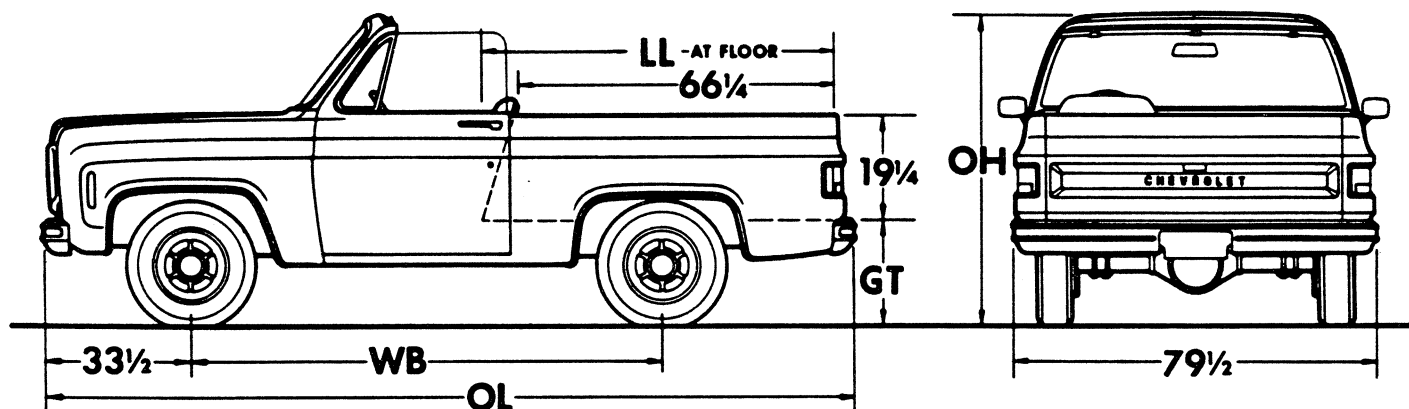

Series	Ground Clearance (in)★	
	Front	Rear
C10	7	7
K10	7	7

Model	Engine No. Cyl.	Dimensions (in) ★					Curb Weight (lb)			Model Weight (lb)*		
		WB	LL	OL	OH	GT	Front	Rear	Total	Front	Rear	Total†

C10 SERIES

CC10514	6	106½	76½	184½	67	27	2007	1614	3621	2074	1697	3921
	8						2134	1640	3774	2201	1723	4074
CC10516	6	106½	76½	184½	69	27	2056	1852	3908	2123	1935	4208
	8						2183	1878	4061	2250	1961	4361

K10 SERIES

CK10514	8	106½	76½	184½	69½	29¼	2315	1864	4179	2382	1947	4479
	8						2364	2102	4466	2431	2185	4766

★Dimensions with standard equipment, unloaded.

*Model Weight includes Curb Weight plus occupants (standard seating capacity x 150 lb).

†Total also includes 150 lb minimum payload allowance.

BLAZER

GVW SELECTOR

†Maximum Ratings			Minimum Equipment Required for GVW Rating		
GVW Rating (lb)	★GAWR (lb)		Tires, Front	Tires, Rear	Chassis Equipment
	Front	Rear			

C10 SERIES

4900	2540	2540	E78-15B(4PR) (TL)	E78-15B(4PR) (TL)	Standard
5200	2940	2940	G78-15B(4PR) (TL or TB)	G78-15B(4PR) (TL or TB)	
5700	3100	3220	H78-15B(4PR) (TL)	H78-15B(4PR) (TL)	HD Rear Springs (G50)
			6.50-16C(6PR) (TB) (TT)	6.50-16C(6PR) (TB) (TT)	

K10 SERIES

6300	3220	3220	H78-15B(4PR) (TL)	H78-15B(4PR) (TL)	Standard
			6.50-16C(6PR) (TB) (TT)	6.50-16C(6PR) (TB) (TT)	

†GAWR's shown are the maximum for each axle. When ordering a truck the total of the actual weight on both front and rear axles cannot exceed the total GVW rating.

★GAWR—Gross Axle Weight Rating

TL—Tubeless TB—Tube Type TT—Truck Type

BLAZER

FRONT AND REAR TIRE AVAILABILITY CHART

Spare tire to match either front or rear tires must be ordered

C10 SERIES

FRONT		REAR			
Description	Option Number		Description Single Rear	Option Number	
	Highway	On-Off Road		Highway	On-Off Road
TUBELESS					
E78-15/B	EV*		E78-15/B	EV*	—
G78-15/B	GS		G78-15/B	GS	GU
G78-15/B White Stripe	GT		G78-15/B White Stripe	GT	—
H78-15/B	HL		H78-15/B	HL	—
H78-15/B White Stripe	HM		H78-15/B White Stripe	HM	—
L78-15/B	LB		L78-15/B	LB	LC
L78-15/B White Stripe	LD		L78-15/B White Stripe	LD	—
LR78-15/C Radial White Stripe	CD		LR78-15/C Radial White Stripe	CD	—
TUBE-TYPE					
G78-15/B	GW		G78-15/B	GW	GV
6.50-16/C (Truck Type)	MG		6.50-16/C (Truck Type)	MG	MD
7.00-15/C (Truck Type)	NH		7.00-15/C (Truck Type)	NH	NG
7.00-16/C (Truck Type)	NK		7.00-16/C (Truck Type)	NK	NL

*Base tire on this series.

K10 SERIES

Front and rear tire tread must match

FRONT			REAR		
Description	Option Number		Description Single Rear	Option Number	
	Highway	On-Off Road		Highway	On-Off Road
TUBELESS					
H78-15/B	HL†	HR	H78-15/B	HL†	HR
H78-15/B White Stripe	HM	—	H78-15/B White Stripe	HM	—
L78-15/B	LB	LC	L78-15/B	LB	LC
L78-15/B White Stripe	LD	—	L78-15/B White Stripe	LD	—
LR78-15/C Radial White Stripe	CD	—	LR78-15/C Radial White Stripe	CD	—
10-15/B	—	WR	10-15/B	—	WR
TUBE-TYPE					
6.50-16/C (Truck Type)	MG	ND	6.50-16/C (Truck Type)	MG	ND
7.00-15/C (Truck Type)	NH	NG	7.00-15/C (Truck Type)	NH	NG
7.00-16/C (Truck Type)	NK	NL	7.00-16/C (Truck Type)	NK	NL

†Base tire on 8 cyl. models.

BLAZER

POWER TEAMS

ENGINE	TRANSMISSION	TRANSFER CASE	REAR AXLE	
Type and Code	Type and Code	Make and Model	Make and Capacity (lb)	Ratio and Code

C10 SERIES

				3.07 HE3	3.40 HE4	3.73 GT4	4.11 H04
■ 250 1-bbl L6—LD4 (Standard Six)	3-Speed Manual (Std)—M15 a	—	Chevrolet 3750 ♦	—	—	X	X(Std)
	4-Speed (Chevrolet CH465)—M20			—	—	X(Std)	X
	Turbo Hydra-matic—M40			—	—	X(Std)	X
● 350 2-bbl V8—LF5 (Standard V8)	3-Speed Manual (Std)—M15			—	X(Std)	—	—
	Turbo Hydra-matic—M40			—	X(Std)	X	—
■ 350 4-bbl V8—LS9	4-Speed (Chevrolet CH465)—M20			—	X(Std)	X	—
	Turbo Hydra-matic—M40	X(Std)	X	—	—		

K10 SERIES

				3.07 HE3	3.73 GT4	4.11 H04
■ 350 4-bbl V8—LS9 (Standard V8)	3-Speed Manual (Std)—M15	New Process #203	Chevrolet 3750 ♦	X(Std)	X	X
	4-Speed (Chevrolet CH465)—M20			X(Std)	X	X
	Turbo Hydra-matic—M40			X(Std)	X	X
■ 400 4-bbl V8—LF4	Turbo Hydra-matic—M40			X(Std)	X	X

- Available for registration in the State of California when California Emission Certification is ordered.
- Not available for registration in the State of California.
- ♦ Locking Differential rear axle also available.
- a Not recommended for GVW of 5700 lb and above.

ENGINE RATINGS

SAE Net Ratings @ 85°F	250 1-bbl L6	350 2-bbl V8	350 4-bbl V8	400 4-bbl V8
Net Horsepower	105 @ 3800 rpm	145 @ 3800 rpm	160 @ 3800 rpm	175 @ 3600 rpm
Net Torque, lb-ft	185 @ 1200 rpm	250 @ 2200 rpm	250 @ 2400 rpm	290 @ 2800 rpm

BLAZER

1975 VEHICLES WITH STANDARD EQUIPMENT

Prices shown are effective with production of 1975 Vehicles

Description	Model Number	Code	Wheel-base	Factory D&H [§]	List Price	Mfr's Suggested Retail Price★	Destination Charge & Group Number	Total
◆ 6-Cylinder 250-1 BBL Engine—Engine Ordering Code LD4								
C10 Series 2-Wheel Drive								
Utility (Without Top)	CC10514	ZW9	106.5"				19	
Utility (With White Top)	CC10516	Z58	106.5"				19	
Utility (With Black Top)	CC10516	Z59	106.5"				19	
◆ 8-Cylinder 350-2 BBL Engine—Engine Ordering Code LF5								
C10 Series 2-Wheel Drive								
Utility (Without Top)	CC10514	ZW9	106.5"				19	
Utility (With White Top)	CC10516	Z58	106.5"				19	
Utility (With Black Top)	CC10516	Z59	106.5"				19	
◆ 8-Cylinder 350-4 BBL Engine—Engine Ordering Code LS9								
K10 Series 4-Wheel Drive								
Utility (Without Top)	CK10514	ZW9	106.5"				20	
Utility (With White Top)	CK10516	Z58	106.5"				20	
Utility (With Black Top)	CK10516	Z59	106.5"				20	

★ Manufacturer's Suggested Retail Prices do not include applicable destination charges, state and local taxes, license fees, options or accessories.
 ◆ Refer to Power Team Chart for California Emission Certification Requirements.

OPTIONS AND ACCESSORIES WHEN INSTALLED BY CHEVROLET

Prices shown are effective with production of 1975 Vehicles

Description	Added Weight (F) (R)	Option Number	Factory D&H [§]	List Price	Mfr's Suggested Retail Price◇
-------------	-------------------------	---------------	--------------------------	------------	-------------------------------

POWER TEAMS AND AXLES

(See Power Teams Chart for availability and complete specifications)

Engines:

350-4 BBL V8. V8 C10 series only. Available only when optional transmission is specified	4	0	LS9	
400-4 BBL V8. V8 K10 series only. Available only when M40 Turbo Hydra-matic transmission is specified	12	27	LF4	

Liquid Petroleum Gas Conversion: All 1975 Chevrolet Light Duty Truck gasoline production engines may be converted to use LP Gas when permissible under Federal and State laws and regulations without causing harmful effect to the engine. Complete conversion to LPG requires adaptation by a local distributor who sells and services LPG equipment. Caution should be exercised so that the fuel tank is mounted on and is vented to the outside of the vehicle. In addition, vehicles converted to LPG should not be stored in enclosed places such as garages.

Transmissions:

<i>Turbo Hydra-matic.</i>				
C10 series only.				
With LD4 250-1 BBL engine	22	7	M40	
With V8 engine	20	6	M40	
K10 series only.				
With V8 engine	108	37	M40	
<i>Chevrolet 4-Speed.</i>				
C10 series only. Not available when LF5 350-2 BBL engine is specified				
K10 series only. Available only when LS9 350-4 BBL engine is specified	78	21	M20	
	112	38	M20	

Axles, Rear:

Optional Ratio . (See Power Teams Chart for option number selection, availability and complete specifications)	0	0		
Locking Differential	0	3	G80	

§ D&H amounts reflect provision for pass through of tire weight tax imposed on manufacturer or importer of tires.

◇ State and local taxes not included.

BLAZER

OPTIONS AND ACCESSORIES WHEN INSTALLED BY CHEVROLET

Prices shown are effective with production of 1975 Vehicles

Description	Added Weight (F) (R)	Option Number	Factory D&H ¹	List Price	Mfr's Suggested Retail Price [◇]
-------------	-------------------------	---------------	--------------------------	------------	---

MODEL OPTION

(See Interior and Exterior Color Selection Chart)

Cheyenne: Includes V37 front and rear bumpers; bright windshield, YG1 body side upper and lower moldings, upper and lower tailgate, wheel opening, front turn signals, front side markers and taillight moldings; nameplates on front fenders, rear side panel and instrument panel; bright tailgate applique; P03 hub caps;

console; U37 cigarette lighter; wood-grained instrument cluster with Z53 ammeter, temperature and oil pressure gauges; door actuated courtesy light; dual horns plus special body insulation.

CC10514 or CK10514 only. Also includes RH sunshade

C10 series only.

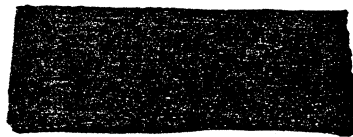
Without AS3 rear seat	107	126	Z84	
With AS3 rear seat	103	121	Z84	

K10 series only.

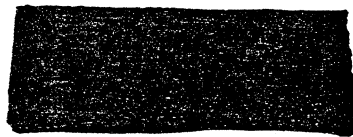
Without AS3 rear seat	109	128	Z84	
With AS3 rear seat	105	123	Z84	

CC10516 or CK10516 only. Also includes bright side window moldings; plastic door trim panels with storage pockets and wood-grained accents; vinyl coated hardboard rear side trim panels with wood-grained accents and front color-keyed carpeting.

C10 series only.

Without AS3 rear seat	107	136	Z84	
With AS3 rear seat	103	131	Z84	

K10 series only.

Without AS3 rear seat	109	138	Z84	
With AS3 rear seat	105	133	Z84	

OTHER OPTIONS

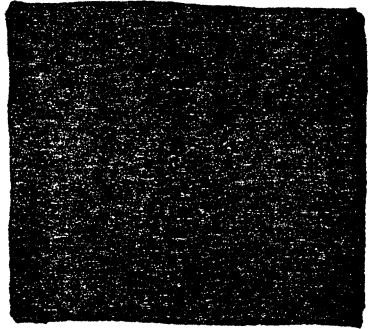
Air Cleaner: Poly-Wrap	0	0	K43	
-------------------------------------	---	---	-----	---

Air Conditioning: All-Weather. Includes extra cooling and K76 61-amp generator.

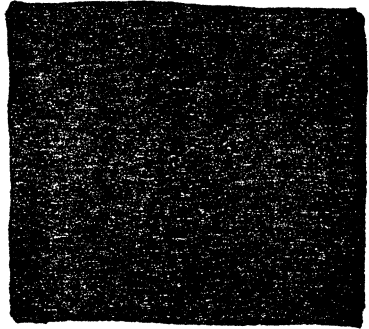
Without LS9 350-4 BBL engine	89	10	C60	
With LS9 350-4 BBL engine	95	10	C60	

Bar, Padded Roll: Standard on CC10516 and CK10516. Mounted behind front seat(s).

.....	12	29	E50	
-------	----	----	-----	---

Batteries: 12-volt.

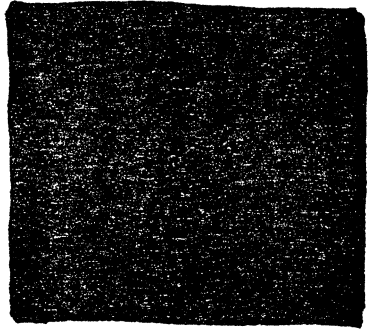
<i>Auxiliary.</i> 61-amp-hr, 9-plate	53	-9	TP2	
--	----	----	-----	---

Heavy-Duty. 80-amp-hr, 15-plate. Included when Z82 Trailering Special or Z56 Cold-Climate Package is specified.

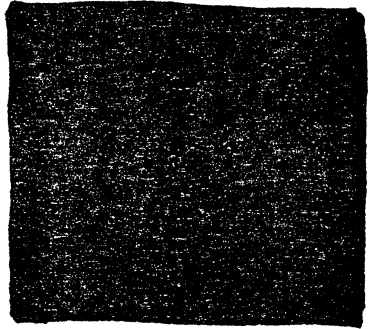
With LD4 250-1 BBL engine	14	-2	UA1	
With V8 engine	2	0	UA1	

Bumper Equipment: Chromed.

Bumpers, Front and Rear. Included when Z84 Cheyenne is specified

.....	0	0	V37	
-------	---	---	-----	---

Guards, Front Bumper. Available only when V37 bumpers or Z84 Cheyenne is specified.

.....	11	-2	V31	
-------	----	----	-----	---

California Emission Certification: Includes all testing, equipment and /or certification necessary for registration in the State of California. (See Power Teams Chart for availability and complete specifications)

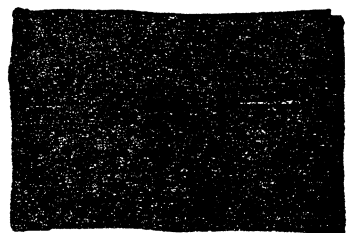
K10 series	0	0	YF5	
C10 series	0	0	YF5	

Carpeting, Wheelhouse: CC10516 or CK10516 only. Available only when AS3 rear seat and custom vinyl or custom cloth interior trim is specified.

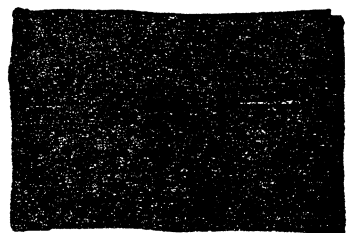
.....	0	11	BG7	
-------	---	----	-----	---

Clock, Electric: Not available when U16 tachometer is specified.

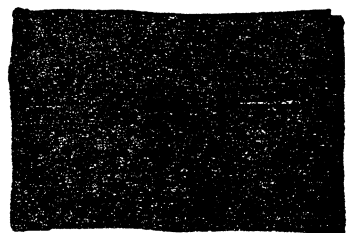
Without Z84 Cheyenne. Includes Z53 ammeter, temperature and oil pressure gauges	1	0	U35	
With Z84 Cheyenne	0	0	U35	

¹ D&H amounts reflect provision for pass through of tire weight tax imposed on manufacturer or importer of tires.

[◇] State and local taxes not included.

BLAZER

OPTIONS AND ACCESSORIES WHEN INSTALLED BY CHEVROLET

Prices shown are effective with production of 1975 Vehicles

Description	Added Weight (F) (R)	Option Number	Factory D&H [†]	List Price	Mfr's Suggested Retail Price [◇]
OTHER OPTIONS					
Cold-Climate Package: Not available when C60 air conditioning or K79 42-amp generator is specified. Includes 55-amp generator, super heater and defroster, engine block heater and anti-freeze to -40 degrees.					
With LD4 250-1 BBL engine. Also includes UA1 HD battery. . . .	16	-2	Z56		
With V8 engine.					
Without Z82 Trailing Special. Also includes UA1 HD battery	4	0	Z56		
With Z82 Trailing Special.	2	0	Z56		
Cooler, Engine Oil: Available only when V8 engine is specified	13	-1	KC4		
Cooling: Radiator, Heavy-Duty: Not available when LF4 400-4 BBL engine or C60 air conditioning is specified.					
With LD4 250-1 BBL engine	4	-1	V01		
With V8 engine	8	-1	V01		
Gauges:					
<i>Ammeter, Temperature and Oil Pressure.</i> Included when Z84 Cheyenne, U16 tachometer or U35 electric clock is specified. . . .					
Tachometer. Available only when V8 engine is specified. Not available when U35 electric clock is specified.	1	0	Z53		
Without Z84 Cheyenne. Includes Z53 ammeter, temperature and oil pressure gauges.	2	0	U16		
With Z84 Cheyenne	1	0	U16		
Generators:					
<i>42-amp Delcotron.</i> Not available when C60 air conditioning or Z56 Cold-Climate Package is specified.					
Cold-Climate Package is specified.	0	0	K79		
<i>61-amp Delcotron.</i> Included when C60 air conditioning is specified.					
Without Z56 Cold-Climate Package.	1	0	K76		
With Z56 Cold-Climate Package	1	0	K76		
Glass:					
<i>Sliding Side Window.</i> CC10516 or CK10516 only.					
Soft-Ray Tinted. All Windows.					
CC10514 or CK10514 only.	0	0	A01		
CC10516 or CK10516 only.	0	0	A01		
<i>Grille: Chromed</i>					
	0	0	V22		
Guards, Door Edge: Not available when YG2 wood-grained exterior trim is specified					
	0	0	B93		
Harness, Trailer Wiring: Heavy-Duty.					
	0	2	UY7		
Headlamp Warning Buzzer.					
	0	0	T63		
Instrument Panel, Wood-Grained: Available only when Z53 ammeter, temperature and oil pressure gauges are specified. Not available when Z84 Cheyenne is specified.					
	0	0	BC2		
Lighter, Cigarette: Included when Z84 Cheyenne is specified					
	0	0	U37		
Mirrors, Exterior: LH and RH.					
<i>Below-Eye-Line Type.</i> 7.5" x 10.5". Provides field of vision for vehicles to 80" wide.					
Painted	3	1	D29		
Stainless Steel	3	1	DG4		
<i>Camper Type.</i> Stainless steel. Includes below-eye-line mirrors with adjustable arm feature to provide field of vision for vehicles to 96" wide. Shipped loose for dealer installation.					
	7	2	DF2		

[†] D&H amounts reflect provision for pass through of tire weight tax imposed on manufacturer or importer of tires.
[◇] State and local taxes not included.

BLAZER

OPTIONS AND ACCESSORIES WHEN INSTALLED BY CHEVROLET

Prices shown are effective with production of 1975 Vehicles

Description	Added Weight (F) (R)	Option Number	Factory D&H [‡]	List Price	Mfr's Suggested Retail Price [◇]
OTHER OPTIONS					
Moldings:					
<i>Body Side Spear.</i> Bright with black insert. Not available when ZY3 special two-tone paint, B85 body side upper or YG1 upper and lower moldings are specified.	0	0	B84		
<i>Body Side Upper.</i> Not available when Z84 Cheyenne, ZY3 special two-tone paint or YG2 wood-grained exterior trim is specified. Includes fender, door, rear side panel and tailgate moldings plus bright front turn signal, front side marker and taillight trim.	2	3	B85		
<i>Body Side Upper and Lower.</i> Included when Z84 Cheyenne, ZY3 special two-tone paint or YG2 wood-grain trim is specified. Includes B85 body side upper moldings described above plus lower body side, tailgate and wheel opening moldings tailgate and wheel opening moldings.	3	4	YG1		
Paints, Exterior: See Interior and Exterior Color Selection Chart for ordering information					
<i>Solid</i>	0	0	ZY1		
<i>Special Two-Tone.</i> Area between upper and lower side moldings painted white. Not available when Z59 black top series or YG2 wood grained exterior trim is specified					
Without Z84 Cheyenne. Includes YG1 body side upper and lower moldings	3	4	ZY3		
With Z84 Cheyenne	0	0	ZY3		
Plate, Fuel Tank Shield:					
C10 series only	-8	53	NY1		
K10 series only. Includes transfer case skid plate	9	53	NY1		
Plate: Serial Number (State of Pennsylvania) *K* Plate. Available only when GS, GT or GU G78-15 or larger tires are specified.	0	0	Z55		
Radios: Pushbutton. Includes antenna.					
<i>AM</i>	7	2	U63		
<i>AM /FM</i>	7	2	U69		

[‡] D&H amounts reflect provision for pass through of tire weight tax imposed on manufacturer or importer of tires.
[◇] State and local taxes not included.

BLAZER

OPTIONS AND ACCESSORIES WHEN INSTALLED BY CHEVROLET

Prices shown are effective with production of 1975 Vehicles

Description	Added Weight (F) (R)	Option Number	Factory D&H [†]	List Price	Mfr's Suggested Retail Price [◇]
OTHER OPTIONS					
Seats:					
<i>Front</i>					
<i>Auxiliary, One-Passenger.</i> Included when custom vinyl bucket seats or Z84 Cheyenne is specified. Includes seat belt.					
CC10514 or CK10514 only. Also includes RH sunshade.					
Without AS3 rear seat	91 113	A57			
With AS3 rear seat	87 108	A57			
CC10516 or CK10516 only.					
Without AS3 rear seat	91 113	A57			
With AS3 rear seat	87 108	A57			
<i>Custom Vinyl, Driver and Passenger.</i> Available only when Z84 Cheyenne is specified. Includes console, RH sunshade and seat belts. See Interior and Exterior Color Selection Chart for availability and ordering information.					
CC10514 or CK10514 only.					
Without AS3 rear seat	91 113				
With AS3 rear seat	87 108				
CC10516 or CK10516 only. Also includes front compartment color-keyed carpeting.					
Without AS3 rear seat	91 113				
With AS3 rear seat	87 108				
<i>Custom Cloth, Driver and Passenger.</i> CC10516 or CK10516 only. Available only when Z84 Cheyenne is specified. See Interior and Exterior Color Selection Chart for availability and ordering information.					
Without AS3 rear seat	0 0				
With AS3 rear seat	0 0				
<i>Rear, 3-Passenger.</i> Available only when GS, GT or GU G78-15 or larger tires are specified. Seat trim matches front seat. Includes LH and RH rear armrests with ashtrays, floor covering, floor insulation and (3) seat belts. With standard front seat also includes black embossed rubber rear floor mats. CC10516 or CK10516 with custom seats or Z84 Cheyenne also includes color-keyed rear floor carpeting. CC10514 or CK10514 with custom seats or Z84 Cheyenne also includes black rubber rear floor mats.					
	16 573	AS3			
Shock Absorbers: Heavy-Duty.					
<i>Front and Rear.</i>					
C10 series only	5 4	F51			
K10 series only	3 3	F51			
<i>Rear</i>	0 3	G68			
Speed and Cruise Control: Available only when M40 Turbo Hydra-matic transmission is specified.					
	5 0	K30			
Springs: Heavy-Duty.					
<i>Front.</i>					
Capacity 1625-lb each. C10 series only	10 0	F60			
Capacity 1900-lb each. K10 series only	24 0	F60			
<i>Rear.</i> Capacity 1700-lb each. C10 series only.	0 22	G50			
Stabilizers:					
<i>Front.</i> 1" diameter. C10 series only	19 0	F59			
Steering, Power: Included when Z82 Trailering Special is specified.					
C10 series only.					
With LD4 250-1 BBL engine	35 0	N41			
With V8 engine	29 0	N41			
K10 series only	33 0	N41			
Steering Wheels:					
<i>Comfortilt.</i> Available only when optional transmission is specified.					
With M20 4-Speed transmission	3 1	N33			
With M40 Turbo Hydra-matic transmission	2 0	N33			
<i>Custom.</i> 18". Available only when N41 power steering is specified	0 0	N31			

[†] D&H amounts reflect provision for pass through of tire weight tax imposed on manufacturer or importer of tires.
[◇] State and local taxes not included.

BLAZER

OPTIONS AND ACCESSORIES WHEN INSTALLED BY CHEVROLET

Prices shown are effective with production of 1975 Vehicles

Description	Added Weight (F) (R)	Option Number	Factory D&H [‡]	List Price	Mfr's Suggested Retail Price [◇]
OTHER OPTIONS					
Tank, Fuel: Approximately 30-gallon capacity. Replaces production fuel tank.	-7 51	NK7			
Throttle Control: Manual	1 0	K31			
Tires and Wheels: See following pages					
Towing Device: Two front towing hooks. K10 series only	16 -3	V76			
Trailer Hitch:					
<i>Deadweight Type</i>	-10 35	VR2			
<i>Weight Distributing Platform Type</i>	-16 61	VR4			
Trailer Special: Available only when V8 engine with optional transmission, K76 61-amp generator and V01 heavy-duty radiator or C60 air conditioning are specified. Includes N41 power steering, UA1 HD battery and trailering special nameplate. <i>See Chart A on the Trailering Special Package page for Blazer, under the Recreational Vehicles Tab, for GCW ratings with available power team combinations.</i>					
C10 series only. Available only when G50 HD rear springs, HL, HM or HR H78-15 or larger tires are specified	31 0	Z82			
K10 series only	35 0	Z82			
Wheel Trim: Bright Metal.					
<i>Hub Caps.</i> Included when Z84 Cheyenne is specified.					
C10 series only	0 0	P03			
K10 series only	2 2	P03			
<i>Trim Rings.</i> Available only when Z84 Cheyenne or P03 hub caps are specified.	2 2	P06			
Wheel Covers. Not available when CD LR78-15 radial tires are specified.					
C10 series only.					
Without Z84 Cheyenne.					
Without MG or MD 6.50-16 or NK or NL 7.00-16 tires.	4 4	P01			
With MG or MD 6.50-16 or NK or NL 7.00-16 tires. Includes P06 trim rings	6 6	P01			
With Z84 Cheyenne.					
Without MG or MD 6.50-16 or NK or NL 7.00-16 tires.	6 6	P01			
With MG or MD 6.50-16 or NK or NL 7.00-16 tires. Includes P06 trim rings	6 6	P01			
K10 series only. Not available when F76 hubs, WR 10-15 or CD LR78-15 tires are specified. Front units contain hub clearance holes.					
Without Z84 Cheyenne.					
Without MG or MD 6.50-16 or NK or NL 7.00-16 tires.	6 6	P01			
With MG or MD 6.50-16 or NK or NL 7.00-16 tires. Includes P06 trim rings	8 8	P01			
With Z84 Cheyenne.					
Without MG or MD 6.50-16 or NK or NL 7.00-16 tires.	6 6	P01			
With MG or MD 6.50-16 or NK or NL 7.00-16 tires. Includes P06 trim rings	8 8	P01			
Wheels, Rally: Not available when EV E78-15, NH or NG 7.00-15, MG or MD 6.50-16 or NK or NL 7.00-16 tires are specified. Includes special hub caps and P06 trim rings.					
Without Z84 Cheyenne.					
C10 series only. Also includes 15" x 7" wheels	3 7	N67			
K10 series only.					
Without WR 10-15 tires. Also includes 15" x 7" wheels.	5 10	N67			
With WR 10-15 tires. Also includes 15" x 8" wheels	7 13	N67			
With Z84 Cheyenne.					
C10 series only. Also includes 15" x 7" wheels	3 7	N67			
K10 series only.					
Without WR 10-15 tires. Also includes 15" x 7" wheels.	5 10	N67			
With WR 10-15 tires. Also includes 15" x 8" wheels	7 13	N67			
Wood-Grained Exterior Trim: Not available when ZY3 special two-tone paint is specified. Includes bright Chevrolet nameplate					
Without Z84 Cheyenne. Includes YG1 body side upper and lower moldings	3 4	YG2			
With Z84 Cheyenne	0 0	YG2			

[‡] D&H amounts reflect provision for pass through of tire weight tax imposed on manufacturer or importer of tires.
[◇] State and local taxes not included.

BLAZER

FACTORY INSTALLED TIRES

See Tire Compatibility Chart for Available Front/Rear Combinations.
Spare tire available to match either front or rear tires.
Prices shown are effective with production of 1975 Vehicles

Tire Size Type	Rim Width Included In Tire Option	Added Weight (F) (R)	Option Number	Factory D&Hs	List Price	Mfr's Suggested Retail Price ◊
C10 SERIES						
TUBELESS TIRES USED WITH SINGLE REAR WHEELS						
E78-15 /B Passenger Type. Maximum Tire Capacity (Each)—Front (1270) Rear (1270)						
Highway Bias Belted Ply Blackwall						
Front (Standard)	6.00	0 0	XEV			
Rear (Standard)	6.00	0 0	YEV			
Spare (Standard)	6.00	0 0	ZEV			
G78-15 /B Passenger Type. Maximum Tire Capacity (Each)—Front (1470) Rear (1470)						
Highway Bias Belted Ply Blackwall						
Front	6.00	7 0	XGS			
Rear	6.00	0 7	YGS			
Spare	6.00	-1 5	ZGS			
Highway Bias Belted Ply White Stripe						
Front	6.00	7 0	XGT			
Rear	6.00	0 7	YGT			
Spare	6.00	-1 5	ZGT			
On-Off Road Bias Belted Ply Blackwall						
Rear	6.00	0 12	YGU			
Spare	6.00	-2 9	ZGU			
H78-15 /B Passenger Type. Maximum Tire Capacity (Each)—Front (1610) Rear (1610)						
Highway Bias Belted Ply Blackwall						
Front	6.00	12 0	XHL			
Rear	6.00	0 12	YHL			
Spare	6.00	-2 9	ZHL			
Highway Bias Belted Ply White Stripe						
Front	6.00	12 0	XHM			
Rear	6.00	0 12	YHM			
Spare	6.00	-2 9	ZHM			
On-Off Road Bias Belted Ply Blackwall						
Rear	6.00	0 17	YHR			
Spare	6.00	-2 11	ZHR			
L78-15 /B Passenger Type. Maximum Tire Capacity (Each)—Front (1790) Rear (1790)						
Highway Bias Belted Ply Blackwall						
Front	6.00	16 0	XLB			
Rear	6.00	0 16	YLB			
Spare	6.00	-2 10	ZLB			
Highway Bias Belted Ply White Stripe						
Front	6.00	17 0	XLD			
Rear	6.00	0 17	YLD			
Spare	6.00	-2 11	ZLD			
On-Off Road Bias Belted Ply Blackwall						
Rear	6.00	0 20	YLC			
Spare	6.00	-3 14	ZLC			
LR78-15 /C Passenger Type. Maximum Tire Capacity (Each)—Front (1900) Rear (1900)						
Highway Steel Belted Radial Ply White Stripe						
Front	6.00	28 0	XCD			
Rear	6.00	0 28	YCD			
Spare	6.00	-3 17	ZCD			

§ D&H amounts reflect provision for pass through of tire weight tax imposed on manufacturer or importer of tires.
◊ State and local taxes not included.

BLAZER

FACTORY INSTALLED TIRES

See Tire Compatibility Chart for Available Front/Rear Combinations.
Spare tire available to match either front or rear tires.
Prices shown are effective with production of 1975 Vehicles

Tire Size Type	Rim Width Included In Tire Option	Added Weight (F) (R)	Option Number	Factory D&H [§]	List Price	Mfr's Suggested Retail Price ◊
----------------	-----------------------------------	----------------------	---------------	--------------------------	------------	--------------------------------

C10 SERIES

TUBE-TYPE TIRES USED WITH SINGLE REAR WHEELS

G78-15 /B Passenger Type. Maximum Tire Capacity (Each)— Front (1470) Rear (1470)

Highway Bias Belted Ply Blackwall

Front	6.00	8	0	XGW	
Rear	6.00	0	8	YGW	
Spare	6.00	-2	10	ZGW	

On-Off Road Bias Belted Ply Blackwall

Rear	6.00	0	10	YGV	
Spare	6.00	-2	9	ZGV	

6.50-16 /C (6 PR) Truck Type. Maximum Tire Capacity (Each)— Front (1610) Rear (1610)

Highway Nylon Blackwall

Front	5.00	22	0	XMG	
Rear	5.00	0	22	YMG	
Spare	5.00	-3	14	ZMG	

On-Off Road Nylon Blackwall

Rear	5.00	0	30	YMD	
Spare	5.00	-4	20	ZMD	

7.00-15 /C (6 PR) Truck Type. Maximum Tire Capacity (Each)— Front (1720) Rear (1720)

Highway Nylon Blackwall

Front	6.00	20	0	XNH	
Rear	6.00	0	20	YNH	
Spare	6.00	-3	16	ZNH	

On-Off Road Nylon Blackwall

Rear	6.00	0	26	YNG	
Spare	6.00	-5	25	ZNG	

7.00-16 /C (6 PR) Truck Type. Maximum Tire Capacity (Each)— Front (1800) Rear (1800)

Highway Nylon Blackwall

Front	5.00	54	0	XNK	
Rear	5.00	0	54	YNK	
Spare	5.00	-4	10	ZNK	

On-Off Road Nylon Blackwall

Rear	5.00	0	66	YNL	
Spare	5.00	-4	21	ZNL	

[§] D&H amounts reflect provision for pass through of tire weight tax imposed on manufacturer or importer of tires,
◊ State and local taxes not included.

BLAZER

FACTORY INSTALLED TIRES

See Tire Compatibility Chart for Available Front/Rear Combinations.
Spare tire available to match either front or rear tires.
Prices shown are effective with production of 1975 Vehicles

Tire Size Type	Rim Width Included In Tire Option	Added Weight (F) (R)		Option Number	Factory D&H [§]	List Price	Mfr's Suggested Retail Price ◊
K10 SERIES							
TUBELESS TIRES USED WITH SINGLE REAR WHEELS							
H78-15 /B Passenger Type. Maximum Tire Capacity (Each)—Front (1610) Rear (1610)							
Highway Bias Belted Ply Blackwall							
Front							
With V8 engine (Standard).....	6.00	0	0	XHL			
Rear							
With V8 engine (Standard).....	6.00	0	0	YHL			
Spare							
With V8 engine (Standard).....	6.00	0	0	ZHL			
Highway Bias Belted Ply White Stripe							
Front							
With V8 engine.....	6.00	2	0	XHM			
Rear							
With V8 engine.....	6.00	0	2	YHM			
Spare							
With V8 engine.....	6.00	-2	9	ZHM			
On-Off Road Bias Belted Ply Blackwall							
Front							
With V8 engine.....	6.00	5	0	XHR			
Rear							
With V8 engine.....	6.00	0	5	YHR			
Spare							
With V8 engine.....	6.00	-2	11	ZHR			

[§] D&H amounts reflect provision for pass through of tire weight tax imposed on manufacturer or importer of tires.
◊ State and local taxes not included.

BLAZER

FACTORY INSTALLED TIRES

See Tire Compatibility Chart for Available Front/Rear Combinations.
Spare tire available to match either front or rear tires.
Prices shown are effective with production of 1975 Vehicles

Tire Size Type	Rim Width Included in Tire Option	Added Weight (F) (R)	Option Number	Factory D&H's	List Price	Mfr's Suggested Retail Price ◊
----------------	-----------------------------------	----------------------	---------------	---------------	------------	--------------------------------

K10 SERIES

TUBELESS TIRES USED WITH SINGLE REAR WHEELS

L78-15 /B Passenger Type. Maximum Tire Capacity (Each)—Front (1790) Rear (1790)

Highway Bias Belted Ply Blackwall

Front						
With V8 engine	6.00	4 0	XLB			
Rear						
With V8 engine	6.00	0 4	YLB			
Spare						
With V8 engine	6.00	-2 10	ZLB			

Highway Bias Belted Ply White Stripe

Front						
With V8 engine	6.00	5 0	XLD			
Rear						
With V8 engine	6.00	0 5	YLD			
Spare						
With V8 engine	6.00	-2 11	ZLD			

On-Off Road Bias Belted Ply Blackwall

Front						
With V8 engine	6.00	8 0	XLC			
Rear						
With V8 engine	6.00	0 8	YLC			
Spare						
With V8 engine	6.00	-3 14	ZLC			

LR78-15 /C Passenger Type. Maximum Tire Capacity (Each)—Front (1910) Rear (1910)

Highway Steel Belted Radial Ply White Stripe

Front						
With V8 engine	6.00	16 0	XCD			
Rear						
With V8 engine	6.00	0 16	YCD			
Spare						
With V8 engine	6.00	-3 17	ZCD			

TUBELESS WIDE BASE TYPE TIRES USED WITH SINGLE REAR WHEELS

10-15 /B (4 PR) Truck Type. Maximum Tire Capacity Each—Front (1760) Rear (1760)

On-Off Road Bias Belted Ply Blackwall

Front						
With V8 engine	8.00	34 0	XWR			
Rear						
With V8 engine	8.00	0 34	YWR			
Spare						
With V8 engine	8.00	-5 28	ZWR			

D&H amounts reflect provision for pass through of tire weight tax imposed on manufacturer or importer of tires.
State and local taxes not included.

BLAZER

FACTORY INSTALLED TIRES

See Tire Compatibility Chart for Available Front/Rear Combinations.
Spare tire available to match either front or rear tires.
Prices shown are effective with production of 1975 Vehicles

Tire Size Type	Rim Width Included In Tire Option	Added Weight (F) (R)	Option Number	Factory D&H [†]	List Price	Mfr's Suggested Retail Price [◇]
K10 SERIES						
TUBE-TYPE TIRES USED WITH SINGLE REAR WHEELS						
6.50-16 /C (6 PR) Truck Type. Maximum Tire Capacity (Each)— Front (1610) Rear (1610)						
Highway Nylon Blackwall						
Front						
With V8 engine.....	5.00	8 0	XMG			
Rear						
With V8 engine.....	5.00	0 8	YMG			
Spare						
With V8 engine.....	5.00	-3 14	ZMG			
On-Off Road Nylon Blackwall						
Front						
With V8 engine.....	5.00	3 0	XMD			
Rear						
With V8 engine.....	5.00	0 3	YMD			
Spare						
With V8 engine.....	5.00	-4 20	ZMD			
7.00-15 /C (6 PR) Truck Type. Maximum Tire Capacity (Each)— Front (1720) Rear (1720)						
Highway Nylon Blackwall						
Front						
With V8 engine.....	6.00	8 0	XNH			
Rear						
With V8 engine.....	6.00	0 8	YNH			
Spare						
With V8 engine.....	6.00	-4 14	ZNH			
On-Off Road Nylon Blackwall						
Front						
With V8 engine.....	6.00	14 0	XNG			
Rear						
With V8 engine.....	6.00	0 14	YNG			
Spare						
With V8 engine.....	6.00	-4 17	ZNG			

[†] D&H amounts reflect provision for pass through of tire weight tax imposed on manufacturer or importer of tires.
[◇] State and local taxes not included.

BLAZER

FACTORY INSTALLED TIRES

See Tire Compatibility Chart for Available Front/Rear Combinations.
Spare tire available to match either front or rear tires.
Prices shown are effective with production of 1975 Vehicles

Tire Size Type	Rim Width Included in Tire Option	Added Weight (F) (R)	Option Number	Factory D&H [†]	List Price	Mfr's Suggested Retail Price \diamond
----------------	-----------------------------------	----------------------	---------------	--------------------------	------------	---

K10 SERIES

TUBE-TYPE TIRES USED WITH SINGLE REAR WHEELS

7.00-16 /C (6 PR) Truck Type. Maximum Tire Capacity (Each)— Front (1800) Rear (1800)

Highway Nylon Blackwall

Front

With V8 engine. 5.00 42 0 XNK

Rear

With V8 engine. 5.00 0 42 YNK

Spare

With V8 engine. 5.00 -6 32 ZNK

On-Off Road Nylon Blackwall

Front

With V8 engine. 5.00 54 0 XNL

Rear

With V8 engine. 5.00 0 54 YNL

Spare

With V8 engine. 5.00 -7 39 ZNL

[†] D&H amounts reflect provision for pass through of tire weight tax imposed on manufacturer or importer of tires,
 \diamond State and local taxes not included.

