

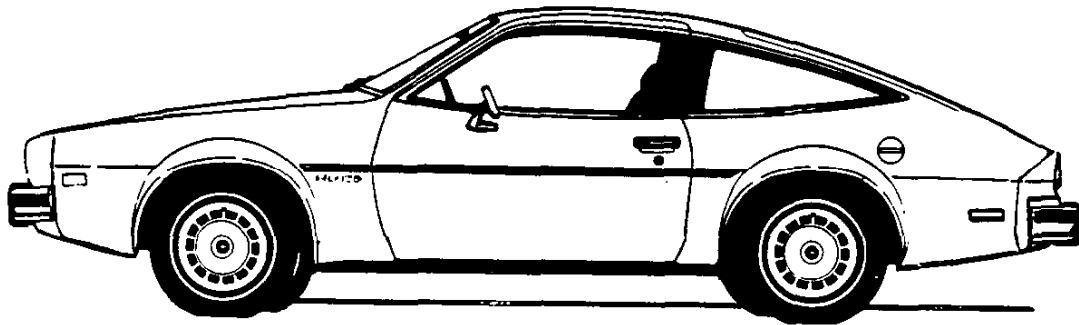

2 + 2 HATCHBACK COUPE 1HM07

GENERAL



MODEL IDENTIFICATION	2
SERIAL NUMBERS AND IDENTIFICATION	3
EXTERIOR EQUIPMENT	4-5-6
INTERIOR EQUIPMENT	7-8-9
EXTRA COST EQUIPMENT	10-11
SPYDER OPTION - RPO Z29	12
MONZA DELUXE INTERIOR - RPO B18	13
MONZA EXTERIOR DECOR PACKAGE - RPO ZM5	13
AIR CONDITIONING EQUIPMENT	14

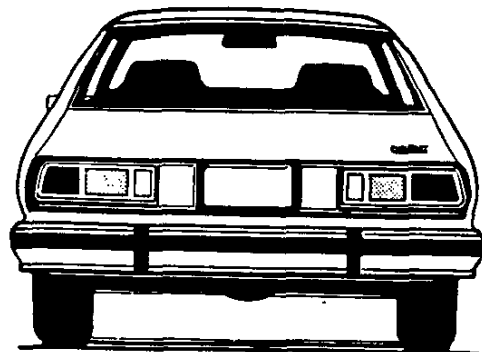
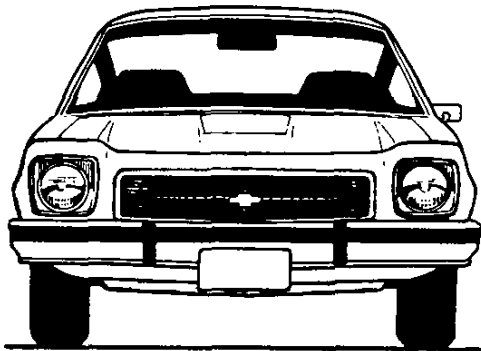

MODEL IDENTIFICATION

COUPE 1HM27

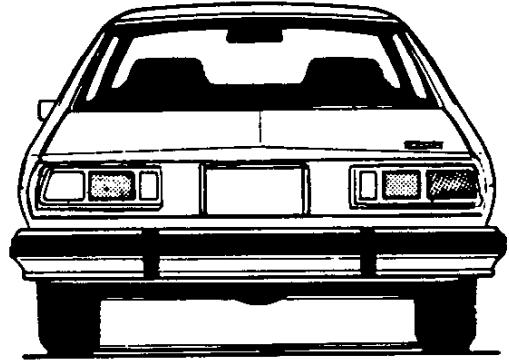
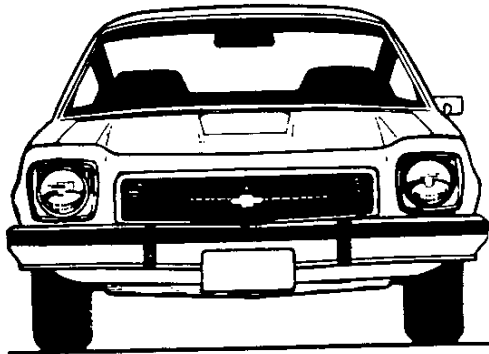
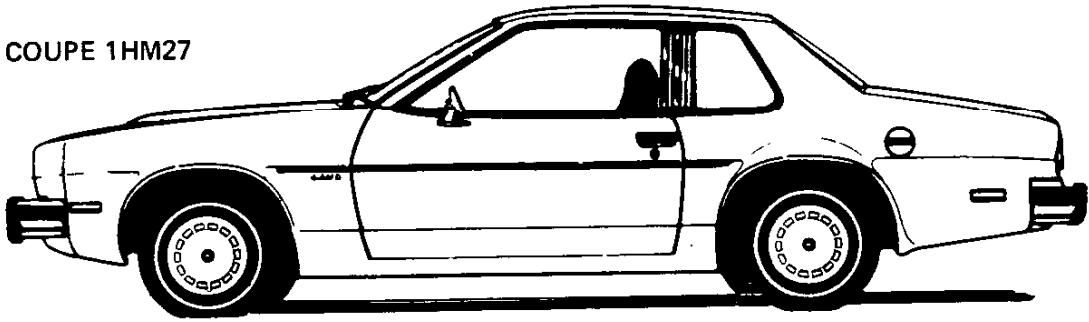

BODY	BODY STYLE	MODEL DESIGNATION	PASSENGERS
H-CAR	2-Door Hatchback Coupe	1HM07	4
	2-Door Notchback Coupe	1HM27	4
	2-Door Hatchback Coupe	1HR07	4

COUPE 1HR07

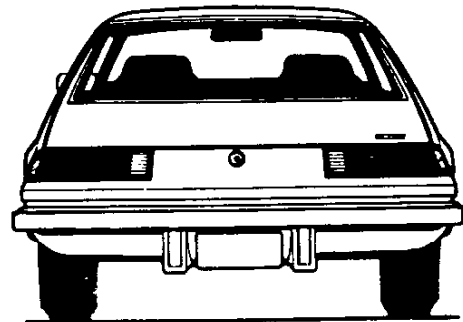
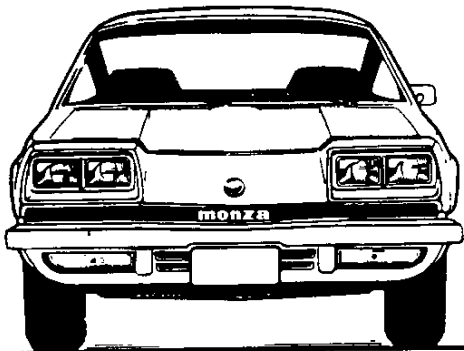
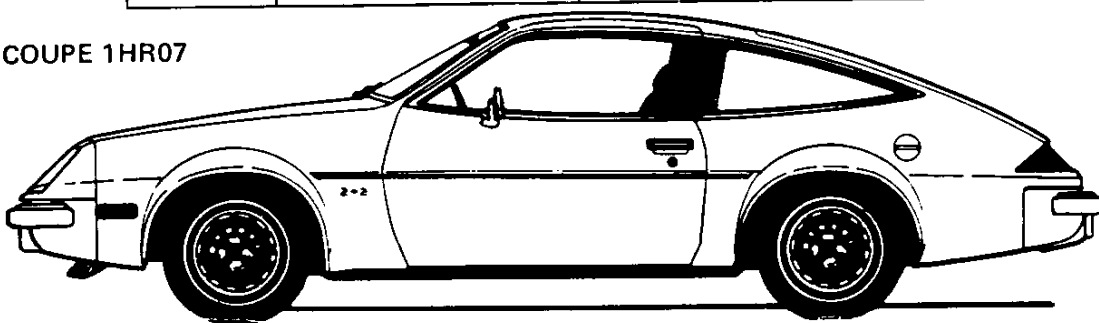

SERIAL NUMBERS AND IDENTIFICATION

ONLY BASIC DESIGNATIONS SHOWN

VEHICLE SERIAL NUMBER

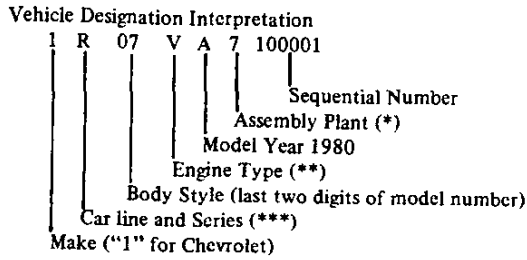

- *7 - Lordstown-GMAD
- **V - L4-151 (86 H.P.) (RPO LX8)
- A - V6-231 (110 H.P.) (RPO LD5)
- ***R - Monza - 1HR07
- M - Monza - 1HM07, 27

EXAMPLE: The twenty-fifth Chevrolet vehicle built at Chevrolet Lordstown if it were a 1HR07 model (Monza Hatchback Coupe) with a L4-151 (86 H.P.) engine would bear VIN Number 1R07VA7100025.

Location Stamped on plate attached to left hand windshield pillar.

TRANSMISSION IDENTIFICATION

Example: R0E01D

Type Designation	Source Designation	Model Year 1980	Production ^o Month & Date
SH	R (Muncie)	0	E01D*

SH	4-Speed	L-4 engine	R - Muncie
7PA	3-Speed Auto.	L-4 engine	B - Parma
SH	4-Speed	V-6 engines	R - Muncie
7KA	3-Speed Auto.	V-6 engines	B - Parma

LOCATION:

- 4-Speed Stamped on the top right side of transmission case.
- 3-Speed Automatic Stamped on right side of transmission, above filler plug.

^o-Month: E denotes May; 01 denotes 1st day.
-Alpha Characters used in identifying the Calendar Month

A - January	D - April	K - July	R - October
B - February	E - May	M - August	S - November
C - March	H - June	P - September	T - December

*-The letter "D" or "N" following the date numerals indicates day or night shift, on automatic only.

ENGINE IDENTIFICATION

Example: T1210WD

Source Designation	Production* Month & Date	Type Designation
T (Tonawanda)	1210	WD

2.5 L, 151 Cubic Inch, L4 Engine (Base Engine) (RPO LX8)
 WD - Regular engine, 4-speed transmission, 2-bbl. carb.
 XD - Regular engine, 3-speed automatic, 2-bbl. carb.

2.5L, 151 Cubic Inch, L4 Engine (RPO LX8)
 (Base Engine California Only)
 A9 - Regular engine, 4-speed transmission, 2-bbl. carb.
 ZA - Regular engine, 3-speed automatic, 2-bbl. carb.

3.8L, 231 Cubic Inch, V-6 Engine (RPO LD5)
 EX - Optional engine, 4-speed transmission, 2-bbl. carb.
 EZ - Optional engine, 3-speed automatic, 2-bbl. carb.

3.8L, 231 Cubic Inch, V-6 Engine (California (RPO LD5)
 EY - Optional engine, 4-speed transmission, 2-bbl. carb.
 OC - Optional engine, 3-speed automatic, 2-bbl. carb.

Location:

- 4-Cylinder engine Stamped opposite the number three cyl. on the right side of case.
- V6-Cylinder engine Stamped on top front of right hand bank of cylinder and case as close as possible to lower end of pad.

*-Month: December, 12; 10th day of December, 10.

REAR AXLE IDENTIFICATION

- 2EB- 2.56 Axle
- 2EC- 2.73 Axle
- 2ED- 2.93 Axle

Location, Identification Number
 Stamped on front of right hand axle tube
 3 to 5 inches outboard of the carrier.

See Power Train Section for additional information.

EXTERIOR EQUIPMENT

EXTERIOR EQUIPMENT

<u>STATUS</u>	<u>APPEARANCE FEATURES</u>	<u>NOTCH.</u> <u>1HM27</u>	<u>HATCH.</u> <u>1HM07</u>	<u>HATCH.</u> <u>1HR07</u>
<u>EXTERIOR</u>				
<u>FRONT</u>				
C/O	Front Header Panel	X	X	-
C/O	Body Color Plastic Slotted Front End Panel . .	-	-	X
C/O	'Monza' Nameplate	-	-	X
C/O	Front Bow-Tie Medallion	-	-	X
NEW	Black Radiator Grille with Bright Periphery . .	X	X	-
NEW	Grille Bow-Tie Emblem	X	X	-
C/O	Body Color Plastic Lower Valance Panel	X	X	-
C/O	Bright Windshield Reveal Moldings	X	X	-
C/O	Bright and Black Windshield Reveal Moldings .	-	-	X
Headlamp Bezels				
C/O	Bright (Quad Rectangular Headlamps)	-	-	X
C/O	Bright (Two Round Headlamps)	X	X	-
C/O	Clear Parking Lamp Lens and Amber Bulb	-	-	X
C/O	Amber Parking Lamp Lens and Clear Bulb	X	X	-
C/O	Brushed Metallic Windshield Wipers	X	X	-
C/O	Black Windshield Wipers	-	-	X
Front Bumper				
C/O	Soft Facia, Integral Body Color Rub Strips and Guards	-	-	X
MOD.	Chrome Face Bar with Bumper Guards and Rub Strips	X	X	-
C/O	Black Front Air Dam	-	-	X

EXTERIOR EQUIPMENT

EXTERIOR EQUIPMENT

STATUS	APPEARANCE FEATURES	NOTCH.	HATCH.	HATCH.
		1HM27	1HM07	1HR07
	SIDE			
	Ornamentation			
C/O	Front Fender 'Monza' Nameplate	X	X	-
C/O	Front Fender '2 + 2' Nameplate	-	-	X
C/O	Body Color Door Handle Insert	-	-	X
	Moldings			
MOD	Body Side With Vinyl Insert	X	X	X
C/O	Bright Door Belt	-	X	X
C/O	Bright Door and Rear Quarter Belt	X	-	-
C/O	Bright Door Frame	-	X	X
C/O	Bright Roof and Rear Quarter Window Drip	X	-	-
C/O	Bright and Black Rear Quarter Window	-	X	X
C/O	Black Rear Quarter Window	X	-	-
C/O	Black Door Window Frame (No Moldings)	X	-	-
C/O	Black Door and Rear Quarter Pillar Applique	-	X	X
C/O	Black Rear Quarter Pillar Applique - Argent Edges	X	-	-
	Wheel Trim			
C/O	Metallic Wheel Covers	X	X	-
C/O	Argent Metallic Finned Plastic Wheel Cover and Center Hub Cap	-	-	X
C/O	Deluxe Color-keyed Wheel Covers	O	O	O
C/O	White Stripe Tires	X	X	X
C/O	Fixed Rear Quarter Window	X	X	X
C/O	Amber Front Fender Marker Lamp	X	X	X
C/O	Red Rear Quarter Marker Lamp	X	X	-
C/O	Rectangular L.H. Outside Rear View Mirror	X	X	X
C/O	L.H. Rear Quarter Gas Cap	X	X	X

O - Optional

EXTERIOR EQUIPMENT

EXTERIOR EQUIPMENT

<u>STATUS</u>	<u>APPEARANCE FEATURES</u>	<u>NOTCH.</u> <u>1HM27</u>	<u>HATCH.</u> <u>1HM07</u>	<u>HATCH.</u> <u>1HR07</u>
	<u>REAR</u>			
C/O	Hatch Lid 'Chevrolet' Nameplate	-	X	X
C/O	Deck Lid 'Chevrolet' Nameplate	X	-	-
C/O	Rear End Panel Key Lock Medallion and Bow Tie Cover	-	-	X
	Moldings			
C/O	Bright Back Window Reveal	X	X	-
C/O	Bright and Black Back Window Reveal . .	-	-	X
C/O	Swing-Up Hatch Lid	-	X	X
	Taillamps			
C/O	Red Wrap-Around Design with Back-Up Lamp and Bright Trim	-	-	X
C/O	Tri-Color Rectangular Design with Back-Up Lamp and Bright Bezel	X	X	-
	Rear Bumper			
C/O	Soft Facia, Integral Body Color Rub Strips and Guards	-	-	X
MOD.	Chrome Face Bar with Bumper Guards and Rub Strips	X	X	-

INTERIOR EQUIPMENT

INTERIOR EQUIPMENT

<u>STATUS</u>	<u>APPEARANCE FEATURES</u>	<u>NOTCH.</u> 1HM27	<u>HATCH.</u> 1HM07	<u>HATCH.</u> 1HR07
	INSTRUMENT PANEL AND STEERING WHEEL			
C/O	Instrument Panel Knobs, Bright Aluminum . . .	X	X	X
C/O	Heater Control Levers, Bright	X	X	X
C/O	2-Speed Electric Windshield Wipers and Washers	X	X	X
C/O	Vent Control Knobs, Cowl Kick Pad - Bright	X	X	X
C/O	Audio and Visual Seat/Shoulder Belt Warning System - Driver's Side Only	X	X	X
MOD.	Instrument Cluster with Tell-Tales (Modified Graphics)	X	X	X
C/O	Instrument Panel 'Monza' Nameplate - R.H. .	X	X	X
C/O	Sport Steering Wheel, Color-keyed Wheel, Shroud and Column	X	X	X
NEW	Steering Column Ignition Lock	X	X	X
C/O	Cigarette Lighter	X	X	X
C/O	Instrument Panel and Cluster, Color-Keyed and Brushed Aluminum Accents	X	X	X
C/O	Instrument Panel R.H. Black Plaque	-	-	X
C/O	Instrument Panel Glove Box, Bright Chrome Door Latch (No Lock)	X	X	X

INTERIOR EQUIPMENT

INTERIOR EQUIPMENT

<u>STATUS</u>	<u>APPEARANCE FEATURES</u>	<u>NOTCH.</u> <u>1HM27</u>	<u>HATCH.</u> <u>1HM07</u>	<u>HATCH.</u> <u>1HR07</u>
<u>INTERIOR</u>				
<u>DOORS AND QUARTER PANELS</u>				
C/O	Molded Soft Door Trim Panel with Bright Molding, and Carpeted Lower	-	-	X
C/O	Form Molded Plastic Door Trim Panel with Integral L.H. Map Pocket and Armrest . . .	X	X	-
C/O	Door Armrests, Integral Bright Door Locking Knobs	-	-	X
C/O	Bright Plastic Door Locking Knobs (At Belt)	X	X	-
C/O	Form Molded Rear Quarter Trim Panel, Integral Armrest and Quarter Pillar	X	X	X
C/O	Rear Quarter Panel Ash Trays	-	-	X
C/O	Bright Remote Door Handles	X	X	X
C/O	Bright Window Regulator Handle, Black Knob	X	X	X
C/O	Bright Aluminum Sill Plates	X	X	X
<u>SEATS AND FLOORS</u>				
C/O	Contoured Front Bucket Seats, (Custom) . . .	O	O	X
C/O	Contoured Front Bucket Seats	X	X	-
C/O	Folding Rear Seat, Carpeted Back	-	X	X
C/O	Painted Metal Rear Seat Linkage	-	X	X
C/O	Passenger Compartment Floor, Carpeted	X	X	X
C/O	Color-keyed Full Floor Console	O	X	X
C/O	Color-keyed Mini-Floor Console with Automatic Trans.	X	-	-
C/O	Floor Mounted Transmission Control Lever with Black Trim Ring	X	X	-
C/O	Bright Parking Brake Lever, Black Plastic Handle	X	X	X
C/O	Parking Brake Cover, Color Keyed	X	X	X
C/O	Front Seat Adjusters L.H. & R.H.	X	X	X
C/O	Front and Rear Seat Back Locks, Black	X	X	X
C/O	Spare Tire Cover, Fiberboard	X	-	-
C/O	Load Compartment Floor Carpeted	-	X	X
C/O	Trunk Mat	X	-	-
NEW	Color-Keyed Front Seat & Shoulder Belts	X	X	X
NEW	Color-Keyed Rear Seat Belts	X	X	X

O - Optional

INTERIOR-EXTERIOR EQUIPMENT

INTERIOR AND EXTERIOR EQUIPMENT

<u>STATUS</u>	<u>APPEARANCE FEATURES</u>	<u>NOTCH.</u> 1HM27	<u>HATCH.</u> 1HM07	<u>HATCH.</u> 1HR07
<u>ROOF AND PILLARS</u>				
C/O	Alpine Cloth Covered .250 Thick Foam			
	Headlining	X	X	X
C/O	Windshield Pillar and Garnish Moldings, Colored Plastic	X	X	X
C/O	Side and Rear Quarter Window Moldings, Colored Plastic	X	X	X
C/O	Rear Window Moldings, Colored Plastic	X	X	X
C/O	Dual Vinyl Sunshades	X	X	X
NEW	Day/Night Inside Rear View Mirror, Windshield Mounted	X	X	X
C/O	Roof Shoulder Harness Retractor Covers, Colored Plastic	X	X	X
C/O	Center Dome Lamp	X	X	X
C/O	Front Door Jamb Switch, L.H.	X	X	X
C/O	Front Door Jamb Switch R.H.	*	*	X
<u>FUNCTIONAL FEATURES</u>				
C/O	Body Acoustical Package	X	X	X
C/O	Front Stabilizer (1-1/16")	O	O	X
C/O	Rear Stabilizer	O	O	O
C/O	Tires, A78-13B Bias Ply White Stripe (QAG)	X	X	X
C/O	13 x 5 Wheels	X	X	-
C/O	13 x 6 Wheels	-	-	X
C/O	AM Radio	X	X	X
C/O	Tinted Glass	X	X	X

* - Included with RPO B18 or TR9

O - Optional

EXTRA COST EQUIPMENT

EQUIPMENT	RPO	ACC
MODEL OPTIONS		
Spyder Option (see page 12 for content)	Z29	
Deluxe Interior Option (see page 13 for content)	B18	
Exterior Decor Package (see page 13 for content)	ZM5	
POWER TEAMS		
Axle Rear, Limited Slip Differential	G80	
Axle Rear, Performance Ratio	G92	
Engine, L4 - 2.5 Liter (151 CID)	LX8	
Engine, V6-3.8 Liter (231 CID)	LD5	
Transmission, 3-Speed Automatic	MX1	
POWER ASSISTS		
Brakes, Power	J50	
Steering, Power	N41	
FACTORY INSTALLED OPTIONAL TIRES		
BR70 x 13C Radial Ply Blackwall Tire	QKX	
BR70 x 13C Radial Ply White Stripe Tire	QKY	
BR70 x 13C Radial Ply White Lettered Tire	QKZ	
B78 x 13B Bias Ply White Stripe Tire	QLJ	

EXTRA COST EQUIPMENT

EQUIPMENT	RPO	ACC
OTHER OPTIONS		
Air Conditioner, All Weather (See page 14 for content)	C60	
Alarm, Auto Theft		ACC
Antenna, Radio - Rod and Mast		ACC
Battery, Heavy Duty 'Freedom'	UA1	
Clock Electric	U35	ACC
Compass, Auto		ACC
Console, Floor Mounted (1HM27 Only)	D55	
Container, Tissue/Litter (4-Colors: Black, Beige, Dk. Blue, Dk. Green)		ACC
Defogger, Rear Window Electric	C49	
Gauges, Instrument Panel	U14	
Glass, Tinted Body	A01	
Guards, Door Edge	B93	ACC
Harness, Rear Seat Shoulder		ACC
Hitch, Trailer		ACC
Intermittent Windshield Wiper System	CD4	
Lighting, Auxiliary	TR9	
Engine Compartment Lamp (RPO U26)		
Glove Box Lamp (RPO U27)		
Headlamp On Buzzer (RPO T63)		
R.H. Front Door Jamb Switch (RPO C80) (1HM00)		
Lamp, Portable Spot		ACC
Mats, Floor, Front and Rear (Color Keyed)	B37	ACC
Mats, Front and Rear Floor		ACC
Mirrors, Dual Sport, L.H. Remote, R.H. Manual	D35	
Moldings, Body Side Protective (Vinyl insert)	B84	ACC
Moldings, Vinyl Body Side (Adhesive Back)		ACC
Radiator, Heavy Duty	V01	
Radio, AM-FM Stereo	U58	
Radio, AM with Stereo Tape System	UM1	
Radio, AM/FM with Stereo Tape System	UM2	
Radio AM/FM Stereo with Cassette Tape Player	UN3	
Radio AM/FM Stereo with Digital Clock	UY8	
Radio, AM-FM	U69	ACC
Speaker, Auxiliary (Requires U63 or U69)	U80	ACC
Sport Stripes	DX5	
Sport Suspension	F41	
Steering, Comfort Tilt	N33	
Warmer, Car Interior		ACC

RPO Z29

SPYDER EQUIPMENT, RPO Z29

AVAILABILITY

Monza Sport 2 + 2 (1HR07)

CONTENT (In addition to or in place of standard equipment)

EXTERIOR

FRONT

- NEW + Black Headlamp Bezels
- + Front Air Dam, Body Colored (New Ends) (D80)
- *+ Black Windshield Reveal Moldings
- NEW + 'Spyder' Hood Decal
- + 'Spyder' Front Facia Emblem
- NEW + Black Front Bumper Rub Strips (Body Color Guards)

SIDE

- *+ Black Door, Quarter Window, and Belt Moldings
- *+ Black Painted Lower Fender, Rocker and Quarter Panel (Below door bottom line, wheel opening to wheel opening)
- + Black Rally II Wheels (N98) with Bright Trim Rings (P06)
- + Sport Mirrors, Black Painted (D35)
- NEW + Body Side Stripes with 'Spyder' Outlined in Accent Color
- Delete '2+2' Front Fender Nameplate
- NEW - Delete V6 Front Fender Nameplate

REAR

- NEW + Black Taillamp Bezels
- + Black Paint Under Taillamp Openings
- *+ Black Rear Window Reveal Moldings
- + Spoiler, Body Color (D80)
- NEW + Spoiler Stripes with Spyder Outlined in Accent Color
- NEW + Rear End Panel Stripe (Above Rub Strip)
- + 'Spyder' Emblem on Lock Cover
- NEW + Black Rear Bumper Rub Strips (Guards Remain Body Color)
- Delete Hatchlid 'Chevrolet' Nameplate

INTERIOR

- + 'Spyder' Horn Button Cap

FUNCTIONAL

- + Sport Suspension (F41)
- + BR 70 x 13 BW Steel Belted Radial Tires
- + 1-1/8" Dia. Front Stabilizer Replaces 1-1/16" Dia. with V-6 Engine Only

* Not used when Black exterior paint is specified.

DELUXE INTERIOR RPO B18

AVAILABILITY

1HM00

CONTENT (In addition to or in place of standard equipment)

	<u>07</u>	<u>27</u>
+ R00 Front and Rear Seats with Deluxe Cloth or Vinyl Seat Trim (YR1-YS1)	X	X
+ R00 Soft Door Trim Panel with Carpeted Lower and Bright Molding (No LH Map Pocket)	X	X
+ Armrest with Integral Bright Door Lock Buttons	X	X
+ Rear Quarter Trim Panel Ash Trays (YT1)	X	X
+ R.H. Door Jamb Switch (C80)	X	X
+ R00 Instrument Panel RH Black Plaque	X	X

EXTERIOR DECOR PACKAGE RPO ZM5

AVAILABILITY

1HM27

CONTENT (In addition to or in place of standard equipment)

- + Bright Window Reveal Moldings (B90)
- + Wheel Opening Moldings (B96)
- + Deluxe Wheel Covers (Color-Keyed) (PA3)
- + Deck Lid Luggage Carrier (V55)

AIR CONDITIONING

FOUR SEASON (RPO C60)

Integral air cooling and heater system. Manually controlled by two horizontal levers on instrument control panel, plus 4-speed fan switch. Upper lever operates compressor and air selector doors; lower lever controls air temperature from instrument panel and side outlets.

BASIC COMPONENTS

Control panel, evaporator, blower, condenser, receiver-dehydrator, refrigerant (freon) tank, air intake assembly and duct assembly for both systems.

EQUIPMENT (Used in addition to or in place of base equipment)

CHASSIS

Rear Axle Ratio -- Refer to Power Trains Section

POWER TRAINS

Fan	7 blade w/LX8; 5 blade w/LD5
Crankshaft Pulley	Single two groove pulley
Compressor & Crankshaft Belt	One
Generator	L4 & V6 engines 55 ampere
Radiator	Heavier duty

DIMENSIONS AND WEIGHTS

INTERIOR DIMENSIONS	2
EXTERIOR DIMENSIONS	3 & 4
LUGGAGE CAPACITY	5
HATCHBACK COUPE CARGO SPACE	5
VEHICLE WEIGHTS	6
OPTIONAL EQUIPMENT WEIGHTS	6

INTERIOR DIMENSIONS

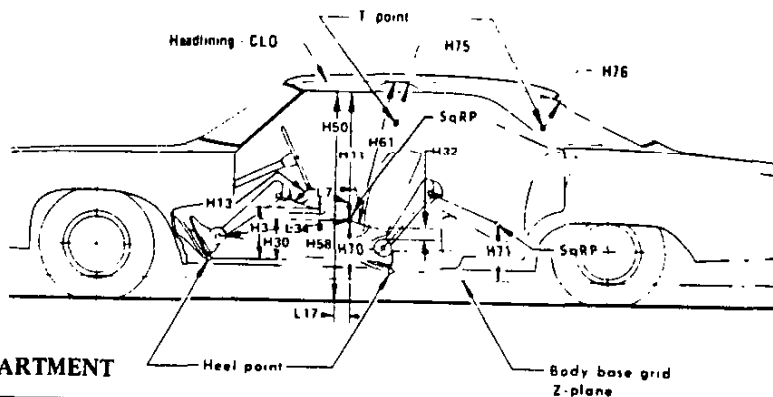

FRONT COMPARTMENT

CODE	DESCRIPTION	2-DOOR HATCHBACK COUPES		2-DOOR NOTCHBACK COUPE
		1HM07	1HR07	1HM27
H-3	Seat cushion height		251 (9.9)	
H11	Entrance height	757 (29.8)		747 (29.4)
H13	Steering wheel to centerline of thigh		96 (3.8)	
H30	SgRP to heel point (chair height)		185 (7.3)	
H32	Seat cushion deflection		79 (3.1)	
H50	Upper body opening to ground	1161 (45.7)		1151 (45.3)
H58	H point rise - Design		28 (1.1)	
H61	Effective headroom	950 (37.4)		945 (37.2)
H70	SgRP to body base grid		277 (10.9)	
H75	Effective "T" point headroom	952 (37.5)		947 (37.3)
W3	Shoulder room		1313 (51.7)	
W5	Hip room		1234 (48.6)	
L7	Steering wheel torso clearance		366 (14.4)	
L17	H point travel - Design		165 (6.5)	
L34	Effective leg room		1095 (43.1)	

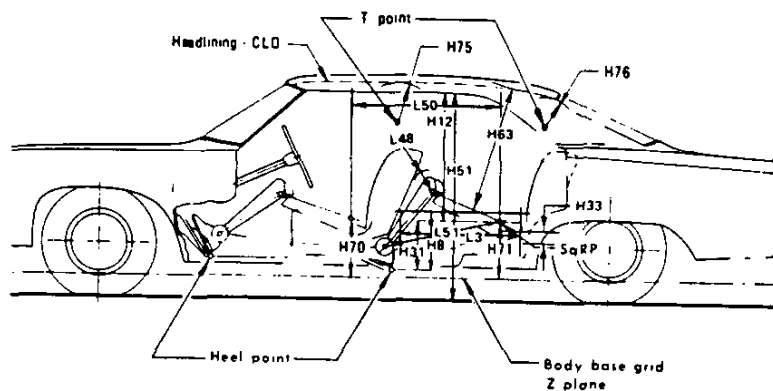

REAR COMPARTMENT

H8	Seat cushion height	231 (9.1)		244 (9.6)
H12	Entrance height		--	
H31	SgRP to heel point (chair height)	213 (8.4)		226 (8.9)
H33	Seat cushion deflection	74 (2.9)		109 (4.3)
H51	Upper body opening to ground		--	
H63	Effective headroom	897 (35.3)		937 (36.9)
H71	SgRP to body base grid	239 (9.4)		251 (9.9)
H76	Effective "T" point headroom	907 (35.7)		930 (36.6)
W4	Shoulder room	1318 (51.9)		1288 (50.7)
W6	Hip room		1067 (42.0)	
L3	Rear compartment room	612 (24.1)		627 (24.7)
L48	Knee clearance	-58 (-2.3)		-69 (-2.7)
L50	SgRP couple distance	693 (27.3)		686 (27.0)
L51	Effective leg room	747 (29.4)		742 (29.2)

* Primary Dimensions are millimeters unless otherwise shown.

EXTERIOR DIMENSIONS

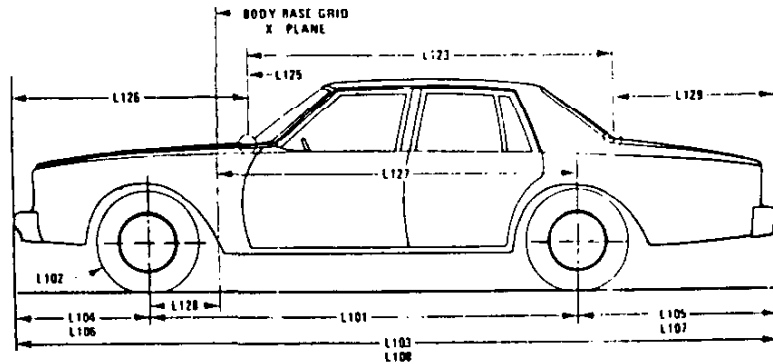

LENGTHS

CODE	DESCRIPTION	2-DOOR HATCHBACK COUPES		2-DOOR NOTCHBACK COUPE
		1HM07	1HR07	1HM27
L101	Wheelbase	2464 (97.0)		
L102	Tire size (standard)	A78-13B		
L103	Overall length	4569 (179.9)	4554 (179.3)	4569 (179.9)
L104	Overhang, front	940 (37.0)	935 (36.8)	940 (37.0)
L105	Overhang, rear	1166 (45.9)	1156 (45.5)	1166 (45.9)
--	Overall length - less bumpers	4348 (171.2)	4450 (175.2)	4348 (171.2)
L123	Body upper structure length at car centerline	2563 (100.9)		2215 (87.2)
L125	Body base grid plane to windshield cowl point	278 (10.9)		
L126	Front end length at centerline	1471 (57.9)		
L127	Rear wheel centerline to body base grid line	2184 (86.0)		
L128	Front wheel centerline to body base grid line	279 (11.0)		
L129	Rear end length at centerline	343 (13.5)	752 (29.6)	
L130	Front of dash to body base grid	- 20 (-0.8)		

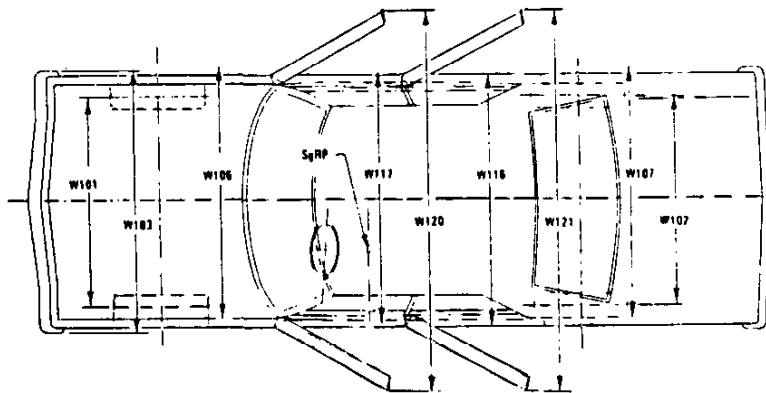

WIDTHS

W101	Tread - front	1392 (54.8)	
W102	Tread - rear	1361 (53.6)	
W103	Maximum overall width of car	1661 (65.4)	
W106	Front fender overall width	1661 (65.4)	
W107	Rear fender overall width	1659 (65.3)	
W116	Maximum overall width of body	1661 (65.4)	
W117	Body width at SgRP - front	1643 (64.7)	
W120	Overall car width, front doors open	3820 (150.4)	3759 (148.0)
W121	Overall car width, rear doors open	--	

*Primary Dimensions are millimeters unless otherwise shown.

EXTERIOR DIMENSIONS

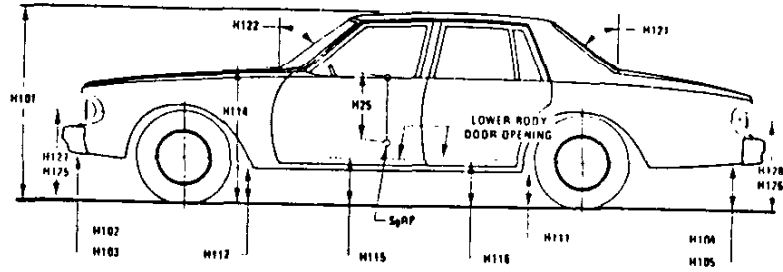

HEIGHTS

CODE	DESCRIPTION	2-DOOR HATCHBACK COUPES		2-DOOR NOTCHBACK COUPE
		1HM07	1HR07	1HM27
H101	Overall height (design)	1275 (50.2)		1272 (50.1)
H102	Front bumper to ground	259 (10.2)	183 (7.2)	259 (10.2)
H104	Rear bumper to ground	333 (13.1)		
H111	Rocker panel to ground - rear	157 (6.2)		
H112	Rocker panel to ground - front	168 (6.6)		
H114	Hood at rear to ground	891 (35.1)		
H115	Step height - front (design)	289 (11.4)		
H125	Headlamp to ground	630 (24.8)	663 (26.1)	630 (24.8)
H126	Tail lamp to ground	610 (24.0)	665 (26.2)	625 (24.6)
H136	Body O line to ground - front	127 (5.0)		
H137	Body O line to ground - rear	122 (4.8)		

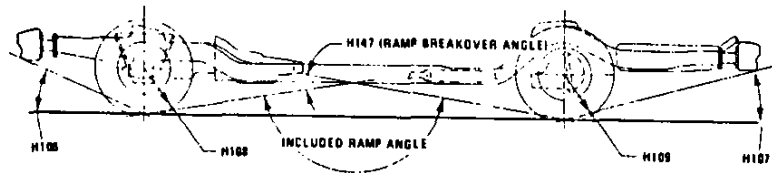
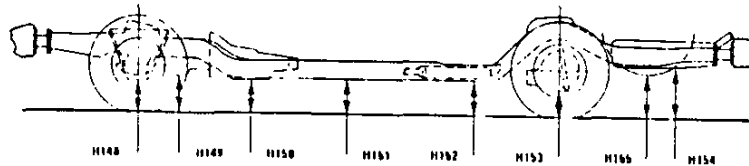

CLEARANCES

H106	Angle of approach (degrees)	23.13°	20.99°	23.13°
H107	Angle of departure (degrees)	17.81°	15.74°	17.81°
H147	Ramp breakover angle (degrees)	12.03°		
H148	Front suspension to ground	152 (6.0)		
H149	Oil pan to ground	142 (5.6)		
H150	Flywheel housing to ground	137 (5.4)		
H151	Frame to ground	165 (6.5)		
H152	Exhaust system to ground	112 (4.4)		
H153	Rear axle to ground	132 (5.2)		
H154	Fuel tank to ground	234 (9.2)		
H156	Minimum ground clearance	112 (4.4) (a)		

(a) Exhaust pipe @ crossover.

* Primary Dimensions are millimeters unless otherwise shown.

INTERIOR DIMENSIONS

LUGGAGE COMPARTMENT

CODE	DESCRIPTION	2-DOOR HATCHBACK COUPES		2-DOOR NOTCHBACK COUPE
		1HM07	1HR07	1HM27
H195	Liftover height	732 (28.8)		579 (22.8)
V1	Usable luggage capacity, liter (cu. ft.)	--		187 (6.6)

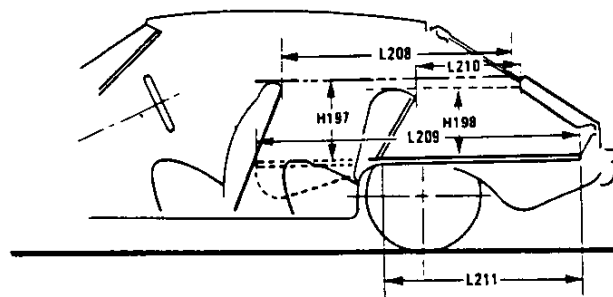

HATCHBACK CARGO SPACE

W4	Shoulder room - rear	1318 (51.9)
H197	Front seat back to load floor height	465 (18.3)
L208	Cargo length at - front seat back height	1029 (40.5)
L209	Cargo length at floor - front	1572 (61.9)
V3	Total hatchback - cargo index volume liter (cu. ft.)	787 (27.8)

* Primary Dimensions are millimeters unless otherwise shown.

VEHICLE WEIGHTS

MONZA

MODEL SYMBOL	VEHICLE TYPE Description	SHIPPING WEIGHT			CURB WEIGHT		
		Front	Rear	Total	Front	Rear	Total
1HM27	2-Dr. Notchback (Coupe)	657.7 (1450)	529.4 (1167)	1187.1 (2617)	654.7 (1443)	575.4 (1269)	1230.1 (2712)
1HM07	2-Dr. Hatchback (Coupe)	671.5 (1480)	540.6 (1192)	1212.1 (2672)	661.5 (1458)	593.6 (1309)	1255.1 (2767)
1HR07	2-Dr. Hatchback (Coupe)	685.9 (1512)	552.2 (1217)	1238.1 (2729)	675.9 (1490)	605.2 (1334)	1281.1 (2824)

SHIPPING WEIGHT: Weight of basic vehicle with regular equipment, including grease, oil and (3) gallons of gasoline, and engine coolant to capacity.

CURB WEIGHT: Shipping weight plus gasoline to capacity.

For total shipping, and curb, weights of vehicles equipped with the following options, add to, or deduct from, the base vehicle weight (pounds).

OPTIONAL EQUIPMENT

RPO	OPTION	WITH	WEIGHT METRIC (kg) - ENGLISH
B18	Deluxe Interior	1HM00	0.9 (2 lb.)
B37	Floor Mats, Front & Rear		3.2 (7 lb.)
C60	Air Conditioning	Used with L4 Engine, RPO LX8 Used with V6 Engine, RPO LD5	28.6 (63 lb.)
D35	Dual Sport Mirrors, Outside Rearview		1.4 (3 lb.)
D55	Front Compartment Floor Console	1HM27	2.7 (6 lb.)
F41	Sport Suspension Front & Rear		4.1 (9 lb.)
J50	Power Brakes		4.1 (9 lb.)
N33	Tilt Steering Wheel		1.8 (4 lb.)
N41	Power Steering		14.5 (32 lb.)
UA1	Heavy Duty Battery	With LX8 Engine With LD5 Engine	2.3 (5 lb.) 4.5 (10 lb.)
UM1	Radio AM Stereo	With Tape System & 2 speakers	1.4 (3 lb.)
UM2	Radio AM/FM Stereo	With Tape System & 2 speakers	1.8 (4 lb.)
UN3	Radio AM/FM Stereo with Cassette Player	With Cassette Tape & 2 speakers	1.4 (3 lb.)
UY8	Radio AM/FM Stereo With Clock & Digital Display	With 2 speakers	1.4 (3 lb.)
U58	Radio AM/FM Stereo	With 2 speakers	1.4 (3 lb.)
U69	Radio AM/FM Pushbutton		0.5 (1 lb.)
U80	Auxiliary Speaker		0.9 (2 lb.)
V01	Heavy Duty Radiator		1.4 (3 lb.)
N98	Rally II Wheels		0.5 (1 lb.)
PA3	Deluxe Wheel Covers (Color-keyed)		2.7 (6 lb.)
ZM5	Exterior Decor Package	1HM27	8.6 (19 lb.)
Z29	"Spyder" Equipment	1HR07 with LX8 Engine 1HR07 with LD5 Engine	4.1 (9 lb.) 7.3 (16 lb.)
LD5	3.8 Liter V6, 231 CID Engine	With 1HR00 Models With 1HM00 Models	50.8 (112 lb.) 51.7 (114 lb.)
M29	3-Speed Automatic Transmission	Used with LX8 Engine	-9.5 (-21 lb.)
M38	3-Speed Automatic Transmission	Used with LD5 Engine	6.8 (+15 lb.)

*Primary mass weights are in kilograms (pounds).

BODY

EXTERIOR PAINT PROCESS	2
EXTERIOR COLORS AND VINYL ROOF COMBINATIONS	3
EXTERIOR-INTERIOR COLORS	4
EXTERIOR-INTERIOR COLORS MONZA 1HR07 "SPYDER" RPO Z29	5
MONZA "SPYDER" PACKAGE COLORS SIDE STRIPE, HOOD-SPYDER DESIGN AND SPOILER LETTERING	5
MONZA SPORT STRIPE PACKAGE RPO DX5	6
BODY CONSTRUCTION AND GLASS AREA	7

ELPO PAINT PROCESS

Major advances in the painting process of Monza bodies contribute significantly to elimination of rust and corrosion. This technique, called "Elpo", primes sheet metal and bodies by electricity. Technically the name is "Electrophoretic Deposition of Polymers". It applies a smooth, even, and continuous prime coat to the entire body and sheet metal including hidden inner surfaces.

Elpo deposits prime coat to all surfaces by submerging them into a large tank filled with a solution composed of paint particles suspended in water. The paint primer particles are given an electrical charge and the body is submerged, charged primer particles are attracted to the metal surfaces through a principle known as "Electrophoresis".

A seven-stage zinc phosphate rustproofing process is given the body before it reaches the Elpo installation. A conveyor then transports the parts downward into a tank for the primer coating. Parts are submerged for about two minutes and upon emerging go through a rocking movement to carry away excess liquid.

The electro-coating process causes even the most remote inner surfaces to be coated with primer, and all edges and complex shapes coated with the same thickness as exposed flat surfaces.

The new primer paint system replaces the spray gun and paint booth priming operations.

Subsequent stages of the paint process include application of a primer-surfacer baking, wet sanding and sealer coating, ending with a topcoat of long lasting acrylic lacquer and enamel which is baked in an oven at 300 degrees.

EXTERIOR-INTERIOR COLORS

EXTERIOR COLOR – VINYL ROOF COMBINATIONS (1HM27)

EXTERIOR COLOR	CODE	FISHER W.A.	VINYL ROOF COLORS						
			11T C/O WHITE	19T C/O BLACK	21T LT. BLUE	44T DK. GREEN	63T LT. CAMEL	76T DK. CLARET	85T GRAY
White	11	3967							
Silver Met.	15	7022							
Black	19	848							
Lt. Blue Met.	21	7102							
Dk. Blue Met.	29	7103							
Dk. Green Met.	44	7105							
Yellow	50	7100							
Beige	59	7084							
Lt. Camel Met.	63	7136							
Med. Camel Met.	69	7137							
Red	72	4998							
Dk. Claret Met.	76	7112							
Cinnabar	77	7104							
Gray	85	7101							

EXTERIOR-INTERIOR COLORS

EXTERIOR-INTERIOR COLOR COMBINATIONS

EXTERIOR COLOR	CODE	INTERIOR TRIM				
		BLACK	BLUE	CAMEL	CARMINE	OYSTER
White C/O	11	X	X	X	X	X
Silver Met. C/O	15	X	X		X	X
Dk. Claret Met.	76			X	X	
Dk. Blue Met.	29		X	X	X	
Black C/O	19	X	X	X	X	X
Lt. Blue Met.	21		X			
Beige	59	X	X	X	X	
Dk. Green Met.	44			X		
Gray	85	X	X		X	X
Yellow	50	X	X	X		X
Lt. Camel Met.	63			X		
Med. Camel Met.	69			X		
Cinnabar	77	X		X		X
Red	72	X			X	X

MODEL	Seat Type	INTERIOR TRIM								
		Black		Dark Blue		Camel Tan		Carmine		Oyster
		Cloth	Vinyl	Cloth	Vinyl	Cloth	Vinyl	Cloth	Vinyl	Vinyl
Monza - 1HM00										
Hatchback (07)	(A51) Bucket	19G	19Y		26Y	62G	62Y		74Y	
Notchback (27)	(A51) Bucket	19C	19N		26N	62C	62N		74N	
Monza Deluxe Interior †										
1HR07, 1HM00 with B18										
Hatchback (07)	(A51) Bucket		19V	26J	26V	62J	62V	74J	74V	12V
Notchback (1HM27 with B18 only)	(A51) Bucket		19V	26J	26V	62J	62V	74J	74V	12V

CLOTH AND VINYL USAGE

B, C & G - Sparta, trilaminate knit cloth
 N, R & Y - Oxen, vinyl
 W & V - Rattan vinyl; Sierra bolster
 D & J - Pompey, woven cloth, Dover bolster

† - The Monza Custom Interior is standard on the 1HR07 and is an available option (RPO B18) on the 1HM07-27.

EXTERIOR-INTERIOR COLORS

1HR07 "SPYDER" (RPO Z29) EXTERIOR-INTERIOR COLOR COMBINATIONS

EXTERIOR COLOR		INTERIOR TRIM				
		Black	Dark Blue	Camel Tan	Carminc	Oyster
		DECOR PACKAGE COLOR				
WHITE	11	Black	Blue	Gold	Red	Silver
SILVER MET.	15	Black	Blue	—	Red	Silver
BLACK	19	Silver	Blue	Gold	Red	Silver
LT. BLUE MET.	21	Blue	Blue	—	—	Silver
DK. BLUE MET.	29	Blue	Blue	Gold	Blue	Silver
DK. GREEN MET.	44	Gold	—	Gold	—	Silver
YELLOW	50	Black	—	Gold	—	Silver
BEIGE	59	Black	Gold	Gold	Red	—
LT. CAMEL MET.	63	Gold	—	Gold	—	—
MED. CAMEL MET.	69	Gold	—	Gold	Gold	Gold
RED	72	Black	—	Gold	Red	Red
DK. CLARET MET.	76	Gold	—	Gold	Red	Silver
CINNABAR	77	Black	—	Gold	—	Black
GRAY	85	Black	Blue	Gold	Red	Silver

PACKAGE COLOR RPO IDENTIFICATION

RPO	SIDE & SPOILER STRIPES	HOOD-SPYDER DESIGN
SILVER (14A)	Dk. Silver with Silver Lettering and Black Accents	SPYDER BODY—Clear SPYDER OUTLINE—Dk. Silver ACCENT BORDER—Silver WEB/STRIPE—Black
BLACK (18A)	Black with Red Lettering and Yel. Orange Accents	SPYDER BODY—Clear SPYDER OUTLINE—Red ACCENT BORDER—Yellow Orange WEB/STRIPE—Black
BLUE (26A)	Med. Blue with Lt. Blue Lettering and Dk. Blue Accents	SPYDER BODY—Clear SPYDER OUTLINE—Med. Blue ACCENT BORDER—Lt. Blue WEB/STRIPE—Dk. Blue
GOLD (54A)	Dk. Gold with Gold Lettering and Black Accents	SPYDER BODY—Clear SPYDER OUTLINE—Dk. Gold ACCENT BORDER—Gold WEB/STRIPE—Black
RED (78A)	Dk. Red with Red Lettering and Orange Accents	SPYDER BODY—Clear SPYDER OUTLINE—Red ACCENT BORDER—Orange WEB/STRIPE—Dk. Red

COLOR IDENTIFICATIONS

Black	WMH 848	Silver	WMH 7184	Orange	WMH 8206
Red	WMH 4409	Dk. Gold	WMH 8168	Dk. Blue	WMH 7230
Yel. Orange	WMH 8108	Gold	WMH 7083	Med. Blue	WMH 7187
Dk. Silver	WMH 7054	Dk. Red	WMH 7221	Lt. Blue	WMH 7229

EXTERIOR-INTERIOR COLORS

SPORT STRIPE PACKAGE (RPO DX5)

EXTERIOR COLOR		INTERIOR TRIM				
		Black	Dark Blue	Camel Tan	Carmine	Oyster
		STRIPE COLOR				
White	11	Black	Blue	Gold	Red	Silver
Silver Met.	15	Black	Blue	-	Red	Silver
Black	19	Silver	Blue	Gold	Red	Silver
Lt. Blue Met.	21	Blue	Blue	-	-	Silver
Dk. Blue Met.	29	Silver	Blue	Gold	Red	Silver
Dk. Green Met.	44	Gold	-	Gold	-	Silver
Yellow	50	Black	-	Gold	-	Silver
Beige	59	Black	Gold	Gold	Red	-
Lt. Camel Met.	63	Gold	-	Gold	-	-
Med. Camel Met.	69	Gold	-	Gold	Gold	Gold
Red	72	Black	-	Gold	Red	Red
Dk. Claret Met.	76	Gold	-	Gold	Red	Silver
Cinnabar	77	Black	-	Gold	-	Silver
Gray	85	Black	Blue	Gold	Red	Silver

NOTE: NO COLOR OVERRIDES ARE ALLOWED!

STRIPE PACKAGE COLOR IDENTIFICATIONS

		INSERT COLOR		BORDER COLOR	
14A	Silver	Dk. Silver	WMH 7054	Silver	WMH 7184
18A	Black	Black	WMH 848	Red	WMH 4409
26A	Blue	Blue	WMH 7187	Lt. Blue	WMH 7229
54A	Gold	Dk. Gold	WMH 8168	Gold	WMH 7083
78A	Red	Dk. Red	WMH 7221	Red	WMH 4409

BODY CONSTRUCTION AND GLASS AREA

GENERAL

Construction Body-frame integral, using large individual body panels welded together forming complete sub-assemblies. All major sub-assemblies are double panel construction except underbody and rear end panel. The full roof panel subassembly is formed to provide front and rear headers and side rails. Exterior front end sheet metal panels are removable with bolt on fenders. Main front end structure is welded to body proper and forms the base for attachment of engine, front suspension, steering and front end sheet metal. The flush-dry rocker panel system, plastic valance inner fender panels and the Elpo paint process provide corrosion protection to the entire body.

DOORS

Type Double panel construction, hinged at front. Side guard beams. Standard spring loaded hold-open feature with two position detent. Welded-on strap type hinges.
 Handles Flush lift bars
 Glass Full, curved ventless

HOOD AND TRUNK LID

Type Double panel construction, rear hinged, pop-up springs over-center, prop rod holds hood open for engine compartment access, on trunk lid telescoping gas springs.
 Release External, lever located under hood lock assembly.

VENTILATION

High Level Air Intake for Passenger Compartment Double wall plenum chamber, providing washing and air drying of rocker panels for corrosion resistance.
 High Level Power Ventilation Passenger compartment air is obtained by outside air taken in the cowl, top louvers. The air is then routed through the plenum and channeled through side vents in the kick panels. Air flow is circulated into the rear compartment back, down and up through body center pillar channel. The air is then exhausted at the louvered upper portion of the channeled pillar.

SEATS

Type Bucket seats, high back, built-in head restraints, full foam construction, folding second seat standard equipment, not available with 1HM27.
 Belts Three-point seat belt and shoulder harness system.

WINDSHIELD WIPERS AND WASHERS

Type Dual 2-speed electric with 16" blades
 Linkage Parallel acting
 Washer System Electric, dual spray

HEADLIGHTS

Type Single, oval on 1HM27, 1HM07 models. Dual rectangular on 1HR07 model, headlamps mounted in soft plastic front end panel.

SPARE TIRE MOUNT

Location
 Base space saver tire Stored in right rear quarter panel well with a carpeted tire cover.

BODY GLASS VISIBILITY AREA ☉

	1HM07 & 1HR07	1HM27	
Windshield		7934.8 (1229.9)	
Front Door	7203.9 (1116.6)	6907.7 (1070.7)	
Rear Quarter	2870.3 (444.9)	Base 2479.3 (384.3)	Formal 1385.8 (214.8)
Rear Window	8786.4 (1361.9)	5165.2 (800.6)	
Total Area (Sq. In.)	26795.4 (4153.3)	Base 22487.0 (3485.5)	Formal 21393.5 (3316.0)

Windshield Curved thin laminated plate
 Sides and Rear Curved tempered safety plate
 Rear Quarter Windows Curved tempered safety plate (stationary)

☉ Primary dimensions cm²(secondary dimensions in.²)



CHASSIS

FRAME AND FRONT SUSPENSION	2
STEERING, DRIVELINE, WHEELS AND TIRES	3
REAR AXLE AND SUSPENSION	4
BRAKES	5
BULBS AND LAMPS	6
FUSES AND CIRCUIT BREAKERS	7

FRONT SUSPENSION

FRAME

Description Body-frame integral

FRONT SUSPENSION

Description Independent, SLA type, coil springs with center mounted shock absorbers, spherical joint steering knuckle.

Wheel Travel (design)

Total 5.44
 Jounce 1.94
 Rebound 3.50
 Wheel to spring travel ratio 1.977

CONTROL ARMS

Description Reinforced steel stamping with pre-loaded steel encased rubber bushings at pivot.

STEERING KNUCKLES

Description Cast nodular iron with pressed-in spindle, integral brake caliper mounting pads and integral steering knuckle arm.

Spindle Diameters

Inner bearing 1.25
 Outer bearing 0.6875

Spindle Thread Size 11/16-20 NEF-3 (modified)

Wheel Bearings

Type, inner & outer Taper roller

SPHERICAL JOINTS

Type Ball stud
 Upper Compression
 Lower Tension
 Bearing Surfaces
 Upper & Lower Sintered iron

SHOCK ABSORBERS

Type Direct, double acting, hydraulic
 Piston Diameter 1.00

FRONT WHEEL ALIGNMENT (Design)

Caster (degrees) -0.8 ± 0.5
 Camber (degrees) $+0.2 \pm 0.5$
 Toe-In (degrees) -0.06 ± 0.06
 Steering axis inclination $8.55 @ 25^\circ$ camber

STABILIZER BAR - Std. on 1HR00 Models

Type Link
 Material HR steel
 Diameter - Standard 1.06
 RPO Z29 (V-6) 'Spyder' option 1.125
 Bushing Material Rubber

GENERAL SUSPENSION PROVISIONS

Anti-dive control Angle of front upper control arm

FRONT SPRINGS

Selected from a family of springs by Electronic Data Processing which identifies the correct springs for the weight of the vehicle including optional equipment ordered by the customer.

FRONT SPRING SPECIFICATIONS

Engine Application	Part Number	Assy. Code	Cut-Off Length	Wire Dia.	Total Coils	Deflection Rate (lbs./inch)	HEIGHTS	
							Free	Working (In. @ Lbs.)
L-4	354135	AOJ	98.58	.562	7.61	325	12.915	8.70 @ 1360
	354136	ANB	98.61	.562	7.61	325	13.115	8.70 @ 1425
	354137	ANC	98.63	.562	7.61	325	13.315	8.70 @ 1490
	346952	DD	107.33	.574	8.50	325	13.515	8.70 @ 1555
	346953	FA	107.36	.574	8.50	325	13.715	8.70 @ 1620
	346954	FB	107.39	.574	8.50	325	13.915	8.70 @ 1685
V-6	362199	AOK	98.88	.573	7.61	350	13.102	8.70 @ 1530
	362200	AOM	98.91	.573	7.61	350	13.302	8.70 @ 1600
	370904	AON	107.64	.586	8.50	350	13.50	8.70 @ 1670
	370906	AOR	107.67	.586	8.50	350	13.70	8.70 @ 1740
	370907	AOS	114.40	.599	9.00	350	13.90	8.70 @ 1810
	370908	AOT	114.40	.610	9.00	375	13.74	8.70 @ 1880

STEERING, DRIVELINE, WHEELS AND TIRES

STEERING

Wheel	
Type	Circular, 2-spoke
Diameter	15.0
Column	Energy absorbing - mast jacket, tube and steering shaft designed to collapse under various front impact conditions.
Gear - Type	
Manual (Std.)	Semi-reversible gear with ball-nut driven by recirculating anti-friction bearings
Power (Optional)	Same as manual except also has integral power piston. Hydraulic pressure provided from a vane type pump.
Ratios, Gear	
Manual	20.9:1
Power	16.0:1 on center to 13.0:1
Ratios, Overall	
Manual	22.5:1
Power	18.8 on center
Number of wheel turns, lock to lock	
Manual	4.4
Power	2.82
Linkage	Parallelogram type, ahead of front wheels
Turning Diameters	
Outside front, wall to wall	38.4
Outside front, curb to curb	35.8

DRIVELINE

Propeller Shaft	Tubular
Number Used	One
Diameter (O.D.)	2.75
Wall Thickness	0.065
Length (C/L of U joints)	
With L4 Engine	
4-Spd. Manual Trans.	47.44
Auto. Trans.	47.88
With V6 Engines	
4-Spd. Man. & Auto.	45.34
Universal Joints	
Type	Cross
Number Used	Two
Bearings	Prepacked, anti-friction

WHEELS - STANDARD

Type	Short spoke spider, steel
Rim Size	
1HM00 Models	13 x 5
1HR00 Models	13 x 6
Offset	0.20
Attachment to Hub	4 hex nuts
Thread Size	7/16-20 UNF-2B
Bolt Circle Diameter	4.00

WHEELS - OPTIONAL

Type	Rally H steel
Availability	Standard with RPO Z29 "Spyder Package"
Rim Size	13 x 6
Offset	0.45

TIRES, STANDARD

Size	
L-4 engines	A78-13
V-6 engines	B78-13
Type	Bias ply
Sidewall - Base	White stripe
Static Loaded Radius	
A78-13	10.98
B78-13	11.10
Loaded Rev/Mi @ 45 mph	
A78-13	889
B78-13	866
Capacity @ 24 psi	
A78-13	900
B78-13	980

TIRES, OPTIONAL

Sizes	BR70-13
Type	Steel belted radial
Sidewall	
Base	Blackwall
Optional	White stripe & white letter
Static Loaded Radius	
BR70-13	10.91
Loaded Rev/Mi @ 45 mph	
BR70-13	870
Capacity @ 24 psi	
BR70-13	980

SPARE TIRE

Base	Stowaway space saver
------	----------------------

REAR AXLE AND SUSPENSION

REAR AXLE

Description Three-piece housing includes integral cast iron differential carrier and housing with two pressed-in and welded steel tubes. Semi-floating axle shafts. Differential carrier contains hypoid overhung pinion and ring gear. Drive pinion supported by two taper roller bearings.

Drive Pinion Vertical Offset 1.50
 Drive Pinion Bearing Adjustment Shim
 Lubricant
 Type GL-5 Gear lubricant
 Viscosity 80W or 80W-90
 Capacity (pints) 3.5

AXLE SHAFT

Description Forged and hardened steel with integral drive flange
 Wheel Bearings Single row cylindrical roller
 Oil Seal .. Steel encased, spring loaded synthetic rubber

RING AND PINION GEAR TOOTH COMBINATIONS

Ring Gear Diameter 7.50 in.
 Axle Ratio
 2.56 16, 41
 2.73 15, 41
 2.93 14, 41

LIMITED SLIP DIFFERENTIAL

Type Cone clutches

REAR SUSPENSION

Description Torque arm with track bar, Salisbury rear axle and coil springs; parallel lower control arms.

Wheel Travel (Design)
 Total 7.39
 Jounce 2.75
 Rebound 4.64
 Wheel to spring, travel ratio 0.96:1

SHOCK ABSORBERS

Type Direct, double acting hydraulic
 Diameter, Piston 1.00

STABILIZER BAR - OPTIONAL

Type Link
 Material HR Steel
 Diameter - RPO F41 0.75
 RPO Z29 (V-6) 'Spyder' option 0.81

REAR SPRINGS

Selected from a family of springs by Electronic Data Processing which identifies the correct springs for the weight of the vehicle including optional equipment ordered by the customer.

REAR SPRING SPECIFICATIONS

Engine Application	Part Number	Assy. Code	Cut-Off Length	Wire Dia.	Total Coils	Deflection Rate (lbs./inch)	HEIGHTS	
							Free	Working (In. @ Lbs.)
All	346961	OL	91.79	.474	6.39	130	12.57	10.24 @ 300
	3988080	HS	107.06	.499	7.39	130	12.95	10.24 @ 350
	3988081	HT	107.11	.499	7.39	130	13.34	10.24 @ 400
	3988082	HW	107.17	.499	7.39	130	13.72	10.24 @ 450

BRAKES

GENERAL	Type		Front - Disc; Rear - Drum	
	System		Manual - Standard	Power - Optional
Front Brakes	Type		Dual circuit hydraulic system with warning light and self-adjusting features	
	Material		Disc - single piston floating caliper	
	Diameter and Width		Cast iron - solid, integral with hub	
	Lining Material		9.74 x 0.88	
	Method of attachment		Molded composition	
	Lining size (length x width x thickness)		Inboard	Integral bonding
			Outboard	5.26 x 1.54 x 0.430
	Lining area (sq. in.)		5.26 x 1.54 x 0.430	
	Effective area (sq. in.)		31.00	
	Swept area (sq. in.)		31.00	
	Piston diameter		146.94	
Rear Brakes	Type		2.50	
	Material		Drum - composite web cast into rim	
	Diameter and Width		Web - HR steel; Rim - Cast alloy iron	
	Lining material		9.5 x 2.0	
	Method of attachment		Molded composition	
	Lining size (length x width x thickness)		Primary	Riveted
			Secondary	7.30 x 1.99 x .23
	Lining area (sq. in.)		9.46 x 1.99 x .30	
	Effective area (sq. in.)		62.98	
	Swept area (sq. in.)		59.60	
Apply System	Piston diameter		116.09	
	Master cylinder diameter		0.6875	
	Piston travel		1.352	1.27
	Pedal travel		7.50	
	Pedal ratio		5.72:1	
Line pressure @ 100 lb. pedal load		1270		
Parking Brake	Type		Mechanical pull rods and cables operate rear service brakes.	
	Control		'ON' warning lamp provided.	
	Total effective area		Lever, floor mounted in center console	
		59.60		

BULBS AND LAMPS

BULBS AND LAMPS	NUMBER REQUIRED AND TRADE NUMBER	CANDLE POWER PER LAMP	
Automatic transmission quadrant	1-194	2	
Backing lamp	2-1156	32	
Parking brake alarm ind.	1-194	2	
Check engine indicator	1-194	2	
Directional signal indicators	2-194	2	
Dome	1-561	12	
Oil/Choke indicator	1-194	2	
Generator indicator	1-194	2	
Glove box lamp	1-1891	2	
Headlamp	Single 1HM00	2-6014	
	Dual 1HR00		High beam
		2-4651 (Inner)	Low beam
		2-4652 (Outer)	High beam 50W
		Low beam 60W	
		High beam 40W	
Headlamp hi-beam indicator	1-194	2	
Heater or A/C control	1-194	2	
Instrument cluster	9-194	2	
License plate, rear	2-194	2	
Parking & directional signal			
Park	2-1157	3	
Turn	(1HM00)	32	
Park	2-1157NA	2.2	
Turn	(1HR00)	24	
Radio - AM (RPO U63)	1-194	2	
Radio AM/FM (RPO U69)	1-194	2	
Radio - RPO U58	1-194	2	
Radio - UM1 & UM2	2-37	5	
Radio dial indicator light (RPO UN3)	2-37	5	
Seat belt warning indicator	1-194	2	
Side marker - front	2-194	2	
Side marker - rear	2-194	2	
Tail			
Tail	2-1157	3	
Stop & turn		32	
Underhood lamp	1-93	15	
W/S washer & light switch ind.	1-194	2	

FUSES AND CIRCUIT BREAKERS

CIRCUIT	TYPE OF PROTECTION	LOCATION AND CIRCUIT *
Air Conditioning	30 amp fuse	In line
	20 amp fuse	Fuse panel (d)
Automatic trans. indicator	4 amp fuse	Fuse panel (a)
Back-up lamps	20 amp fuse	Fuse panel (e)
Brake warning lamp	10 amp fuse	Fuse panel (b)
Check engine indicator	10 amp fuse	Fuse panel (b)
Cigarette lighter	20 amp fuse	Fuse panel (c)
Clock	20 amp fuse	Fuse panel (c)
Defogger, rear electric	10 amp fuse	Fuse panel (b)
Direction signal indicator	20 amp fuse	Fuse panel (f)
Direction signal indicator lamps	20 amp fuse	Fuse panel (f)
Dome lamp	20 amp fuse	Fuse panel (c)
Electric fuel pump	1 amp fuse	Fuse panel
Fuel gauge	10 amp fuse	Fuse panel (b)
Generator indicator lamp	10 amp fuse	Fuse panel (b)
Glove box lamp	20 amp fuse	Fuse panel (c)
Headlamps	Circuit breaker	Light switch
Headlight buzzer	10 amp fuse	Fuse panel (b)
Headlamp hi-beam indicator lamp	Circuit breaker	Light switch
Heater	20 amp fuse	Fuse panel (d)
Heater control lamps	4 amp fuse	Fuse panel (a)
Instrument cluster lamps	4 amp fuse	Fuse panel (a)
Key wiring buzzer	20 amp fuse	Fuse panel (c)
License plate lamp	20 amp fuse	Fuse panel (d)
Oil pressure indicator lamp	10 amp fuse	Fuse panel (b)
Park and turn lamp	20 amp fuse	Fuse panel
Radio	10 amp fuse	Fuse panel
Radio digital clock	20 amp fuse	Fuse panel (c)
Radio lamp	4 amp fuse	Fuse panel (a)
Seat belt warning lamp	10 amp fuse	Fuse panel (b)
Seat belt warning buzzer	10 amp fuse	Fuse panel (b)
Side marker lamps	20 amp fuse	Fuse panel (f)
Stop lamps	10 amp fuse	Fuse panel (f)
Tail, turn lamps	20 amp fuse	Fuse panel (f)
Temperature gauge	10 amp fuse	Fuse panel (b)
Temperature indicator lamp	10 amp fuse	Fuse panel (b)
Underhood lamp	20 amp fuse	Fuse panel (c)
Windshield wiper	25 amp fuse	Fuse panel
Windshield wiper switch	4 amp fuse	Fuse panel (a)
Windshield washer pump	25 amp fuse	Fuse panel (d)

* Letter suffix indicates same circuit

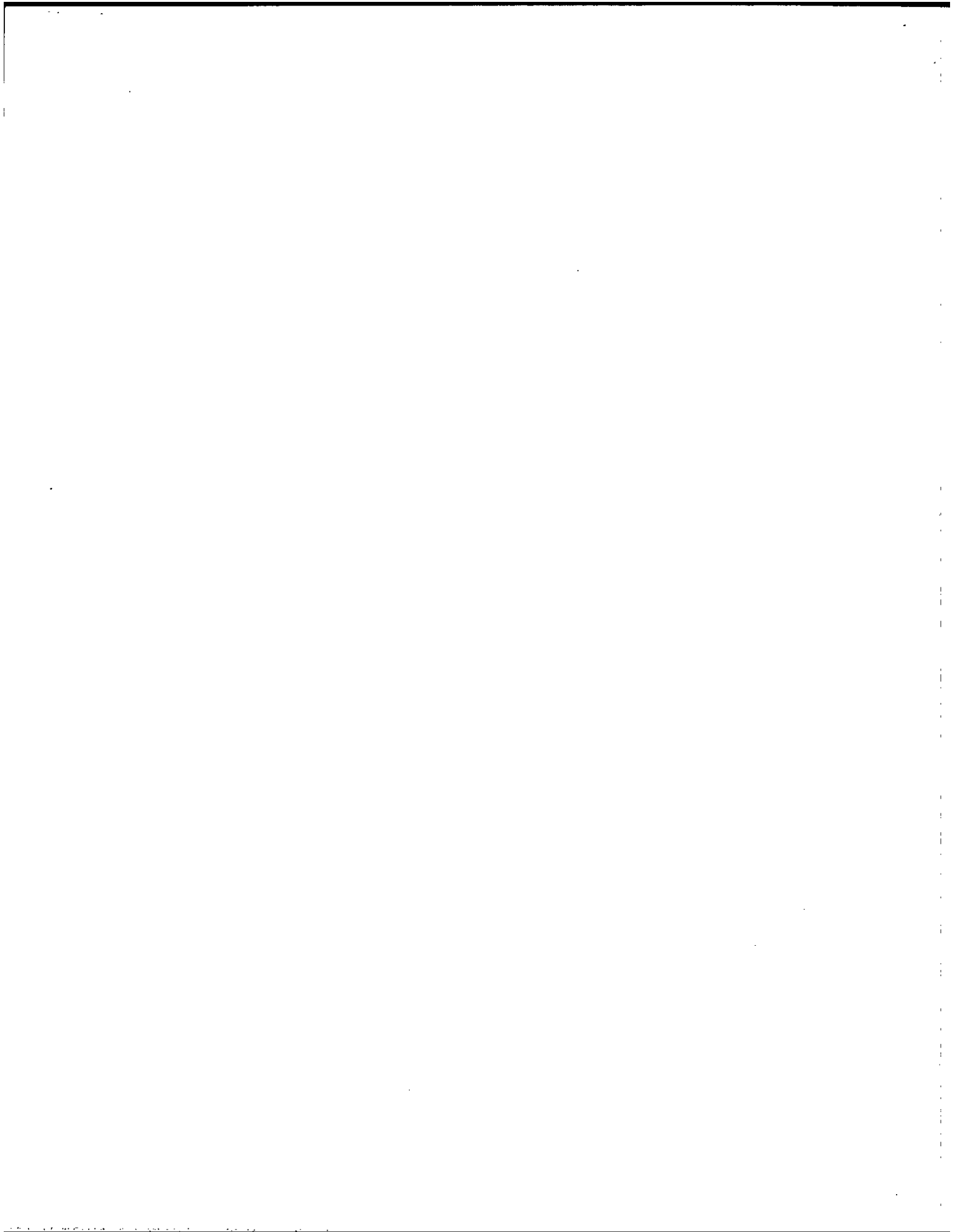

POWER TRAINS

POWER TEAM COMBINATIONS	2
POWER TEAM MULTIPLICATION FACTORS	3
ENGINE DATA AND RATINGS	4
ENGINE SPEED AND PISTON TRAVEL	5
VEHICLE PERFORMANCE FACTORS	6
PRINCIPAL COMPONENTS	7-10
FUEL SYSTEM	11
EXHAUST SYSTEM	11
EMISSION CONTROL EQUIPMENT	12
LUBRICATION SYSTEM	13
COOLING SYSTEM	14
ELECTRICAL SYSTEM	15
CLUTCHES	16
FOUR SPEED TRANSMISSIONS	16
THREE-SPEED AUTOMATIC TRANSMISSION	17

POWER TEAM COMBINATIONS

ENGINE	TRANSMISSION	MODEL APPLICATION	AXLE RATIOS**		LW. CLASS (lbs.)
			BASE	OPTION	
2.5 Liter L-4 (151 CID) LX8 Base - All exc. Calif.	Manual 4-Speed (3.50 low)	All	2.73+	2.93†	3125 (*)
	3-Speed Auto '200'		2.73	-	
2.5 Liter L-4 (151 CID) LX8 Base - Calif. Only	Manual 4-Speed (3.50 low)	All	2.93	-	3125 (*)
	3-Speed Auto '200'		2.73	-	
3.8 Liter V-6 (231 CID) LD5 Avail. - All exc. Calif.	Manual 4-Speed (3.50 low)	All	2.93	-	3375
	3-Speed Auto '350'		2.56	2.93	
3.8 Liter V-6 (231 CID) LD5 Avail. - Calif. only	Manual 4-Speed (3.50 low)	All	2.93	-	3375
	3-Speed Auto '350'		2.56	-	

+ - Not available with Air Conditioning.
 † - Base with Air Conditioning
 (*) - 3250 lbs. for M07 and R07 models.
 (**) - Ring gear diameter - 7.50".

MULTIPLICATION FACTORS

WITH MANUAL TRANSMISSION

ENGINE	TRANSMISSION	TOTAL GEAR REDUCTION					AXLE RATIO
		1st	2nd	3rd	4th	Rev.	
2.5 Liter L-4 (151 CID) LX8	4-Speed	8.85	6.27	4.20	2.73	8.85	2.73
	4-Speed	10.25	7.27	4.86	2.93	10.25	2.93
3.8 Liter V-6 (231 CID) LD5	4-Speed	10.25	7.27	4.86	2.93	10.25	2.93

WITH AUTOMATIC TRANSMISSION

ENGINE	TRANSMISSION	SELECTOR POSITION	TOTAL TORQUE MULTIPLICATION	AXLE RATIO
2.5 Liter L-4 (151 CID) LX8	3-Speed Auto '200'	Drive	17.58:1 - 2.73:1	2.73
		Second	17.58:1 - 4.29:1	
		Low	17.58:1 - 7.48:1	
		Reverse	13.28:1 - 5.65:1	
3.8 Liter V-6 (231 CID) LD5	3-Speed Auto '350'	Drive	12.90:1 - 2.56:1	2.56
		Second	12.90:1 - 3.89:1	
		Low	12.90:1 - 6.45:1	
		Reverse	9.88:1 - 4.94:1	
		Drive	14.77:1 - 2.93:1	2.93
		Second	14.77:1 - 4.45:1	
		Low	14.77:1 - 7.38:1	
		Reverse	11.31:1 - 5.65:1	

ENGINE DATA AND RATINGS

GENERAL DATA

Engine Type		L-4 Inline	90° V-6 OHV
Piston Displacement		2.5 Liter (151)	3.8 Liter (231)
Availability - RPO		LX8	LD5
Number of Cylinders		4	6
Bore		4.00	3.80
Stroke		3.00	3.40
Compression Ratio		8.2:1	8.0:1
SAE (Taxable) HP		25.6	34.7
Firing Order		1-3-4-2	1-6-5-4-3-2
Idling Speed	Manual (in Neutral)	1000	800
	Automatic (in Drive)	650	550
Compression Press. (PSI) @ Cranking Speed Engine Hot			
Power Plant Mounting		Two front and one rear	
Measurement	Fan to rear of engine block	26.3	27.1
	Top of air cleaner to bottom oil pan	26.1	29.0
	Exhaust manifold to generator	29.3	-

ADVERTISED ENGINE RATING

Engine Designation		2.5 Liter L-4 (151 CID)	3.8 Liter V-6 (231 CID)
Availability		RPO LX8	RPO LD5
Carburetor		2-Barrel	2-Barrel
Net Brake Horsepower @ RPM	Federal	86 @ 4000	110 @ 3800
	Calif.	86 @ 4000	110 @ 3800
Net Torque (lb.ft.) @ RPM	Federal	128 @ 2400	190 @ 1600
	Calif.	128 @ 2400	190 @ 1600

ENGINE SPEED AND PISTON TRAVEL

2.5 LITER L-4 ENGINE (RPO LX8)

Transmission		4-Speed Manual		3-Speed Automatic
Rear Axle Ratio		2.73	2.93	2.73
Tire Size		A78-13		
Crankshaft Revs./Mile		2427.0	2604.8	2427.0
Crankshaft RPM @ 1 MPH	Low	141.8	151.9	111.0
	Second	100.4	107.6	63.6
	Third	67.2	72.0	40.5
	Fourth	40.5	43.4	—
	Reverse	141.8	151.9	83.8
Piston Travel (Feet/Mile)		1213.5	1302.4	1213.5

3.8 LITER V-6 ENGINE (RPO LD5)

Transmission		4-Speed Manual		3-Speed Automatic	
Rear Axle Ratio		2.93	2.56	2.93	
Tire Size		B78-13			
Crankshaft Revs./Mile		2537.4	2217.0	2537.4	
Crankshaft RPM @ 1 MPH	Low	148.1	93.0	106.6	
	Second	104.9	56.1	64.3	
	Third	70.2	36.9	42.3	
	Fourth	42.3	—	—	
	Reverse	148.1	69.8	81.6	
Piston Travel (Feet/Mile)		1437.9	1256.3	1437.9	

VEHICLE PERFORMANCE FACTORS

ENGINE	2.5 Liter L-4 (151 CID) RPO LX8 86 HP	3.8 Liter V-6 (231 CID) RPO LDS 110 HP
MODEL	1HM07	1HR07

4-SPEED TRANSMISSION

Performance Weight (pounds)		3366	3536
Pounds/Net Horsepower	Federal	39.14	32.15
	Calif.	39.14	32.15
Pounds/Cu.In. Displacement		22.29	15.31
Net HP/Cu. In. Displacement	Federal	0.570	0.476
	Calif.	0.570	0.476
Power Displacement (cu.ft./mile)		106.0	169.6
Displacement Factor (cu.ft./ton mile)		63.0	95.9

3-SPEED AUTOMATIC TRANSMISSION

Performance Weight (pounds)		3344	3552
Pounds/Net Horsepower	Federal	38.88	32.29
	Calif.	38.88	32.29
Pounds/Cu.In. Displacement		22.15	15.38
Net HP/Cu. In. Displacement	Federal	0.570	0.476
	Calif.	0.570	0.476
Power Displacement (cu.Ft./mile)		106.0	148.2
Displacement Factor (cu.ft./ton mile)		63.4	83.4

GLOSSARY

Performance Weight	Curb Weight Plus 600 Lb. (weight of four 150 lb. passengers)
Power Displacement	$\frac{\text{Crankshaft Revs/Mi} \times \text{Piston Displacement}}{2 \times 1728}$
Displacement Factor	$\frac{\text{Power Displacement}}{\text{Performance Wt (tons)}}$

PRINCIPAL COMPONENTS

CYLINDER BLOCK

Material	
2.5 Liter L-4	Cast alloy iron
3.8 Liter V-6	Cast alloy iron
Bore Diameter	
2.5 Liter L-4	4.000-4.0024
3.8 Liter V-6	3.800
Bore Spacing	
2.5 Liter L-4	4.40
3.8 Liter V-6	4.24
Bearing Caps	
2.5 Liter L-4	5 cast iron, 2-bolt
3.8 Liter V-6	4 cast iron, 2-bolt
Water Jackets	
	Full length around each cylinder

CYLINDER HEAD

Type	
2.5 Liter L-4	Crossflow induction and exhaust configuration
Material	
	Cast alloy iron
Construction	
	Valve-in-head
Bolt No. & Size	
2.5 Liter L-4	10; .500 dia., 13 threads/in.
3.8 Liter V-6	16; .4375 dia., 14 threads/in.

COMBUSTION CHAMBER VOLUME

Total chamber volume of assembled engine with piston at top center	
2.5 Liter L-4	5.20 cu. in.
3.8 Liter V-6	5.35 cu. in.

INLET MANIFOLD

Material	
2.5 Liter L-4	Cast aluminum
3.8 Liter V-6	Cast alloy iron
Type	
2.5 Liter L-4	4-port design temperature controlled by engine coolant
3.8 Liter V-6	6-port, single deck

EXHAUST MANIFOLD

Material	
	Cast nodular iron
Type	
2.5 Liter L-4	3 port, center rear takedown
3.8 Liter V-6	Dual, 3-port, rear takedown
Outlet Diameter - in.	
2.5 Liter L-4	1.88
3.8 Liter V-6	

CRANKSHAFT

Material	
	Cast nodular iron
Counterweights	
2.5 Liter L-4	4
3.8 Liter V-6	
Crank Arm Length	
2.5 Liter L-4	1.500
3.8 Liter V-6	
End Play	
2.5 Liter L-4	.0035-.0085
3.8 Liter V-6	.003-.009
Drive and/or Timing Gear	
2.5 Liter L-4	Cast iron; gear
3.8 Liter V-6	Sintered iron; sprocket and chain
Pulley Pitch Diameter	
2.5 Liter L-4	6.64
3.8 Liter V-6	

MAIN BEARINGS

Material	
2.5 Liter L-4	Premium aluminum
3.8 Liter V-6	No. 1 upper - M400 Conecc, No. 1 lower - M100 Conecc, No. 2, 3 - M400, No. 4 - M100
Type	
	Precision removable Thrust Against Bearing
2.5 Liter L-4	No. 5
3.8 Liter V-6	No. 2
Clearance	
2.5 Liter L-4	.0002-.0022
3.8 Liter V-6	.0004-.0017

Dimensions

	Theoretical Inner Dia.	Effective Length	Projected Area (in. ²)
--	------------------------	------------------	------------------------------------

2.5 Liter L-4

Bearing No. 1,2,3,4	2.30	.80	1.840
Bearing No. 5	2.30	1.01	2.323

3.8 Liter V-6

Bearing No. 1,3,4	2.4995	.864	2.1595
Bearing No. 2	2.4995	1.057	2.6419

PRINCIPAL COMPONENTS

CAMSHAFT

Material	Cast alloy iron
Location	
2.5 Liter L-4	Right side of engine block
3.8 Liter V-6	Above crank at center of 'V'
Type of Drive	
2.5 Liter L-4	Bakelite & fabric composition with steel hub drive sprocket.
3.8 Liter V-6	Aluminum nylon coated sprocket; chain drive.
Lobe Lift	
2.5 Liter L-4	0.2315 inlet & exhaust
3.8 Liter V-6	.2508 inlet; .2403 exhaust
Bearings	
2.5 Liter L-4	3; steel backed babbitt
3.8 Liter V-6	4; steel backed babbitt

VALVE TRAIN

Type	Individually mounted, overhead rocker arms, push rod actuated
Valve Lifters	Hydraulic
Rocker Arm Ratio	
2.5 Liter L-4	1.75:1
3.8 Liter V-6	1.55:1
Push Rods	
Type	Hollow steel
Ends	Hardened
Valve Lift	
2.5 Liter L-4	.404 inlet & exhaust
3.8 Liter V-6	.358 inlet; .366 exhaust

VALVE SPRINGS

Diameter (I.D.)	
2.5 Liter L-4	0.880
3.8 Liter V-6	.872-.888
Free Length	
2.5 Liter L-4	2.08
3.8 Liter V-6	2.03

VALVE SPRINGS (Continued)

Installed Length (lb. @ in.)	
Valves closed	
2.5 Liter L-4	70 @ 1.66
3.8 Liter V-6	64 @ 1.727
Valves opened	
2.5 Liter L-4	166 @ 1.254
3.8 Liter V-6	
Inlet	174-190 @ 1.34
Exhaust	174-190 @ 1.34
Damper	
3.8 Liter V-6	Flat steel, 4 coils

VALVE TIMING (Crankshaft Degrees - Excluding Ramps)

2.5 Liter L-4	
Inlet Valve	
Opens - °BTC	33
Closes - °ABC	81
Duration	294
Exhaust Valve	
Opens - °BBC	76
Closes - °ATC	38
Duration	294
3.8 Liter V-6	
Inlet Valve	
Opens - °BTC	16
Closes - °ABC	63
Duration	259
Exhaust Valve	
Opens - °BBC	68
Closes - °ATC	29
Duration	277

PRINCIPAL COMPONENTS

VALVES - INLET

Material

2.5 Liter L-4	1541 steel with aluminized face
3.8 Liter V-6	SAE 1541 steel
All stems	Chrome flash

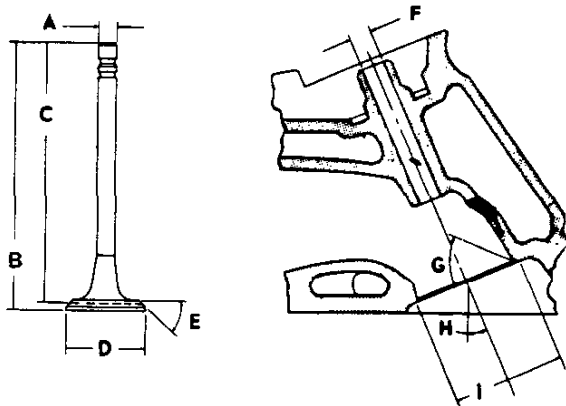

A - Stem Diameter	
2.5 Liter L-4	.3418-.3425
3.8 Liter V-6	.3402-.3412
B - Overall Length	
2.5 Liter L-4	4.577
3.8 Liter V-6	4.698-4.728
C - Gage Length	
2.5 Liter L-4	4.807-4.817
3.8 Liter V-6	4.575-4.595
D - Overall Head Diameter	
2.5 Liter L-4	1.720
3.8 Liter V-6	1.710
E - Angle of Face (°)	45
F - Guide Diameter	
2.5 Liter L-4	.3435-.3445
3.8 Liter V-6	.3427-.3437
G - Angle of Seat (°)	
2.5 Liter L-4	46
3.8 Liter V-6	45
H - Valve Angle (°)	
2.5 Liter L-4	9
3.8 Liter V-6	
I - Valve Seat Diameter	
2.5 Liter L-4	1.625
3.8 Liter V-6	

VALVE EXHAUST

Material

2.5 Liter L-4	21-2N steel with aluminized face
3.8 Liter V-6	21-2N steel with aluminized face
Stems	Chrome flash

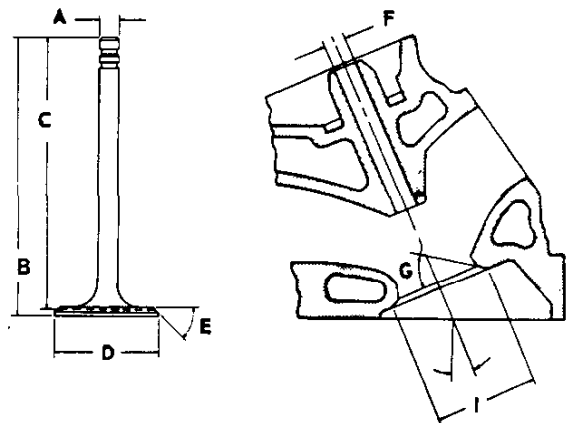

A - Stem Diameter	
2.5 Liter L-4	.3418-.3425
3.8 Liter V-6	.3405-.3412
B - Overall Length	
2.5 Liter L-4	4.489
3.8 Liter V-6	4.703-4.713
C - Gage Length	
2.5 Liter L-4	4.784-4.794
3.8 Liter V-6	4.575-4.595
D - Overall Head Diameter	
2.5 Liter L-4	1.500
3.8 Liter V-6	1.500
E - Angle of Face (°)	45
F - Guide Diameter	
2.5 Liter L-4	.3435-.3445
3.8 Liter V-6	.3427-.3437
G - Angle of Seat (°)	
2.5 Liter L-4	45
3.8 Liter V-6	45
H - Valve Angle (°)	
2.5 Liter L-4	9
3.8 Liter V-6	
I - Valve Seat Diameter	
2.5 Liter L-4	1.375
3.8 Liter V-6	

PRINCIPAL COMPONENTS

PISTONS

Material	Cast aluminum alloy
Head Type	
2.5 Liter L-4	Sump
3.8 Liter V-6	Dished
Skirt	
2.5 Liter L-4	Cam ground slipper
3.8 Liter V-6	Full with transverse slot
Top Land Clearance	
2.5 Liter L-4	.025-.031
3.8 Liter V-6	.046-.056
Skirt Clearance	
2.5 Liter L-4	.0025-.0033
3.8 Liter V-6	.0008-.0020
Compression Ring Groove Depth	
2.5 Liter L-4	.1785-.1985
3.8 Liter V-6	
Oil Ring Groove Depth	
2.5 Liter L-4	.2050-.2110
3.8 Liter V-6	
Pin Bore Offset	
2.5 Liter L-4	.063
3.8 Liter V-6	.040
Compression Height	
2.5 Liter L-4	1.568-1.592
3.8 Liter V-6	

PISTON PINS

Material	
2.5 Liter L-4	Chromium steel
3.8 Liter V-6	Extended SAE 1018
Pin Mounting	
2.5 Liter L-4	Locked in rod
3.8 Liter V-6	Pressed in rod
Length	
2.5 Liter L-4	3.000
3.8 Liter V-6	2.900
Diameter	
2.5 Liter L-4	.938-.942
3.8 Liter V-6	.9391-.9394
Clearance in Piston	
2.5 Liter L-4	.0002-.0004
3.8 Liter V-6	.0004-.0007

COMPRESSION RING - UPPER

Material	Cast alloy iron
Type	
2.5 Liter L-4	Reverse twist
3.8 Liter V-6	Straight edge inside of ring
Face	
2.5 Liter L-4	Barrel
3.8 Liter V-6	Barrel
Coating	
2.5 Liter L-4	Moly channel
3.8 Liter V-6	Molybdenum filled channel
Width	
2.5 Liter L-4	.0728
3.8 Liter V-6	.168-.178

COMPRESSION RING - UPPER (Continued)

Wall Thickness	
2.5 Liter L-4	0.177-.187
3.8 Liter V-6	.168-.178
Gap	
2.5 Liter L-4	0.013-.023
3.8 Liter V-6	.013-.023

COMPRESSION RING - LOWER

Material	Cast alloy iron
Type	
2.5 Liter L-4	Reverse twist
3.8 Liter V-6	Inside bevel
Face	
2.5 Liter L-4	Tapered
3.8 Liter V-6	Reverse tapered
Coating	
2.5 Liter L-4	Tin plate
3.8 Liter V-6	Phosphate
Width	
2.5 Liter L-4	.0728
3.8 Liter V-6	.077-.078
Wall Thickness	
2.5 Liter L-4	.177-.187
3.8 Liter V-6	.168-.178
Gap	
2.5 Liter L-4	.010-.020
3.8 Liter V-6	.013-.023

OIL CONTROL RINGS

Type	Multi-piece (two rails and one spacer)
Material	
Rails	Steel
Spacer	Stainless steel
Width (Assembled)	
2.5 Liter L-4	.186
3.8 Liter V-6	.135-.142
Wall Thickness	
2.5 Liter L-4	.152-.158
3.8 Liter V-6	.148-.152
Gap	
2.5 Liter L-4	0.015-.055
3.8 Liter V-6	0.015-.035

CONNECTING RODS

Material	
2.5 Liter L-4	Arma steel
3.8 Liter V-6	Arma steel

CONNECTING ROD BEARINGS

Material	Premium aluminum
Type	Precision removable
Clearance	
2.5 Liter L-4	.0005-.0026
3.8 Liter V-6	.0005-.0026
Theoretical Diameter	
2.5 Liter L-4	2.1252
3.8 Liter V-6	
Effective Length	
2.5 Liter L-4	.737
3.8 Liter V-6	.737
End Play	
2.5 Liter L-4	.006-.022
3.8 Liter V-6	.006-.023

FUEL AND EXHAUST SYSTEMS

FUEL SYSTEM

FUEL TANK

Capacity (gal.)	18.5 (approximately)
Location	In recessed well of rear underbody
Filler Location	Left rear quarter

FUEL FILTERS

In Fuel Tank	Mesh strainer
In Carburetor Inlet	Paper element

FUEL PUMP

Type	
2.5 Liter L-4	Mechanical
3.8 Liter V-6	Electric
Location	
2.5 Liter L-4	Right side front of engine
3.8 Liter V-6	Mounted in fuel tank
Pressure Range (PSI)	
2.5 Liter L-4	5.0-6.5
3.8 Liter V-6	4.25-5.75

AIR CLEANER

Type	
2.5 Liter L-4	Ducted outside air, replaceable paper element, single snorkel, Thermac
3.8 Liter V-6	Closed paper element, single snorkel

CHOKE

Type	
2.5 Liter L-4	Electric
3.8 Liter V-6	Electric

CARBURETORS

Type	
2.5 Liter L-4	Varajet, 2-stage, 2-barrel
3.8 Liter V-6	Dualjet 2-barrel, downdraft
SAE Flange Size	
2.5 Liter L-4	1.25
3.8 Liter V-6	
Throttle Bore	
2.5 Liter L-4	
Primary	1.24
Secondary	1.40
3.8 Liter V-6	1.4375
Venturi Diameter	
2.5 Liter L-4	
Primary	1.10
Secondary	Air valve
3.8 Liter V-6	1.093

EXHAUST SYSTEM

TYPE

2.5 Liter L-4	Single with converter
3.8 Liter V-6	Single, exhaust system with converter and crossover

MUFFLER

Type	Oval, reverse flow
Construction	Heads and body joined by rolled lock seam construction
Head	0.057 sheet steel aluminized
Shell	0.031 sheet steel aluminized
Wrap	0.060 indented asbestos sheet
Cover	0.015 sheet steel aluminized
Body - Length	18.00
- Height	5.00
- Width	9.25

EXHAUST PIPE TO CONVERTER

Material	Laminated tubing
Dimension (O.D.)	
Crossover	
3.8 Liter V-6	2.25
To Converter	
2.5 Liter L-4	
Federal	1.75
California	2.00
3.8 Liter V-6	2.00

EXHAUST PIPE - CONVERTER TO MUFFLER

Dimension (O.D.)	
2.5 Liter L-4	2.00
3.8 Liter V-6	2.25

TAILPIPE

Material	Steel tubing aluminum coated
Dimensions (O.D.)	
2.5 Liter L-4	2.00
3.8 Liter V-6	2.00

EMISSION CONTROL EQUIPMENT

SYSTEM APPLICATION

SYSTEM TYPE	Engine Adaptation			
	2.5 Liter L-4		3.8 Liter V-6	
	Federal	Calif.	Federal	Calif.
PAI - Pulse Air Injection	X	-	-	-
CHA - Carburetor Hot Air	X	X	X	X
COA - Carburetor Outside Air	X	X	-	-
P-EGR - Exhaust Pressure Modulated EGR	X	-	X	X
UFC - Underfloor Converter	X	-	X	-
EGR - Exhaust Gas Recirculation	-	X	-	-
C-4 - Computer Controlled Catalytic Converter	-	X	-	X
EST - Electronic Spark Timing	-	-	-	X
FEC - Fuel Evaporation Control	X	X	X	X
PCV - Positive Crankcase Ventilation	X	X	X	X
AIR - Air Injection Reactor	-	-	X	X
EFE - Early Fuel Evaporation	-	-	X	X

BASIC FUNCTIONS OF SYSTEMS

PULSE AIR INJECTION

Compresses, regulates and distributes quantities of air to the exhaust manifold to more completely burn carbon monoxide and hydrocarbon emissions.

CARBURETOR HOT AIR

A thermostatically controlled air induction system designed to aid carburetion. Consists of a heat stove to supply preheated air and a vacuum powered damper to mix air normally drawn in through the snorkel with the hot air. Produces a more uniform carburetor air temperature which permits proper emission control with improved engine operation.

CARBURETOR OUTSIDE AIR

Duct work connecting air cleaner snorkel to air source outside of engine compartment. Provides cooler outside air to CHA system for improved performance after engine warm-up.

EXHAUST PRESSURE MODULATED EGR

Meters exhaust gas into induction system for recirculation throughout the combustion cycle to reduce oxides of nitrogen emissions. Exhaust pressure modulation in addition to vacuum modulation to increase control perimeters.

UNDERFLOOR CATALYTIC CONVERTER

A device placed in the exhaust system containing the catalytic bed through which exhaust gasses are passed. The catalyst may be configured to cause both a reduction and oxydation reaction, or an oxydation reaction only.

EXHAUST GAS RECIRCULATION

Meters exhaust gas into induction system for recirculation through the combustion cycle to reduce oxides of nitrogen emissions.

COMPUTER CONTROLLED CATALYTIC CONVERTER

A system designed to monitor engine functions and through an on-board computer, combine precise electronic carburetor control of fuel air ratio near the stoichiometric with an oxidation-reduction catalytic converter to control emissions. This system achieves low levels of hydrocarbons and carbon monoxide emissions while significantly lowering oxides of nitrogen.

ELECTRONIC SPARK TIMING

Conventional vacuum and centrifugal advance mechanisms replaced by electronic components to optimize spark timing for better exhaust emissions control and fuel economy.

FUEL EVAPORATION CONTROL

Controls emission of gasoline vapors to the atmosphere by means of an integral separator chamber within the fuel tank that separates vapor from liquid fuel - a filler cap that doesn't permit venting into the atmosphere - a canister for storage of vapors - lines, hoses and valves to control and transport vapors from fuel tank and carburetor float bowl to storage, and finally, to the carburetor for utilization in running the engine.

POSITIVE CRANKCASE VENTILATION

Withdraws oil and gas vapors from the various cavities throughout the engine for burning in the combustion cycle.

AIR INJECTION REACTOR

Compresses, regulates and distributes quantities of air to the exhaust to more completely burn carbon monoxide and hydrocarbon emissions.

EARLY FUEL EVAPORATION

A thermostatically controlled system designed to supply hot exhaust gasses to heat carburetor base and inlet manifold during early stages of cold engine operation. Improves cold engine driveability during warm-up.

LUBRICATION SYSTEM

GENERAL

Type	Controlled fuel pressure
Main Bearings	Pressure
Piston Pins	Splash
Cylinder Walls	
2.5 Liter L-4	Splash
3.8 Liter V-6	Splash
Camshaft Bearings	Pressure
Hydraulic Lifters	
2.5 Liter L-4	Pressure
3.8 Liter V-6	Pressure
Connecting Rods	Pressure
Oil Pressure Sending Unit	Electric
	opens or closes circuit @ 2 to 6 PSI
Oil Filler	
Cap	Positive seal
Location	
2.5 Liter L-4	Top front of valve cover
3.8 Liter V-6	Top rear of left valve cover

OIL PUMP

Type	Gear
Regulator Valve - V8	Opens between 40-45 lbs. 35 PSI for L-4 & V-6
L-4 & V-6	35 PSI
Oil Pressure (lbs. @ engine RPM)	
2.5 Liter L-4	36-41 @ 2000
3.8 Liter V-6	37 @ 2400
Intake, Type	Fixed pickup with screen

OIL FILTER

Type	Full flow, throwaway type
Location	
2.5 Liter L-4	Lower front right side
3.8 Liter V-6	Lower right front side
Capacity	
2.5 Liter L-4	0.6 pint
3.8 Liter V-6	0.6 pint
By Pass Valve	Opens between 10-12 PSI drop in pressure

LUBRICANT GRADES AND TEMPERATURES

20°F and above	10W-30, 10W-40, 20W-20, 20W-40, 20W-50
0 to 60°F	10W, 5W-30, 10W-30, 10W-40
Below 20°F	5W-20, 5W-30

OIL PAN CAPACITIES (Quarts)

Refill	
2.5 Liter L-4	3.0
3.8 Liter V-6	4.0
Refill with Filter Change	
2.5 Liter L-4	3.3
3.8 Liter V-6	4.3

COOLING SYSTEM

GENERAL

Type Pressure, vented three coolant recovery system

Capacity - Quarts

2.5 Liter L-4
 Manual Trans. 11.52
 Automatic Trans. 11.40
 3.8 Liter V-6
 Manual Trans. 11.92
 Automatic Trans. 11.80

RADIATOR

Type Cross flow, tube and center

Distance Between Fins
 2.5 Liter L-4 0.18
 3.8 Liter V-6
 Manual Trans. 0.25
 Automatic Trans. 0.22
 Distance Between Tubes 0.55
 Core Thickness 1.24
 Frontal Area (Sq. In.)
 2.5 Liter L-4 248
 3.8 Liter V-6 300
 Overflow Separate coolant bottle

RADIATOR, HEAVY DUTY (RPO V01)

Distance Between Fins
 2.5 Liter L-4 & 3.8 Liter V-6
 Manual Trans. 0.16
 Automatic Trans. 0.14
 Distance Between Tubes 0.55
 Core Thickness 1.24
 Frontal Area - Sq. In. 300
 Overflow Separate coolant bottle

RADIATOR CAP RELIEF VALVE

Opens at Approximately 15 psi

THERMOSTAT

Type Pellet
 Begins to Open 195° F
 Fully Open @ 227° F

RADIATOR HOSE

Outlet, Lower (Radiator to water pump)
 Type Molded
 Inner Diameter 1.50
 Inlet, Upper (Thermostat hsg. to radiator)
 Type Molded
 Inner Diameter
 2.5 Liter L-4 1.25
 3.8 Liter V-6 1.50

FAN

Type
 2.5 Liter L-4 4-blade
 3.8 Liter V-6 4-blade
 Diameter - In.
 2.5 Liter L-4 15.0
 3.8 Liter V-6 19.0

WATER PUMP

Type Centrifugal
 Capacity (GPM @ Pump RPM)
 2.5 Liter L-4 11 @ 1000
 3.8 Liter V-6 10 @ 1000
 Drive Fan belt
 Ratio (Pump to Engine RPM)
 2.5 Liter L-4 1.16:1
 3.8 Liter V-6 0.949:1

DRAIN LOCATIONS

Engine Block - Plug
 2.5 Liter L-4 Left side
 3.8 Liter V-6 None
 Radiator - Petcock Lower right rear face

ELECTRICAL SYSTEM

SUPPLY SYSTEM

BATTERY

Type	Freedom
Voltage Rating and Watts	
2.5 Liter L-4	12-3200
3.8 Liter V-6	12-2500
Number of Cells	6
Cold Cranking Rating (reserve capacity)	
2.5 Liter L-4	80 minute
3.8 Liter V-6	60 minute
Terminal Grounded	Negative
Location (in engine compartment)	
2.5 Liter L-4	Right front
3.8 Liter V-6	Right front

ALTERNATOR

Type	Diode rectified
Rating	
Amps	37
Volts	12
Drive	Fan belt
Pulley P.D.	
2.5 Liter L-4	2.70
3.8 Liter V-6	2.74
Ratio (alternator to engine speed)	
2.5 Liter L-4	2.36:1
3.8 Liter V-6	2.43:1

REGULATOR

Type	Micro-circuit unit, integral with alternator
Voltage	13.8-14.8 @ 85°F

IGNITION SYSTEM

Type	High Energy Ignition (HEI)
Distributors	Refer to chart below

STARTING SYSTEM

Starting Motor

Rotation (drive end view)	Clockwise
Motor Drive	Positive shift solenoid
Pinion Meshes at	Front
Pinion Tooth Number	9
Flywheel Tooth Number	
2.5 Liter L-4	153
3.8 Liter V-6	160
Mounting	Bolted to clutch housing

COIL

Type	Integral with distributor
------	---------------------------

SPARK PLUGS

Type	
2.5 Liter L-4	R44TSX
3.8 Liter V-6	R45TS
Thread Size	14
Gap	
2.5 Liter L-4	0.060
3.8 Liter V-6	0.045
Torque (lb. Ft.)	
2.5 Liter L-4	15
3.8 Liter V-6	15-25

CABLE	Linen core impregnated with electrical conducting material and insulation of rubber with silicone rubber jacket
-------	---

Distributors	2.5 Liter L-4 RPO LX8			3.8 Liter V-6 RPO LD5		
	1110559	1110558	(1110560)	1110554	1110555	(1110784)
Model						
Type	High Energy Ignition (H.E.I.)					
Centrifugal Advance Begins @ RPM	0 @ 1200	0 @ 1000	0 @ 1000	0 @ 1680	0 @ 950	
Max. Degrees @ RPM	14 @ 4000	14 @ 4000	14 @ 4400	15 @ 3600	15 @ 3600	
Vacuum Adv. Begins @ In. Hg	0 @ 3	0 @ 3	0 @ 4	0 @ 3	0 @ 4	
Max. Degrees @ In. Hg.	15 @ 5	15 @ 5	20 @ 10	24 @ 12	24 @ 11	
Timing (initial design setting) Crankshaft Deg @ RPM w/Vacuum Line Disconnected	12° BTC			15° BTC		
Timing Mark Location	Torsional damper					

NOTE: (Data in brackets () pertains to California.)

CLUTCHES AND TRANSMISSIONS

CLUTCHES

Engine		2.5 Liter L-4	3.8 Liter V-6	
Clutch for		4-Speed		
Type		Single dry disc centrifugal		
Clutch cover & pressure plate	Eff. plate load, lbs.	1250-1450	2100-2300	
	Press. plate matl.	Cast iron		
	Clutch spring type	Diaphragm, bent finger design		
	Clutch spring matl.	Heat treated spring steel		
Driven plate	Type	Single disc with two friction surfaces		
	Cushions	Flat spring steel between friction rings		
	Dampers	8 coil springs (4 sets of two)		
	Friction rings	OD	9.12	10.34
		ID	6.12	6.50
		Total area sq. in.	71.82	101.5
Material		Woven type asbestos		
Flywheel	Flywheel Material	Nodular iron		
	Ring gear Material	Heat treated HR steel		
	No. of teeth	153		
	PD	12.75	13.4	
Bearings	Release	Type	Single row ball	
		Lubrication	None, prepacked	
	Pilot	Type	Bronze bushing	
		Lubrication	None, sintered and oil impregnated	
Controls	Clutch fork	Drop forged steel, pivot mounted on ball		
	Pedal mounting	Pendant, from brace on dash		
	Lubrication	Crossover shaft		
Clutch housing material		Aluminum alloy		

4-SPEED TRANSMISSION

Transmission Type		2.5 Liter L-4	3.8 Liter V-6	
Case material		4-Speed		
Case material		Cast Iron		
Gear Shift	Type	Remote		
	Control	Lever		
	Location	Floor, mounted between seats		
Gears	Type	Helical		
	Material	Forged steel, hardened		
	Synchronization	All forward gears		
	Constant mesh gear	All forward gears		
	Sliding gears	Reverse		
	Ratios	First	3.50	
		Second	2.48	
		Third	1.66	
Fourth		1.00		
Reverse		3.50		
Lubricant	Type	GL-5 Gear lube		
	Capacity (pts)	3		
Extension	Material	Aluminum		
	Oil Seal	Steel encased seal of spring loaded silicone		

TRANSMISSION

THREE-SPEED AUTOMATIC TRANSMISSION

Engine	Displacement	2.5 Liter L-4	3.8 Liter V-6	
General Data	Type	Automatic hydraulic torque converter with compound planetary gear system - three forward speeds and reverse.		
	Selector lever	Location	Floor tunnel (a)	
		Operation	Actuates controls by a hydraulic system from pressurized gear type pump	
		Quadrant pattern	P-R-N-D-L2-L1	
	Parking Lock	Type	Locking pawl	
		Operation	Applied by selector lever through manual linkage	
	Method of cooling	Water		
	Flywheel assembly	Steel stamping with welded on ring gear		
	Oil pressure pump	Supplies hydraulic pressure from an engine driven gear type pump		
	Hydraulic System	Type	Steel spool valve	
Valves		Manual	Establishes range at transmission operation	
		Pressure regulator	Provides main line pressure	
		Shift (1-2)	Controls oil pressure for transmission shift from 1-2 or 2-1	
		Shift (2-3)	Controls oil pressure for transmission shift from 2-3 or 3-2	
Modulator		Regulates line pressure with modulator oil pressure which varies with torque to transmission		
Accumulator		Provides greater flexibility in attaining desired shift quality for various engine requirements		
Pressure @ Idle (b)		Drive	55	
		L2	80	
		L1	80	
	Reverse	84		
Converter Assembly	Pump (Drive member)	Multivane type, sheet metal blade spot welded to steel pump housing that is an integral part of the converter housing		
	Turbine (Driven member)	Steel axial flow blades assembled between inner and outer steel shells		
	Stator assembly	Aluminum multivane type blades mounted on a one way (overrunning) roller clutch		
	Stall ratio	2.35	2.0	
	Stall speed (RPM)	2450		
	Diameter (nominal)	10.0	11.75	
Planetary Gear Set	Reaction carrier assembly	4 steel pinion gears		
	Output carrier assembly	4 steel pinion gears		
	Intermediate band	Circular steel with organic lining		
	Range	D (Drive)	2.74-1.57-1.0	2.52-1.52-1.0
		L2 (Low two)	2.74-1.57	2.52-1.52
		L1 (Low one)	2.74	2.52
		R (Reverse)	2.07	1.93
Servo Unit	Piston with release spring and inner cushion spring			
Case	Material	Aluminum		
	Type	Three, multiple disk		
Clutches	Material	Drive plates	Steel with bonded organic facings	
		Driven plates	Flat steel	
	Forward clutch	4 each drive & driven plates		
	Direct clutch	3 each drive & driven plates		
	Low & Reverse clutch	4 each drive & driven plates		
	Release spring	Radial row steel coil		
Torque Multiplication	Drive (maximum)	6.44:1 to 1.00	5.04:1 to 1.00	
	Low 2	6.44:1 to 1.57	5.04:1 to 1.52	
	Low 1	6.44:1 to 2.74	5.04:1 to 2.52	
	Reverse	4.86:1 to 2.07	3.86:1 to 1.93	
Governor	Type	Cross-axis centrifugal		
	Operation	Regulates a pressure proportional to car speed which acts upon the (1-2) (2-3) shift and modulator valves		
Lubricant	Type	Dexron II		
	Capacity (pints)	Dry	20	
		Refill	5.7	7

- (a) Floor mounted automatic mini-console available as an option, quadrant changes to P R-N-3-2-1.
 (b) Conditions: 600 RPM input

