

1984
CHEVROLET
K-BLAZER

K BLAZER

INTERIOR AND EXTERIOR COLOR AVAILABILITY CHART

Please Note: Below are the interior trim color and exterior paint combinations *recommended* by Chevrolet. The only available primary/secondary exterior color combinations are those shown in the chart below; however, any available interior trim color may be ordered with one of these exterior color combinations if that particular combination is desired by the customer.

INTERIOR COLORS		Decor	Blue	Burgundy	Saddle Tan	Slate Grey		
CUSTOM DELUXE								
Vinyl High Back Bucket Seats		Std.	VDD4		VSS4			
Custom Vinyl High Back Bucket Seats			XDD4		XSS4			
SILVERADO								
Custom Vinyl High Back Bucket Seats		YE9	XDD4	XEE4	XSS4	XTT4		
Custom Cloth High Back Bucket Seats			LDD4	LEE4	LSS4	LTT4		
EXTERIOR COLORS w/ZY1 or ZY3 PAINT	Primary	Secondary	RECOMMENDED INTERIOR TRIM COLOR				Required Body	
BLACK, MIDNIGHT	19	19		X	X	X	Z58, Z59	
Silver (Metallic)	19	17				X	Z59	
Tan, Doeskin	19	61			X		Z59	
White, Frost	19	12				X	Z58, Z59	
BLUE, LIGHT (Metallic)	21	21	X			X	Z58, Z59	
Blue, Midnight	21	29	X				Z58	
Silver (Metallic)	21	17	X			X	Z59	
White, Frost	21	12	X				Z58	
BLUE, MIDNIGHT	29	29	X			X	Z58, Z59	
Blue, Light (Metallic)	29	21	X				Z58	
White, Frost	29	12	X				Z58	
BRONZE, INDIAN (Metallic)	66	66			X		Z58, Z59	
White, Frost	66	12			X		Z58	
RED, APPLE	72	72		X	X		Z58, Z59	
White, Frost	72	12		X			Z58	
SAND, DESERT (Metallic)	64	64			X		Z58, Z59	
Black, Midnight	64	19			X		Z59	
White, Frost	64	12			X		Z58	
SILVER (Metallic)	17	17	X	X		X	Z58, Z59	
Black, Midnight	17	19				X	Z59	
White, Frost	17	12				X	Z58	
TAN, DOESKIN	61	61			X		Z58, Z59	
Black, Midnight	61	19			X		Z59	
White, Frost	61	12			X		Z58	
WHITE, FROST	12	12	X	X	X	X	Z58, Z59	
Black, Midnight	12	19		X		X	Z58, Z59	
Blue, Light (Metallic)	12	21	X				Z58	
Blue, Midnight	12	29	X				Z58	
Red, Apple	12	72		X			Z58	
Silver (Metallic)	12	17				X	Z58	
Tan, Doeskin	12	61			X		Z58	
YELLOW, COLONIAL	53	53			X		Z58, Z59	
Black, Midnight	53	19			X		Z59	
White, Frost	53	12			X		Z58	
w/ZY5 (Exterior and Interior Combinations Shown are the Only Combinations Available)								
BLACK, MIDNIGHT/Red, Apple	19	72		X			Z59	VERMILLION/BLACK
BLACK, MIDNIGHT/Silver (Metallic)	19	17				X	Z59	VERMILLION/LIGHT SLATE
BLACK, MIDNIGHT/Tan, Doeskin	19	61			X		Z59	VERMILLION/BLACK
BLACK, MIDNIGHT/White, Frost	19	12				X	Z58, Z59	VERMILLION/BLACK
WHITE, FROST/Black, Midnight	12	19				X	Z58, Z59	VERMILLION/BLACK
WHITE, FROST/Blue, Light (Metallic)	12	21	X				Z58	DARK BLUE/LIGHT BLUE
WHITE, FROST/Red, Apple	12	72		X			Z58	VERMILLION/DARK CARMINE
WHITE, FROST/Tan, Doeskin	12	61			X		Z58	DARK BROWN/ALMOND
YELLOW, COLONIAL/Tan, Doeskin	53	61			X		Z58	DARK BROWN/ALMOND
YELLOW, COLONIAL/White, Frost	53	12			X		Z58	DARK BROWN/ALMOND

Paint Applications

SOLID PAINT—ZY1

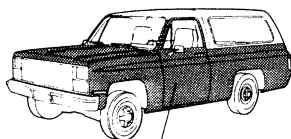

Primary Body Color

SPECIAL TWO-TONE PAINT—ZY3 (Includes YG1 Moldings)



Secondary Body Color

EXTERIOR DECOR PACKAGE—ZY5 (Includes YG1 Moldings and Hood Ornament)



Primary Body Color

AVAILABLE SEAT ARRANGEMENTS

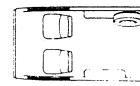

W/YG4



W/AM7

MODEL AND BODY

Reqs AM7 Folding Seat or YG4 Seat Not Desired.

Description	Model No	Body	Wheelbase
4-WHEEL-DRIVE GASOLINE MODELS			
White Top	CK10516	Z58	106.5"
Black Top	CK10516	Z59	106.5"

Description	Model No	Body	Wheelbase
4-WHEEL-DRIVE DIESEL MODELS			
White Top	CK10516	Z58/B3J	106.5"
Black Top	CK10516	Z59/B3J	106.5"

EMISSIONS (MUST ORDER ONE)

- NA5 Standard Emission Equipment**
 NA6 High Altitude Emission Equipment
 YF5 California Emission Requirements

POWER TEAMS (MUST ORDER ENGINE, TRANSMISSION AND REAR AXLE)

(Consult GVWR Selector and Tire Chart to insure tire capacity and availability)

ENGINE	TRANSMISSION		AXLES				GVWR
	4-SP	AUTO	2.73	3.08	3.42	3.73	

W/NA5 STANDARD or NA6 HIGH ALTITUDE EMISSIONS

LE9 V8 5.0 Liter (305-4BBL)	MM4	%GQ1	%GU4	—	#GT4	6100
		%GQ1	%GU4	—	*GT4	6100
LH6 Diesel 6.2 Liter V8 (379 Cu. In.)(Reqs B3J)	MXO	—	GQ1	GU6	*GT4	61/6250

W/YF5 CALIFORNIA EMISSION REQUIREMENTS

LS9 V8 5.7 Liter (350-4BBL)	MXO	GQ1	GU4	—	—	6100
LH6 Diesel 6.2 Liter V8 (379 Cu.In.)(Reqs B3J)	MXO	—	GQ1	GU6	—	61/6250

#Reqs NA6 High Altitude Emissions

*Reqs Z82 Trailering Special or NA6 High Altitude Emission

%W/NA6 High Altitude Emissions Base Rear Axle is 3.08.

2.73 Rear Axle is Not Available

GVWR SELECTOR

Minimum Equipment Required For GVW Rating

GVW Rating (lbs)	# GAWR (lbs)		Tire Capacities (lbs each)		Chassis Equipment
	Front	Rear	Front	Rear	
6100	3166	3166	1583	1583	None
✓ 6250	3550	3550	1775	1775	Reqs B3J

#GAWR'S shown are the maximum for each axle with equipment listed. Other GAWR'S are available, and they are determined as the minimum capacity of either axle, springs or tires.

CAPACITIES

SPRINGS:		AXLES:	
Front		Front	
3300	w/o B3J		
3700	w/B3J	3600	Base
4500	w/F60		
Rear		Rear	
3750	Base	3750	Base

TIRES (Must Order Matching Front and Rear Tread and Spare)

Description	Capacity (lbs ea)	Highway		On-Off Road		
		Front	Rear	Front	Rear	Spare
TUBELESS Steel Belted Radial						
P215/75R15	1583	XKT	YKT			ZKT
P235/75R15	1843	XBD	YBD			ZBD
P235/75R15	1843			XES	YES	ZES
P235/75R15 W/W	1843	XBJ	YBJ			ZBJ
P235/75R15 W/L	1843	XWV	YWV			ZWV
✓ *31x10.50R/15 B	1775			XUY	YUY	ZUY
✓ *31x10.50R/15 B W/L	1775			XUZ	YUZ	ZUZ

*Reqs N67 or PA6 Wheels

QUICK-SPEC (OPTIONAL)

EMISSION, ENGINE, TRANSMISSION, AXLE AND TIRES <i>MUST BE</i> ENTERED AS ADDITIONS TO THESE QUICK-SPECS		K 5 A 1	K 5 A 2	K 5 A 3
Air Conditioning: Front	C60	x	x	x
Body: White Hard Top (Z59 Black Hard Top may be substituted)	Z58	x	x	x
Gages: Voltmeter, Temperature and Oil Pressure	Z53	x	x	x
Lighter, Cigarette	U37	x	x	x
Mirrors: Below-Eye-Line, Stainless Steel	D45	x	x	x
Radio: AM	U63	x	N/I	N/I
Seat: Rear	AM7	x	x	x
Radio: AM/FM Stereo	U58		x	N/I
Silverado	YE9		x	x
Speed Control, Electronic	K34		x	x
Steering Wheel: Comfortilt	N33		x	x
Tank, Fuel	NK7		x	x
Wheels: Rally	N67		x	x
Window: Power Tailgate	A33		x	x
Windshield Wiper System: Intermittent	CD4		x	x
Clock: Quartz Electric	U35			x
Floor Covering: Mats, Color-Keyed. Front Only	B32			x
Glass: Deep Tinted w/Light Tinted RR Window	AA3			x
Glass: Window Sliding Side Quarter	AD5			x
Headlamps: Halogen Hi-Beam	TT5			x
Operating Convenience Package	ZQ2			x
Radio: AM/FM Stereo w/Stereo Cassette Tape	UN3			x
Shield, Fuel Tank	NY1			x

PLEASE REVIEW OPTION RESTRICTIONS BEFORE ORDERING

Q-S OPTION

___	K46	AIR CLEANER, PRE-CLEANER
(1)	C60	AIR CONDITIONING: (N/A V10 Cold-Climate) (Incls K81 Gen)
___	V22	APPEARANCE, DELUXE FRONT: (Incl w/YE9 Silverado)
___	G80	AXLE, REAR: Locking Differential
___	UA1	BATTERY: Heavy Duty. 515 Cold Cranking Amps Delco Freedom (N/A B3J Diesel Equip) (Incl w/V10 Cold-Climate)
___		BUMPER EQUIPMENT: Chromed
___	VE5	Bumpers, Deluxe Front and Rear (N/A V31 Guards)
___	V31	Guards, Front Bumper
(3)	U35	CLOCK: Quartz Electric (Incls Z53 Gages)
___	V10	COLD-CLIMATE PACKAGE: (N/A B3J Diesel Equip or C60 Air) (Incls UA1 Battery, K05 Block Heater and K81 Gen)
___		COOLER:
___	KC4	Engine Oil (N/A B3J Diesel Equip) (Incl w/Z82 Trailing)
___	V02	Transmission Oil (w/o B3J Diesel Equip Reqs V01 Cooling or C60 Air) (N/A MM4 Trans) (Incl w/Z82 Trailing)
___	V01	COOLING SYSTEM: Radiator, Heavy-Duty (N/A B3J Diesel Equip or C60 Air)
___	AU3	DOOR LOCK SYSTEM, POWER: (Incl w/ZQ2 Conv Pkg)
(3)	B32	FLOOR COVERING: Mats, Color-Keyed. Front Floor Only (Reqs Custom Vinyl or Cloth Seats)
(1)	Z53	GAGES: Voltmeter, Temperature and Oil Pressure (Incl w/YE9 Silverado or U35 Clock)
___	K81	GENERATOR: Delcotron 66-Amp (Incl w/B3J Diesel Equip, Z82 Trailing, C60 Air or V10 Cold-Climate)
___		GLASS:
(3)	AA3	Deep Tinted with Light Tinted Rear Window (N/A AJ1 Glass)
___	AJ1	Deep Tinted
___	UY7	HARNES, WIRING: Trailer, Heavy-Duty. 7-Lead (Incl w/Z82 Trailing)

PLEASE REVIEW OPTION RESTRICTIONS BEFORE ORDERING

Q-S	OPTION	
(3)	TT5	HEADLAMPS: Halogen Hi-Beam (Reqs V22 Appearance or YE9 Silverado)
---	T63	HEADLAMP WARNING BUZZER
---	BB5	HEADLINER, INTERIOR: (Incl w/YE9 Silverado)
---		HEATER:
---	K05	Engine Block (N/A B3J Diesel Equip) (Incl w/V10 Cold-Climate)
---	C42	Front, Heavy Duty (Reqs B3J Diesel Equip) (N/A C60 Air)
(1)	U37	LIGHTER, CIGARETTE: (Incl w/YE9 Silverado)
---		MIRRORS, EXTERIOR: Below-Eye-Line Type
---	D44	Painted
(1)	D45	Stainless Steel
---		MOLDINGS:
---	B84	Body Side, Black (N/A YE9 Silverado, B85 or YG3 Mldgs) (Incl w/YG1 Mldgs, ZY3 or ZY5 Paint)
---	B85	Body Side, Bright (N/A ZY3 or ZY5 Paint, B84 or YG1 Mldgs) (Incl w/YG3 Mldgs or YE9 Silverado)
---	YG1	Custom Package (N/A B85 or YG3 Mldgs) (Incls B84 Mldgs) (Incl w/ZY3 or ZY5 Paint)
---	YG3	Deluxe Package (Incl w/YE9 Silverado) (Incls B85 Mldgs)
---	B93	Guard, Door Edge
(3)	ZQ2	OPERATING CONVENIENCE PACKAGE: (Incls AU3 Door Locks and A31 Windows)
---	B3W	PRELIMINARY PRICE INFORMATION
---		RADIO EQUIPMENT:
(1)	U63	AM Radio
---	U69	AM/FM Radio
(2)	U58	AM/FM Stereo Radio (Reqs YE9 Silverado)
(3)	UN3	AM/FM Stereo Radio w/Stereo Cassette Tape Player (Reqs YE9 Silverado)
---	U76	Windshield Antenna (Incl w/U63, U69, U58 or UN3 Radio)
---		SEATING: Note: One of the following seat options must be specified
(1)	AM7	Rear, Folding, 3-Passenger
---	YG4	Rear Seat Not Desired
(3)	NY1	SHIELD, FUEL TANK: (Incls Protective Shield on Transfer Case)
---	Z75	SHOCKS, FRONT QUAD
(2)	YE9	SILVERADO: (Refer Trim Chart for Trim Availability) (Incls Z53 Gages, BB5 Headliner, V22 Appearance, YG3 Mldgs, B85 Mldgs and U37 Lighter)
(2)	K34	SPEED CONTROL, ELECTRONIC
---	F60	SPRINGS: Front, Heavy-Duty. Capacity 2250-lb each. (Incls HD Front and Rear Shocks) (Recommended for snowplow type usage only)
(2)	N33	STEERING WHEEL: Comfortilt
(2)	NK7	TANK, FUEL: w/o B3J Diesel Equip Approx 31-Gallon Total Vehicle Capacity. w/B3J Diesel Equip Approx 32-Gallon Total Vehicle Capacity
---	V76	TOWING DEVICE: Two Front Tow Hooks
---		TRAILER HITCH:
---	VR2	Deadweight Type (N/A Z82 Trailing)
---	VR4	Weight Distributing Platform Type (Incl w/Z82 Trailing)
---	Z82	TRAILERING SPECIAL EQUIPMENT: Heavy Duty (Reqs 3.42 or 3.73 Rear Axle) (N/A LS9 Eng or MM4 Trans) (w/o B3J Diesel Equip or C60 Air Reqs V01 Rad and Incls K81 Gen) (Incls VR4 Hitch, UY7 Wiring and V02 Trans Oil Cooler)
---	P01	WHEEL TRIM: Wheel Covers
---		WHEELS: (N/A P215/75R15 Tires)
(2)	N67	Rally
---	PA6	Styled
---		WINDOWS:
---	A31	Power Side Door Glass. Electric (Incl w/ZQ2 Conv Pkg)
(2)	A33	Power Tailgate. Electric
(3)	AD5	Sliding Side Quarter
(2)	CD4	WINDSHIELD WIPER SYSTEM: Intermittent

K BLAZER/JIMMY

BLAZER/JIMMY MODEL SELECTOR

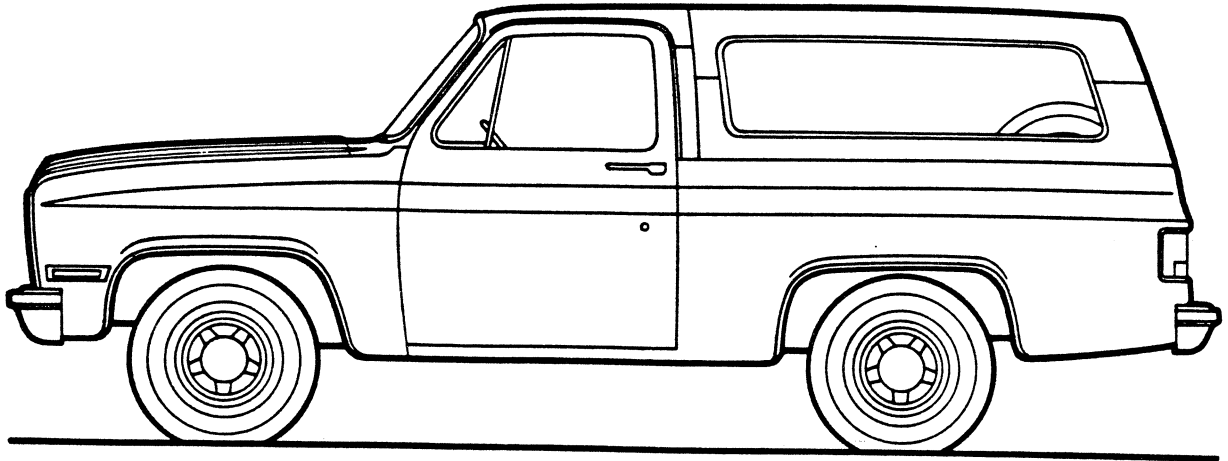

HARDTOP

SERIES	MODEL NUMBER	BODY ORDERING CODE			
		GASOLINE MODELS		DIESEL MODELS	
		WHITE TOP	BLACK TOP	WHITE TOP	BLACK TOP
K10/1500 (4X4)	K10516	Z58	Z59	Z58/B3J	Z59/B3J

GASOLINE

K BLAZER/JIMMY

STANDARD SPECIFICATIONS

(See Gray Tab Section for Specification Details)

Series	K10/1500
Engine Base Equip. Clutch Air Filter Oil Filter Exhaust System Emission Control Systems	5.0 Liter, 305 4-bbl V8 11"; 124 sq. in. Oiled-paper Element Throwing Type Single; Aluminized See Engine & Cooling Section for specific model applications
Suspension, Front Type Axle Capacity Axle Ratio Springs @ Ground Shock Absorbers Stabilizer Bar Hubs - Automatic Locking	Hypoid Driving Axle Leaf Springs 3600 lb. 2.73 1650 lb. ea. 25mm dia. 1.25" dia. Standard
Suspension, Rear Type Axle Capacity Axle Ratio Springs @ Ground Shock Absorbers	Salisbury Axle; Hypoid Drive; Two-stage Multi-leaf Springs Leaf Springs 3750 lb. 2.73 1875 lb. ea. 25mm dia.
Brakes Front Rear Booster Parking	Hydraulic; Self-adjusting Disc; 11.86" Rotor Drum; 11.15" x 2.75" Dual Diaphragm Cable to Rear Wheels
Electrical Battery - Freedom Type - Reserve Capacity Delcotron Generator	12 Volt; Negative Ground 405 CCA ♦ @ 0°F. 75 min. @ 80°F. 37 amp.
Frame Section Modulus	Carbon Steel; 36,-39,000 psi 3.14
Fuel Tank (nominal capacity)	25 gal.
Steering Gear Type	Integral Power
Transmission Shift Location	4-Speed Manual Floor
Transfer Case Shift Lever	New Process 208 2-Speed Single Lever
Tires	(5) P215/75R15
Wheels	(5) Disc, 15" x 6"

♦ CCA-Cold Cranking Amps

K BLAZER/JIMMY

STANDARD SPECIFICATIONS



(See Gray Tab Section for Specification Details)

Series	K10/1500
Engine Base Equip. Clutch Air Filter Oil Filter Oil Cooler Exhaust System Emission Control Systems	6.2 Liter, 379 Cu. In. V8 Diesel 12"; 150 sq. in. Poly-wrapped, Oiled-paper Element Throwaway Type Standard Dual; Aluminized See Engine & Cooling Section for specific model applications
Suspension, Front Type Axle Capacity Axle Ratio Springs @ Ground Shock Absorbers Stabilizer Bar Hubs - Automatic Locking	Hypoid Driving Axle Leaf Springs 3600 lb. 3.08 1850 lb. ea. 25mm dia. 1.25" dia. Standard
Suspension, Rear Type Axle Capacity Axle Ratio Springs, Main @ Ground Shock Absorbers	Salisbury Axle; Hypoid Drive; Two-stage Multi-leaf Springs Leaf Springs 3750 lb. 3.08 1875 lb. ea. 25mm dia.
Brakes Front Rear Booster Parking	Hydraulic; Self-adjusting Disc; 11.86" Rotor Drum; 11.15" x 2.75" Hydraulic Power Cable to Rear Wheels
Electrical Battery - Freedom Type - Reserve Capacity Delcotron Generator Engine Block Heater	12 Volt; Negative Ground Two; 550 CCA ♦ ea. @ 0°F. 115 min. ea. @ 80°F. 66 amp. 600 watts, 120 volts
Frame Section Modulus	Carbon Steel; 36,39,000 psi 3.14
Fuel Tank (nominal capacity)	27 gal.
Steering Gear Type	Integral Power
Transmission Shift Location	4-Speed Automatic w/Overdrive Steering Column
Transfer Case Shift Lever	New Process 208 2-Speed Single Lever
Tires	(5) P215/75R15
Wheels	(5) Disc, 15" x 6"

♦ CCA-Cold Cranking Amps

GASOLINE

K BLAZER/JIMMY

Body Ordering Code:
White Top—Z58; Black Top—Z59

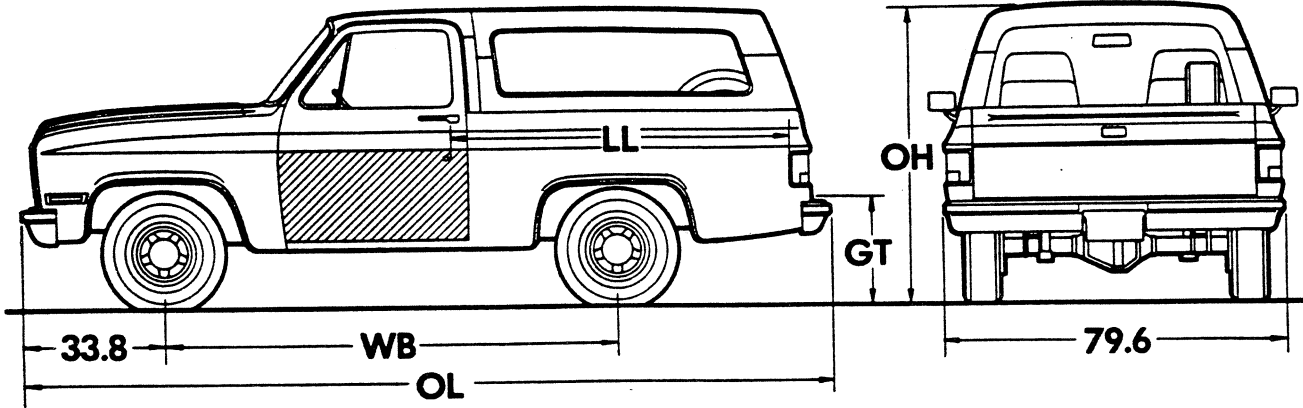

Sign Panel Area (side)
22" x 39½"

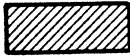

Series	Ground Clearance (in)★	
	Front	Rear
K1	6.9	7.1

K10/1500 SERIES

Model	Engine No. Cyl.	Dimensions (in)★					Curb Weight (lb)			Model Weight (lb)*		
		WB	LL	OL	OH	GT	Front	Rear	Total	Front	Rear	Total
K10516	8	106.5	76.6	184.8	73.8	32.1	2357	2105	4462	2490	2272	4762

★Dimensions with standard equipment, unloaded.

*Model Weight includes Curb Weight plus occupants (standard seating capacity x 150 lb). Total Model Weight may vary as much as ± 50 lbs. to allow for production build variation.

K BLAZER/JIMMY

DIESEL

Body Ordering Code:
White Top—Z58/B3J; Black Top—Z59/B3J

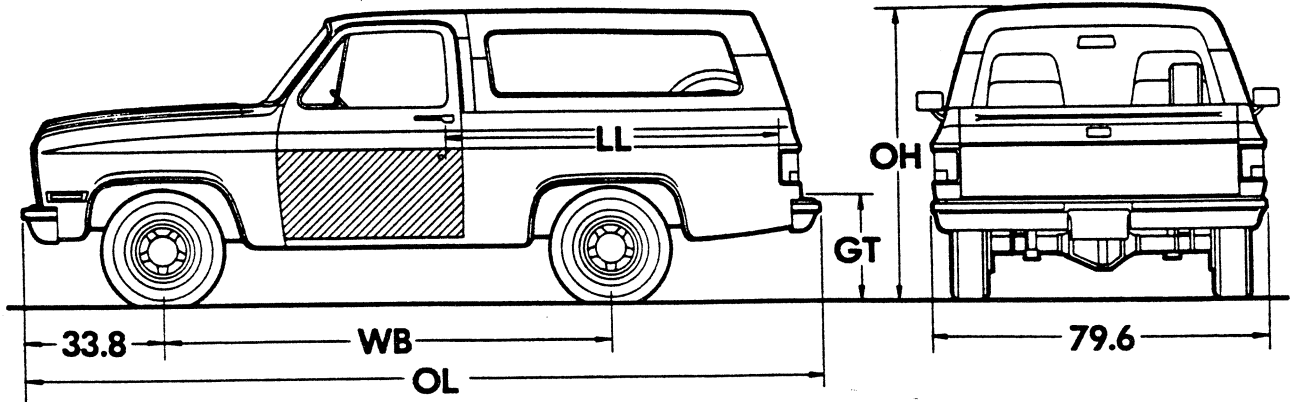

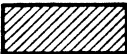
Sign Panel Area (side)
22" x 39½" 

Series	Ground Clearance (in)*	
	Front	Rear
K1	6.9	7.1

K10/1500 SERIES

Model	Engine No. Cyl.	Dimensions (in)*					Curb Weight (lb)			Model Weight (lb)*		
		WB	LL	OL	OH	GT	Front	Rear	Total	Front	Rear	Total
K10516	8	106.5	76.6	184.8	73.8	32.1	2663	2182	4845	2796	2349	5145

*Dimensions with standard equipment, unloaded.

*Model Weight includes Curb Weight plus occupants (standard seating capacity x 150 lb). Total Model Weight may vary as much as ± 50 lbs. to allow for production build variation.

K BLAZER/JIMMY

POWER TEAMS—ALL STATES

POWER TEAMS (MUST ORDER ENGINE, TRANSMISSION AND REAR AXLE) (Consult GVWR Selector and Tire Chart to insure tire capacity and availability)

ENGINE	TRANSMISSION		AXLES				GVWR
	4-SP	AUTO	2.73	3.08	3.42	3.73	
W/NA5 STANDARD or NA6 HIGH ALTITUDE EMISSIONS							
LE9 V8 5.0 Liter (305-4BBL)	MM4		%GQ1	%GU4	—	#GT4	6100
		MX0	%GQ1	%GU4	—	*GT4	6100
LH6 Diesel 6.2 Liter V8 (379 Cu. In.)(Reqs B3J)		MX0	—	GQ1	GU6	*GT4	61/6250
W/YF5 CALIFORNIA EMISSION REQUIREMENTS							
LS9 V8 5.7 Liter (350-4BBL)		MX0	GQ1	GU4	—	—	6100
LH6 Diesel 6.2 Liter V8 (379 Cu.In.)(Reqs B3J)		MX0	—	GQ1	GU6	—	61/6250

#Reqs NA6 High Altitude Emissions

*Reqs Z82 Trailering Special or NA6 High Altitude Emission

%W/NA6 High Altitude Emissions Base Rear Axle is 3.08.

2.73 Rear Axle is Not Available

ENGINE RATINGS

ALL STATES EXCEPT CALIFORNIA

SAE Net Ratings	5.0 Liter 305 4-bbl V8	6.2 Liter 379 V8 Diesel
Net Horsepower . .	160 @ 4400 rpm	130 @ 3600 rpm
Net Torque, lb-ft . .	235 @ 2000 rpm	240 @ 2000 rpm

CALIFORNIA ONLY

SAE Net Rating	5.7 Liter 350 4-bbl V8	6.2 Liter 379 V8 Diesel
Net Horsepower . .	165 @ 3800 rpm	130 @ 3600 rpm
Net Torque, lb-ft . .	275 @ 1600 rpm	240 @ 2000 rpm

K BLAZER/JIMMY

GVWR SELECTOR—ALL STATES

K10/1500 SERIES

GVW Rating (lbs)	†GAWR (lbs)		Minimum Equipment Required for GVW Rating			
	Front	Rear	Tire Capacity (lbs ea)		Chassis Equipment	
			Front	Rear		
6100	3166	3166	1583	1583	Standard	
■6250	3550	3550	1775	1775	Standard	

†GAWR's shown are the maximum for each axle with equipment listed. Other GAWR's are available, and they are determined as the minimum capacity of either axle, springs or tires.

■Diesel engine models only.

FRONT AND REAR TIRE AVAILABILITY CHART—ALL STATES

K10/1500 SERIES

Spare tire to match either front or rear tires must be ordered
Must order matching front and rear tread

Description	Capacity (lbs ea)	Highway		On-Off Road		Spare
		Front	Rear	Front	Rear	
TUBELESS						
P215/75R15 Steel Belted Radial	1583	XKT	YKT	—	—	ZKT
P235/75R15 Steel Belted Radial	1843	XBD —	YBD —	— XES	— YES	ZBD ZES
P235/75R15 Whitewall Steel Belted Radial	1843	XBJ	YBJ	—	—	ZBJ
P235/75R15 White Lettered Steel Belted Radial	1843	XWV	YWV	—	—	ZWV
*31 x 10.50R15LT/B Steel Belted Radial	1775	—	—	XUY	YUY	ZUY
*31 x 10.50R15LT/B White Lettered Steel Belted Radial	1775	—	—	XUZ	YUZ	ZUZ

*Requires N67 or PA6 wheels.

K BLAZER/JIMMY

THE FOLLOWING EQUIPMENT IS STANDARD ON DIESEL ENGINE MODELS (ALSO SEE STANDARD SPECIFICATIONS PAGES)

- Low Coolant Sensor
- Poly-wrapped Paper Element Air Cleaner
- Engine Block Heater
- Power Steering
- MXO 4-speed Automatic Transmission (with over-drive)
- Water/fuel separator unit which incorporates a water sensor and sending unit, a fuel filter, a fuel heater and water drain capability
- Hydraulic Power-assisted Brakes
- K81 66-amp Generator
- Engine Oil Cooler (located in radiator tank)
- Dual 550 Cold Cranking Amp/115 min. Reserve Capacity Batteries
- HD Radiator
- Dual Exhaust System
- Additional Insulation:
 - Cab-to-fender insulators
 - Fiberglass hood insulator
 - Fiberglass engine compartment firewall insulator
 - Cowl side spray-on deadener
 - Driver compartment dash mat with increased mastic layer
 - Resinated cotton and mastic floor insulation
 - Full cowl interior trim panels with resinated cotton insulation
- Warning Lights: Glow Plugs, Water-in-fuel (or fuel filter), and Low Coolant
- Diesel Engine Identification:
 - Hood ornament
 - Fender nameplates
 - Tailgate nameplate
 - "Diesel Fuel Only" filler cap and label
- HD (1850-lb. ea.) Front Springs

K BLAZER/JIMMY

1984 VEHICLES WITH STANDARD EQUIPMENT

Prices shown are effective with vehicles produced on and after February 13, 1984

Description	Model Number	Body Code	Wheel Base	Factory D&H(a)	List Price	Mfr's Suggested Retail Price★	Group Number
◆ 8-Cylinder 5.0 Liter (305 Cu. In.) 4 BBL V8 Gasoline Engine-Engine Ordering Code LE9							
K10/K1500 Series 4-Wheel Drive							
Utility (White Hard Top)	CK/TK10516	Z58	106.5"	N.A.	10819.00	10819.00	14
Utility (Black Hard Top)	CK/TK10516	Z59	106.5"	N.A.	10819.00	10819.00	14
◆ 8-Cylinder 6.2 Liter (379 Cu. In.) L.D. Diesel V8 Engine-Engine Ordering Code LH6							
K10/K1500 Series 4-Wheel Drive							
Utility (White Hard Top)	CK/TK10516	Z58 & B3J	106.5"	N.A.	13552.00	13552.00	14
Utility (Black Hard Top)	CK/TK10516	Z59 & B3J	106.5"	N.A.	13552.00	13552.00	14

★ Manufacturer's Suggested Retail Prices do not include applicable destination charges, state and local taxes, license fees, optional equipment or accessories or special items or services.

◆ Refer to Dealer Order Guide for California Requirements.

OPTIONS AND ACCESSORIES WHEN INSTALLED BY GENERAL MOTORS

Prices shown are effective with vehicles produced on and after February 13, 1984

Description	Option Number	Factory D&H(a)	List Price	Mfr's Suggested Retail Price◇
Silverado/Sierra Classic: (See Interior and Exterior Color Selection Chart) With custom cloth or custom vinyl seats only. Includes custom steering wheel, YG3 Deluxe Molding Package, taillight and rear door or tailgate moldings, bright front turn signal and front side marker lamp bezels, fender nameplates, bright windshield and rear side window moldings, color-keyed carpeting with bright sill plates, plastic door trim panels with storage pockets and bright brushed-finish accents, visor vanity mirror, V22 Deluxe Front Appearance, dual horns, nameplate on instrument panel, U37 Cigarette Lighter, B85 Headliner, wheel opening moldings, special insulation, B85 Bright Body Side Moldings, pillar trim panels, stowage console between front seats, floor and wheelhouse carpeting, spare tire cover and Z53 Voltmeter, Temperature and Oil Pressure Gages	YE9	N.A.	983.00	983.00
Seat Trim: High Back Bucket Seats Driver and Passenger. (See Interior and Exterior Color Selection Chart for availability and ordering information.)				
V**4 Vinyl Bucket. Not available when YE9 is specified.			NO ADDITIONAL CHARGE
X**4 Custom Vinyl Bucket. Includes color-keyed carpeting.				
Without YE9. Includes stowage console between front seats.				
Without AM7 Rear Seat	N.A.	200.00	200.00
With AM7 Rear Seat	N.A.	250.00	250.00
With YE9.				
Without AM7 Rear Seat			NO ADDITIONAL CHARGE
With AM7 Rear Seat	N.A.	50.00	50.00
L**4 Custom Cloth Bucket. Available only when YE9 is specified.				
Without AM7 Rear Seat			NO ADDITIONAL CHARGE
With AM7 Rear Seat	N.A.	50.00	50.00
Paints, Exterior: (See Interior and Exterior Color Selection Chart for Ordering Information and Paint Application).				
Solid	ZY1			NO ADDITIONAL CHARGE
Special Two-Tone.				
Without YE9. Includes YG1 Custom Molding Package and wheel opening moldings	ZY3	N.A.	317.00	317.00
With YE9	ZY3	N.A.	165.00	165.00
Exterior Decor Package. Includes hood ornament.				
Without YE9. Includes YG1 Custom Molding Package and wheel opening moldings	ZY5	N.A.	456.00	456.00
With YE9	ZY5	N.A.	304.00	304.00

(a) D & H Charges on vehicle and optional equipment include reimbursement to ordering Division for any tax that it has paid, incurred or agreed to pay thereon.

◇ State and local taxes not included.

K BLAZER/JIMMY

OPTIONS AND ACCESSORIES WHEN INSTALLED BY GENERAL MOTORS

Prices shown are effective with vehicles produced on and after February 13, 1984

Description	Option Number	Factory D&H(a)	List Price	Mfr's Suggested Retail Price◇
Emission Systems: Dealer Note – One of the following emission options must be specified.				
<i>California Emission Requirements: (See Power Teams Charts for availability and complete specifications)</i> Includes all testing, equipment and/or certification necessary for registration in the State of California. Not available when NA6 High Altitude or NA5 Standard Emissions is specified.				
Without B3J Diesel Equipment	YF5	N.A.	235.00	235.00
With B3J Diesel Equipment	YF5	N.A.	235.00	235.00
<i>High Altitude Emission Equipment.</i> Not available when YF5 California Emissions or NA5 Standard Emission Equipment is specified				
Standard Emission Equipment	NA6	NO ADDITIONAL CHARGE		
	NA5	NO ADDITIONAL CHARGE		
Engines: (See Power Teams Chart for availability and complete specifications)				
<i>Gasoline.</i>				
5.0 Liter (305 Cu. In.) 4 BBL V8	LE9	NO ADDITIONAL CHARGE		
5.7 Liter (350 Cu. In.) 4 BBL V8. Available only when YF5 California Emissions is specified	LS9	N.A.	181.00	181.00
<i>Diesel.</i>				
6.2 Liter (379 Cu. In.) L.D. V8 Diesel. Available only when B3J Diesel Equipment and MX0 Automatic Transmission are specified	LH6	NO ADDITIONAL CHARGE		
Transmissions: (See Power Teams Chart for availability and complete specifications)				
<i>4-Speed Manual.</i> Not available when B3J Diesel Equipment or LS9 5.7 Liter Engine is specified				
4-Speed Automatic with Overdrive. Included when B3J Diesel Equipment is specified.	MM4	NO ADDITIONAL CHARGE		
	MX0	N.A.	650.00	650.00
Axles: (See Power Teams Chart for availability and complete specifications)				
Optional Ratio	N.A.	36.00	36.00
Locking Differential	G80	N.A.	230.00	230.00
Tires: (See Tire Charts for Tire Availability)				
<i>All rim sizes are 6.00" except when N67 and PA6 Wheels are specified.</i>				
TUBELESS				
<i>P215/75R15 Highway Steel Belted Radial Ply Blackwall (Maximum Capacity 1583 lbs)</i>				
Front (Standard)	XKT	NO ADDITIONAL CHARGE		
Rear (Standard)	YKT	NO ADDITIONAL CHARGE		
Spare (Standard)	ZKT	NO ADDITIONAL CHARGE		
<i>P235/75R15 Highway Steel Belted Radial Ply Blackwall (Maximum Capacity 1843-lbs)</i>				
Front	XBD	N.C.	50.00	50.00
Rear	YBD	N.C.	50.00	50.00
Spare	ZBD	N.C.	25.00	25.00
<i>P235/75R15 On-Off Road Steel Belted Radial Ply Blackwall (Maximum Capacity 1843-lbs)</i>				
Front	XES	N.C.	70.00	70.00
Rear	YES	N.C.	70.00	70.00
Spare	ZES	N.C.	35.00	35.00
<i>P235/75R15 Highway Steel Belted Radial Ply Whitewall (Maximum Capacity 1843-lbs)</i>				
Front	XBJ	N.C.	84.00	84.00
Rear	YBJ	N.C.	84.00	84.00
Spare	ZBJ	N.C.	42.00	42.00
<i>P235/75R15 Highway Steel Belted Radial Ply White Lettered (Maximum Capacity 1843-lbs)</i>				
Front	XWV	N.C.	96.00	96.00
Rear	YWV	N.C.	96.00	96.00
Spare	ZWV	N.C.	48.00	48.00

(a) D & H Charges on vehicle and optional equipment include reimbursement to ordering Division for any tax that it has paid, incurred or agreed to pay thereon.
 ◇ State and local taxes not included.

K BLAZER/JIMMY

OPTIONS AND ACCESSORIES WHEN INSTALLED BY GENERAL MOTORS

Prices shown are effective with vehicles produced on and after February 13, 1984

Description	Option Number	Factory D&H(a)	List Price	Mfr's Suggested Retail Price◇
Tires: (Continued)				
10R/15LTB On-Off Road Steel Belted Radial Ply Blackwall (Maximum Capacity 1760-lbs)				
Available only when N67 or PA6 Wheels are specified				
Front	XXM	2.16	226.00	228.16
Rear	YXM	2.16	226.00	228.16
Spare	ZXM	1.08	113.00	114.08
10R/15LTB On-Off Road Steel Belted Radial Ply White Lettered (Maximum Capacity 1760-lbs)				
Available only when N67 or PA6 Wheels are specified.				
Front	XXN	2.16	288.00	290.16
Rear	YXN	2.16	288.00	290.16
Spare	ZXN	1.08	144.00	145.08
31 x 10.50R/15LTB On-Off Road Steel Belted Radial Ply Blackwall. (Maximum Capacity 1775-lbs)				
Available only when N67 on PA6 Wheels are specified				
Front	XUY	2.16	226.00	228.16
Rear	YUY	2.16	226.00	228.16
Spare	ZUY	1.08	113.00	114.08
31 x 10.50R/15LTB On-Off Road Steel Belted Radial Ply White Lettered. (Maximum Capacity 1775-lbs)				
Available only when N67 or PA6 Wheels are specified				
Front	XUZ	2.16	288.00	290.16
Rear	YUZ	2.16	288.00	290.16
Spare	ZUZ	1.08	144.00	145.08

OTHER OPTIONS

Air Cleaner, Pre-Cleaner	K46	N.A.	41.00	41.00
Air Conditioning: All-Weather. Not available when V10 Cold-Climate Package is specified. Includes extra cooling.				
Without B3J Diesel Equipment. Also includes K81 66-Amp Generator				
.....	C60	N.A.	730.00	730.00
With B3J Diesel Equipment	C60	N.A.	670.00	670.00
Appearance, Deluxe Front: Includes dark argent grille with bright trim and dual rectangular headlamps. Included when YE9 is specified				
.....	V22	N.A.	106.00	106.00
Battery: Heavy-Duty. 515 Cold Cranking Amps Delco Freedom. Not available when B3J Diesel Equipment is specified. Included when V10 Cold-Climate Package is specified				
.....	UA1	N.A.	50.00	50.00
Bumper Equipment:				
Bumpers, Deluxe Chromed. Front and Rear. Not available when V31 Bumper Guards are specified. Includes black resilient impact strips				
.....	VE5	N.A.	47.00	47.00
Guards, Chromed. Front Bumper	V31	N.A.	40.00	40.00
Clock: Quartz Electric				
Without YE9. Includes Z53 Voltmeter, Temperature and Oil Pressure Gages				
.....	U35	N.A.	76.00	76.00
With YE9	U35	N.A.	38.00	38.00
Cold-Climate Package: Not available when C60 Air Conditioning or B3J Diesel Equipment is specified. Includes special insulation special heater and defroster, K05 Engine Block Heater, anti-freeze protection to -32 degrees and UA1 H.D. Battery.				
Without Z82 Trailing Special. Also includes K81 66-Amp Generator				
.....	V10	N.A.	180.00	180.00
With Z82 Trailing Special	V10	N.A.	120.00	120.00
Coolers:				
Engine Oil. Not available when B3J Diesel Equipment is specified. Included when Z82 Trailing Special is specified				
.....	KC4	N.A.	116.00	116.00
Transmission Oil. Not available when MM4 4-Speed Transmission is specified. Included when Z82 Trailing Special is specified. Without B3J Diesel Equipment requires V01 H.D. Cooling or C60 Air Conditioning				
.....	V02	N.A.	57.00	57.00

(a) D & H Charges on vehicle and optional equipment include reimbursement to ordering Division for any tax that it has paid, incurred or agreed to pay thereon.

◇ State and local taxes not included.

K BLAZER/JIMMY

OPTIONS AND ACCESSORIES WHEN INSTALLED BY GENERAL MOTORS

Prices shown are effective with vehicles produced on and after February 13, 1984

Description	Option Number	Factory D&H(a)	List Price	Mfr's Suggested Retail Price◇
OTHER OPTIONS				
Cooling System: Radiator, Heavy-Duty. Not available when C80 Air Conditioning or B3J Diesel Equipment is specified	V01	N.A.	51.00	51.00
Door Lock System, Power: Included when ZQ2 Operating Convenience Package is specified	AU3	N.A.	130.00	130.00
Floor Covering: Mats, Color-Keyed, Front Floor. Available only when Custom Vinyl or Cloth Interior is specified	B32	N.A.	14.00	14.00
Gages: Voltmeter, Temperature and Oil Pressure. Included when YE9 or U35 Electric Clock is specified	Z53	N.A.	38.00	38.00
Generator: 66-Amp Delcotron. Included when B3J Diesel Equipment, Z82 Trailing Special, V10 Cold-Climate Package or C60 Air Conditioning is specified	K81	N.A.	60.00	60.00
Glass:				
<i>Deep Tinted.</i> Includes dark laminated glass on side windows and rear tailgate glass	AJ1	N.A.	187.00	187.00
<i>Deep Tinted with Light Tinted Rear Window.</i> Includes tinted glass on rear tailgate glass, passenger and driver's side door. Also includes dark laminated glass on side windows. Included when AJ1 Deep Tinted Glass is specified	AA3	N.A.	133.00	133.00
Harness, Wiring: Trailer, Heavy-Duty, 7-lead. Included when Z82 Trailing Special is specified	UY7	N.A.	43.00	43.00
Headlamps: Halogen Hi-Beam. Available only when V22 Deluxe Front Appearance Package or YE9 is specified.	TT5	N.A.	16.00	16.00
Headlamp Warning Buzzer	T63	N.A.	11.00	11.00
Headliner, Interior: Included when YE9 is specified ...	BB5	N.A.	77.00	77.00
Heaters:				
<i>Engine Block. 600 Watts, 120 Volts.</i> Not available when B3J Diesel Equipment is specified. Included when V10 Cold-Climate Package is specified	K05	N.A.	31.00	31.00
<i>Heavy Duty, Front.</i> Available only when B3J Diesel Equipment is specified. Not available when C80 Air Conditioning is specified	C42	N.A.	42.00	42.00
Lighter, Cigarette: Included when YE9 is specified	U37	N.A.	29.00	29.00
Mirrors, Exterior: LH and RH				
<i>Below-Eye-Line Type. 9" x 6.5".</i>				
<i>Painted</i>	D44	N.A.	48.00	48.00
<i>Stainless Steel</i>	D45	N.A.	78.00	78.00
Moldings:				
<i>Body Side, Black.</i> Bright with black insert. Not available when B85 Bright Body Side Moldings, YG3 Deluxe Molding Package or YE9 is specified. Includes lower side and rear moldings of black plastic with bright trim. Included when YG1 Custom Molding Package, ZY3 Special Two-Tone Paint or ZY5 Exterior Decor Package is specified	B84	N.A.	111.00	111.00
<i>Body Side, Bright.</i> Not available when ZY3 Special Two-Tone Paint, ZY5 Exterior Decor Package, B84 Black Body Side Moldings or YG1 Custom Molding Package is specified. Includes bright plastic body side and rear lower moldings with black paint trim, plus bright trim for front side marker lights and taillights, fender, door, rear side panel and tailgate moldings. Included when YG3 Deluxe Molding Package or YE9 is specified	B85	N.A.	139.00	139.00
<i>Custom Package.</i> Not available when B85 Bright Body Side Moldings or YG3 Deluxe Molding Package is specified. Included when ZY3 Special Two-Tone Paint or ZY5 Exterior Decor Package is specified. Includes B84 Black Body Side Moldings, wheel opening moldings and bright trim for front side marker lamps and taillight trim	YG1	N.A.	152.00	152.00

(a) D & H Charges on vehicle and optional equipment include reimbursement to ordering Division for any tax that it has paid, incurred or agreed to pay thereon.
 ◇ State and local taxes not included.

K BLAZER/JIMMY

OPTIONS AND ACCESSORIES WHEN INSTALLED BY GENERAL MOTORS

Prices shown are effective with vehicles produced on and after February 13, 1984

Description	Option Number	Factory D&H(a)	List Price	Mfr's Suggested Retail Price◇
OTHER OPTIONS				
Moldings: (Continued)				
<i>Deluxe Package.</i> Included when YE9 is specified. Includes bright trim for front side marker lamps and taillight trim, wheel opening moldings and B85 Bright Body Side Moldings.				
Without ZY3 Special Two-Tone Paint or ZY5 Exterior Decor Package	YG3	N.A.	167.00	167.00
With ZY3 Special Two-Tone Paint or ZY5 Exterior Decor Package	YG3	N.A.	15.00	15.00
Guards, Door Edge	B93	N.A.	16.00	16.00
Operating Convenience Package: Includes AU3 Power Door Lock System and A31 Power Windows				
	ZQ2	N.A.	310.00	310.00
Preliminary Price Information				
	B3W	N.A.	N.A.	N.A.
Radio Equipment:				
AM Radio	U63	N.A.	112.00	112.00
AM/FM Radio	U69	N.A.	171.00	171.00
AM/FM Stereo Radio. Available only when YE9 is specified	U58	N.A.	198.00	198.00
AM/FM Stereo Radio with Stereo Cassette Tape. Available only when YE9 is specified	UN3	N.A.	298.00	298.00
Windshield Antenna. Included when U63, U69, U58 or UN3 Radio is specified	U76	N.A.	31.00	31.00
Seats: Dealer Note - AM7 Rear Seat or YG4 Rear Seat Not Desired must be specified. (Added weight includes passenger weight allowance of 150-lbs per seating position. Refer to vehicle and option weight section of Data Book.)				
<i>Rear, 3-Passenger.</i> Forward Folding. Seat trim matches front seat. Includes LH and RH rear armrests with ashtrays, floor covering, floor insulation and (3) seat belts. With standard front seat also includes black embossed rubber rear floor mats. With custom seats or YE9 also includes color-keyed rear floor carpeting.				
Without Custom Trim	AM7	N.A.	330.00	330.00
With Custom Trim. Also includes wheelhouse carpeting	AM7	N.A.	358.00	358.00
Optional Seat Not Desired	YG4	NO ADDITIONAL CHARGE		
Shield, Fuel Tank: Includes protective shield transfer case skid plate				
	NY1	N.A.	159.00	159.00
Shocks, Front Quad: Includes dual left and right hand shock absorbers on front, heavy-duty shock absorbers on rear and a front axle nose bumper to limit axle windup				
	Z75	N.A.	123.00	123.00
Speed Control, Electronic				
	K34	N.A.	185.00	185.00
Springs: Front, Heavy-Duty. Capacity 2250-lb each. Includes H.D. front and rear shock absorbers. Recommended for snowplow type usage only.				
Without Z75 Front Quad Shocks	F60	N.A.	89.00	89.00
With Z75 Front Quad Shocks	F60	N.A.	57.00	57.00
Steering Wheel: Comfortilt				
	N33	N.A.	110.00	110.00
Tank, Fuel: Approximately 31-gallon capacity for gasoline and 32-gallon capacity for diesel. Replaces production fuel tank				
	NK7	N.A.	41.00	41.00
Towing Device: Two front towing hooks				
	V76	N.A.	35.00	35.00
Trailer Hitch:				
<i>Deadweight Type.</i> Not available when Z82 Trailing Special is specified				
	VR2	N.A.	56.00	56.00
<i>Weight Distributing Platform Type.</i> Included when Z82 Trailing Special is specified				
	VR4	N.A.	150.00	150.00

(a) D & H Charges on vehicle and optional equipment include reimbursement to ordering Division for any tax that it has paid, incurred or agreed to pay thereon.
 ◇ State and local taxes not included.

K BLAZER/JIMMY

OPTIONS AND ACCESSORIES WHEN INSTALLED BY GENERAL MOTORS

Prices shown are effective with vehicles produced on and after February 13, 1984

Description	Option Number	Factory D&H(a)	List Price	Mfr's Suggested Retail Price◇
OTHER OPTIONS				
Trailer Special: Available only when 3.42 or 3.73 Rear Axle Ratio and MX0 Automatic Transmission are specified. Without B3J Diesel Equipment or C60 Air Conditioning, available only when V01 H.D. Cooling is specified. Not available when LS9 5.7 Liter Engine is specified. Includes VR4 Weight Distributing Hitch Platform, UY7 Wiring Harness and V02 Transmission Oil Cooler. (See Trailing Guide in Recreational Vehicles Section for GCW ratings with available power train combinations).				
Without B3J Diesel Equipment or C60 Air Conditioning. Also includes K81 66-Amp Generator and KC4 Engine Oil Cooler	Z82	N.A.	426.00	426.00
With B3J Diesel Equipment	Z82	N.A.	250.00	250.00
With C60 Air Conditioning. Also includes KC4 Engine Oil Cooler	Z82	N.A.	366.00	366.00
Wheel Trim: Bright Metal Wheel Covers. Front units contain hub clearance holes	P01	N.A.	39.00	39.00
Wheels: Not available when P215 tires are specified.				
<i>Rally.</i> 15" x 8". Includes trim rings	N67	N.A.	109.00	109.00
<i>Styled.</i> 15" x 8" Four wheels only	PA6	N.A.	168.00	168.00
Windows, Power: Electric.				
<i>Side Door.</i> Included when ZQ2 Operating Convenience Package is specified	A31	N.A.	180.00	180.00
<i>Tailgate</i>	A33	N.A.	90.00	90.00
Window, Sliding Side Quarter	AD5	N.A.	235.00	235.00
Windshield Wiper System: Intermittent	CD4	N.A.	50.00	50.00

(a) D & H Charges on vehicle and optional equipment include reimbursement to ordering Division for any tax that it has paid, incurred or agreed to pay thereon.
 ◇ State and local taxes not included.

K BLAZER/JIMMY

**CAB & BODY FEATURES
SEATING ARRANGEMENTS
CAB DIMENSIONS
COLOR & TRIM CHARTS
TWO-TONES**

K BLAZER/JIMMY

CUSTOM DELUXE/SIERRA FEATURES—STANDARD MODEL

The Custom Deluxe/Sierra standard models include the following items as standard equipment

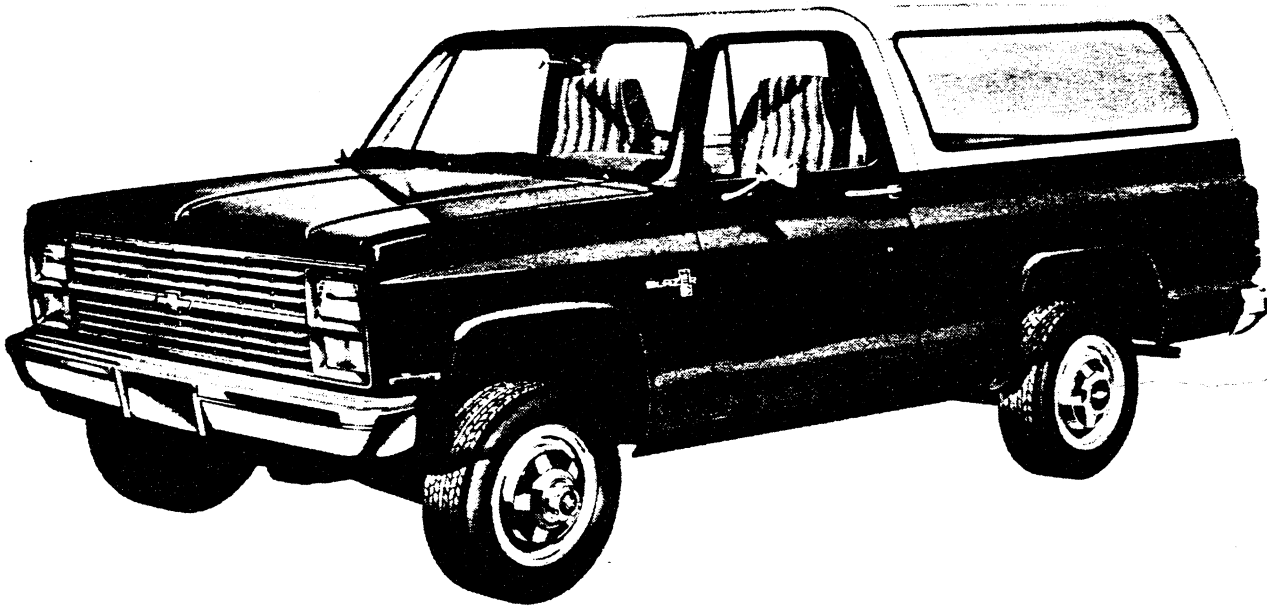

EXTERIOR

- **Bumpers:** Front and rear; chromed
- **Color:** See Interior and Exterior Color Selection Chart
- **Doors:** RH and LH side doors
- **Drip Moldings:** Over side doors; painted roof color
- **Glass:** Tinted; all windows
- **Grille and Headlamp Bezels:** Molded plastic; painted argent; integral Chevrolet emblem/GMC letters at center of grille
- **Horn:** Single, electric low-note
- **Hub Caps:** Bright metal with black trim
- **Keys:** Two-key system with separate keys for ignition switch and doors
- **Lights:**
 - Backup lamps: Two rear (integral with taillamps)
 - Combination parking/direction/hazard: Two front
 - Combination tail/stop/direction/hazard: Two rear
 - Headlamps: Two, rectangular
 - License plate lamp: Single rear
 - Side marker lamps with reflectors: Two front; two rear (integral with taillamps)
- **Mirrors:** RH and LH fixed arm with adjustable 5-7/16" wide x 4" high heads; chrome finish
- **Moldings:** Bright headlamp and grille outline moldings
- **Nameplates:** Bright "K5 Blazer/Jimmy" nameplates on front fenders near doors; and a bright Chevrolet nameplate/GMC letters on tailgate
- **Removable Top:** Constructed of molded plastic reinforced with fiberglass. Included are LH and RH fixed side windows. The exterior of the top is finished with either black or white paint (see Interior and Exterior Color Availability Chart). The cab roof is painted the same color as the removable top.
- **Tailgate:** Double-wall steel construction, supported in open position by reel-type cables. Includes drop glass operated by an articulated crank-type regulator handle on the tailgate outer panel. A key lock cylinder is concealed in the regulator handle, and must be unlocked before the window can be lowered. After the window is lowered, the tailgate is released with a handle located at the upper center of the inner panel. An optional electric tailgate window is available (RPO A33)
- **Tools:** Mechanical jack and wheel wrench
- **Wheels:** Painted white
- **Windshield Wipers and Washers:** Electric, 2-speed wipers with bright finish on exposed metal portions; coordinated dual-orifice washers

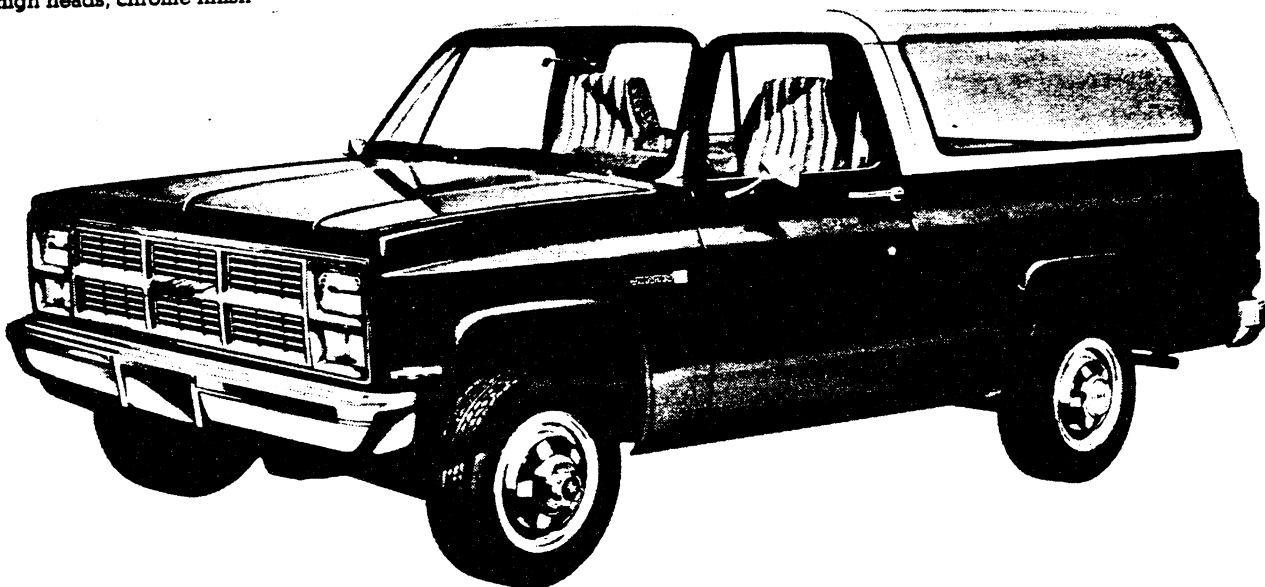

K BLAZER/JIMMY

CUSTOM DELUXE/SIERRA FEATURES—STANDARD MODEL

The Custom Deluxe/Sierra standard models include the following items as standard equipment

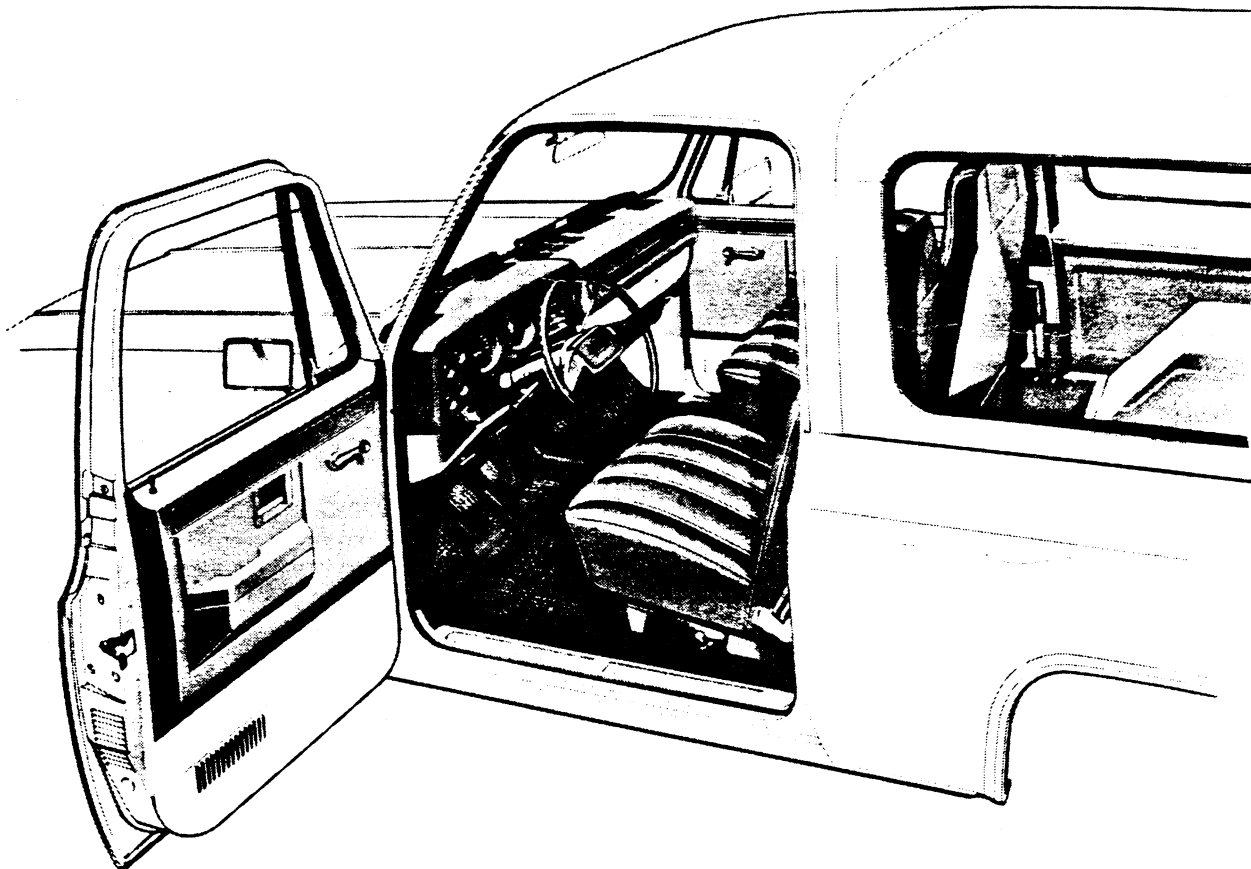

INTERIOR

- **Armrests:** RH and LH padded; integral with door trim panels
- **Ashtray:** In middle of instrument panel
- **Coat Hooks:** Two; on LH side
- **Colors:**
 - Painted body areas: Same as exterior primary color choice
 - Removable top: Mystic
 - Interior trim: Coordinated with seat trim color choice
- **Dome Lamps:** Two; with door-actuated switches (dome lamps may also be activated by main light switch)
- **Door Trim Panels:** Color-keyed, molded plastic
- **Floor Covering:** Embossed black rubber mats; front and rear
- **Heater and Defogger:** Deluxe-air
- **Hood Lock Release:** Handle located on LH side under instrument panel
- **Instrument Cluster Bezel:** Black crackle finish with bright trim
- **Instruments:**
 - Gages: Speedometer, odometer, and fuel
 - Switches: Main, for control of exterior lights, instrument cluster lights, dome light(s) and cab interior lights; multi-function switch on steering column for direction signals by moving lever up or down (includes lane change position), headlamp beams by pulling lever toward driver, windshield wiper by turning band marked "WIPER" toward or away from driver, and windshield washer by pushing in the lever knob; ignition with key-in warning buzzer; hazard warning; heater fan
 - Warning lights: Generator, oil pressure, engine temperature, service-parking brake, direction/hazard signal, seat belt, high beam
- **Instrument Panel Control Knobs:** Soft black plastic (except heater and wiper-washer controls) with white graphic identification
- **Instrument Panel Pad:** Color-keyed, energy-absorbing foam type with grained vinyl skin; has black crackle-finished applique on RH side with bright, black, and silver trim and bright "Custom Deluxe" nameplate
- **Insulation and Sound Deadening Material:** Dash (firewall), under floor mats, and between inner and outer cab roof panels
- **Lights:** Instrument cluster and cab interior lights, cab and removable top dome lights with bright trim
- **Mirror, Rearview:** 10" prismatic with soft vinyl rim
- **Seats:** Driver and passenger; foam-padded high back bucket type with embossed grained all-vinyl trim. See Interior and Exterior Color Selection Chart for color and trim availability
- **Seat Belt:** Driver and passenger; non-detachable combination lap and shoulder belt with emergency-locking retractor and switch in driver's lap belt retractor for buzzer warning system. Belt assembly is color-keyed with pushbutton type buckle
- **Sill Plates:** Full-length, bright, at front doors and at front and rear of rear compartment floor
- **Spare Tire Mounting:** On RH side panel behind wheelhousing
- **Steering Wheel and Column:** 16" black soft plastic wheel with 2-spoke design; black energy-absorbing steering column with anti-theft locking feature
- **Stowage Box:** In RH side of instrument panel; door has bright, turn-type latch release
- **Sunshade:** LH and RH padded; color-keyed

K BLAZER/JIMMY

SILVERADO/SIERRA CLASSIC MODEL OPTION—RPO YE9

This option includes all Custom Deluxe/Sierra standard model items plus the additions or substitutions listed below

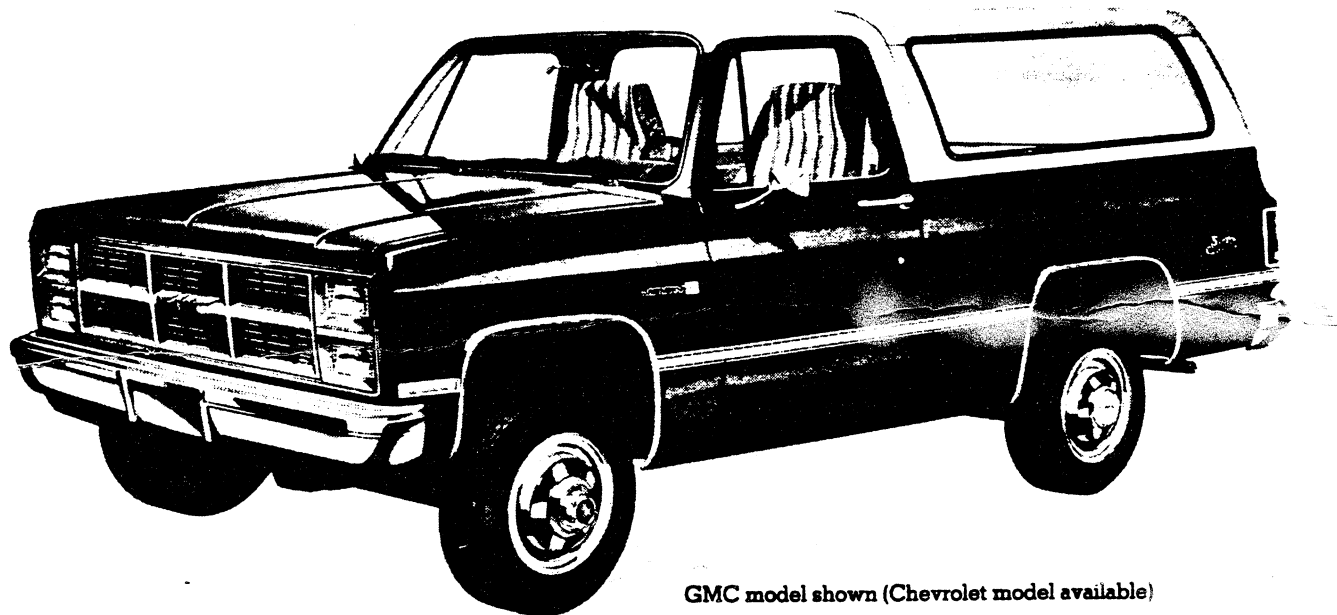

GMC model shown (Chevrolet model available)

EXTERIOR

• Bright Appearance Items:

- Brush-finished applique panel on tailgate
- "Silverado/Sierra Classic" nameplate on each side panel at center rear
- Body side and rear moldings with black paint trim
- Wheel-opening lip moldings with black paint trim
- Front side marker lamp and taillamp trim
- Chrome-trimmed grille and headlamp bezels (Chevrolet models only)

- Chevrolet emblem/GMC letters at grille center
- Removable top side window moldings
- Windshield reveal moldings

- **Cab-to-Fender Insulators**
- **Grille and Headlamp Bezel Paint:** Dark argent (Chevrolet); argent/dark argent (GMC)
- **Hood Insulator**
- **Horn:** Additional, electric, high-note
- **Special Headlamps:** Rectangular; dual RH and LH

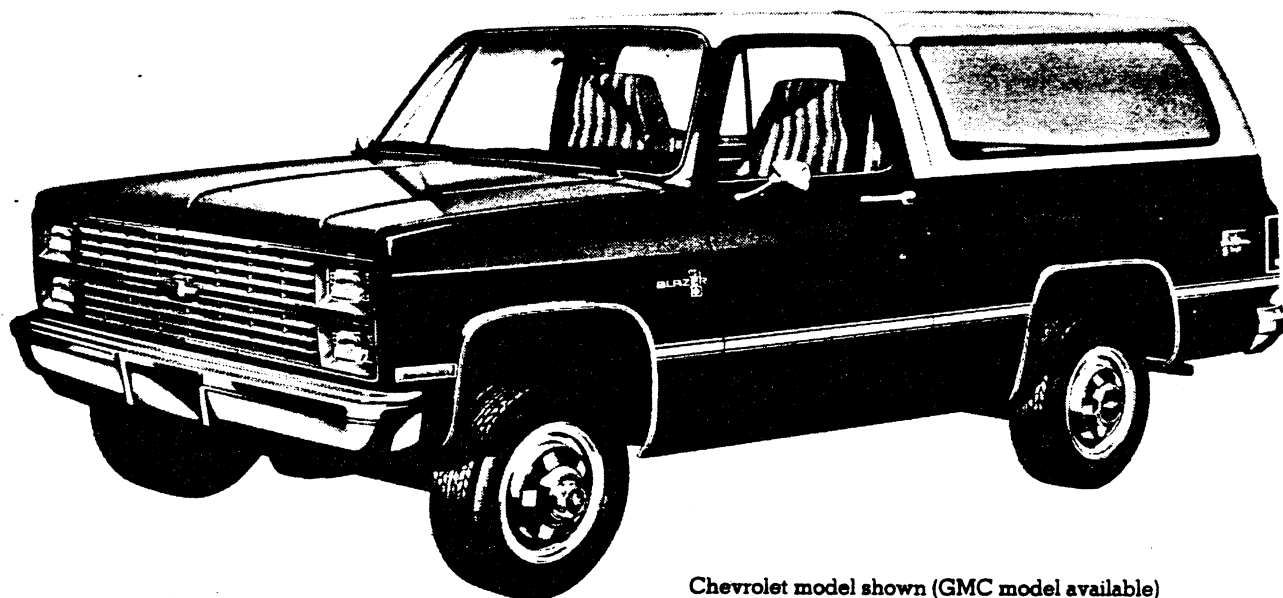

Chevrolet model shown (GMC model available)

K BLAZER/JIMMY

SILVERADO/SIERRA CLASSIC MODEL OPTION—RPO YE9

This option includes all Custom Deluxe/Sierra standard model items plus the additions or substitutions listed below

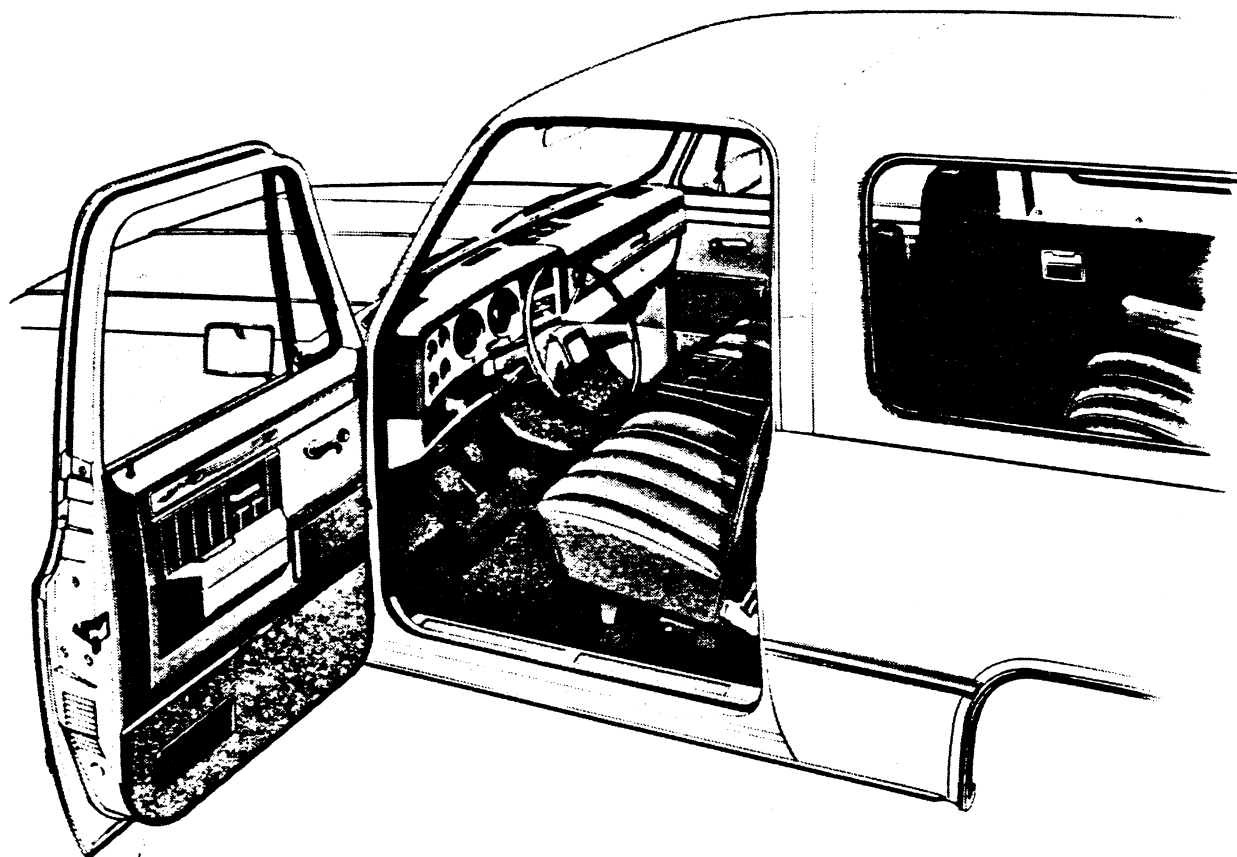

INTERIOR

- **Bright Appearance Items:**
 - "Silverado/Sierra Classic" nameplate on instrument panel pad
 - MM4 four-speed transmission shift lever
 - Trim on instrument cluster bezel, instrument panel pad applique, interior trim panels and on horn button
- **Cigar Lighter:** Includes fiber optic illuminated ashtray
- **Console:** Color-keyed molded plastic with storage/beverage pockets
- **Cowl Panel Trim:** Color-keyed molded plastic on entire surface of cowl side panels
- **Floor Covering:** Color-keyed front compartment carpeting (matching rear compartment floor covering, including wheel-housings, is also provided with optional rear seat)
- **Headliner:** Front compartment; mystic color foam-backed cloth; includes matching windshield pillar and retainer moldings
- **Instrument Cluster:** Voltmeter, oil pressure gage, and engine temperature gage replace warning lamps; includes pewter-toned brush-finished bezel
- **Instrument Panel Pad Applique:** Pewter-toned brushed finish with bright, black and silver trim
- **Insulation:** Extra-thick floor insulators (including rear compartment floor and wheelhousings with optional rear seat)
- **Seats:** Choice of: 1) all-vinyl leather grained trim; or 2) cut pile velour cloth/vinyl trim. See Interior and Exterior Color Selection Chart for color and trim availability
- **Spare Tire Cover:** Black vinyl
- **Special Insulation:** Insulator under cowl top panel
- **Steering Wheel:** Bright trim on horn button
- **Trim Panels:** Molded, color-keyed plastic front door trim panels, door closing assist straps, pewter-toned brush-finished upper decorative inserts having bright, black and silver borders; vinyl storage pockets; vinyl inserts in armrest area plus carpeting and bright trim strips on lower portions. Color-keyed embossed vinyl rear compartment sidewall trim panels with ashtrays and carpet trim
- **Visor Mirror:** On RH sun visor

K BLAZER

OPTIONAL SEATS

The driver and front passenger seats for Custom Deluxe/Sierra (standard) models are available with optional all-vinyl leather grain trim in a choice of blue or saddle tan. This option includes a color-keyed plastic floor console between the seats, color-keyed front carpeting and extra-thick front floor insulation.

When the Silverado/Sierra Classic Model Option (RPO YE9) is ordered, a choice of either leather grain all-vinyl trim or cut-pile velour cloth and vinyl trim in blue, burgundy, saddle tan or slate grey.

A three-passenger folding rear seat with armrests (RPO AM7) is available for all models. Seat belts are provided at all seating positions, with outboard units incorporating retractors. LH and RH ashtrays mounted to the sidewalls also are provided. The seat trim and floor covering match those of the front compartment, and rear wheelhousing insulation and carpeting are included when the leather grain all-vinyl front seats or cut-pile velour cloth and vinyl front seats are ordered.

SEATING ARRANGEMENTS

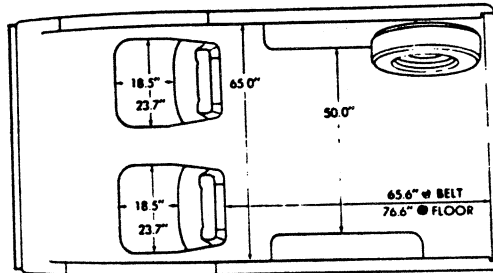

Standard front driver and passenger bucket seats

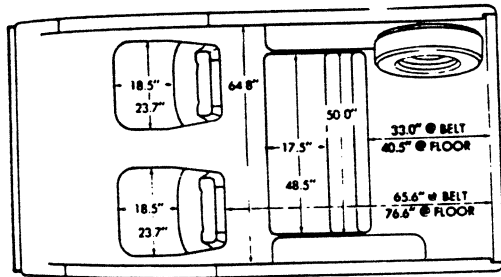

Front and 3-passenger rear seat

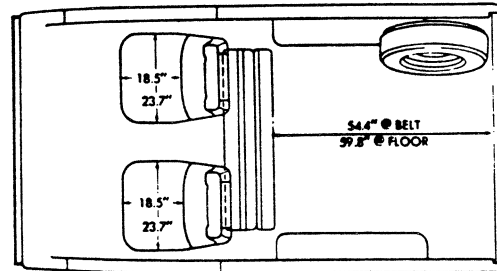

**Front and 3-passenger rear seat
(rear seat shown in folded position)**

DIMENSIONS

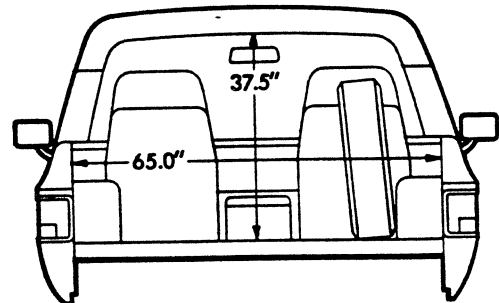
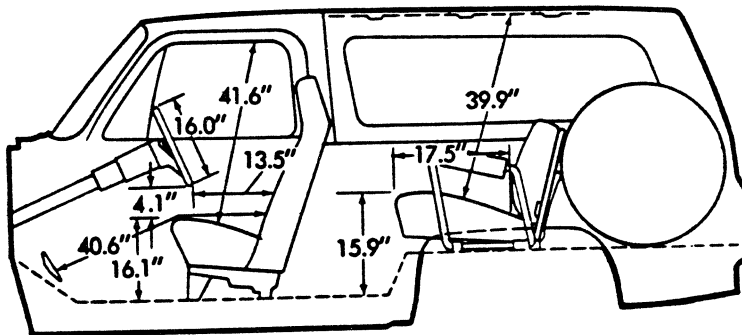

Glass Area (sq. in.)

Windshield..... 1447
**Side door, including venti-
 pane (each side)..... 546**

**Removable top side win-
 dow (each side)..... 894**
**Tailgate drop glass (Hard-
 top models)..... 1077**

K BLAZER/JIMMY

INTERIOR AND EXTERIOR COLOR AVAILABILITY CHART

Please Note: Below are the interior trim color and exterior paint combinations *recommended* by Chevrolet/GMC. The only available primary/secondary exterior color combinations are those shown in the chart below; however, any available interior trim color may be ordered with one of these exterior color combinations if that particular combination is desired by the customer.

INTERIOR COLORS		Decor	Blue	Burgundy	Saddle Tan	Slate Grey		
CUSTOM DELUXE/SIERRA		Std.	VDD4		VSS4			
Vinyl High Back Bucket Seats			XDD4		XSS4			
Custom Vinyl High Back Bucket Seats								
SILVERADO/SIERRA CLASSIC		YE9	XDD4	XEE4	XSS4	XTT4		
Custom Vinyl High Back Bucket Seats			LDD4	LEE4	LSS4	LTT4		
Custom Cloth High Back Bucket Seats								
EXTERIOR COLORS w/ZY1 or ZY3 PAINT	Primary	Secondary	RECOMMENDED INTERIOR TRIM COLOR				Required Body	
BLACK, MIDNIGHT	19	19		X	X	X	Z58, Z59	
Silver (Metallic)	19	17				X	Z59	
Tan, Doeskin	19	61			X		Z59	
White, Frost	19	12				X	Z58, Z59	
BLUE, LIGHT (Metallic)	21	21	X			X	Z58, Z59	
Blue, Midnight	21	29	X				Z58	
Silver (Metallic)	21	17	X			X	Z59	
White, Frost	21	12	X				Z58	
BLUE, MIDNIGHT	29	29	X			X	Z58, Z59	
Blue, Light (Metallic)	29	21	X				Z58	
White, Frost	29	12	X				Z58	
BRONZE, INDIAN (Metallic)	66	66			X		Z58, Z59	
White, Frost	66	12			X		Z58	
RED, APPLE	72	72		X	X		Z58, Z59	
White, Frost	72	12		X			Z58	
SAND, DESERT (Metallic)	64	64			X		Z58, Z59	
Black, Midnight	64	19			X		Z59	
White, Frost	64	12			X		Z58	
SILVER (Metallic)	17	17	X	X		X	Z58, Z59	
Black, Midnight	17	19				X	Z59	
White, Frost	17	12				X	Z58	
TAN, DOESKIN	61	61			X		Z58, Z59	
Black, Midnight	61	19			X		Z59	
White, Frost	61	12			X		Z58	
WHITE, FROST	12	12	X	X	X	X	Z58, Z59	
Black, Midnight	12	19		X		X	Z58, Z59	
Blue, Light (Metallic)	12	21	X				Z58	
Blue, Midnight	12	29	X				Z58	
Red, Apple	12	72		X			Z58	
Silver (Metallic)	12	17				X	Z58	
Tan, Doeskin	12	61			X		Z58	
YELLOW, COLONIAL	53	53			X		Z58, Z59	
Black, Midnight	53	19			X		Z59	
White, Frost	53	12			X		Z58	
w/ZY5 PAINT (Exterior and Interior Combinations Shown are the Only Combinations Available)							STRIPE COLOR	
BLACK, MIDNIGHT/Red, Apple	19	72		X			Z59	Vermillion/Black
BLACK, MIDNIGHT/Silver (Metallic)	19	17				X	Z59	Vermillion/Light Slate
BLACK, MIDNIGHT/Tan, Doeskin	19	61			X		Z59	Vermillion/Black
BLACK, MIDNIGHT/White, Frost	19	12				X	Z58, Z59	Vermillion/Black
WHITE, FROST/Black, Midnight	12	19				X	Z58, Z59	Vermillion/Black
WHITE, FROST/Blue, Light (Metallic)	12	21	X				Z58	Dark Blue/Light Blue
WHITE, FROST/Red, Apple	12	72		X			Z58	Vermillion/Dark Carmine
WHITE, FROST/Tan, Doeskin	12	61			X		Z58	Dark Brown/Almond
YELLOW, COLONIAL/Tan, Doeskin	53	61			X		Z58	Dark Brown/Almond
YELLOW, COLONIAL/White, Frost	53	12			X		Z58	Dark Brown/Almond

K BLAZER/JIMMY

SOLID AND TWO-TONE* EXTERIOR COLOR COMBINATIONS

The application of paint for solid and two-tone exterior color combinations is shown below.

Solid Color (ZY1) paint is standard on all models. All painted areas of the body and front end sheet metal (except the cab roof and removable top) are painted the same color. The cab roof and removable top are painted either black or white.

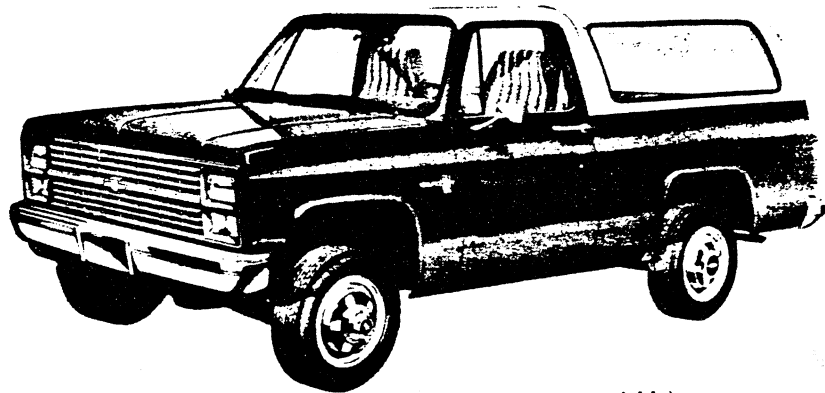

Chevrolet model shown (GMC model available)

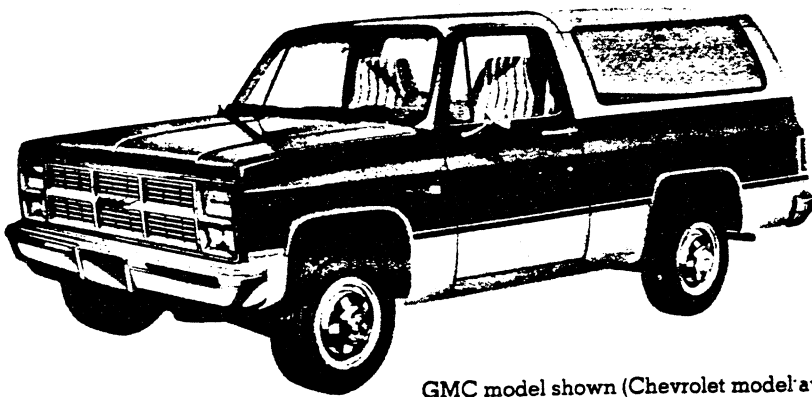

GMC model shown (Chevrolet model available)

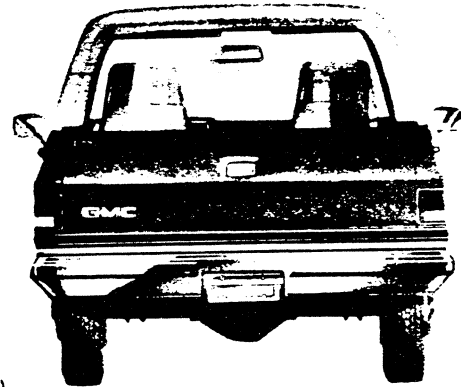

Special two-tone (ZY3) paint colors are available on all models and include the YG1 molding package consisting of black vinyl body side and rear moldings with bright trim, bright wheel opening moldings, and bright trim for front side marker lights and tail lights (except with the YG3 molding package or the Silverado/Sierra Classic Model Option where bright body side and

rear moldings with black paint trim are substituted). The primary color is applied to the areas above the moldings (except roof areas). The secondary color is applied to the areas below the moldings. The cab roof, including the drip rails, and the removable top will be painted black or white as ordered. (See Interior and Exterior Color Availability Chart to determine cab roof and top color availability.)

Exterior Decor Package (ZY5) paint colors and trim are available in a choice of ten combinations (see Interior and Exterior Color Availability Chart). This package includes the moldings described under Special two-tone. In addition, it includes dual-tone body side and rear tape decal striping keyed to the exterior body color. This striping is applied to the front fenders, side doors and body sides and rear, a few inches above the styling crease line. The areas above the striping (except the cab roof and the removable top) and below the moldings are painted the primary color. The secondary color is used between the striping and the moldings. The cab roof, including the drip rails, and the removable top will be painted black or white as ordered. (See Interior and Exterior Color Availability Chart to determine cab roof and top color availability.) A bright spring-loaded, stand-up type hood ornament is also included on gasoline engine models.

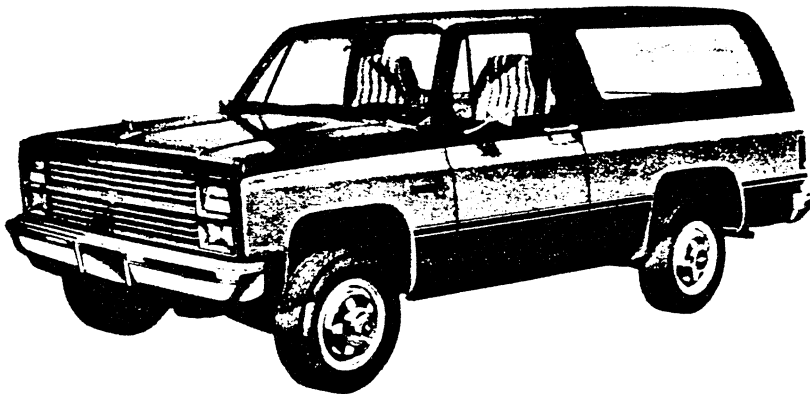

Chevrolet model shown (GMC model available)

*Optional at extra cost.