

ASTRO/SAFARI SL
 (Passenger Van)
ASTRO/SAFARI SL PASSENGER VAN MODEL SELECTOR

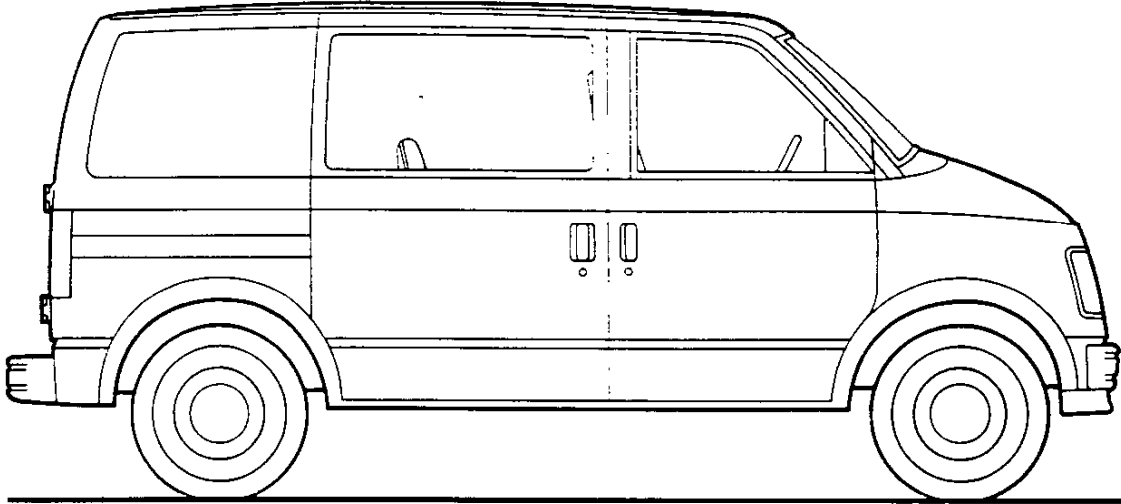

SERIES	MODEL NUMBER	BODY ORDERING CODE		
		ASTRO/SAFARI SL	ASTRO CS/SAFARI SLX	ASTRO CL/SAFARI SLE
M10	M10906	ZW9	YC5	YC6

ASTRO/SAFARI SL

(Passenger Van)

STANDARD SPECIFICATIONS

(See Gray Tab Section for Specification Details)

Series	710
Engine Base Equip. Clutch Air Filter Oil Filter Exhaust System Emission Control Systems	4.3 Liter (262 Cu. In.), EFI V6 11"; 124 sq. in. Oiled-paper Element Throwaway Type Single Aluminized See Engine & Cooling Section for specific model applications
Suspension, Front Type Axle Capacity Axle Ratio Springs @ Ground Shock Absorbers Stabilizer Bar	Independent Coil Springs 2700 lb. — 1350 lb. ea. 25mm dia. 1.26" dia.
Suspension, Rear Type Axle Capacity Axle Ratio Springs, Main @ Ground Shock Absorbers	Salisbury Axle; Hypoid Drive; Variable Rate Leaf Springs Composite Single Leaf Springs 2900 lb. 3.73 1450 lb. ea. 25mm dia.
Brakes Front Rear Booster Parking	Hydraulic; Self-adjusting Disc; 12" Rotor Drum; 9.49" x 2" Single Diaphragm Cable to Rear Wheels
Electrical Battery — Freedom Type — Reserve Capacity Delcotron Generator	12 Volt; Negative Ground 500 CCA ♦ @ 0°F. 90 min. @ 80°F. 85 amp.
Frame	Integral Body-frame with Box Section Front Stub Frame
Fuel Tank (nominal capacity)	17 gal.
Steering Gear Type Linkage	Manual; Recirculating Ball Gear Parallelogram
Transmission Shift Location	5-Speed Manual Floor
Tires Spare	(4) P195/75R15 (All Seasons Steel Belted Radial) (1) T145/80D16
Wheels Spare	(4) Disc, 15" x 6" (1) Disc, 16" x 4"

♦ CCA-Cold Cranking Amps

ASTRO/SAFARI SL

(Passenger Van)

Body Ordering Codes:

Astro/Safari SL—ZW9

Astro CS/Safari SLX—YC5

Astro CL/Safari SLE—YC6

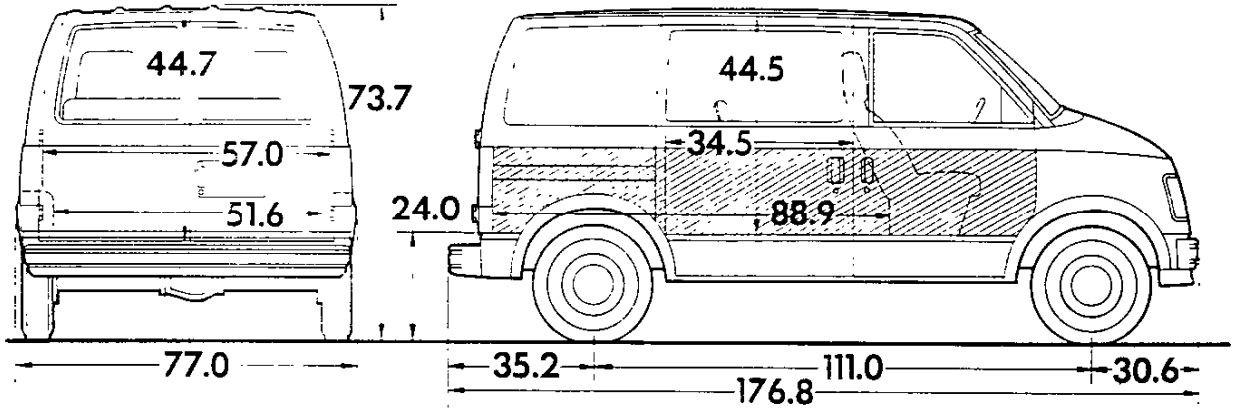

Sign Panel Area (side)
18" x 107"



Capacity (Cu. Ft.)

w/Std. Seating—86.2

w/7- or 8-Pass.—22.7

w/Center Seat Removed—151.5

Model	Body Ordering Code	Engine No. Cyl.	Curb Weight (lb)			Model Weights (lb)*			Ground Clearance (in)*
			Front	Rear	Total	Front	Rear	Total	Minimum
M10906	ZW9	6	1973	1461	3434	2305	1879	4184	7.8
M10906	YC5	6	1998	1511	3509	2330	1929	4259	7.8
M10906	YC6	6	2028	1541	3569	2360	1959	4319	7.8

* Dimensions with standard equipment, unloaded.

*Model Weights include curb weight plus occupants (standard seating capacity x 150 lbs.). Total Weight may vary as much as ±50 lbs. to allow for production build variation.

SEATING CAPACITY SELECTOR

±Maximum Ratings				Minimum Equipment Required for GVW Rating		
Seating Capacity	GVW Range (lb)	±GAWR (lb)		Tires, Front	Tires, Rear	Chassis Equipment
		Front	Rear			

M10906 MODELS

•4, •5	4374 to 5028	2685	2685	P195/75R15	P195/75R15	Standard
	4718 to 5329	2700	2900	P205/75R15	P205/75R15	Increased Cargo Capacity (X6X)
•7	4806 to 5413	2700	2900	P205/75R15	P205/75R15	Standard
•8	4850 to 5384	2700	2900	P205/75R15	P205/75R15	Standard

±GAWRs shown are the maximum for each axle with the equipment listed. Maximum ratings include an additional 50 lbs. allowance for vehicle weight variance.

±GAWR—Gross Axle Weight Rating.

•Requires ZP4, Four-Passenger or ZP5, Five-Passenger Seating.

•Requires ZP7, Seven-Passenger Seating.

♦Requires ZP8, Eight-Passenger Seating.

ASTRO/SAFARI SL

(Passenger Van)

POWER TEAMS

ALL STATES

POWER TEAMS (MUST ORDER ENGINE, TRANSMISSION AND REAR AXLE)
 (Consult GVWR Selector and Tire Chart to insure tire capacity and availability)

ENGINE	TRANSMISSION			AXLES					
	4-SP	5-SP	AUTO	2.73	3.08	3.42	3.73	4.10	
W/NA5 STANDARD EMISSION EQUIPMENT									
LB4 V6 4.3 Liter EFI		MM5		GQ1	GU4				
			MX0	—	GQ1	GU6	*GT4	—	
W/NA6 HIGH ALTITUDE EMISSION EQUIPMENT									
LB4 V6 4.3 Liter EFI		MM5		—	GQ1	GU6			
			MX0	—	GQ1	GU6	*GT4	—	
W/YF5 CALIFORNIA EMISSION EQUIPMENT									
LB4 V6 4.3 Liter EFI		MM5		GQ1	GU4	—	—	—	
			MX0	—	GQ1	GU6	*GT4	—	

*Reqs Z82 Trailering

ENGINE RATINGS—ALL STATES

SAE Net Ratings	4.3 Liter 262 EFI V6
Net Horsepower	145 @ 4000 rpm
Net Torque, lb-ft	230 @ 2400 rpm

ASTRO (PASSENGER VAN)

1986 VEHICLES WITH STANDARD EQUIPMENT

Prices shown are effective with initial shipments of 1986 model motor vehicles

Description	Model Number	Body Code	Wheel Base	Factory D&H(a)	List Price	Mfr's Suggested Retail Price*	Group Number
◆ 6-Cylinder 4.3 Liter (262 Cu. In.) E.F.I. V6 Gasoline Engine-Engine Ordering Code LB4							
M10 Series							
Astro	CM10906	ZW9	111"	N.A.	9037.00	9037.00	13
Astro CS	CM10906	YC5	111"	N.A.	9492.00	9492.00	13
Astro CL	CM10906	YC6	111"	N.A.	10216.00	10216.00	13

★ Manufacturer's Suggested Retail Prices do not include applicable destination charges, state and local taxes, license fees, optional equipment or special items or services.

◆ Refer to Dealer Order Guide for California Requirements.

OPTIONS WHEN INSTALLED BY GENERAL MOTORS

Prices shown are effective with initial shipments of 1986 model motor vehicles

Description	Option Number	Factory D&H(a)	List Price	Mfr's Suggested Retail Price◇
Seat Trim: (See Interior and Exterior Color Selection Chart for ordering information).				
V**4 Standard Vinyl High Back Bucket Not available when YC6 is specified				NO ADDITIONAL CHARGE
X**4 Custom Vinyl High Back Bucket Standard on YC6				
With ZP4 or ZP7 Seating Arrangement				NO ADDITIONAL CHARGE
With ZP8 Seating Arrangement		N.A.	150.00	150.00
With ZP5 Seating Arrangement		N.A.	100.00	100.00
K**4 Custom Cloth High Back Bucket				
With YC6				NO ADDITIONAL CHARGE
With ZP4 or ZP7 Seating Arrangement				NO ADDITIONAL CHARGE
With ZP8 Seating Arrangement		N.A.	150.00	150.00
With ZP5 Seating Arrangement		N.A.	100.00	100.00
Paints, Exterior: (See Interior and Exterior Color Selection Chart for Ordering Information and Paint Application).				
Solid	ZY1			NO ADDITIONAL CHARGE
Special Two-Tone. Includes D85 Striping	ZY3	N.A.	237.00	237.00
Sport Two-Tone	ZY7	N.A.	162.00	162.00
Emission Systems: Dealer Note - One of the following emission options must be specified. (See Power Teams Chart for availability and complete specifications)				
California Emission Requirements. Includes all testing, equipment and/or certification necessary for registration in the State of California. Not available when NA6 High Altitude or NA5 Standard Emissions is specified.				
High Altitude Emission Equipment. Not available when YF5 California Emissions is specified	YF5	N.A.	99.00	99.00
Standard Emission Equipment. Not available when YF5 California or NA6 High Altitude Emissions are specified ..	NA6			NO ADDITIONAL CHARGE
	NA5			NO ADDITIONAL CHARGE
Engines: (See Power Teams Chart for availability and complete specifications)				
Gasoline.				
4.3 Liter (262 Cu. In.) E.F.I. V6	LB4			NO ADDITIONAL CHARGE
Transmissions:				
4-Speed Automatic with Overdrive	MX0	N.A.	520.00	520.00
5-Speed Manual with Overdrive Standard	MM5			NO ADDITIONAL CHARGE
Axles, Rear: (See Power Teams Chart for option number selection, availability and complete specifications)				
Optional Ratio		N.A.	36.00	36.00
Locking Differential. Includes T155/90D16 Compact Spare Tire	G80	N.A.	238.00	238.00
Tires:				
All rim sizes are 6.00 except when ZJ7 Rally Wheels are specified.				
TUBELESS. Includes Compact Spare Tire				

(a) D & H Charges on vehicle and optional equipment include reimbursement to ordering Division for any tax that it has paid, incurred or agreed to pay thereon.

◇ State and local taxes not included.

ASTRO/SAFARI SL (PASSENGER VAN)

OPTIONS WHEN INSTALLED BY GENERAL MOTORS

Prices shown are effective with initial shipments of 1986 model motor vehicles

Description	Option Number	Factory D&H(a)	List Price	Mfr's Suggested Retail Price ◊
(Tires: Continued)				
P195/75R15 All Seasons Steel Belted Radial Ply Blackwall. (Standard)	QAR	NO ADDITIONAL CHARGE		
P195/75R15 All Seasons Steel Belted Radial Ply Whitewall	QAS	N.C.	64.00	64.00
P195/75R15 Highway Fiberglass Belted Radial Ply Blackwall	QYP	NO ADDITIONAL CHARGE		
P205/75R15 All Seasons Steel Belted Radial Ply Blackwall	QCE	N.C.	31.00	31.00
P205/75R15 All Seasons Steel Belted Radial Ply Whitewall	QCG	N.C.	99.00	99.00
P205/75R15 All Seasons Steel Belted Radial Ply White Lettered	QCF	N.C.	122.00	122.00

OTHER OPTIONS

Air Conditioning: All Weather. Includes V01 H.D. Radiator when V02 H.D. Radiator and Transmission Oil Cooler is not specified.

Front. Instrument panel mounted. Recommended for front seat area cooling only.

Without YC5 or YC6

With YC5 or YC6

Front and Rear. Front instrument panel mounted and rear overhead systems. Available only when YC5 or YC6 is specified. Includes K60 100-Amp Generator

Battery: Heavy-Duty. 12-Volt, 515 Cold Cranking Amps Delco Freedom. Included with V10 Cold Climate Package is specified

Bumper Equipment:

Bumpers, Deluxe Front and Rear. Chromed with color-keyed end caps and black rub strips.

Without YC6

With YC6

Bumpers, Color-Keyed with color-keyed end caps and black rub strips. Standard on YC6

Cargo Capacity, Increased: Available only when ZP4 or ZP5 Seating Arrangement and P205 Tires are specified. Includes F59 Stabilizer Bar and N40 Power Steering

Carrier, Spare Tire: Includes hoist. Standard on YC5 and YC6

Cooling Systems:

Engine Oil. Included with Z82 Trailering Special. Available only when V01 H.D. Radiator or V02 H.D. Radiator and Transmission Oil Cooler is specified

Radiator, Heavy-Duty: Included when C60 Front or C69 Front and Rear Air Conditioning is specified without V02 H.D. Radiator and Transmission Cooler

Radiator and Transmission Oil, Heavy-Duty. Included with Z82 Trailering Special. Available only when MX0 Automatic Transmission is specified. Not available when V01 H.D. Radiator is specified

Without C60 Front or C69 Front and Rear Air Conditioning

With C60 Front or C69 Front and Rear Air Conditioning

Cold Climate Package: Includes K05 Engine Block Heater, UA1 H.D. Battery and anti-freeze protection to -32 degrees.

Without YC5 or YC6

Without C60 Front Air Conditioning. Also includes K60 100-Amp Generator and C42 Deluxe Heater and Defogger

With C60 Air Conditioning. Also includes K60 100-Amp Generator

With YC5 or YC6

Without C69 Front and Rear Air Conditioning. Includes K60 100-Amp Generator

With C69 Front and Rear Air Conditioning

(a) D & H Charges on vehicle and optional equipment include reimbursement to ordering Division for any tax that it has paid, incurred or agreed to pay thereon.
 ◊ State and local taxes not included.

ASTRO/SAFARI SL (PASSENGER VAN)

OPTIONS WHEN INSTALLED BY GENERAL MOTORS

Prices shown are effective with initial shipments of 1986 model motor vehicles

Description	Option Number	Factory D&H(a)	List Price	Mfr's Suggested Retail Price [◇]
OTHER OPTIONS				
Console, Roof: Available only when TR9 Auxiliary Lighting or YC6 is specified. Includes dome lamp, map lamps and two stowage compartments	DK6	N.A.	79.00	79.00
Door Lock System, Power: All Doors. Included when ZQ2 Operating Convenience Package is specified	AU3	N.A.	198.00	198.00
Filler Door, Fuel: Inside Remote Release. Standard on YC5 or YC6	N08	N.A.	25.00	25.00
Floor Covering:				
<i>Carpeting, Wheelhousing and Floor.</i> Standard on YC6. Available only when YC5 is specified	B30	N.A.	111.00	111.00
<i>Rubber, Wheelhousing and Floor, Color-Keyed.</i> Standard on YC5. Not available on YC6	BG9	N.A.	43.00	43.00
<i>Mats, Color-Keyed, Removable.</i> Available only when YC5 or YC6 and B30 Carpeting is specified.				
With ZP4 4 Passenger Bucket Seating Arrangement or ZP5 5 Passenger Seating Arrangement	B37	N.A.	45.00	45.00
With ZP7 7 Passenger or ZP8 8 Passenger Seating Arrangement	B37	N.A.	65.00	65.00
Gages: Voltmeter, Temperature, Oil Pressure and Trip Odometer. Standard on YC6	Z53	N.A.	58.00	58.00
Generator: 100-Amp Delcotron. Included when V10 Cold Climate Package or C69 Front and Rear Air Conditioning is specified	K60	N.A.	30.00	30.00
Glass Arrangements: Complete Body. Available only when P18 Spare Wheel Carrier, YC5 or YC6 is specified ..	ZW6	N.A.	121.00	121.00
Glass, Tinted:				
All Windows. Includes A02 Windshield Glass.				
Without ZW6 Complete Body Glass	A01	N.A.	71.00	71.00
With ZW6 Complete Body Glass	A01	N.A.	98.00	98.00
Windshield only. Included when A01 Tinted, AA3 Deep Tinted or AJ1 Deep Tinted Glass is specified	A02	N.A.	38.00	38.00
<i>Deep Tinted.</i> Not available when A01 Tinted Glass is specified. Includes tinted glass on passenger and driver's side door. Also includes A02 Windshield Glass and dark coated glass on side windows and rear door.				
Without ZW6 Complete Body Glass	AJ1	N.A.	225.00	225.00
With ZW6 Complete Body Glass	AJ1	N.A.	345.00	345.00
<i>Deep Tinted with Light Tinted Rear Window.</i> Not available when A01 Tinted or AJ1 Deep Tinted Glass is specified. Includes tinted glass on passenger, driver's side and rear doors. Also includes A02 Tinted Windshield and dark coated glass on side windows.				
Without ZW6 Complete Body Glass	AA3	N.A.	173.00	173.00
With ZW6 Complete Body Glass	AA3	N.A.	293.00	293.00
Glass, Swing-Out: Rear door	A18	N.A.	55.00	55.00
Grille, Deluxe: Black with Argent Trim. Standard on YC6	TL1	N.A.	25.00	25.00
Harness, Wiring: Trailer, 5-lead. Not available when Z82 Trailing Special is specified. Included with Z72 Trailing Special	U89	N.A.	39.00	39.00
Headlamps: Halogen.	TT4	N.A.	22.00	22.00
Heaters:				
<i>Engine Block, 600 Watts, 120 Volts.</i> Included when V10 Cold Climate Package is specified	K05	N.A.	31.00	31.00
<i>Rear.</i> Located on left side, forward of rear fender well	C36	N.A.	256.00	256.00
<i>Deluxe, Heater and Defogger.</i> Included with V10 Cold-Climate Package, YC5 or YC6. Not available when C60 Front or C69 Front and Rear Air Conditioning is specified	C42	N.A.	43.00	43.00
Lamp: Dome and Reading. Available only when TR9 Auxiliary Lighting or YC6 is specified. Not available when DK6 Roof Console is specified	C95	N.A.	31.00	31.00

(a) D & H Charges on vehicle and optional equipment include reimbursement to ordering Division for any tax that it has paid, incurred or agreed to pay thereon.
[◇] State and local taxes not included.

ASTRO/SAFARI SL (PASSENGER VAN)

OPTIONS WHEN INSTALLED BY GENERAL MOTORS

Prices shown are effective with initial shipments of 1986 model motor vehicles

Description	Option Number	Factory D&H(a)	List Price	Mfr's Suggested Retail Price ◇
OTHER OPTIONS				
Lighter, Cigarette: Includes ash tray light. Included with TR9 Auxiliary Lighting. Standard on YC6	U37	N.A.	30.00	30.00
Lighting, Auxiliary: Included with YC6. Includes U37 Cigarette Lighter, glove box and convenience tray lamps, door jamb switches on all doors, stepwell lamps for front and sliding doors and door jamb defeat switch				
Without YC5. Also includes headlamp warning chimes	TR9	N.A.	142.00	142.00
With YC5	TR9	N.A.	121.00	121.00
Mirrors:				
<i>Deluxe</i> LH and RH. Below Eye-Line. Painted Black	D44	N.A.	50.00	50.00
<i>Visor, Vanity, Illuminated, RH.</i> Available only when Custom Cloth or Custom Vinyl Trim is specified				
Without YC5 or YC6	D64	N.A.	48.00	48.00
With YC5 or YC6	D64	N.A.	41.00	41.00
Moldings:				
<i>Body Side, Black.</i> Standard on YC6	B84	N.A.	55.00	55.00
<i>Wheel Opening, Black.</i> Standard on YC6	B96	N.A.	29.00	29.00
<i>Guards, Door Edge, Black</i>	B93	N.A.	17.00	17.00
Operating Convenience Package: Includes AU3 Power Door Locks and A31 Power Windows	Z02	N.A.	388.00	388.00
Panels, Interior: Protective closeout for Lower Quarter. Not available when YC5, YC6, ZP7 or ZP8 Seating Arrangements is specified	E48	N.A.	25.00	25.00
Preliminary Price Information	B3W	N.A.	N.A.	N.A.
Radio Equipment:				
<i>AM Radio.</i> Includes dual front speakers	U63	N.A.	112.00	112.00
<i>AM/FM Radio.</i> Includes dual front speakers	U69	N.A.	171.00	171.00
<i>AM/FM Stereo Radio.</i> Electronically Tuned. Includes dual front speakers.				
Without YC5 or YC6. Also includes wiring for rear speakers	UU9	N.A.	243.00	243.00
With YC5 or YC6. Also includes four rear speakers	UU9	N.A.	283.00	283.00
<i>AM/FM Stereo Radio with Seek and Scan and Digital Clock.</i> Electronically Tuned. Includes dual front speakers.				
Without YC5 or YC6. Also includes wiring for rear speakers	UM7	N.A.	302.00	302.00
With YC5 or YC6. Also includes four rear speakers	UM7	N.A.	342.00	342.00
<i>AM/FM Stereo Radio with Seek and Scan, Stereo Cassette Tape and Digital Clock.</i> Electronically Tuned.				
Without YC5 or YC6. Also includes wiring for rear speakers	UM6	N.A.	424.00	424.00
With YC5 or YC6. Also includes four rear speakers	UM6	N.A.	464.00	464.00
<i>AM Stereo and FM Stereo Radio with Seek and Scan, Stereo Cassette Tape with Search and Repeat, Graphic Equalizer and Digital Clock.</i> Electronically Tuned.				
Without YC5 or YC6. Also includes wiring for rear speakers	UX1	N.A.	574.00	574.00
With YC5 or YC6. Also includes four rear speakers	UX1	N.A.	614.00	614.00
Seating Arrangements: One of the following seat options must be specified.				
<i>Four Passenger Seating.</i> Includes Four High Back Bucket Seats. 2-Front and 2-Midship. Includes seat adjuster, seat belts and A78 Seat Back Recliner and Dual Armrests on all seats. Deletes standard center seat. Not available when standard vinyl trim is specified.				
Without YC6	ZP4	N.A.	634.00	634.00
With YC6	ZP4	N.A.	552.00	552.00

(a) D & H Charges on vehicle and optional equipment include reimbursement to ordering Division for any tax that it has paid, incurred or agreed to pay thereon.
 ◇ State and local taxes not included.

ASTRO/SAFARI SL (PASSENGER VAN)

OPTIONS WHEN INSTALLED BY GENERAL MOTORS

Prices shown are effective with initial shipments of 1986 model motor vehicles

Description	Option Number	Factory D&H(a)	List Price	Mfr's Suggested Retail Price [◇]
OTHER OPTIONS				
(Seating: Continued)				
<i>Five Passenger Seating</i> Standard. Includes two High-Back front bucket seats, seat belts, and fold-down feature on bench seat and R.H. Armrest	ZP5			NO ADDITIONAL CHARGE
<i>Seven Passenger Seating.</i> Includes ZP4 Four High-Back Bucket Seats, A78 Seat Back Recliner and Dual Armrests, three passenger rear bench seat, N40 Power Steering and F59 Front Stabilizer. Also includes seat belts and armrests mounted on rear wheel housings. Available only when P205 Tires are specified. P18 Spare Wheel Carrier must be specified without YC5 or YC6				
Without YC6	ZP7	N.A.	1277.00	1277.00
With YC6	ZP7	N.A.	1195.00	1195.00
<i>Eight Passenger Seating.</i> Includes ZP5 5-passenger seating, three passenger rear seat, N40 Steering and F59 Front Stabilizer. Also includes seat belts, R.H. armrest and fold-down feature on center seat. Rear seat includes seat belts and armrests mounted on rear wheel housings and fold-down feature. Available only when P205 Tires are specified. P18 Spare Wheel Carrier must be specified without YC5 or YC6				
Without YC6	ZP8	N.A.	593.00	593.00
With YC6	ZP8	N.A.	643.00	643.00
Seat Back Recliner and Dual Armrests: For high back driver and front passenger seats only. Available only when Custom Trim is specified. Included when ZP4 or ZP7 Seating Arrangement is specified.	A78	N.A.	230.00	230.00
Shock Absorbers: Heavy Duty. Front and Rear	F51	N.A.	34.00	34.00
Speed Control, Electronic	K34	N.A.	195.00	195.00
Stabilizer Bar: Front. Included with X6X Increased Cargo Capacity, ZP7 or ZP8 Seating Arrangement	F59	N.A.	38.00	38.00
Steering:				
<i>Power.</i> Available only when F59 Front Stabilizer Bar is specified. Included with X6X Increased Cargo Capacity, ZP7 or ZP8 Seating Arrangement.	N40	N.A.	276.00	276.00
<i>Power, Not Desired</i>	N51			NO ADDITIONAL CHARGE
Steering Wheels:				
<i>Comfortilt</i>	N33	N.A.	115.00	115.00
<i>Custom.</i> Standard on YC6	N31	N.A.	26.00	26.00
Stop, Positive: Rear Door. Standard on YC5 or YC6	AD8	N.A.	35.00	35.00
Storage Compartment: Front Seats Only. Includes compartment door				
<i>R.H. and L.H. only.</i> Includes BA9 Storage Compartment	BA8	N.A.	70.00	70.00
<i>L.H. only.</i> Included with BA8 R.H. and L.H. Storage Compartments	BA9	N.A.	35.00	35.00
Striping, Body: With ZY1 Solid Paint available only when the following stripe color is specified. Included with ZY3 Special Two-Tone Paint	D85	N.A.	75.00	75.00
Stripe Color: Available only when ZY1 Solid Paint and D85 Striping are specified. (Refer Color and Trim Chart for option availability)				
<i>Blue with Silver Border</i>	25A			NO ADDITIONAL CHARGE
<i>Gold with Brown Border</i>	54A			NO ADDITIONAL CHARGE
<i>Red with Black Border</i>	74A			NO ADDITIONAL CHARGE
<i>Red with Silver Border</i>	71A			NO ADDITIONAL CHARGE
<i>Yellow-Orange with White Border</i>	53A			NO ADDITIONAL CHARGE
Tank, Fuel: Approximately 27-gallon capacity. Replaces production fuel tank	NL9	N.A.	66.00	66.00
Tie-Downs, Cargo: Available only when ZP4 or ZP5 Seating Arrangement and X6X Increased Cargo Capacity are specified	AP1	N.A.	30.00	30.00

(a) D & H Charges on vehicle and optional equipment include reimbursement to ordering Division for any tax that it has paid, incurred or agreed to pay thereon.
[◇] State and local taxes not included.

ASTRO/SAFARI SL (PASSENGER VAN)

OPTIONS WHEN INSTALLED BY GENERAL MOTORS

Prices shown are effective with initial shipments of 1986 model motor vehicles

Description	Option Number	Factory D&H(a)	List Price	Mfr's Suggested Retail Price◇
OTHER OPTIONS				
Trailer Hitch: Deadweight Type. Not available when Z82 Trailing Special is specified. Included with Z72 Trailing Special	VR2	N.A.	64.00	64.00
Trailing Special Equipment: (See Trailing Guide for GCW Ratings with available power team combinations.)				
Heavy-Duty. Includes Weight Distributing Hitch Platform, H.D. flashers, H.D. 7 Lead Wiring Harness, KC4 Engine Oil Cooler and VO2 H.D. Radiator and Transmission Oil Cooler. Available only when N40 Power Steering, UA1 H.D. Battery, F51 H.D. Shock Absorbers, F59 Stabilizer and MX0 Automatic Transmission are specified. Also available only when 3.42 or 3.73 Rear Axle Ratio is specified				
Without C60 Front or C69 Front and Rear Air Conditioning	Z82	N.A.	524.00	524.00
With C60 Front or C69 Front and Rear Air Conditioning	Z82	N.A.	471.00	471.00
Light-Duty. Includes VR2 Deadweight Trailer Hitch, H.D. flashers and U89 5 Lead Wiring Harness. Available only when MX0 Transmission and VO1 H.D. Radiator or VO2 H.D. Radiator and Transmission Oil Cooler and 3.08 Rear Axle Ratio or 3.42 Rear Axle Ratio is specified.	Z72	N.A.	103.00	103.00
Wheel Trim:				
Wheel Covers: Bright Metal. Includes black wheel Standard on YC6	P01	N.A.	40.00	40.00
Trim Rings. Includes black wheel. Included with ZJ7 Rally Wheels. Not available when YC6 is specified	P06	N.A.	56.00	56.00
Wheels:				
Rally, 6.5". Argent. Includes special hub caps and P06 Trim Rings				
Without YC6	ZJ7	N.A.	88.00	88.00
With YC6	ZJ7	N.A.	48.00	48.00
Aluminum, Cast: Four wheels only. Includes 15" x 6.5" wheels and special hub caps.				
Without YC6	PF3	N.A.	299.00	299.00
With YC6	PF3	N.A.	259.00	259.00
Windows: Power. Front side doors only. Included when ZQ2 Operating Convenience Package is specified	A31	N.A.	190.00	190.00
Windshield Wiper System: Intermittent	CD4	N.A.	55.00	55.00

(a) D & H Charges on vehicle and optional equipment include reimbursement to ordering Division for any tax that it has paid, incurred or agreed to pay thereon.
 ◇ State and local taxes not included.

ASTRO/SAFARI SL

CAB & BODY FEATURES SEATING ARRANGEMENTS COLOR & TRIM CHARTS TWO-TONES

ASTRO/SAFARI SL

(Passenger Van)

STANDARD MODEL—BODY ORDERING CODE—ZW9

The standard model includes the following items as standard equipment

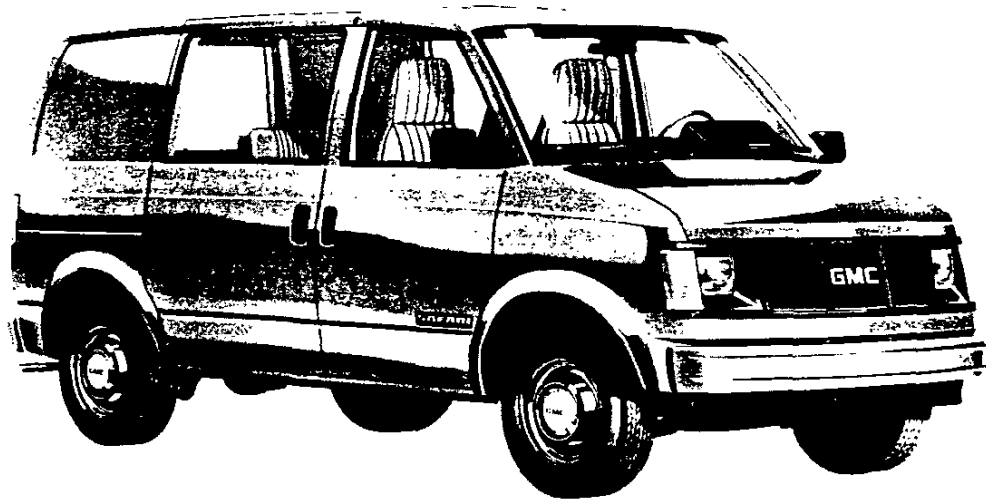
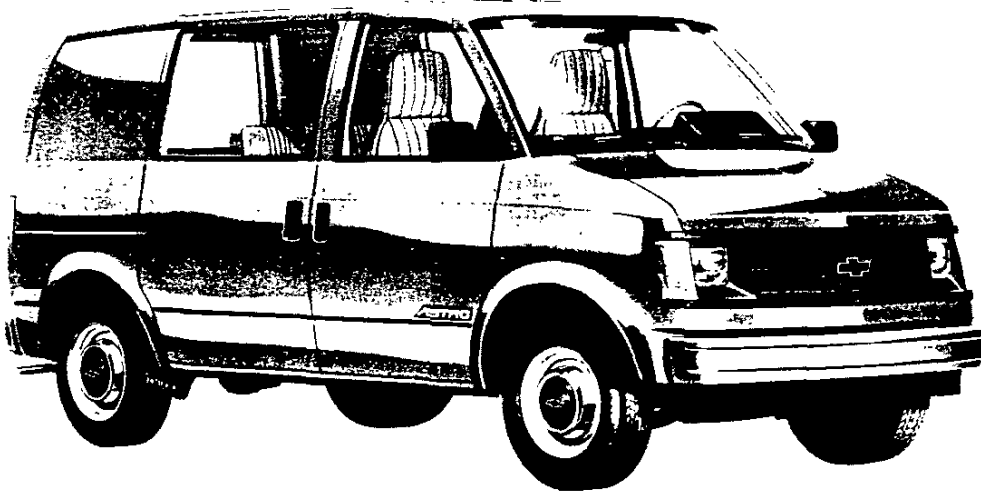

EXTERIOR

- **Bumpers:** Front and rear; painted lower body color
- **Colors:** See Interior and Exterior Color Selection Chart
- **Doors:** RH and LH front side doors; RH and LH rear load doors; and a RH sliding side load door
- **Door Opening and Locking Methods:**
 - Front side doors: Outside flush pull-out type door handle with separate key lock
 - Sliding side load door: Outside flush pull-out type handle releases both front and rear latches; for opening and closing of door from inside, reverse outside procedure
 - RH and LH rear doors: Flush pull-out type RH door handle opens door, and after opening RH door, LH door latch is released by inside handle; key lock cylinder in RH door
- **Glass:** Windshield; RH and LH front side door drop glass; side swing-out sliding door glass; RH and LH rear door glass; and LH front swing-out quarter glass
- **Grille:** Molded plastic; painted black; integral Chevrolet emblem/GMC letters at center
- **Headlamps/Parking Lamps:** Headlamp/parking lamp bezels painted black
- **Horn:** Single, electric low-note
- **Hub Caps:** Bright metal with black trim
- **Keys:** Two-key system with separate keys for ignition switch and doors
- **Lights:**
 - Backup lamps: Two rear (integral with taillamps)
 - Combination parking/direction/hazard: Two front
 - Combination tail/stop/direction/hazard: Two rear
 - Headlamps: Two; Rectangular
 - License plate lamp: Single rear
 - Side marker lamps with reflectors: Integral with front parking lamps and rear taillamps
- **Mirrors:** RH and LH painted black; pivoting arm with adjustable 34.1 sq. in. head
- **Nameplates:** Bright "Astro/Safari" plate on front doors; "Chevrolet/GMC" letters plate on RH rear door in license plate housing
- **Tools:** Screw operated scissor-type jack with ratchet handle, extension and two wheel blocks
- **Undercoating:** Hot melt wax on entire underbody
- **Wheels:** Painted argent
- **Windshield Wipers and Washers:** Electric, 2-speed wipers with black finish on exposed metal portions; wet-arm design demand-type washer system

ASTRO/SAFARI SL

(Passenger Van)

STANDARD MODEL—BODY ORDERING CODE—ZW9

The standard model includes the following items as standard equipment



INTERIOR

- **Air Vents:** Integral with heater
- **Armrests:** LH and RH
- **Ashtray:** At center in engine cover console
- **Coat Hooks:** On LH roof rail to rear of driver's seat
- **Colors:**
Painted areas: Same as exterior primary color choice
Interior trim: Coordinated with seat trim color choice
- **Dome Lamps:** Two; with front door-actuated switches (dome lamps may also be activated by main light switch)
- **Door Locks:** Inside lock/release for front doors and sliding side door
- **Door Seals:** Latex foam rubber
- **Floor Covering:** Embossed black rubber mats on entire floor area
- **Headliner:** Color-keyed molded styrofoam with foam and cloth cover; driver area
- **Heater and Defogger:** Deluxe-air
- **Hood Lock Release:** Handle located on RH side of instrument panel
- **Instruments:**
Gages: Speedometer, odometer, and fuel
Switches: Main, for control of exterior lights, instrument lights and dome lights; multi-function switch on steering column for direction signals by moving lever up or down (includes lane change position), headlight beams by pulling lever toward driver, windshield wiper by turning band marked "WIPE" toward or away from driver, and windshield washer by pushing in the lever knob; ignition with key-in warning buzzer; hazard warning; heater fan; door-operated dome lamp

Warning lights: Generator, oil pressure, engine temperature, service-parking brake, direction/hazard signal, and high beam

- **Instrument Panel:** Molded black plastic faceplate
- **Insulation and Sound Deadening Material:** Dash (firewall), front floor panel, engine cover front extension and inside engine cover
- **Lights:** Instruments, front and rear dome
- **Seat:** Front high back bucket driver and front passenger; adjustable; all-vinyl trim; foam padded plus center 3-passenger bench seat. Also available at extra cost: High back center bucket seats and rear 3-passenger bench seat in standard vinyl, Custom vinyl or Custom Cloth. See Interior and Exterior Color Selection Chart for color and trim availability
- **Seat Belts:** Color-keyed with pushbutton release for all seating positions
- **Spare Tire Carrier:** LH rear side
- **Steering Wheel and Column:** 15.24" diameter black vinyl wheel; black energy-absorbing steering column with anti-theft locking feature
- **Stowage Box:** In front face of engine cover extension; with latched door; includes beverage holder provisions
- **Sunshade:** LH and RH, color-keyed
- **Trim Panels:** Injection molded plastic panels on front and sliding side doors; with storage pockets on front side doors

ASTRO/SAFARI SL

(Passenger Van)

ASTRO CS/SAFARI SLX MODEL—BODY ORDERING CODE YCS

This option includes all exterior items listed for the standard model plus the following additions or substitutions

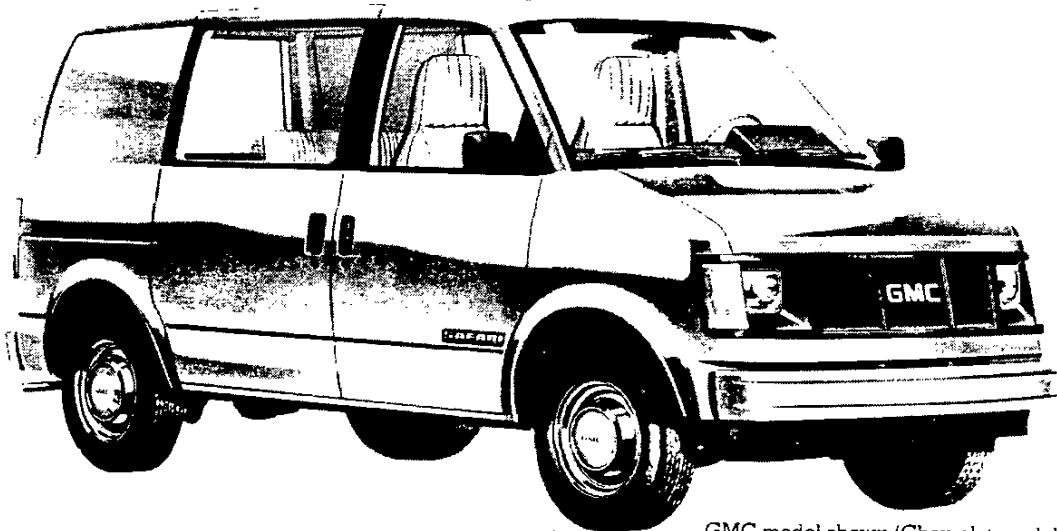

EXTERIOR

GMC model shown (Chevrolet model available)

- **Bright Appearance Items:**
Bright applied Chevrolet emblem/GMC letters at grille center
- **Black Painted Window Pillars**

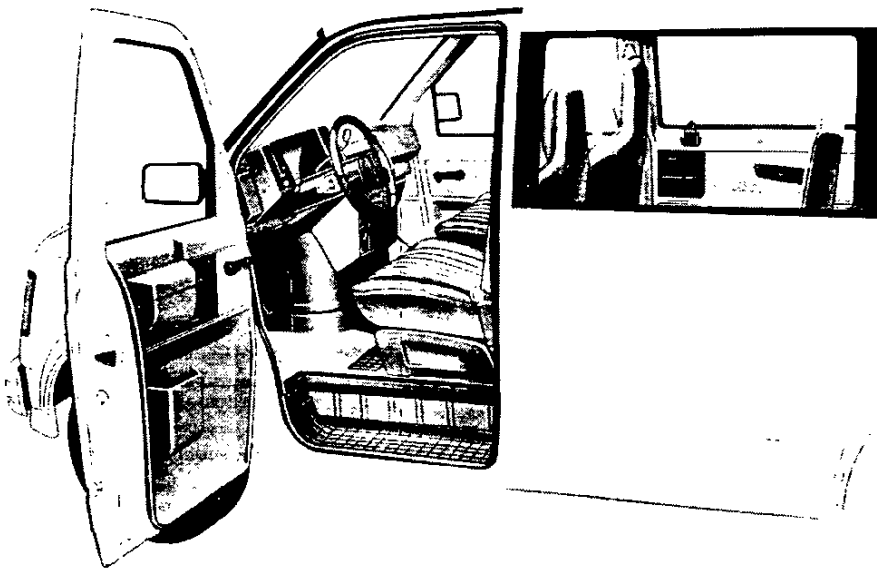

INTERIOR

- **Bright Appearance Items:**
"Astro CS/Safari SLX" lettering and trim on instrument panel
- **Coat Hooks:** LH and RH side, retractable, on roof rails
- **Floor Covering:** Color-keyed rubber mats; for entire floor area, including front and rear wheelhousings
- **Fuel Filler Door:** With remote release
- **Garnish Moldings:** Color-keyed plastic moldings for rear compartment side windows, front and rear roof header panels, roof front side rails and windshield pillars, front door lock pillars, lower sliding door hinge pillar, and sliding door track and roller bracket
- **Headliner:** Full-length, color-keyed; foam-backed cloth
- **Heater and Defogger:** Deluxe air with side window defogger
- **Insulation:** Above headliner and on wheelhousing areas
- **Jack and Tool Cover:** Molded, color-keyed plastic in RH rear quarter area
- **Positive Rear Door Stops**
- **Sill Plates and Stepwell Mats:** Black plastic, on all door openings
- **Spare Tire Carrier:** Under floor
- **Storage Compartment:** Molded, color-keyed plastic in LH rear quarter area
- **Sunshades:** RH and LH color-keyed cloth; with RH visor vanity mirror
- **Trim Panels:** Colored-keyed vinyl on doors and sidewalls with map pockets on front doors

ASTRO/SAFARI SL

(Passenger Van)

ASTRO CL/SAFARI SLE MODEL — BODY ORDERING CODE YC6

This model includes all items listed for Astro CS/Safari SLX model option plus the following additions or substitutions

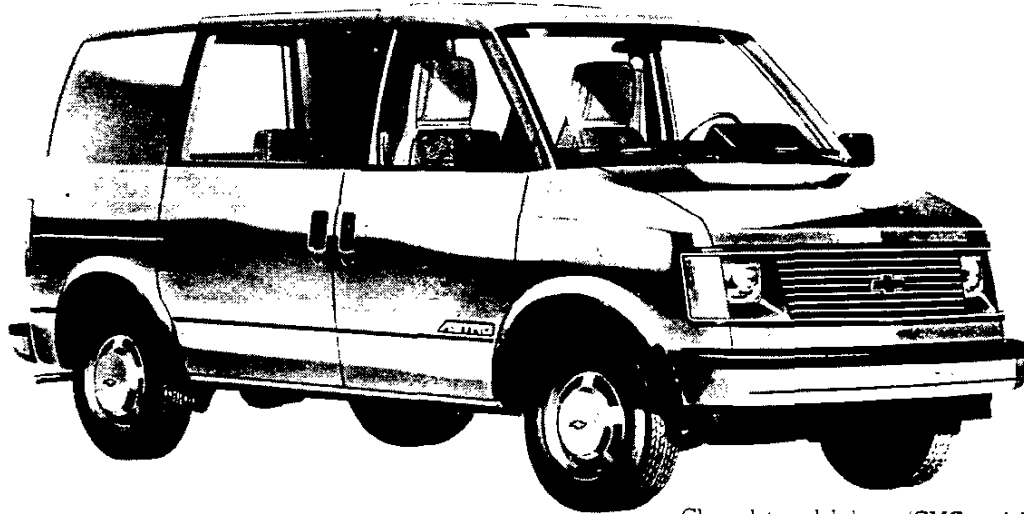

Chevrolet model shown (GMC model available)

EXTERIOR

- **Bumpers:** With end caps and black combination top step surface and rub strip
- **Grille:** Chevrolet—Black with argent paint on feature surfaces with bright applied Chevrolet emblem
GMC—Black with argent paint on feature surfaces and bright applied GMC letters with red paint fill
- **Moldings:** Black body side and wheel opening
- **Wheel Covers:** Bright



INTERIOR

- **Bright Appearance Items:** "Astro CL/Safari SLE" lettering and trim on instrument panel
- **Cigarette Lighter:** With ashtray light
- **Floor Covering:** Color-keyed carpeting; over entire floor area including front and rear wheelhousings; lower portion of engine cover and vertical walls of front and rear side door stepwells
- **Headlamp Warning Chimes**
- **Instrument Cluster:** Voltmeter, oil pressure gage and engine temperature gage replace warning lamps; also includes trip odometer
- **Kick Panels:** Color-keyed with carpet inserts
- **Lights:** Stowage box and convenience tray, step-well lamps
- **Seats:** High-backed driver and front passenger bucket seats, and standard rear passenger seat with choice of: 1) Custom vinyl trim; or 2) Custom cloth/vinyl trim. See Interior and Exterior Color Selection Chart for color and trim availability.
- **Steering Wheel:** Custom
- **Switches:** Dome lamp doorjamb switches for sliding side and rear doors; also includes doorjamb defeat switch
- **Trim Panels:** Color-keyed expanded vinyl with carpet inserts and insulation

ASTRO/SAFARI SL (PASSENGER VAN) BODY CONSTRUCTION FEATURES

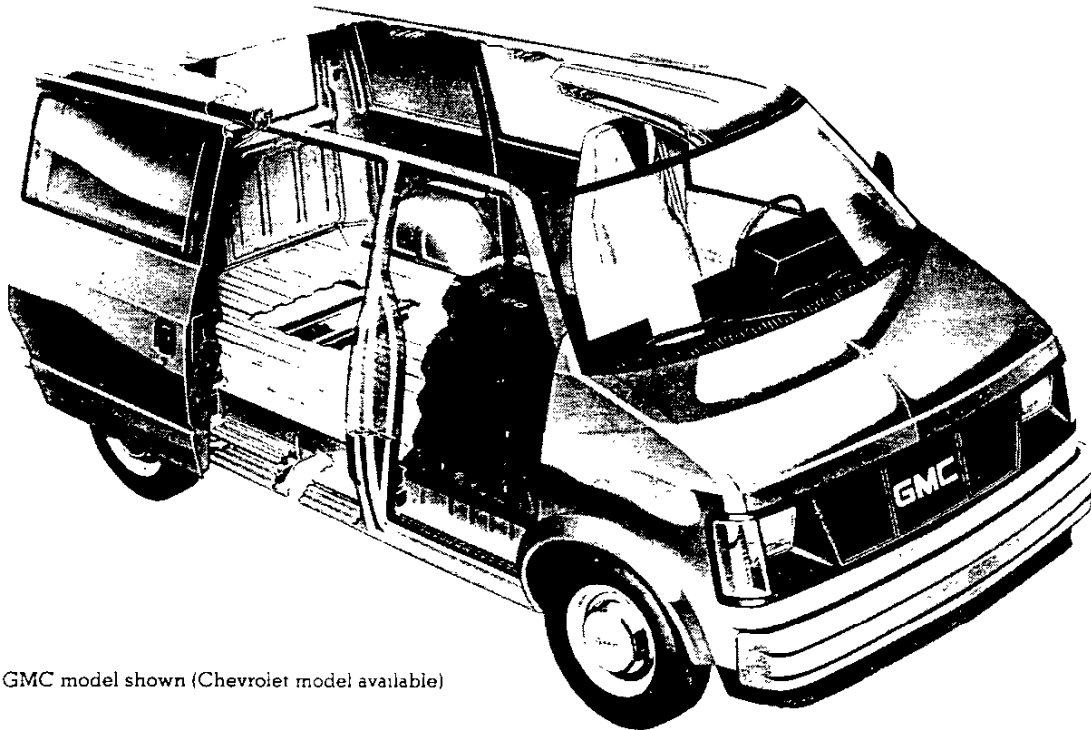

GMC model shown (Chevrolet model available)

BODY CONSTRUCTION FEATURES

- Computer-aided design.
- All-steel construction (except cowl panel).
- Body-frame integral construction for outstanding structural rigidity and excellent durability.
- Comprised of underbody structure, front end structure, left- and right-hand side panel structures and a roof panel structure.
- Longitudinal side rails, cross sills and outriggers form the integral frame to which front and rear floor panels are welded, completing the underbody structure. Main structural members are of heavy-gauge steel. A step well is incorporated in the underbody in the area adjacent to the front doors and sliding side door to provide convenient entry and exit.
- Floor panel provides for available underfloor spare tire carrier.

FRONT END STRUCTURE

- Engine compartment with inside opening hood panel allows quick access to service points such as engine, radiator, brake system, battery and windshield washer reservoir.
- The radiator support upper tie bar is mechanically attached to facilitate engine removal.
- A plenum chamber with high-level air intake is utilized in the front end structure to assure a plentiful supply of dry, outside air for interior heating and ventilating as well as to add rigidity to the overall body structure. Air outlets to the interior are provided on the left-hand and right-hand sides by manually controlled doors (RH door omitted with optional air conditioning).
- Bolt-on front fenders for ease of serviceability.

SIDE PANEL STRUCTURES

- Seamless, one-piece outer panels reinforced with one-piece inner panel construction.
- Roof is welded to side panels.
- Inner side panels are welded to floor panel at bottom, leaving no exterior exposed welds.
- Many window configurations available.
- Front quarter and side door glass available on cargo model, standard on passenger van model.
- Optional rear quarter glass is fixed.
- All window openings are of one-piece stamped construction for excellent fit and corrosion resistance.
- Provision is made at the center of LH side panel for fuel filler door. Inside remote operation of door is available as an option.
- RH side panel incorporates center track for sliding door, providing low operating effort.
- Flush-mounted side glass.

ROOF PANELS

- One-piece design.
- Four longitudinal stiffening ribs.
- Welded to side panels.
- Eliminates exposed drip gutters.
- Center rear surface of panel is free of stiffening ribs to allow roof vent installation.
- Four roof bows support the roof panel.

ADDITIONAL BODY FEATURES

- Completely automated assembly features extensive use of automatic and robotic equipment to weld and assemble body.
- All body openings, front door frames, window frames, windshield frame, rear door frame and side door frame are of one-piece construction for precise fits and excellent corrosion resistance.
- Concealed front door hinges.
- Concealed hood hinges.
- Flush-mounted glass (except front doors).
- Improved body seals (weatherstrips) body mounted at front and side doors.
- On-line water test to eliminate leaks.

Special attention is given to corrosion prevention during the construction and final finishing of the body. The following body design features occur during the construction of the body:

- Use of special steel (galvanized, zinc iron alloy, zinc coated) for body components especially subject to corrosion.
- All exterior body panels (except roof) are two-side galvanized.
- Use of one-piece outer panels, eliminating exterior joints where corrosion might occur.
- Use of heavy-gauge steel for main underbody components.
- One-piece opening frame construction eliminates lap joints and other potential corrosion areas.
- No exposed welds.

After body construction is completed, additional corrosion prevention steps are taken in the final finishing operation.

- The body, doors and hood are thoroughly cleaned through a 7-stage phosphate wash (4 immersion stages, 3 wash stages).
- Next, body, doors and hood are primed by the uni-prime process.
- Sealers are applied to all critical interior/exterior joints.
- The body, doors and hood are painted with base coat/clear coat enamel.
- An anti-chip coating along the lower body sides is added which extends from the rear of the front wheel openings to the rear door openings to prevent stone chipping.
- Hot-wax spray is applied to entire underbody for sound deadening and corrosion resistance.

ASTRO

(Passenger Van)

AVAILABLE WINDOW ARRANGEMENTS

(See Option Section For Restrictions)

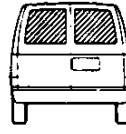
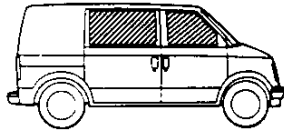
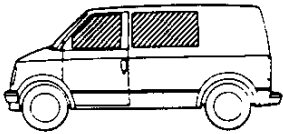

STANDARD
(Includes rear door windows, side sliding door window and LH front quarter window)

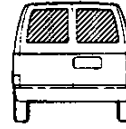
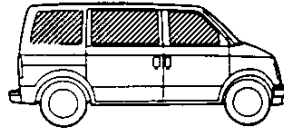
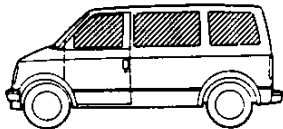

W/ZW6
(Includes RH and LH rear quarter windows)

AVAILABLE SEATING ARRANGEMENTS

(One Seating Arrangement Option Must Be Specified)
(See Option Section For Restrictions)

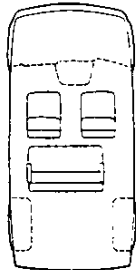

Standard

W/ZP5

Standard 5 person seating: High-Back buckets (2 front) and standard 3-passenger bench seat.

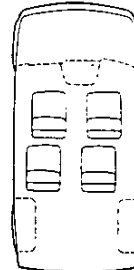

W/ZP4

4 person seating: 4 High-Back buckets (2 front and 2 mid-ship). Not available with standard vinyl trim. Includes A78 reclining seat backs.

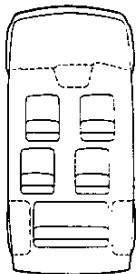

W/ZP7

7 person seating: 4 High-Back buckets and a 3-passenger bench seat. Requires Custom seat trim, P205 tires and LB4 4.3 Liter V6 engine (w/o YC5 or YC6 requires P18 Spare Tire Carrier). Includes A78 reclining seat backs on bucket seats, N40 Power Steering and F59 Front Stabilizer Bar.



W/ZP8

8 person seating: 2 High-Back buckets and 2 3-passenger bench seats. Requires P205 tires and LB4 4.3 Liter V6 engine (w/o YC5 or YC6 requires P18 Spare Tire Carrier). Includes N40 Power Steering and F59 Front Stabilizer Bar.

ASTRO/SAFARI (Passenger Van)

INTERIOR AND EXTERIOR COLOR AVAILABILITY CHART

Please Note: Below are the interior trim color and exterior paint combinations recommended by Chevrolet/GMC. The only available color code 1 color code 2 exterior color combinations are those shown in the chart below, however, any available interior trim color may be ordered with one of these exterior color combinations if that particular combination is desired by the customer.

INTERIOR COLORS		Decor	Teal Blue	Burgundy	Saddle Tan	Slate Gray					
STANDARD INTERIOR ASTRO/SAFARI SL		S10	VDD4	XEE4	XSS4	XTT4					
Vinyl High Back Bucket Seats			XDD4	XEE4	XSS4	XTT4					
Custom Vinyl High Back Bucket Seats			KDD4	KEE4	KSS4	KTT4					
ASTRO CS/SAFARI SLX		YCE	VDD4	XEE4	XSS4	XTT4					
Vinyl High Back Bucket Seats			XDD4	XEE4	XSS4	XTT4					
Custom Vinyl High Back Bucket Seats			KDD4	KEE4	KSS4	KTT4					
ASTRO CL/SAFARI SLE		YCE	XDD4	XEE4	XSS4	XTT4					
Custom Vinyl High Back Bucket Seats			KDD4	KEE4	KSS4	KTT4					
Custom Cloth High Back Bucket Seats											
							ZY1 PAINT OPTIONAL STRIPING CHART RECOMMENDED COMBINATIONS (Requires D85 Body Striping)				
							Additional stripe combinations are available provided the dealer orders (D60) as verification.				
EXTERIOR COLORS w/ZY1 PAINT	Color Code 1	Color Code 2	RECOMMENDED INTERIOR TRIM COLORS				Blue/Silver 25A	Gold/Brown 54A	Red/Black 74A	Red/Silver 71A	Yellow/White 53A
BLACK, SABLE (Metallic)	18	18	X	X	X				X		
BLACK, SABLE (Metallic)	18	18	X			X					
BLACK, SABLE (Metallic)	18	18			X						
BLUE, CARIBBEAN (Metallic)	26	26	X			X					
BLUE, TEAL (Metallic)	25	25	X			X					
BROWN, DARK (Metallic)	69	69			X		X				
GOLD, CALIFORNIA (Metallic)	52	52			X						
GRAY (Metallic)	83	83		X					X		
GRAY (Metallic)	83	83				X		X			
RED, DEEP (Metallic)	75	75		X		X				X	
SILVER, STERLING (Metallic)	15	15		X		X			X		
SILVER, STERLING (Metallic)	15	15	X					X			
SILVER, STERLING (Metallic)	15	15			X		X				
TAN	60	60			X			X			
WHITE, SUMMIT	50	50			X					X	
WHITE, SUMMIT	50	50	X				X				
WHITE, SUMMIT	50	50		X		X					
w/ZY3 or ZY7 PAINT							*STRIPE COLORS (Stripe Colors cannot be changed)				
BLACK, SABLE (Met.)/Silver, Sterling (Met.)	18	15	X	X	X				X		
BLUE, CARIBBEAN (Met.)/Blue, Teal (Met.)	26	25	X			X					
BLUE, TEAL (Met.)/Silver, Sterling (Met.)	25	15	X			X					
BROWN, DARK (Met.)/Silver, Sterling (Met.)	69	15			X				X		
BROWN, DARK (Met.)/Gold, California (Met.)	69	52			X						
GRAY (Met.)/Silver, Sterling (Met.)	83	15		X		X		X			
RED, DEEP (Met.)/Silver, Sterling (Met.)	75	15		X		X			X		
SILVER, STERLING (Met.)/Gray (Met.)	15	83		X		X			X		
TAN/Gold, California (Met.)	60	52			X					X	
WHITE, SUMMIT/Blue, Teal (Met.)	50	25	X				X				
WHITE, SUMMIT/Gold, California (Met.)	50	52			X			X			
WHITE, SUMMIT/Gray (Met.)	50	83		X		X			X		

*D85 required if stripe is desired w/ZY7 Paint. Stripe is included w/ZY3 Paint.

ASTRO/SAFARI SL (Passenger Van)

SOLID AND TWO-TONE* EXTERIOR COLOR COMBINATIONS

The application of paint for solid and two-tone exterior color combinations is shown below.

SOLID COLOR

Solid paint (ZY1) is standard on all models (except Sport/Gypsy). All painted areas of the body and front end sheet metal including the bumpers, are the same color.

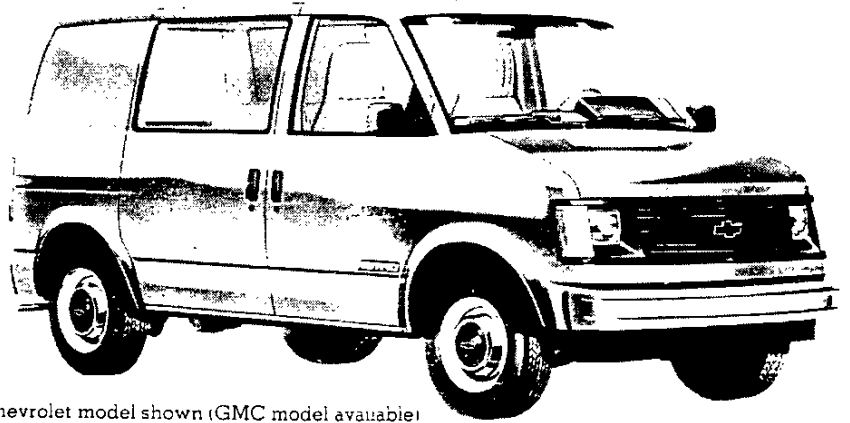

Chevrolet model shown (GMC model available)

SPECIAL TWO-TONE

Special two-tone paint (ZY3) is available on all models and includes a dual color decal stripe located at the belt styling crease line. The areas above the decal are painted color code 1. The areas below the decal, including the bumpers, are painted color code 2.

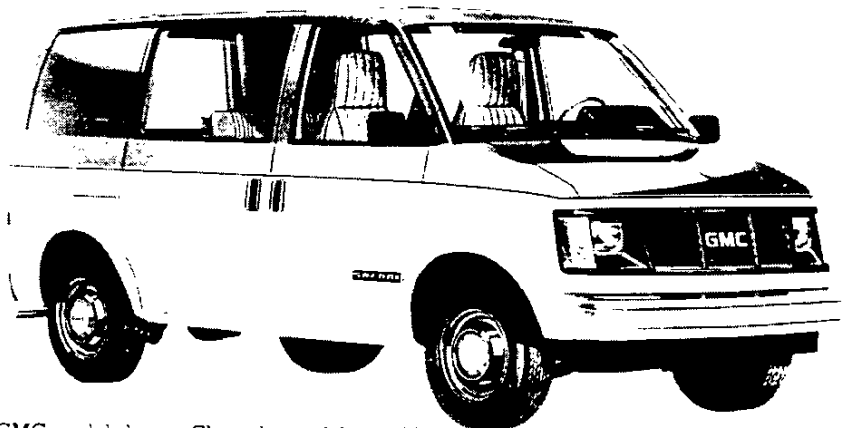

GMC model shown (Chevrolet model available)

SPORT TWO-TONE

Sport two-tone paint (ZY7), which provides a lower accent two-tone scheme, is available on all models. Color code 1 is applied to the areas above the lower styling crease line and color code 2 is applied to the areas below, including the bumpers and fender flares.

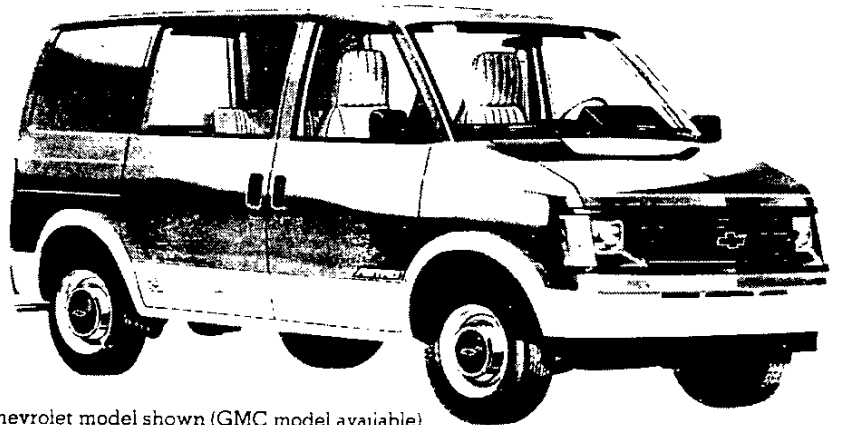

Chevrolet model shown (GMC model available)

*Optional at extra cost

NOTES

ASTRO/SAFARI
(Cargo Van)
ASTRO/SAFARI CARGO VAN MODEL SELECTOR

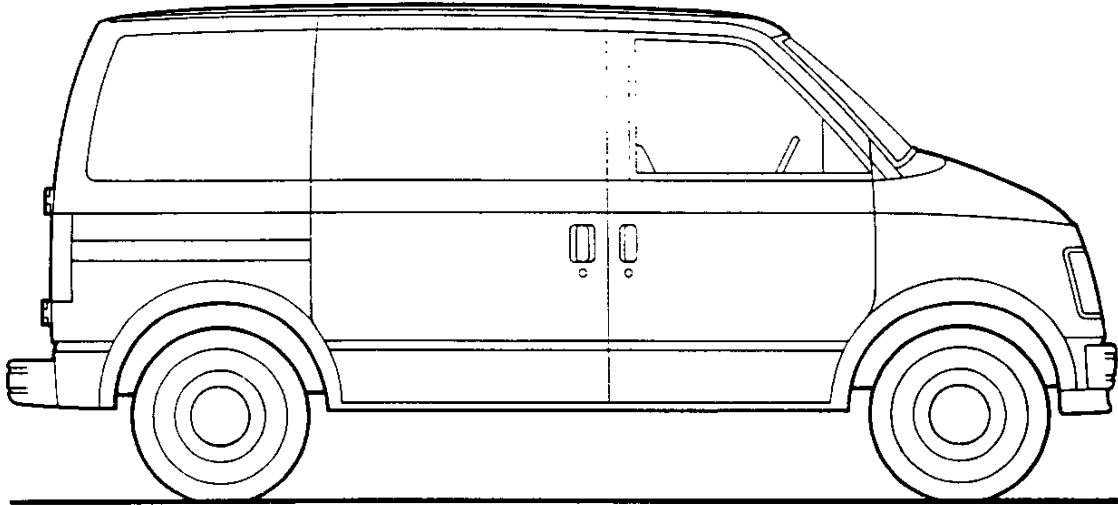

SERIES	MODEL NUMBER	BODY ORDERING CODE
M10	M10905	ZW9

ASTRO/SAFARI

(Cargo Van)

STANDARD SPECIFICATIONS

(See Gray Tab Section for Specification Details)

Series	M10
Engine Base Equip. Clutch Air Filter Oil Filter Exhaust System Emission Control Systems	2.5 Liter (151 Cu. In.), EFI L4 9.13; 71.86 sq. in. Oiled-paper Element Throwaway Type Single Aluminized See Engine & Cooling Section for specific model applications
Suspension, Front Type Axle Capacity Axle Ratio Springs @ Ground Shock Absorbers Stabilizer Bar	Independent Coil Springs 2700 lb. — 1350 lb. ea. 25mm dia. 1.10" dia.
Suspension, Rear Type Axle Capacity Axle Ratio Springs, Main @ Ground Shock Absorbers	Salisbury Axle; Hypoid Drive; Variable Rate Leaf Springs Composite Single Leaf Springs 2900 lb. 3.42 1245 lb. ea. 25mm dia.
Brakes Front Rear Parking	Hydraulic; Self-adjusting Disc; 12" Rotor Drum; 9.49" x 2" Cable to Rear Wheels
Electrical Battery – Freedom Type – Reserve Capacity Delcotron Generator	12 Volt; Negative Ground 405 CCA ♦ @ 0°F. 75 min. @ 80°F. 85 amp.
Frame	Integral Body-frame with Box Section Front Stub Frame
Fuel Tank (nominal capacity)	17 gal.
Steering Gear Type Linkage	Manual; Recirculating Ball Gear Parallelogram
Transmission Shift Location	4-Speed Manual Floor
Tires Spare	(4) P195/75R15 (All Seasons Steel Belted Radial) (1) T145/80D16
Wheels Spare	(4) Disc, 15" x 6" (1) Disc, 16" x 4"

♦ CCA-Cold Cranking Amps

ASTRO/SAFARI

(Cargo Van)

Body Ordering Codes—ZW9

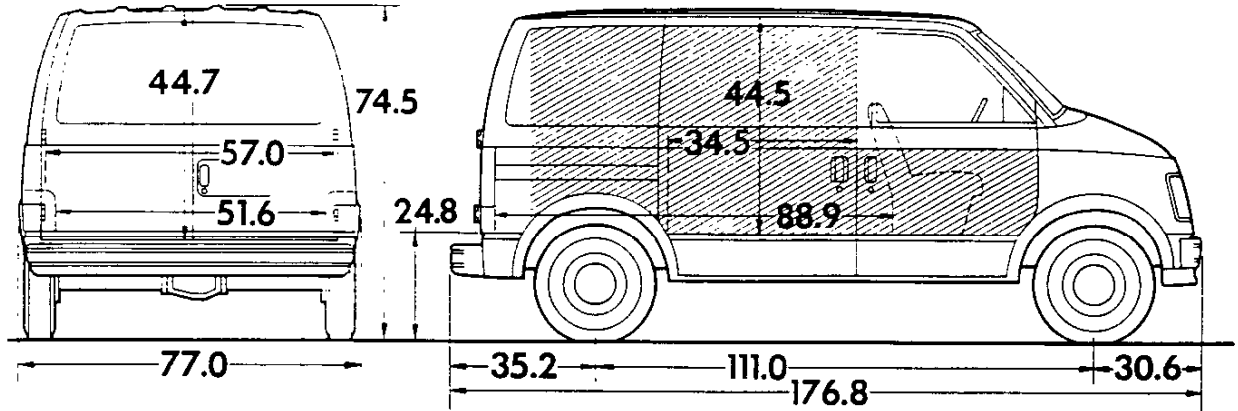

Sign Panel Area (side)

Side Panel—36" x 72"
Door—18" x 35"



Capacity (Cu. Ft.)

w/Std.—189.9
w/2-Pass.—153.9
w/4-Pass.—86.2

Model	Body Ordering Code	Engine No. Cyl.	Curb Weight (lb)			Model Weights (lb)*			Ground Clearance (in)★
			Front	Rear	Total	Front	Rear	Total	Minimum
M10905	ZW9	4	1749	1329	3078	1842	1386	3228	7.8

★ Dimensions with standard equipment, unloaded.

*Model Weights include curb weight plus occupants (standard seating capacity x 150 lbs.). Total Weight may vary as much as ±50 lbs. to allow for production build variation.

PAYLOAD SELECTOR

±Maximum Ratings				Minimum Equipment Required for GVW Rating		
Payload (lb)	GVW Range (lb)	+GAWR (lb)		Tires, Front	Tires, Rear	Chassis Equipment
		Front	Rear			

M10905 MODELS

1000	4091 to 4958	2685	2490	P195/75R15	P195/75R15	Standard
1350	4448 to 5309	2685	2490▲	P195/75R15	P195/75R15	1350-lb Payload Package (X8F)
1700	5006 to 5659	2700	2900	P205/75R15	P205/75R15	1700-lb Payload Package (X8H); 4.3L V6 Engine (LB4)

±GAWRs shown are the maximum for each axle with the equipment listed. Maximum ratings include an additional 50 lbs. allowance for vehicle weight variance.

+GAWR—Gross Axle Weight Rating.

▲2685 with 4.3L V6 engine.

ASTRO/SAFARI

(Cargo Van)

POWER TEAMS

ALL STATES

■ **PAYLOADS:**
C3B: 1000 lbs.
X8F: 1350 lbs.
X8H: 1700 lbs.

POWER TEAMS (MUST ORDER ENGINE, TRANSMISSION AND REAR AXLE)

ENGINE	TRANSMISSION			AXLES						PAYLOAD
	4-SP	5-SP	AUTO	2.56	2.73	3.08	3.42	3.73	4.10	
W/NA5 STANDARD EMISSION EQUIPMENT										
LN8 L4 2.5 Liter EFI	MM4			—	—	—	GQ1	GT4	—	w/C3B
		MM5	MX0	—	—	—	—	GQ1	GT5	w/C3B
	MM4	MM5		—	—	—	—	GQ1	GT5	w/X8F
			MX0	—	—	—	—	—	GQ1	w/X8F
LB4 V6 4.3 Liter EFI (Reqs J50 Brakes)			MX0	—	GQ1	GU4	*GU6	*GT4	—	ALL
W/NA6 HIGH ALTITUDE EMISSION EQUIPMENT										
LN8 L4 2.5 Liter EFI	MM4	MM5	MX0	—	—	—	—	GQ1	GT5	w/C3B
	MM4	MM5		—	—	—	—	GQ1	GT5	w/X8F
			MX0	—	—	—	—	—	GQ1	w/X8F
LB4 V6 4.3 Liter EFI (Reqs J50 Brakes)			MX0	—	—	GQ1	GU6	*GT4	—	ALL
W/YF5 CALIFORNIA EMISSION REQUIREMENTS										
LN8 L4 2.5 Liter EFI	MM4	MM5	MX0	—	—	—	—	GQ1	GT5	w/C3B
	MM4	MM5		—	—	—	—	GQ1	GT5	w/X8F
			MX0	—	—	—	—	—	GQ1	w/X8F
LB4 V6 4.3 Liter EFI (Reqs J50 Brakes)			MX0	—	GQ1	GU4	*GU6	*GT4	—	w/C3B
			MX0	—	—	GQ1	GU6	*GT4	—	N/A C3B

*Reqs Z82 Trailering

ENGINE RATINGS—ALL STATES

SAE Net Ratings	2.5 Liter 151 EFI L4	4.3 Liter 262 EFI V6
Net Horsepower	92 @ 4400 rpm	145 @ 4000 rpm
Net Torque, lb-ft	134 @ 2800 rpm	230 @ 2400 rpm

ASTRO (CARGO VAN)

(1000-LB-1700-LB Payload)

1986 VEHICLES WITH STANDARD EQUIPMENT

Prices shown are effective with initial shipments of 1986 model motor vehicles

Description	Model Number	Body Code	Wheel Base	Factory D&H(a)	List Price	Mfr's Suggested Retail Price★	Group Number
◆ 4-Cylinder 2.5 Liter (151 Cu. In.) E.F.I. L4 Gasoline Engine-Engine Ordering Code LN8							
M10 Series							
Astro	CM10905	ZW9	111"	N.A.	8056.00	8056.00	13

★ Manufacturer's Suggested Retail Prices do not include applicable destination charges, state and local taxes, license fees, optional equipment or special items or services.

◆ Refer to Dealer Order Guide for California Requirements.

OPTIONS WHEN INSTALLED BY GENERAL MOTORS

Prices shown are effective with initial shipments of 1986 model motor vehicles

Description	Option Number	Factory D&H(a)	List Price	Mfr's Suggested Retail Price○
Seat Trim: (See Interior and Exterior Color Selection Chart for ordering information).				
V**2 Standard Vinyl Low-Back Bucket				NO ADDITIONAL CHARGE
V**4 Standard Vinyl High Back Bucket. Available only when ZX2 Seating Arrangement is specified				NO ADDITIONAL CHARGE
X**4 Custom Vinyl High Back Bucket.				
With ZP4 Seating Arrangement				NO ADDITIONAL CHARGE
With ZX2 Seating Arrangement		N.A.	50.00	50.00
K**4 Custom Cloth High Back Bucket.				
With ZP4 Seating Arrangement				NO ADDITIONAL CHARGE
With ZX2 Seating Arrangement		N.A.	50.00	50.00
Paints, Exterior: (See Interior and Exterior Color Selection Chart for Ordering Information and Paint Application).				
Solid	ZY1			NO ADDITIONAL CHARGE
Special Two-Tone. Includes D85 striping	ZY3	N.A.	237.00	237.00
Sport Two-Tone.	ZY7	N.A.	162.00	162.00
Emission Systems: Dealer Note - One of the following emission options must be specified. (See Power Teams Chart for availability and complete specifications)				
California Emission Requirements. Includes all testing, equipment and/or certification necessary for registration in the State of California. Not available when NA6 High Altitude or NA5 Standard Emissions is specified.	YF5	N.A.	99.00	99.00
High Altitude Emission Equipment. Not available when YF5 California Emissions are specified	NA6			NO ADDITIONAL CHARGE
Standard Emission Equipment. Not available when YF5 California or NA6 High Altitude Emissions are specified	NA5			NO ADDITIONAL CHARGE
Engines: (See Power Teams Chart for availability and complete specifications)				
Gasoline.				
2.5 Liter (151 Cu. In.) E.F.I. L4. (Standard)	LN8			NO ADDITIONAL CHARGE
4.3 Liter (262 Cu. In.) E.F.I. V6. Available only when J50 Brakes, X8F or X8H Payload Capacity is specified	LB4	N.A.	375.00	375.00
Transmissions:				
4-Speed Automatic with Overdrive.	MX0	N.A.	695.00	695.00
4-Speed Manual. (Standard) Not available when LB4 4.3 Liter Engine is specified	MM4			NO ADDITIONAL CHARGE
5-Speed Manual with Overdrive. Not available when LB4 4.3 Liter Engine is specified	MM5	N.A.	175.00	175.00
Axles, Rear: (See Power Teams Chart for option number selection, availability and complete specifications)				
Optional Ratio		N.A.	36.00	36.00
Locking Differential. Includes T155/90 D16 Compact Spare Tire	G80	N.A.	238.00	238.00

(a) D & H Charges on vehicle and optional equipment include reimbursement to ordering Division for any tax that it has paid, incurred or agreed to pay thereon.
State and local taxes not included.

ASTRO/SAFARI (CARGO VAN)

OPTIONS WHEN INSTALLED BY GENERAL MOTORS

Prices shown are effective with initial shipments of 1986 model motor vehicles

Description	Option Number	Factory D&H(a)	List Price	Mfr's Suggested Retail Price ^o
Tires:				
<i>All rim sizes are 6.00" except when ZJ7 Rally Wheels are specified.</i>				
TUBELESS. Includes Compact Spare Tire.				
P195/75R15 All Seasons Steel Belted Radial Ply Blackwall. (Standard) (Maximum Capacity 1342-lbs)	QAR	NO ADDITIONAL CHARGE		
P195/75R15 All Seasons Steel Belted Radial Ply Whitewall (Maximum Capacity 1342-lbs)	QAS	N.C.	64.00	64.00
P195/75R15 Highway Fiberglass Belted Radial Ply Blackwall (Maximum Capacity 1342-lbs)	QYP	NO ADDITIONAL CHARGE		
P205/75R15 All Seasons Steel Belted Radial Ply Blackwall (Maximum Capacity 1453-lbs)	QCE	N.C.	31.00	31.00
P205/75R15 All Seasons Steel Belted Radial Ply Whitewall (Maximum Capacity 1453-lbs)	QCG	N.C.	99.00	99.00
P205/75R15 All Seasons Steel Belted Radial Ply White Lettered (Maximum Capacity 1453-lbs)	QCF	N.C.	122.00	122.00

OTHER OPTIONS

Air Conditioning: All Weather. Front. Instrument panel mounted. Includes V01 H.D. Radiator when V02 H.D. Radiator and Transmission Oil Cooler is not specified.	C60	N.A.	740.00	740.00
Battery: Heavy-Duty. 12-Volt, 515 Cold Cranking Amps Delco Freedom. Included with V10 Cold Climate Package . .	UA1	N.A.	53.00	53.00
Brakes: Vacuum Power. Included with X8F 1350-lb or X8H 1700-lb Payload Capacity	J50	N.A.	95.00	95.00
Bumper Equipment:				
<i>Bumpers, Deluxe Front and Rear.</i> Chromed with color-keyed end caps and black rub strips	VE5	N.A.	122.00	122.00
<i>Bumpers, Front and Rear.</i> Color-Keyed with color-keyed end caps and black rub strips.	VE6	N.A.	50.00	50.00
Carrier, Spare Tire: Includes hoist	P18	N.A.	21.00	21.00
Cooling Systems:				
Engine Oil. Available only when LB4 4.3 Liter Engine and V01 H.D. Radiator or V02 H.D. Radiator and Transmission Oil Cooler are specified. Included with Z82 Trailing Special.	KC4	N.A.	120.00	120.00
Radiator, Heavy Duty. Included when C60 Air Conditioning is specified without V02 H.D. Radiator and Transmission Oil Cooler	V01	N.A.	53.00	53.00
Radiator and Transmission Oil, Heavy-Duty. Available only when LB4 4.3 Liter Engine and MXO Automatic Transmission are specified. Not Available when V01 H.D. Radiator is specified Included with Z82 Trailing Special				
Without C60 Air Conditioning	V02	N.A.	112.00	112.00
With C60 Air Conditioning	V02	N.A.	59.00	59.00
Cold Climate Package: Includes K05 Engine Block Heater, UA1 H.D. Battery, K60 100-Amp Generator, anti-freeze protection to -32 degrees.				
Without ZP4 Seating Arrangement				
Without C60 Air Conditioning. Includes Z6Z Floor Covering and C42 Deluxe Heater and Defogger	V10	N.A.	296.00	296.00
With C60 Air Conditioning. Includes Z6Z Floor Covering	V10	N.A.	253.00	253.00
With ZP4 Seating Arrangement				
Without C60 Air Conditioning. Includes C42 Deluxe Heater and Defogger	V10	N.A.	171.00	171.00
With C60 Air Conditioning	V10	N.A.	128.00	128.00
Console, Roof: Available only when TR9 Auxiliary Lighting is specified Includes dome lamp, map lamps and two stowage compartments				
	DK6	N.A.	79.00	79.00
Door Lock System, Power: All Doors. Included when ZQ2 Operating Convenience Package is specified				
	AU3	N.A.	198.00	198.00

(a) D & H Charges on vehicle and optional equipment include reimbursement to ordering Division for any tax that it has paid, incurred or agreed to pay thereon.
^o State and local taxes not included.

ASTRO/SAFARI (CARGO VAN)

OPTIONS WHEN INSTALLED BY GENERAL MOTORS

Prices shown are effective with initial shipments of 1986 model motor vehicles

Description	Option Number	Factory D&H(a)	List Price	Mfr's Suggested Retail Price (c)
OTHER OPTIONS				
Filler Door, Fuel: Inside remote release	N08	N.A.	25.00	25.00
Floor Covering: Rubber, Wheelhousing and Floor. Color-Keyed. Available only when ZP2, ZP4 or ZX2 Seat arrangements are specified.				
Without ZP4 Seating or V10 Cold Climate Package	BG9	N.A.	168.00	168.00
With ZP4 Seating or V10 Cold Climate Package	BG9	N.A.	43.00	43.00
Black. Included with ZP4 Seating or V10 Cold Climate Package	Z6Z	N.A.	125.00	125.00
Gages: Voltmeter, Temperature, Oil Pressure and Trip Odometer	Z53	N.A.	58.00	58.00
Generator: 100-Amp Delcotron. Included when V10 Cold Climate Package is specified	K60	N.A.	30.00	30.00
Glass Arrangements:				
Complete Body. Available only when P18 Spare Wheel Carrier is specified				
Without A01, AA3 or AJ1 Tinted Glass	ZW6	N.A.	295.00	295.00
With A01 Tinted Glass	ZW6	N.A.	393.00	393.00
With AA3 Deep Tinted Glass	ZW6	N.A.	588.00	588.00
With AJ1 Deep Tinted Glass	ZW6	N.A.	640.00	640.00
Rear Panel Doors				
Without A01 or AJ1 Tinted Glass	ZW2	N.A.	73.00	73.00
With A01 Tinted Glass	ZW2	N.A.	126.00	126.00
With AJ1 Deep Tinted Glass	ZW2	N.A.	178.00	178.00
Sliding Door and Rear Panel Doors				
Without A01, AA3 or AJ1 Tinted Glass	ZW3	N.A.	128.00	128.00
With A01 Tinted Glass	ZW3	N.A.	191.00	191.00
With AA3 Deep Tinted Glass	ZW3	N.A.	241.00	241.00
With AJ1 Deep Tinted Glass	ZW3	N.A.	293.00	293.00
Sliding Door, Rear Panel Doors and Right Rear Quarter				
Without A01, AA3 or AJ1 Deep Tinted Glass	ZW4	N.A.	188.00	188.00
With A01 Tinted Glass	ZW4	N.A.	259.00	259.00
With AA3 Deep Tinted Glass	ZW4	N.A.	361.00	361.00
With AJ1 Deep Tinted Glass	ZW4	N.A.	413.00	413.00
Sliding Door, Rear Panel Doors and Left Front Quarter				
Without A01, AA3 or AJ1 Tinted Glass	ZX4	N.A.	183.00	183.00
With A01 Tinted Glass	ZX4	N.A.	254.00	254.00
With AA3 Deep Tinted Glass	ZX4	N.A.	356.00	356.00
With AJ1 Deep Tinted Glass	ZX4	N.A.	408.00	408.00
Glass, Swing Out:				
Swing-Out Rear Door. Available only when ZW2, ZW3, ZW4, ZW6 or ZX4 Glass is specified.	A18	N.A.	55.00	55.00
Swing-Out Sliding Door. Available only when ZW3, ZW4, ZW6 or ZX4 Glass is specified. Included with A17 Swing-Out Glass	A19	N.A.	73.00	73.00
Swing-Out, Left Front Quarter. Available only when ZW6 or ZX4 Glass is specified. Includes A19 Swing-Out Sliding Door Glass	A17	N.A.	146.00	146.00
Glass, Tinted:				
All Windows. Includes A02 Windshield Glass	A01	N.A.	45.00	45.00
Windshield only. Included when A01 Tinted, AA3 Deep Tinted or AJ1 Deep Tinted Glass is specified	A02	N.A.	38.00	38.00
Deep Tinted. Not available when A01 Tinted Glass is specified. Available only when ZW2, ZW3, ZW4, ZW6 or ZX4 Glass is specified. Includes tinted glass on passenger and driver's side door. Also includes A02 Windshield Glass and dark coated glass on side windows and rear door.	AJ1	NO ADDITIONAL CHARGE		
Deep Tinted with Light Tinted Rear Window. Available only when ZW3, ZW4, ZW6 or ZX4 Glass is specified. Not available when A01 Tinted or AJ1 Deep Tinted Glass is specified. Includes tinted glass on passenger, driver's side and rear doors. Also includes A02 Tinted Windshield and dark coated glass on side windows.	AA3	NO ADDITIONAL CHARGE		

(a) D & H Charges on vehicle and optional equipment include reimbursement to ordering Division for any tax that it has paid, incurred or agreed to pay thereon.

◇ State and local taxes not included.

ASTRO/SAFARI (CARGO VAN)

OPTIONS WHEN INSTALLED BY GENERAL MOTORS

Prices shown are effective with initial shipments of 1986 model motor vehicles

Description	Option Number	Factory D&H(a)	List Price	Mfr's Suggested Retail Price ◊
OTHER OPTIONS				
Grille, Deluxe: Black with Argent Trim	TL1	N.A.	25.00	25.00
Harness, Wiring: Trailer, 5-lead. Not Available when Z82 Trailering Special is specified. Included with Z72 Trailering Special	U89	N.A.	39.00	39.00
Headlamps: Halogen	TT4	N.A.	22.00	22.00
Heaters:				
Engine Block, 600 Watts, 120 Volts. Included when V10 Cold Climate Package is specified	K05	N.A.	31.00	31.00
Rear. Located on left side, forward of rear fender well	C36	N.A.	256.00	256.00
Deluxe, Heater and Defogger. Not available when C60 Air Conditioning is specified. Included with V10 Cold-Climate Package	C42	N.A.	43.00	43.00
Key Unit: Separate keys for side and rear cargo doors	AU2	N.A.	8.00	8.00
Lamp: Dome and Reading. Available only when TR9 Auxiliary Lighting is specified. Not Available when DK6 Roof Console is specified	C95	N.A.	31.00	31.00
Lighter, Cigarette: Includes ash tray lamp. Included with TR9 Auxiliary Lighting	U37	N.A.	30.00	30.00
Lighting, Auxiliary: Available only when ZP2, ZP4 or ZX2 Seating Arrangement is specified. Includes headlamp warning chimes, U37 Cigarette Lighter, glove compartment and convenience tray lights, door jamb switches on all doors, stepwell lamps for front and sliding doors and door jamb defeat switch	TR9	N.A.	142.00	142.00
Mirror, Exterior: Deluxe. LH and RH. Below Eye-Line. Painted, Black	D44	N.A.	50.00	50.00
Moldings:				
Body Side, Black	B84	N.A.	55.00	55.00
Wheel Opening, Black	B96	N.A.	29.00	29.00
Guards, Door Edge, Black	B93	N.A.	17.00	17.00
Operating Convenience Package: Includes AU3 Power Door Locks and A31 Power Windows	ZQ2	N.A.	388.00	388.00
Panels, Interior: Protective closeout for Lower Quarter	E48	N.A.	25.00	25.00
Payload Capacities:				
1000-Lbs Capacity (Standard)	C3B	NO ADDITIONAL CHARGE		
1350-Lbs. Capacity. Includes J50 Power Brakes				
With LN8 2.5 Liter Engine	X8F	N.A.	95.00	95.00
With LB4 4.3 Liter Engine. Also includes H.D rear springs	X8F	N.A.	153.00	153.00
1700-Lbs. Capacity. Includes J50 Power Brakes, N40 Power Steering, H.D. rear springs and F59 Front Stabilizer. Available only when P205 Tires are specified	X8H	N.A.	467.00	467.00
Preliminary Price Information	B3W	N.A.	N.A.	N.A.
Radio Equipment:				
AM Radio. Includes dual front speakers	U63	N.A.	112.00	112.00
AM/FM Radio. Includes dual front speakers	U69	N.A.	171.00	171.00
AM/FM Stereo Radio. Electronically Tuned. Includes dual front speakers and wiring for rear speakers	UU9	N.A.	243.00	243.00
AM/FM Stereo Radio with Seek and Scan and Digital Clock. Electronically Tuned. Includes dual front speakers and wiring for rear speakers	UM7	N.A.	302.00	302.00
AM/FM Stereo Radio with Seek and Scan, Stereo Cassette Tape and Digital Clock. Electronically Tuned. Includes dual front speakers and wiring for rear speakers	UM6	N.A.	424.00	424.00
AM Stereo and FM Stereo Radio with Seek and Scan, Stereo Cassette Tape with Search and Repeat, Graphic Equalizer, and Digital Clock. Electronically Tuned. Includes dual front speakers and wiring for rear speakers	UX1	N.A.	574.00	574.00

(a) D & H Charges on vehicle and optional equipment include reimbursement to ordering Division for any tax that it has paid, incurred or agreed to pay thereon.

◊ State and local taxes not included.

ASTRO/SAFARI (CARGO VAN)
OPTIONS WHEN INSTALLED BY GENERAL MOTORS
 Prices shown are effective with initial shipments of 1986 model motor vehicles

Description	Option Number	Factory D&H(a)	List Price	Mfr's Suggested Retail Price ◊
OTHER OPTIONS				
Seats: One of the following seat options must be specified. (Added weight reflects optional seat weight only. Refer to vehicle and option weight section of Data Book.)				
Low-Back Bucket Seat. Driver only. Standard. Not available when Custom Trim is specified	ZP1			NO ADDITIONAL CHARGE
Low-Back bucket seats. Driver and Passenger only. Includes D20 Sunshade. Available only when VDD2 or VSS2 Trim Codes are specified	ZP2	N.A.	175.00	175.00
High Back Bucket Seats. Driver and Passenger only. Includes D20 Sunshade.	ZX2	N.A.	237.00	237.00
High Back Bucket Seats. 2-front and 2-midship. Includes D20 Sunshade, Z6Z Floor Covering, seat adjusters, belts, A78 Seat Back Recliners and Dual Armrests on all seats. Available only when Custom Trim is specified	ZP4	N.A.	1234.00	1234.00
Seat Back Recliner and Dual Armrests: For high back driver and front passenger seats only. Available only when Custom Trim and ZX2 Seating is specified. Included with ZP4 Four High Back Bucket Seats	A78	N.A.	230.00	230.00
Shock Absorbers: Heavy Duty. Front and Rear	F51	N.A.	34.00	34.00
Speed Control, Electronic	K34	N.A.	195.00	195.00
Stabilizer Bar: Front. Included with X8H 1700-lb Payload Capacity	F59	N.A.	38.00	38.00
Steering:				
Power. Available only when F59 Stabilizer Bar is specified. Included with X8H 1700-lb Payload	N40	N.A.	276.00	276.00
Power, Not Desired	N51			NO ADDITIONAL CHARGE
Steering, Wheels:				
Comfortilt	N33	N.A.	115.00	115.00
Custom	N31	N.A.	26.00	26.00
Stop, Positive: Rear Door	AD8	N.A.	35.00	35.00
Storage Compartments: Front Seats Only. Includes compartment door, lock and separate key Not available with ZP1 Seating Arrangement				
L.H. and R.H. only. Includes BA9 Storage Compartment	BA8	N.A.	70.00	70.00
L.H. only. Included with BA8 Storage Compartments	BA9	N.A.	35.00	35.00
Striping, Body: With ZY1 Solid Paint available only when the following stripe color is specified. Included with ZY3 Special Two-Tone Paint	D85	N.A.	75.00	75.00
Stripe Color: Available only when ZY1 Solid Paint and D85 Striping is specified. (Refer Color and Trim Chart for option availability)				
Blue with Silver Border	25A			NO ADDITIONAL CHARGE
Gold with Brown Border	54A			NO ADDITIONAL CHARGE
Red with Black Border	74A			NO ADDITIONAL CHARGE
Red with Silver Border	71A			NO ADDITIONAL CHARGE
Yellow-Orange with White Border	53A			NO ADDITIONAL CHARGE
Sunshade, Passenger: Included with ZP2, ZP4 or ZX2 Seat Arrangement	D20	N.A.	19.00	19.00
Tank, Fuel: Approximately 27-gallon capacity. Replaces production fuel tank	NL9	N.A.	66.00	66.00
Trailer Hitch: Deadweight Type. Not available when Z82 Trailing Special is specified. Included with Z72 Trailing Special	VR2	N.A.	64.00	64.00

(a) D & H Charges on vehicle and optional equipment include reimbursement to ordering Division for any tax that it has paid, incurred or agreed to pay thereon.
 ◊ State and local taxes not included.

ASTRO/SAFARI (CARGO VAN)

OPTIONS WHEN INSTALLED BY GENERAL MOTORS

Prices shown are effective with initial shipments of 1986 model motor vehicles

Description	Option Number	Factory D&H(a)	List Price	Mfr's Suggested Retail Price ◊
OTHER OPTIONS				
Trailer Special Equipment: (See Trailing Guide for GCW Ratings with available power team combinations.)				
<i>Heavy-Duty.</i> Includes Weight Distributing Hitch Platform, H.D. 7 Lead Wiring Harness, KC4 Engine Oil Cooler and V02 H.D. Radiator and Transmission Oil Cooler. Available only when N40 Power Steering, J50 Brakes, UA1 H.D. Battery, F51 H.D. Shock Absorbers, F59 Stabilizer, MX0 Automatic Transmission, LB4 4.3 Liter V6 Engine are specified. Available only when 3.42 or 3.73 Rear Axle Ratio is specified.				
Without C60 Front Air Conditioning	Z82	N.A.	524.00	524.00
With C60 Front Air Conditioning	Z82	N.A.	471.00	471.00
<i>Light-Duty.</i> Includes VR2 Deadweight Trailer Hitch, H.D. Flashers and U89 5 Lead Wiring Harness. Available only when MX0 Automatic Transmission, J50 Brakes and V01 H.D. Radiator or V02 H.D. Radiator and Transmission Oil Cooler are specified. LN8 2.5 Liter Engine available only when 4.10 Rear Axle Ratio is specified. LB4 4.3 Liter Engine available only when 3.08 Rear Axle Ratio is specified				
	Z72	N.A.	103.00	103.00
Wheel Trim:				
<i>Wheel Covers, Bright Metal.</i> Includes black wheel	P01	N.A.	40.00	40.00
<i>Trim Rings.</i> Includes black wheel. Included with ZJ7 Rally Wheels	P06	N.A.	56.00	56.00
Wheels:				
<i>Rally, 6.5". Argent.</i> Includes special hub caps and P06 Trim Rings	ZJ7	N.A.	88.00	88.00
<i>Aluminum, Cast.</i> Four Wheels only. Includes 15" x 6.5" wheels and special hub caps	PF3	N.A.	299.00	299.00
Windows: Power. Front side doors only. Included when ZQ2 Operating Convenience Package is specified				
	A31	N.A.	190.00	190.00
Windshield Wiper System: Intermittent				
	CD4	N.A.	55.00	55.00

(a) D & H Charges on vehicle and optional equipment include reimbursement to ordering Division for any tax that it has paid, incurred or agreed to pay thereon.
 ◊ State and local taxes not included.

ASTRO/SAFARI

CAB & BODY FEATURES SEATING ARRANGEMENTS COLOR & TRIM CHARTS TWO-TONES

ASTRO/SAFARI

(Cargo Van)

STANDARD MODEL—BODY ORDERING CODE—ZW9

The standard model includes the following items as standard equipment

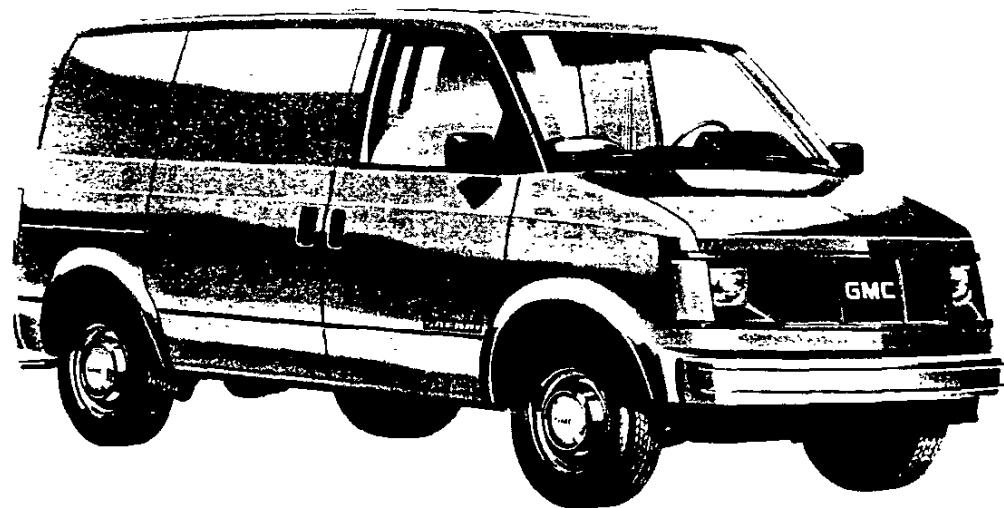

EXTERIOR

- **Bumpers:** Front and rear; painted lower body color
- **Colors:** See Interior and Exterior Color Selection Chart
- **Doors:** RH and LH front side doors; RH and LH rear load doors; and a RH sliding side load door
- **Door Opening and Locking Methods:**
 - Front side doors: Outside flush pull-out type door handle with separate key lock
 - Sliding side load door: Outside flush pull-out type handle releases both front and rear latches; for opening and closing of door from inside, reverse outside procedure
 - RH and LH rear doors: Flush pull-out type RH door handle opens door, and after opening RH door, LH door latch is released by inside handle; key lock cylinder in RH door
- **Glass:** Windshield; RH and LH front side door drop glass
- **Grille:** Molded plastic; painted black; integral Chevrolet emblem/GMC letters at center
- **Headlamps/Parking Lamps:** Headlamp/parking lamp bezels painted black
- **Horn:** Single, electric low-note
- **Hub Caps:** Bright metal with black trim
- **Keys:** Two-key system with separate keys for ignition switch and doors
- **Lights:**
 - Backup lamps: Two rear (integral with taillamps)
 - Combination parking/direction/hazard: Two front
 - Combination tail/stop/direction/hazard: Two rear
 - Headlamps: Two; Rectangular
 - License plate lamp: Single rear
 - Side marker lamps with reflectors: Integral with front parking lamps and rear taillamps
- **Mirrors:** RH and LH painted black; pivoting arm with adjustable 34.1 sq. in. head
- **Nameplates:** Bright "Astro/Safari" plate on front doors; bright "Chevrolet/GMC" letters on RH rear door in license plate housing
- **Tools:** Screw operated scissor-type jack with ratchet handle, extension and two wheel blocks
- **Undercoating:** Hot melt wax on entire underbody
- **Wheels:** Painted argent
- **Windshield Wipers and Washers:** Electric, 2-speed wipers with black finish on exposed metal portions; wet-arm design demand-type washer system

ASTRO/SAFARI

(Cargo Van)

STANDARD MODEL—BODY ORDERING CODE—ZW9

The standard model includes the following items as standard equipment

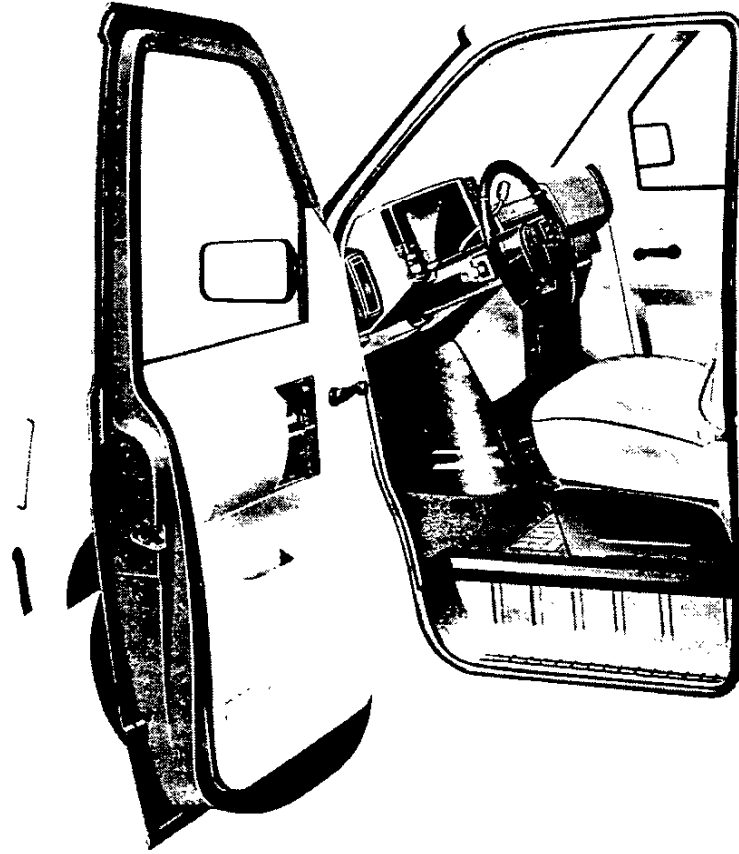

INTERIOR

- **Air Vents:** Integral with heater
- **Armrests:** LH and RH
- **Ashtray:** At center in engine cover console
- **Coat Hooks:** On LH roof rail to rear of driver's seat
- **Colors:**
Painted areas: Same as exterior primary color choice
Interior trim: Coordinated with seat trim color choice
- **Dome Lamps:** Two; with front door-actuated switches (dome lamps may also be activated by main light switch)
- **Door Locks:** Inside lock/release for front doors and sliding side door
- **Door Seals:** Latex foam rubber
- **Floor Covering:** Embossed black rubber mats on front floor area
- **Headliner:** Color-keyed molded styrofoam with foam and cloth cover; driver area
- **Heater and Defogger:** Deluxe-air
- **Hood Lock Release:** Handle located on RH side of instrument panel
- **Instruments:**
Gages: Speedometer, odometer, and fuel
Switches: Main, for control of exterior lights, instrument lights and dome lights; multi-function switch on steering column for direction signals by moving lever up or down (includes lane change position), headlight beams by pulling lever toward driver, windshield wiper by turning band marked "WIPER" toward or away from driver, and windshield washer by pushing in the lever knob; ignition with key-in warning buzzer; hazard warning; heater fan; door-operated dome lamp

Warning lights: Generator, oil pressure, engine temperature, service-parking brake, direction/hazard signal, and high beam

- **Instrument Panel:** Molded black plastic faceplate
- **Insulation and Sound Deadening Material:** Dash (firewall), front floor panel, engine cover front extension and inside engine cover
- **Lights:** Instruments, front and rear dome
- **Seat:** Front low back bucket driver; adjustable; all-vinyl trim; foam padded. Also available at extra cost: Low back or high back driver and passenger seats in standard vinyl, Custom vinyl or Custom Cloth. See Interior and Exterior Color Selection Chart for color and trim availability
- **Seat Belt:** Color-keyed with pushbutton release and outboard retractor
- **Spare Tire Carrier:** LH rear side
- **Steering Wheel and Column:** 15.24" diameter black vinyl wheel; black energy-absorbing steering column with anti-theft locking feature
- **Stowage Box:** In front face of engine cover extension; with latched door; includes beverage holder provisions
- **Sunshade:** LH, color-keyed
- **Trim Panels:** Injection molded plastic panels on front and sliding side doors; with storage pockets on front side doors

ASTRO/SAFARI (CARGO VAN) BODY CONSTRUCTION FEATURES

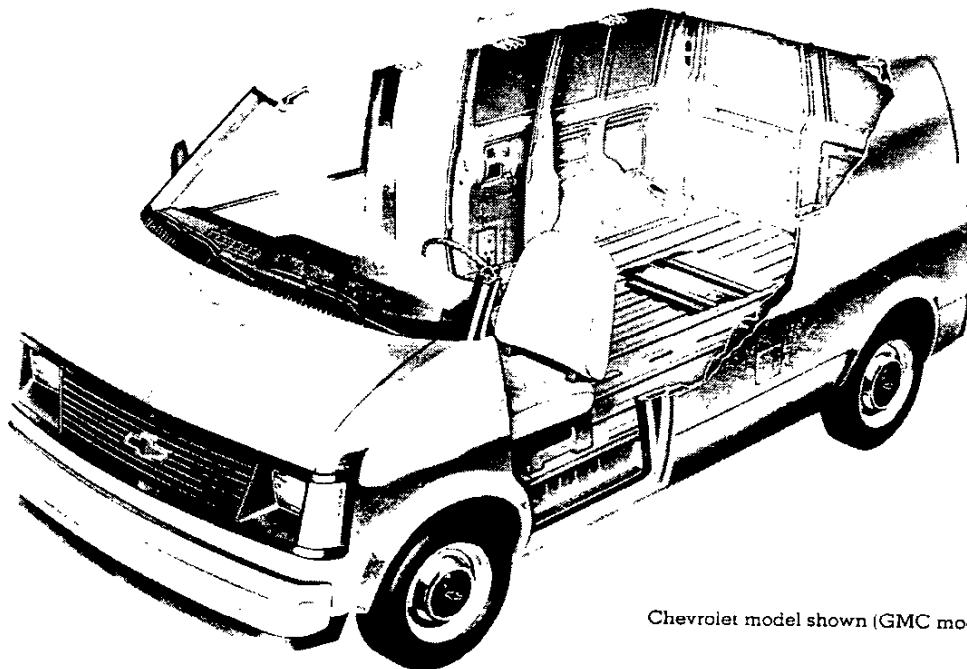

Chevrolet model shown (GMC model available)

BODY CONSTRUCTION FEATURES

- Computer-aided design.
- All-steel construction (except cowl panel).
- Body-frame integral construction for outstanding structural rigidity and excellent durability.
- Comprised of underbody structure, front end structure, left- and right-hand side panel structures and a roof panel structure.
- Longitudinal side rails, cross sills and outriggers form the integral frame to which front and rear floor panels are welded, completing the underbody structure. Main structural members are of heavy-gage steel. A step well is incorporated in the underbody in the area adjacent to the front doors and sliding side door to provide convenient entry and exit.
- Floor panel provides for available underfloor spare tire carrier.

FRONT END STRUCTURE

- Engine compartment with inside opening hood panel allows quick access to service points such as engine, radiator, brake system, battery and windshield washer reservoir.
- The radiator support upper tie bar is mechanically attached to facilitate engine removal.
- A plenum chamber with high-level air intake is utilized in the front end structure to assure a plentiful supply of dry, outside air for interior heating and ventilating as well as to add rigidity to the overall body structure. Air outlets to the interior are provided on the left-hand and right-hand sides by manually controlled doors (RH door omitted with optional air conditioning).
- Bolt-on front fenders for ease of serviceability.

SIDE PANEL STRUCTURES

- Seamless, one-piece outer panels reinforced with one-piece inner panel construction.
- Roof is welded to side panels.
- Inner side panels are welded to floor panel at bottom, leaving no exterior exposed welds.
- Many window configurations available.
- Front quarter and side door glass available on cargo model, standard on passenger van model.
- Optional rear quarter glass is fixed.
- All window openings are of one-piece stamped construction for excellent fit and corrosion resistance.
- Provision is made at the center of LH side panel for fuel filler door. Inside remote operation of door is available as an option.
- RH side panel incorporates center track for sliding door, providing low operating effort.
- Flush-mounted side glass.

ROOF PANELS

- One-piece design.
- Four longitudinal stiffening ribs.
- Welded to side panels.
- Eliminates exposed drip gutters.
- Center rear surface of panel is free of stiffening ribs to allow roof vent installation.
- Four roof bows support the roof panel.

ADDITIONAL BODY FEATURES

- Completely automated assembly features extensive use of automatic and robotic equipment to weld and assemble body.
- All body openings, front door frames, window frames, windshield frame, rear door frame and side door frame are of one-piece construction for precise fits and excellent corrosion resistance.
- Concealed front door hinges.
- Concealed hood hinges.
- Flush-mounted glass (except front doors).
- Improved body seals (weatherstrips) body mounted at front and side doors.
- On-line water test to eliminate leaks.

Special attention is given to corrosion prevention during the construction and final finishing of the body. The following body design features occur during the construction of the body:

- Use of special steel (galvanized, zinc iron alloy, zinc coated) for body components especially subject to corrosion.
- All exterior body panels (except roof) are two-side galvanized.
- Use of one-piece outer panels, eliminating exterior joints where corrosion might occur.
- Use of heavy-gage steel for main underbody components.
- One-piece opening frame construction eliminates lap joints and other potential corrosion areas.
- No exposed welds.

After body construction is completed, additional corrosion prevention steps are taken in the final finishing operation.

- The body, doors and hood are thoroughly cleaned through a 7-stage phosphate wash (4 immersion stages, 3 wash stages).
- Next, body, doors and hood are primed by the uni-prime process.
- Sealers are applied to all critical interior/exterior joints.
- The body, doors and hood are painted with base coat/clear coat enamel.
- An anti-chip coating along the lower body sides is added which extends from the rear of the front wheel openings to the rear door openings to prevent stone chipping.
- Hot-wax spray is applied to entire underbody for sound deadening and corrosion resistance.

ASTRO/SAFARI

(Cargo Van)

AVAILABLE WINDOW ARRANGEMENTS

(See Option Section For Restrictions)

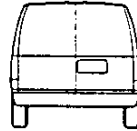
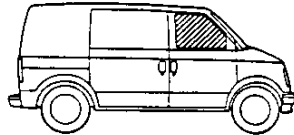
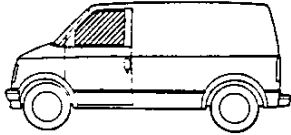

STANDARD

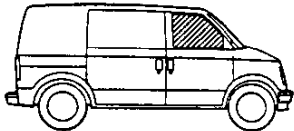
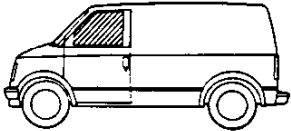

W/ZW2
Includes rear door windows.

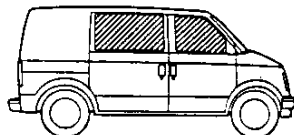
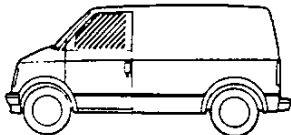

W/ZW3
Includes rear door windows and side cargo door window.

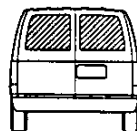
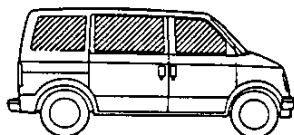
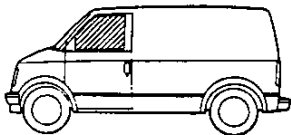

W/ZW4
Includes rear door windows, side cargo door window and RH rear quarter window.

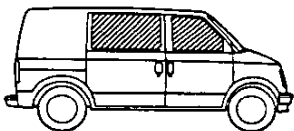
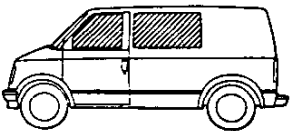

W/ZX4
Includes rear door windows, side cargo door window and LH front quarter window.

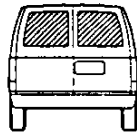
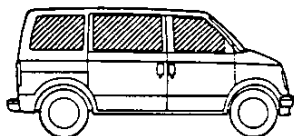
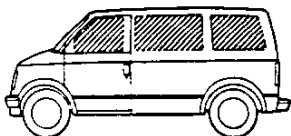

W/ZW6
Includes rear door windows, side cargo door window, RH rear quarter window and LH front and rear quarter windows.

AVAILABLE SEATING ARRANGEMENTS

(One Seating Arrangement Option Must Be Specified)
(See Interior and Exterior Chart For Restrictions)

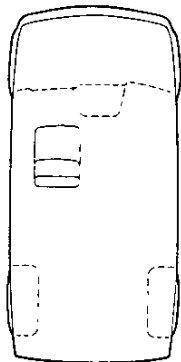

Standard
W/ZP1

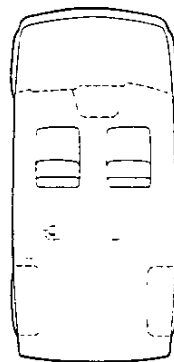

W/ZP2 or ZX2

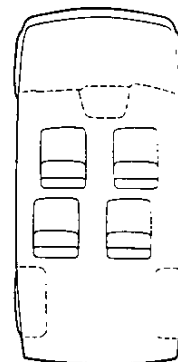

W/ZP4

ASTRO/SAFARI

(Cargo Van)

INTERIOR AND EXTERIOR COLOR AVAILABILITY CHART

Please Note: Below are the interior trim color and exterior paint combinations recommended by Chevrolet/GMC. The only available color code 1 color code 2 exterior color combinations are those shown in the chart below, however, any available interior trim color may be ordered with one of these exterior color combinations if that particular combination is desired by the customer.

INTERIOR COLORS		Teal Blue	Surround	Saddle Tan	State Gray	ZY1 PAINT OPTIONAL STRIPING CHART RECOMMENDED COMBINATIONS (Requires D85 Body Striping) Additional stripe combinations are available provided the dealer orders (DEO) as verification.				
STANDARD MODEL ASTRO/SAFARI										
Vinyl Seat (Reqs. ZP1 or ZP2)		VDD2		VSS2						
Vinyl High Back Bucket Seat (Reqs. ZX2)		VDD4		VSS4						
Custom Vinyl High Back Bucket Seat (Reqs. ZP4 or ZX2)		VDD4	VEE4	XSS4	XTT4					
Custom Cloth High Back Bucket Seat (Reqs. ZP4 or ZX2)		VDD4	KEE4	KSS4	KTT4					
EXTERIOR COLORS w/ZY1 PAINT	Color Code 1	Color Code 2	RECOMMENDED INTERIOR TRIM COLORS			Blue/Silver 25A	Gold/Brown 54A	Red/Black 74A	Red/Silver 71A	Yellow/White 53A
BLACK, SABLE (Metallic)	18	18		X				X		
BLACK, SABLE (Metallic)	18	18	X			X				
BLACK, SABLE (Metallic)	18	18			X					
BLUE, CARIBBEAN (Metallic)	26	26	X			X				
BLUE, TEAL (Metallic)	25	25	X			X				
BROWN, DARK (Metallic)	69	69		X			X			
GOLD, CALIFORNIA (Metallic)	52	52		X			X			
GRAY (Metallic)	83	83		X				X		
GRAY (Metallic)	83	83			X				X	
RED, DEEP (Metallic)	75	75	X		X			X		
SILVER, STERLING (Metallic)	15	15		X	X					
SILVER, STERLING (Metallic)	15	15	X			X				
SILVER, STERLING (Metallic)	15	15		X					X	
TAN	60	60		X			X			
WHITE, SUMMIT	50	50		X		X				
WHITE, SUMMIT	50	50	X				X			
WHITE, SUMMIT	50	50		X	X					
w/ZY3 or ZY7 PAINT	*STRIPE COLORS (Stripe Colors cannot be changed)									
BLACK SABLE (Met.)/Silver, Sterling (Met.)	18	15		X				X		
BLUE, CARIBBEAN (Met.)/Blue, Teal (Met.)	26	25	X			X				
BLUE, TEAL (Met.)/Silver, Sterling (Met.)	25	15	X			X				
BROWN, DARK (Met.)/Silver, Sterling (Met.)	69	15		X				X		
BROWN, DARK (Met.)/Gold, California (Met.)	69	52		X			X			
GRAY (Met.)/Silver, Sterling (Met.)	83	15		X	X			X		
RED, DEEP (Met.)/Silver, Sterling (Met.)	75	15	X		X			X		
SILVER, STERLING (Met.)/Gray (Met.)	15	83	X		X			X		
TAN/Gold, California (Met.)	60	52		X					X	
WHITE, SUMMIT/Blue, Teal (Met.)	50	25	X			X				
WHITE, SUMMIT/Gold, California (Met.)	50	52		X			X			
WHITE, SUMMIT/Gray (Met.)	50	83		X	X			X		

*D85 required if stripe is desired w/ZY7 Paint. Stripe is included w/ZY3 Paint

ASTRO/SAFARI

(Cargo Van)

SOLID AND TWO-TONE* EXTERIOR COLOR COMBINATIONS

The application of paint for solid and two-tone exterior color combinations is shown below.

SOLID COLOR

Solid paint (ZY1) is standard on all models. All painted areas of the body and front end sheet metal, including the bumpers, are the same color.



Chevrolet model shown (GMC model available)

SPECIAL TWO-TONE

Special two-tone paint (ZY3), is available on all models and includes a dual color decal stripe located at the belt styling crease line. The areas above the decal are painted color code 1. The areas below the decal, including the bumpers, are painted color code 2.



Chevrolet model shown (GMC model available)

SPORT TWO-TONE

Sport two-tone paint (ZY7), which provides a lower accent two-tone scheme, is available on all models. Color code 1 is applied to the areas above the lower styling crease line and color code 2 is applied to the areas below, including the bumpers and fender flares.

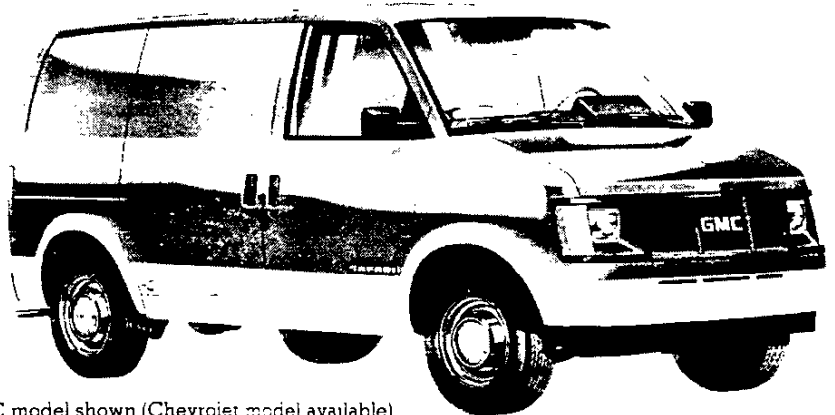

GMC model shown (Chevrolet model available)

*Optional at extra cost

NOTES