



MANUFACTURERS MOTOR VEHICLE SPECIFICATIONS

METRIC(U.S. Customary)

Passenger Car

1987

Manufacturer Chevrolet Motor Division
General Motors Corporation

Car Line

Celebrity

Issued June, 1986

Revised
SEPTEMBER, 1986

Questions concerning these specifications should be directed to the manufacturer whose address is shown above.

The information contained herein is prepared, distributed by, and is solely the responsibility of the automobile manufacturing company to whose products it relates. This specification form was developed by the automobile manufacturing companies under the auspices of the Motor Vehicle Manufacturers Association of the United States, Inc.

The General Specifications herein are those in effect at date of compilation and are subject to change without notice by the manufacturer.

Blank Forms Provided by Technical Affairs Division



Motor Vehicle Manufacturers Association
of the United States, Inc.



MVMA Specifications Form Passenger Car

Car Line CELEBRITY
 Model Year 1987 Issued 6-86 Revised (e) 9-86

METRIC (U.S. Customary)

Engine Description/Carb.
 Engine Code

2.5 Liter L-4 (151 CID)
 Electronic Fuel Inj.
 RPO LR8

ENGINE - GENERAL

Type & description (inline, V, angle, flat, location, front, mid, rear, transverse, longitudinal, sohc, dohc, ohv, hemi, wedge, pre-camber, etc.)	In-line Front 60° V-6 Transverse, front of engine faces right side of vehicle	
Manufacturer	Pontiac	
No. of cylinders	4	
Bore	101.6 (4.0)	
Stroke	76.2 (3.0)	
Bore spacing (C/L to C/L)	111.8 (4.40)	
Cylinder block material & mass kg (lbs.) (machined)	Cast Alloy Iron 42.554 (93.8)	
Cylinder block deck height	236.1 (9.3)	
Cylinder block length		
Deck clearance (minimum) (above or below block)	.64 (.025)-Below	
Cylinder head material & mass kg (lbs.)	Cast Alloy Iron 18.500 (40.8)	
Cylinder head volume (cm ³)	45.62 (2.78)	
Cylinder liner material		
Head gasket thickness (compressed)	0.97 (.038)	
Minimum combustion chamber total volume (cm ³)	70.82 (4.32)	
Cyl. no. system (front to rear)**	L. Bank	1-2-3-4
	R. Bank	--
Firing order	1-3-4-2	
Intake manifold material & mass (kg (lbs.))**	Aluminum Cast 3.500 (7.7)	
Exhaust manifold material & mass (kg (lbs.))**	Stainless Steel 1.980 (4.4)	
Recommended fuel (leaded, unleaded, diesel)	Unleaded	
Fuel antiknock index (R + M) 2	87	
Total dressed engine mass (wt) dry***	158.2 (348.8) Auto.	

Engine - Pistons

Material & mass, g (weight, oz.) - piston only	Cast Aluminum Alloy .600 (1.3)
--	--------------------------------

Engine - Camshaft

Location	Right side of block	
Material & mass kg (weight, lbs.)	Cast Iron 3.484 (7.7)	
Drive type	Chain / belt	Gear
	Width / pitch	--

* Rear of engine - drive takeoff. View from drive takeoff end to determine left & right side of engine.

** Finished state.

*** Dressed engine mass (weight) includes the following:

All those items necessary to make the engine a complete ready to run unit.

MVMA Specifications Form Passenger Car

Car Line CELEBRITY
 Model Year 1987 Issued 6-86 Revised (*) 9-86

METRIC (U.S. Customary)

Engine Description/Carb.
 Engine Code

2.8 Liter - V6 H.O.
 (2.8 Multi-Port FI)
 RPO LB6

ENGINE - GENERAL

Type & description (inline, V, angle, flat, location, front, mid, rear, transverse, longitudinal, sohc, dohc, ohv, hemi, wedge, pre-camber, etc.)		60° V Transverse, front of engine faces right side of vehicle
Manufacturer		Chevrolet
No. of cylinders		6
Bore		89 (3.50)
Stroke		76 (2.99)
Bore spacing (C/L to C/L)		111.8 (4.40)
Cylinder block material & mass kg (lbs.) (machined)		Cast Alloy Iron 41.731 (91.9)
Cylinder block deck height		224 (8.819)
Cylinder block length		
Deck clearance (minimum) (above or below block)		0.12 (.005) Below
Cylinder head material & mass kg (lbs.)		Cast Alloy Aluminum 5.300 (11.7)
Cylinder head volume (cm ³)		--
Cylinder liner material		
Head gasket thickness (compressed)		0.838 (0.033)
Minimum combustion chamber total volume (cm ³)		59.8481 (3.6515)@
Cyl. no system (front to rear)*	L. Bank	2-4-6
	R. Bank	1-3-5
Firing order		1-2-3-4-5-6
Intake manifold material & mass (kg (lbs.))**		Cast Aluminum 3.810 (8.4)
Exhaust manifold material & mass (kg (lbs.))**		Cast Iron LH 2.630 (5.8), RH 3.670 (8.1)
Recommended fuel (leaded, unleaded, diesel)		Unleaded
Fuel antiknock index (R + M) 2		87
Total dressed engine mass (wt) dry***		193.8 (427.3) Man. 181.5 (400.1) Auto.

Engine - Pistons

Material & mass, g (weight, oz.) - piston only	Cast Aluminum Alloy, .474 (1.04), Flat Head
--	---

Engine - Camshaft

Location	In block above crankshaft
Material & mass kg (weight, lbs.)	Cast iron, 3.098 (6.83)
Drive type	Chain / belt
	Width / pitch

* Rear of engine - drive takeoff. View from drive takeoff end to determine left & right side of engine.

** Finished state

*** Dressed engine mass (weight) includes the following:

@ - Piston at TDC, spark plug and valves in place, and cylinder head torqued to specifications.

MVMA Specifications Form Passenger Car

Car Line CELEBRITY
 Model Year 1987 Issued 6-86 Revised (•) 9-86

METRIC (U.S. Customary)

Engine Description/Carb.
Engine Code

2.5 Liter L4 (151 CID)
 Electronic Fuel Injection
 RPO LR8

Engine - Valve System

Hydraulic lifters (std., opt., NA)	Standard
Valves	Number intake / exhaust
	Head O.D. intake / exhaust

4/4
43.69 (1.72)/38.10 (1.50)

Engine - Connecting Rods

Material & mass [kg., (weight, lbs.)]*	Cast Mall. Iron .550 (1.213)
--	------------------------------

Engine - Crankshaft

Material & mass [kg., (weight, lbs.)]*	Nodular cast iron/12.519(27.59)
End thrust taken by bearing (no.)	5
Number of main bearings	5
Seal (material, one, two piece design, etc.)	Front
	Rear

Engine - Lubrication System

Normal oil pressure (kPa (psi) at engine rpm)	2.59 (37.5)
Type oil intake (floating, stationary)	Stationary
Oil filter system (full flow, part, other)	Full flow
Capacity of c/case, less filter-refill-L (qt.)	2.8 (3.0)

Engine - Diesel Information

Diesel engine manufacturer	
Glow plug, current drain at 0°F	Not
Injector nozzle	Type
	Opening pressure [kPa (psi)]
Pre-chamber design	Applicable
Fuel injection pump	Manufacturer
	Type
Fuel injection pump drive (belt, chain, gear)	
Supplementary vacuum source (type)	
Fuel heater (yes/no)	
Water separator, description (std., opt.)	
Turbo manufacturer	
Oil cooler-type (oil to engine coolant; oil to ambient air)	
Oil filter	

Engine - Intake System

Turbo charger - manufacturer	Not Applicable
Super charger - manufacturer	
Charge cooler	

*Finished State

MVMA Specifications Form Passenger Car

METRIC (U.S. Customary)

Car Line CELEBRITY
 Model Year 1987 Issued 6-86 Revised (*) 9-86

Engine Description/Carb.
 Engine Code

2.8 Liter V6 (173 CID)
 Multi-Port Fuel Injection
 RPO LB6

Engine - Valve System

Hydraulic lifters (std., opt., NA)	Standard
Valves	Number intake / exhaust
	Head O.D. intake / exhaust

6/6
 43.64 (1.72)/36.20 (1.43)

Engine - Connecting Rods

Material & mass (kg., (weight, lbs.))*	1038 steel/.399 (0.879)
--	-------------------------

Engine - Crankshaft

Material & mass (kg., (weight, lbs.))*	Nodular cast iron/17.125(37.75)
End thrust taken by bearing (no.)	3
Number of main bearings	4
Seal (material, one, two piece design, etc.)	Front
	Rear

Engine - Lubrication System

Normal oil pressure (kPa (ps.) at engine rpm)	345-450 (50-65) @ 1200
Type oil intake (floating, stationary)	Stationary
Oil filter system (full flow, part, other)	Full flow
Capacity of c/case, less filter-refill-L (qt.)	3.8 (4.0)

Engine - Diesel Information

Diesel engine manufacturer	
Glow plug, current drain at 0°F	Not
Injector nozzle	Type
	Opening pressure [kPa (psi)]
Pre-chamber design	Applicable
Fuel injection pump	Manufacturer
	Type
Fuel injection pump drive (belt, chain, gear)	
Supplementary vacuum source (type)	
Fuel heater (yes/no)	
Water separator, description (std., opt.)	
Turbo manufacturer	
Oil cooler-type (oil to engine coolant; oil to ambient air)	
Oil filter	

Engine - Intake System

Turbo charger - manufacturer	Not Applicable
Super charger - manufacturer	
Charge cooler	

*Finished State

**MVMA Specifications Form
Passenger Car**

Car Line CELEBRITY
 Model Year 1987 Issued 6-86 Revised (e) _____

METRIC (U.S. Customary)

Car Models

Model Description & Drive (FWD/RWD)	Introduction Date	Make, Car Line, Series, Body Type (Mfr's Model Code)	No. of Designated Seating Positions (Front/Rear)			Max. Trunk Cargo Load—Kilograms (Pounds)
<u>FRONT WHEEL DRIVE</u>						
CELEBRITY		MODEL NUMBER	FRONT/REAR - 3RD			
2-Door Notchback Coupe		1AW27	3	3		72.5 (159.8)
4-Door Notchback Sedan		1AW19	3	3		72.5 (159.8)
4-Door Station Wagon		1AW35	3	3		136.2 (300)
4-Door Station Wagon with RPO A04-3rd seat		1AW35 with A04	3	3	2	0

Note: Any specifications on the following pages that are specific to California requirements are indicated accordingly.

MVMA Specifications Form Passenger Car

Car Line CELEBRITY
 Model Year 1987 Issued 6-86 Revised (*) 9-86

METRIC (U.S. Customary)

Power Teams (Indicate whether standard or optional)
 SAE J1349 Net bhp (brake horsepower) and net torque corrected to 77°F/25° C and 29.61 In. Hg/100 kPa atmospheric pressure.

SERIES AVAILABILITY	ENGINE					E x h a u s t r i a n S D	TRANSMISSION/ TRANSAXLE	DRIVE RATIOS (:1)			
	Displ. Liters (in ³)	Carb. (Barrels, FI, etc.)	Compr. Ratio	SAE Net at RPM				AXLE RATIO @			
				Power kW (bhp)	Torque N·m (lb. ft.)			Overall Veh.	Overal Veh.	Base	Drive Opt.
Base - All States	L4 2.5L (151 CID) LP8	EFI *	8.3:1	(98 @ 4800)	(135 @ 3200)	S	Auto '125c' (MD9)-Opt.	2.84*§	2.84	--	--
Opt. - All States	V6 2.8L (173 CID) LB6	MFI **	8.9:1	(125 @ 4500)	(160 @ 3600)	S	Man. 5-Spd. 3.50 Low (MG2)-Base§	3.61	2.60	--	--
							Auto '125c' (MD9)-Opt.	2.84§	2.84	3.18+§	3.18
							Auto '440-T4' (ME9)-Opt.	3.33§	2.33	--	--
@ - Not available in California % - Not available on Eurosport Wagon \$ - Axle ratio = chain drive x differential drive ratio # - Optional on Sedans and Coupes; base on wagon + - Optional ratio - base ratio with Chev. Eurosport * - Base for Sedans and Coupes only ** - Multi-Port Fuel Injection *** - Fuel Injection Diesel § - Available on Eurosport only											

MVMA Specifications Form Passenger Car

Car Line CELEBRITY
 Model Year 1987 Issued 6-86 Revised (●) _____

METRIC (U.S. Customary)

Engine Description/Carb.
 Engine Code

2.5 Liter L4 (151 CID)
 Electronic Fuel Injection
 RPO LR8

Engine - Cooling System

Coolant recovery system (std., opt., n.a.)		Standard		
Coolant fill location (rad., bottle)		Bottle, coolant recovery		
Radiator cap relief valve pressure [kPa (psi)]		103.4 (15.0)		
Circulation thermostat	Type (choke, bypass)	Choke		
	Starts to open at °C (°F)	90 (195°)		
Water pump	Type (centrifugal, other)	Centrifugal		
	GPM 1000 pump rpm	--		
	Number of pumps	One		
	Drive (V-belt, other)	V-belt		
	Bearing type	Sealed double row ball		
	Impeller material			
Housing material				
By-pass recirculation (type (inter., ext.))		Internal		
Cooling system capacity	With heater-L (qt.)	9.24(9.8)Auto, 9.34(9.9)Man		
	With air cond-L (qt.)	9.48(10.0)Auto, 9.58(10.1)Man		
	Opt. equipment (specify-L (qt.))	9.30(9.8)Auto, 9.40(9.9) Man		
Water jackets full length of cyl. (yes. no)		Yes		
Water all around cylinder (yes. no)		Yes		
Water jackets open at head face (yes. no)				
Radiator core	Std., A/C, HD	STD.	A/C	H.D.
	Type (cross-flow, etc.)	Cross-flow		
	Construction (fin & tube mechanical, braze, etc.)			
	Material, mass [kg (wt. lbs.)]	Copper-brass, high efficiency radiator		
	Width	430.0	668.0	668.0
	Height	429.7	429.7	429.7
	Thickness	25.0	40.2	40.2
	Fins per inch @	3.5	4.0	4.0
Radiator end tank material		Copper		
Std., elec., opt		Standard/Optional		
Number of blades & type (flex, solid, material)		Standard 4-blade, A/C 7-blade, A/C & HD 5-blade (Plastic)		
Diameter & projected width		Std. 291.0 (11.5), A/C 352.5 (13.9), A/C & HD 390.5 (15.4)		
Ratio (fan to crankshaft rev.)		--		
Fan	Fan cutout type		ECM Controlled	
	Drive type (direct, remote)		Electric, standard/optional (a)	
	RPM at idle (elec.)		1900 (2700 with A/C and heavy duty cooling)	
	Motor rating (wattage) (elec.)		97 (150 with A/C and heavy duty cooling)	
	Motor switch (type & location) (elec.)		Engine temperature switch, engine cylinder head	
	Switch point (temp., pressure) (elec.)		110°C	
	Fan shroud (material)		None	

@ - Distance between top of fins.

(a) - With rotating reinforcement ring, shrouded.

MVMA Specifications Form
Passenger Car
METRIC (U.S. Customary)

Car Line CELEBRITY
 Model Year 1987 Issued 6-86 Revised (*) _____

Engine Description/Carb.
 Engine Code

2.8 Liter V6 (173 CID)
 (2.8 Multi-Port FI)
 RPO LB6

Engine - Cooling System

Coolant recovery system (std., opt., n.e.)	Standard			
Coolant fill location (rad., bottle)	Bottle, coolant recovery			
Radiator cap relief valve pressure (kPa (psi))	103.4 (15.0)			
Circulation thermostat	Type (choke, bypass)	Choke		
	Starts to open at °C (°F)	90 (195°)		
Water pump	Type (centrifugal, other)	Centrifugal		
	GPM 1000 pump rpm	22.7 @ 3000 pump RPM		
	Number of pumps	One		
	Drive (V-belt, other)	V-Belt		
	Bearing type	Ball-Roller		
	Impeller material			
Housing material				
By-pass recirculation [type (inter., ext.)]	Internal			
Cooling system capacity	With heater—L (qt.)	11.82 (12.5) Auto		
	With air cond.—L (qt.)	11.96 (12.6) Auto		
	Opt. equipment [specify—L (qt.)]	12.16 (12.8) Auto		
Water jackets full length of cyl. (yes, no)	Yes			
Water all around cylinder (yes, no)	Yes			
Water jackets open at head face (yes, no)				
Radiator core	Std., A/C, HD	Std.	A/C or V08	A/C and V08
	Type (cross-flow, etc.)	Cross flow		
	Construction (fin & tube mechanical, braze, etc.)			
	Material, mass [kg (wgt. lbs.)]	Copper/brass high efficiency radiator		
	Width	668.0	668.0	667.5
	Height	429.7	429.7	437.8
	Thickness	25.0	40.2	34.0
	Fins per inch #	4.0	3.0	2.5
Radiator end tank material	Copper			
Fan	Std., elec., opt.	Standard, Electric		
	Number of blades & type (flex, solid, material)	Standard 7-blades/A/C 7-blades, A/C & HD 5-blade (Plastic)		
	Diameter & projected width	Standard 352.5 (13.9)/A/C 352.5(13.9) A/C & HD 390.5 (15.4)		
	Ratio (fan to crankshaft rev.)	--		
	Fan cutout type	-- *		
	Drive type (direct, remote)	Electric, standard/optional (a)		
	RPM at idle (elec.)	1800		
	Motor rating (wattage) (elec.)	150-W		
	Motor switch (type & location) (elec.)	Engine temperature switch, engine cylinder head		
	Switch point (temp., pressure) (elec.)	110°C		
	Fan shroud (material)	None		

- Distance between top of fins.
 * - Fan is in continuous operation when A/C is on.
 (a)- With rotating reinforcement ring, shrouded.

MVMA Specifications Form Passenger Car

Car Line CELEBRITY
 Model Year 1987 Issued 6-86 Revised (●) 9-86

METRIC (U.S. Customary)

Engine Description/Carb.
 Engine Code

2.5 Ltr L4 (151 CID)
 Electronic Fuel Inj.
 RPO LR8

Engine - Fuel System (See supplemental page for details of Fuel Injection, Supercharger, Turbocharger, etc. if used)

Induction type: carburetor, fuel injection system, etc.		Fuel Injection	
Manufacturer		None	
Carburetor	Choke (type)	"	
	Idle spd.-rpm (spec. neutral or drive and propane if used)	Manual	"
		Automatic	"
Idle A/F mix.		Preset - no adjustment provided	
Fuel injection	Point of injection (no.)	Throttle Body	
	Constant, pulse, flow	Pulse	
	Control (electronic, mech.)	Electronic	
	System pressure [kPa (psi)]	83.0 (12.0)	
Intake manifold heat control (exhaust or water thermostatic or fixed)		Water	
Air cleaner type	Standard	(*)	
	Optional	--	
Fuel pump	Type (elec. or mech.)	Electrical	
	Location (eng., tank)	Fuel Tank	
	Pressure range [kPa (psi)]	83.0 (12.0)	

Fuel Tank

Capacity (refill L (gallons))		59.4 (15.7) approx.
Location (describe)		Underside - rear center
Attachment		Underbody strap
Material & Mass (kg (weight lbs))		Steel 9.487 (20.9)
Filler pipe	Location & material	Driver side rear quarter
	Connection to tank	Solder
Fuel line (material)		Steel
Fuel hose (material)		Rubber
Return line (material)		Steel
Vapor line (material)		Steel
Extended range tank	Opt. n.a.	Not available
	Capacity [L (gallons)]	"
	Location & material	"
	Attachment	"
Auxiliary tank	Opt. n.a.	"
	Capacity [L (gallons)]	"
	Location & material	"
	Attachment	"
	Selector switch or valve	"
	Separate fill	"

(*) - Replaceable paper element, single snorkel.
 (+) - Oil wetted paper element.

MVMA Specifications Form Passenger Car

Car Line CELEBRITY
 Model Year 1987 Issued 6-86 Revised (●) 9-86

METRIC (U.S. Customary)

Engine Description/Carb.
 Engine Code

2.8 Liter - V6
 Multi-Port Fuel Injection
 RPO LB6

Engine - Fuel System (See supplemental page for details of Fuel Injection, Supercharger, Turbocharger, etc. if used)

Induction type: carburetor, fuel injection system, etc.		Fuel Injection	
Manufacturer		Not Available	
Carburetor	Choke (type)	None	
	Idle spd.-rpm (spec. neutral or drive and propane if used)	Manual	"
		Automatic	"
Idle A:F mix.		Preset - no adjustment provided	
Fuel injection	Point of injection (no.)	Fuel Injectors at inlet ports	
	Constant, pulse, flow	Pulse	
	Control (electronic, mech.)	Electronic	
	System pressure [kPa (psi)]	--	
Intake manifold heat control (exhaust or water thermostatic or fixed)			
Air cleaner type	Standard	(*)	
	Optional	Not Available	
Fuel pump	Type (elec. or mech.)	Electrical	
	Location (eng. tank)	Fuel Tank	
	Pressure range [kPa (psi)]	160.0-250.0 (24.0-37.0)	

Fuel Tank

Capacity [retill L (gallons)]		59.4 (15.7) approx.
Location (describe)		Underside - rear center
Attachment		Underbody strap
Material & Mass [kg (weight lbs)]		Steel #1008 or 1010 GM-124-M 9.487 (20.9)
Filler pipe	Location & material	Driver side rear quarter
	Connection to tank	Solder
Fuel line (material)		Steel #1008 or 1010 GM-124-M
Fuel hose (material)		Rubber
Return line (material)		Steel #1008 or 1010 GM-124-M
Vapor line (material)		Steel #1008 or 1010 GM-124-M
Extended range tank	Opt., n.a.	Not Available
	Capacity [L (gallons)]	"
	Location & material	"
	Attachment	"
Auxiliary tank	Opt., n.a.	"
	Capacity [L (gallons)]	"
	Location & material	"
	Attachment	"
	Selector switch or valve	"
Separate fill		"

(*) - Replaceable paper element, single snorkel.

MVMA Specifications Form Passenger Car

Car Line CELEBRITY
 Model Year 1987 Issued 6-86 Revised (●) 9-86

METRIC (U.S. Customary)

Engine Description/Carb.
 Engine Code

2.5L L-4 (151 CID)
 Elect. Fuel Inj
 RPO LR8

Vehicle Emission Control

Exhaust Emission Control	Type (air injection, engine modifications, other)		CCC control
	Air Injection	Pump or pulse	None
		Driven by	None
		Air distribution (head, manifold, etc.)	None
		Point of entry	None
	Exhaust Gas Recirculation	Type (controlled flow, open orifice, other)	Controlled Flow
		Exhaust source	Manifold
		Point of exhaust injection (spacer, carburetor, manifold, other)	Inlet manifold
	Catalytic Converter	Type	Oxid-Red, Sng bed
		Number of	One
		Location(s)	Mounted to Underbody
		Volume [L (in ³)]	2.6 (160)
Substrate type		Pellets	
Crankcase Emission Control	Type (ventilates to atmosphere, induction system, other)		Induction system
	Energy source (manifold vacuum, carburetor, other)		Manifold vacuum
	Discharges (to intake manifold, other)		Inlet manifold
	Air inlet (breather cap, other)		Air cleaner
Evaporative Emission Control	Vapor vented to (crankcase, canister, other)	Fuel tank	Canister
		Carburetor	--
	Vapor storage provision		Canister
Electronic system	Closed loop (yes no)		Yes
	Open loop (yes no)		No

Engine - Exhaust System

Type (single, single with cross-over, dual, other)		Single
* Muffler no. & type (reverse flow, straight thru, separate resonator)	Material & Mass (kg (weight lbs))	One-reverse flow
Resonator no. & type		None
➤ Exhaust pipe	Branch o.d., wall thickness	--
	Main o.d., wall thickness	50.8x1.12(2.0x.044)
	Material & Mass (kg (weight lbs))	Stainless steel
* Intermediate pipe	o.d. & wall thickness	50.8x1.12(2.0x.044)
	Material & Mass (kg (weight lbs))	Alumn.coated steel
* Tail pipe	o.d. & wall thickness	50.8x1.4(2.0x.055)
	Material & Mass (kg (weight lbs))	Alumn.coated steel

* Purchased as unit: 11.200 (24.7)

MVMA Specifications Form Passenger Car

Car Line CELEBRITY
 Model Year 1987 Issued 6-86 Revised (*) 9-86

METRIC (U.S. Customary)

Engine Description/Carb.
Engine Code

2.8 LITER-V6 (173 CID)
 2.8 MULTI-PORT FI
 RPO - LB6

Vehicle Emission Control

Exhaust Emission Control	Type (air injection, engine modifications, other)		CCC Control
	Air Injection	Pump or pulse	None
		Driven by	None
		Air distribution (head, manifold, etc.)	None
		Point of entry	None
	Exhaust Gas Recirculation	Type (controlled flow, open orifice, other)	Not available
		Exhaust source	Not available
		Point of exhaust injection (spacer, carburetor, manifold, other)	Not available
	Catalytic Converter	Type	Single bed, oxidizing & reducing
		Number of	One
Location(s)		Mounted to underbody	
Volume [L (in ³)]		2.78 (170)	
Substrate type		Monolith	
Crankcase Emission Control	Type (ventilates to atmosphere, induction system, other)		Induction system
	Energy source (manifold vacuum, carburetor, other)		Manifold vacuum
	Discharges (to intake manifold, other)		Intake manifold
	Air inlet (breather cap, other)		Air cleaner
Evaporative Emission Control	Vapor vented to (crankcase, canister, other)	Fuel tank	Canister
		Carburetor	--
	Vapor storage provision		Canister
Electronic system	Closed loop (yes/no)		Yes
	Open loop (yes/no)		No

Engine - Exhaust System

Type (single, single with cross-over, dual, other)		Single with cross-over	
*	Muffler no. & type (reverse flow, straight thru, separate resonator) Material & Mass (kg (weight lbs))	One reverse flow	
	Resonator no. & type	None	
*	Exhaust pipe	Branch o.d., wall thickness	--
		Main o.d., wall thickness	50.8 X 0.81 (2.0 X 0.03)
		Material & Mass (kg (weight lbs))	Laminated tubing-stainless steel outer, steel inner
*	Inter-mediate pipe	o.d. & wall thickness	57.15 X 0.81 (2.25 X 0.03)
		Material & Mass (kg (weight lbs))	Aluminum coated steel
*	Tail pipe	o.d. & wall thickness	57.15 X 1.10 (2.25 X 0.04)
		Material & Mass (kg (weight lbs))	Aluminum coated steel (a)

(a) Dual tail pipes on Eurosport Sedan and Coupes
 (Single pipe on wagon).

* Purchased as unit: 10.319 (22.7)

MVMA Specifications Form Passenger Car

Car Line CELEBRITY
 Model Year 1987 Issued 6-86 Revised (●) 9-86

METRIC (U.S. Customary)

Engine Description/Carb.
 Engine Code

2.5L L-4 (151 CID)
 Electronic Fuel Inj.
 RPO LR8

Transmissions/Transaxle

Manual 3-speed (std., opt., n.a.) (mfr.)	Not Available
Manual 4-speed (std., opt., n.a.) (mfr.)	Not Available
Manual 5-speed (std., opt., n.a.) (mfr.)	Not Available
Manual overdrive (std., opt., n.a.) (mfr.)	Not Available
Automatic (std., opt., n.a.) (mfr.)	Standard
Automatic overdrive (std., opt., n.a.) (mfr.)	Not Available

Manual Transmission/Transaxle

Number of forward speeds			
Transmission ratios	In first		
	In second	Not	
	In third	Applicable	
	In fourth		
	In fifth		
	In overdrive		
	In reverse		
Synchronous meshing (specify gears)			
Shift lever location			
Lubricant	Capacity [L (pt.)]		
	Type recommended		
	SAE viscosity number	Summer	
		Winter	
Extreme cold			

Clutch (Manual Transmission)

Make, type, engagement (describe) - (hydraulic, cable, rod)		
Assist (yes, no, percent)		Not
Type pressure plate springs		Applicable
Total spring load [N (lb.)]		
No. of clutch driven discs		
Clutch facing	Material	
	Manufacturer	
	Part number	
	Rivets plate	
	Rivet size	
	Outside & inside dia.	
	Total eff. area [cm ² (in. ²)]	
	Thickness	
Engagement cushion method		
Release bearing	Type & method of lubrication	
Torsional damping	Method: springs, friction material	

MVMA Specifications Form Passenger Car

Car Line CELEBRITY
 Model Year 1987 Issued 6-86 Revised (●) 9-86

METRIC (U.S. Customary)

Engine Description/Carb.
 Engine Code

2.8 Liter - V6
 Multi-Port Fuel Injection
 RPO LB6

Transmissions/Transaxle

Manual 3-speed (std., opt., n.a.) (mfr.)	Not Available
Manual 4-speed (std., opt., n.a.) (mfr.)	Not Available
Manual 5-speed (std., opt., n.a.) (mfr.)	Standard
Manual overdrive (std., opt., n.a.) (mfr.)	Not Available
Automatic (std., opt., n.a.) (mfr.)	Optional
Automatic overdrive (std., opt., n.a.) (mfr.)	Optional

Manual Transmission/Transaxle

Number of forward speeds		5	
Transmission ratios	In first	3.50	
	In second	2.05	
	In third	1.38	
	In fourth	0.94	
	In fifth	0.72	
	In overdrive		
	In reverse	3.41	
Synchronous meshing (specify gears)		All forward gears	
Shift lever location		Floor	
Lubricant	Capacity [L (pt.)]	2.55L (5.36 pts.)	
	Type recommended	SAE 5W-30 engine oil SF, SF/CC or SF/CD	
	SAE viscosity number:	Summer	"
		Winter	"
		Extreme cold	"

Clutch (Manual Transmission)

Make, type, engagement (describe - hydraulic, cable, rod)		Belleville, spring cover and pressure plate assy. Single dry disc, hydraulic linkage, automatic adjuster.
Assist (yes no percent)		No
Type pressure plate springs		Diaphragm
Total spring load [N (lb.)]		5700 (1281)
No. of clutch driven discs		One
Clutch facing	Material	Non asbestos
	Manufacturer	Valeo
	Part number	F202
	Rivets plate	16
	Rivet size	5.41 x 3.63 (0.213 x 0.143)
	Outside & inside dia	232.0 x 155.0 (9.125 x 6.125)
	Total eff. area [cm ² (in ²)]	232.0 (35.96)
	Thickness	7.6 (0.300)
Engagement cushion method		Driven plate wave spoke springs
Release bearing	Type & method of lubrication	Self centering angular contact ball bearing pre-packed and sealed.
Torsional damping	Method: springs friction material	Coil springs with non-metal friction control.

MVMA Specifications Form Passenger Car

Car Line CELEBRITY
 Model Year 1987 Issued 6-86 Revised (*) 9-86

METRIC (U.S. Customary)

Engine Description/Carb.
Engine Code

2.5L L4 (151 CID)
Electronic Fuel Inj.
RPO LR8

Automatic Transmission/Transaxle

Trade name		3-speed automatic
Type and special features (describe)		Torque converter with clutch 125c
Selector	Location	Column or floor
	Ltr./No. designation	P-R-N-D-2-1
Gear ratios	1st	2.84
	2nd	1.60
	3rd	1.00*
	4th	Not available
	Reverse	2.07
Max. upshift speed - drive range [km/h (mph)]		1-2=76(47), 2-3=124(77)
Max. kickdown speed - drive range [km/h (mph)]		2-1=69(43), 3-2=117(73)
Min. overdrive speed [km/h (mph)]		Not Available
Torque converter	Number of elements	3
	Max. ratio at stall	2.35
	Type of cooling (air, liquid)	Liquid
	Nominal diameter	245 (9.65)
Lubricant	Capacity (refill L (pt.))	4.6 (10.0)
	Type Recommended	Dexron II
Oil cooler (std., opt., NA, internal, external, air, liquid)		Standard, integral part of radiator
		* - Converter clutch engagement

Axle or Front Wheel Drive Unit

Type (front, rear)		Front	
Description		Front differential w/helical gears and tapered roller bearings	
Limited slip differential (type)		Not available	
Drive pinion offset		"	
Drive pinion (type)		"	
No. of differential pinions		2	
Pinion / differential adjustment (shim, other)		None	
Pinion / differential bearing adjustment (shim, other)		Shim	
Driving wheel bearing (type)		Sealed ball bearings (integral part of bolt-in hub units)	
Lubricant	Capacity [L (pt.)]	Part of automatic trans. lub.	
	Type recommended	Transmission same as auto.	
	SAE viscosity number	Summer	" " "
		Winter	" " "
		Extreme cold	" " "

Axle or Transaxle Ratio and Tooth Combinations (See 'Power Teams' for axle ratio usage.)

Axle ratio (or overall top gear ratio)		2.84	3.65	2.39
No. of teeth	Pinion or drive gear	35	23	
	Ring gear or gear drive gear	35	84	
Ring gear o.d. or drive gear o.d.		195.2		
Transaxle	Transfer gear ratio	--	--	--
	Final drive ratio	--	--	--

MVMA Specifications Form Passenger Car

Car Line CELEBRITY
 Model Year 1987 Issued 6-86 Revised (e) 9-86

METRIC (U.S. Customary)

Engine Description/Carb.
Engine Code

2.8 Liter V6 (173 CID)
2.8 Multi-Port FI
RPO LB6

Automatic Transmission/Transaxle

Trade name	3-speed automatic	4-speed automatic
Type and special features (describe)	Torque converter with clutch 125c	440-T4
Selector	Location	Column or floor
	Ltr./No. designation	P-R-N-D-2-1
Gear ratios	1st	2.84
	2nd	1.60
	3rd	1.00*
	4th	Not Available
	Reverse	2.07
Max. upshift speed - drive range (km/h (mph))	1-2=76(47), 2-3=132(82)	1-2=69 (43), 2-3=124 (77)
Max. kickdown speed - drive range (km/h (mph))	3-2=125(78), 2-1=66(41)	3-2=111 (69), 2-1=58 (36)
Min. overdrive speed (km/h (mph))	Not Available	60 (37)
Torque converter	Number of elements	3
	Max. ratio at stall	2.35
	Type of cooling (air, liquid)	Liquid
	Nominal diameter	245 (9.65)
Lubricant	Capacity (refill L (pt.))	4.6 (10.0)
	Type Recommended	Dextron II
Oil cooler (std., opt., NA, internal, external, air, liquid)	Standard, integral part or radiator	

* - Converter clutch engagement

Axle or Front Wheel Drive Unit

Type (front, rear)	Front		
Description	Front differential w/helical gears and tapered roller bearings		
Limited slip differential (type)	Not Available		
Drive pinion offset	"		
Drive pinion (type)	"		
No. of differential pinions	2		
Pinion / differential adjustment (shim, other)	None		
Pinion / differential bearing adjustment (shim, other)	Shim		
Driving wheel bearing (type)	Sealed ball bearings (integral part of bolt-in hub unit)		
Lubricant	Capacity (L (pt.))	Part of automatic trans. lub.	
	Type recommended	Transmission same as auto.	
	SAE viscosity number	Summer	" " "
		Winter	" " "
		Extreme cold	" " "

Axle or Transaxle Ratio and Tooth Combinations (See 'Power Teams' for axle ratio usage.)

Axle ratio (or overall top gear ratio)	2.84	3.06	3.18
No. of teeth	Pinion (Drive Gear)	35	35
	Ring gear (Drive Gear)	35	35
Ring gear o.d. (Pitch Dia.)	*195.2		
Transaxle	Transfer gear ratio	--	--
	Final drive ratio	--	--

* - Driven gear

MVMA Specifications Form Passenger Car

Car Line CELEBRITY
 Model Year 1987 Issued 6-86 Revised (●) 9-86

METRIC (U.S. Customary)

Engine Description/Carb.
 Engine Code

2.5L L4 (151 CID)
 Elect. Fuel Inj.
 RPD LR8

Axle Shafts - Front Wheel Drive

Manufacturer and number used		Two		
Type (straight, solid bar, tubular, etc.)	Left	Straight, solid bar		
	Right	Straight, solid bar		
Outer diam. x length* x wall thickness	Manual transmission	Left	Not Applicable	
		Right	Not Applicable	
	Automatic transmission	Left	23.91x346.40(3-spd)(1)@	
		Right	23.91x456.40(3-spd)(1)@	
	Optional transmission	Left	None	
		Right	None	
Slip yoke	Type	None		
	Number of teeth	None		
	Spline o.d.	None		
Universal joints	Make and mfg. no.	Inner	Saginaw	
		Outer	Saginaw	
	Number used	Four 2 each shaft		
	Type, size, plunge	Inner	Tripot (2)	
		Outer	Rzeppa, fixed	
	Attach (u-bolt, clamp, etc.)	Splined		
	Bearing	Type (plain, anti-friction)	Anti-friction	
Lubrication (fitting, prepack)		Prepacked		
Drive taken through (torque tube, arms or springs)		Wishbone lower control arm, upper MacPherson strut		
Torque taken through (torque tube, arms or springs)		Engine mounting system		

* Centerline to centerline of universal joints, or to centerline of attachment.

@ - Shaft capacity = 2300 N.m

% - Shaft capacity = 2700 N.m

(1) Heavy duty suspension = Left - 27.05 x 346.60%

Right - 27.05 x 462.60%

(2) Plunge = Manual, Left - 17.73 Manual, Right - 22.00

Auto-3, Left - 21.88 Auto-3, Right - 24.58

Auto-4, Left - 21.38 Auto-4, Right - 20.08

MVMA Specifications Form Passenger Car

Car Line CELEBRITY
Model Year 1987 Issued 6-86 Revised (#) 9-86

METRIC (U.S. Customary)

Engine Description/Carb.
Engine Code

2.8 Liter - V6
2.8 Multi-Port FI
RPO LB6

Axle Shafts - Front Wheel Drive

Manufacturer and number used		Two	
Type (straight, solid bar, tubular, etc.)		Left	Straight, solid bar
		Right	Straight, solid bar
Outer diam. x length* x wall thickness	Manual transmission	Left	23.91 x 352.95(1)@
		Right	23.91 x 757.15(1)@
	Automatic transmission	Left	23.91 x 346.40@ (2) (3-spd.), 23.91 x 341.90@ (3) (4-spd.)
		Right	23.91 x 456.40@ (2) (3-spd.), 23.91 x 418.45@ (3) (4-spd.)
	Optional transmission	Left	None
		Right	None
Slip yoke	Type		None
	Number of teeth		None
	Spline o.d.		None
Universal joints	Make and mtg. no.	Inner	Saginaw
		Outer	Saginaw
	Number used		Four, two each shaft
	Type, size, plunge	Inner	Tripot (4)
		Outer	Rzeppa, fixed
	Attach (u-bolt, clamp, etc.)		Splined
	Bearing	Type (plain, anti-friction)	Anti-friction
Lubrication (fitting, prepack)		Prepacked	
Drive taken through (torque tube, arms or springs)		Wishbone lower control arm, upper MacPherson strut	
Torque taken through (torque tube, arms or springs)		Engine mounting system	

* Centerline to centerline of universal joints, or to centerline of attachment.

@ - Shaft capacity = 2300 N.m

% - Shaft capacity = 2700 N.m

- (1) Heavy duty suspension = Left - 27.05 x 366.60%
Right - 27.05 x 771.60%
- (2) Heavy duty suspension = Left - 27.05 x 346.60%
Right - 27.05 x 462.60%
- (3) Heavy duty suspension = Left - 27.05 x 346.60%
Right - 27.05 x 428.60%
- (4) Plunge = Manual, Left - 17.73 Manual, Right - 22.00
Auto-3, Left - 21.88 Auto-3, Right - 24.58
Auto-4, Left - 21.38 Auto-4, Right - 20.08

MVMA Specifications Form Passenger Car

Car Line CELEBRITY
Model Year 1987 Issued 6-86 Revised (e) _____

METRIC (U.S. Customary)

Body Type And/Or
Engine Displacement

ALL

Suspension - General

Car leveling	Std./opt./n.a.	Not available on 1AW19, 27; Rear shocks opt. on 1AW35.
	Type (air, hyd., etc.)	Air Inflatable
	Manual/auto. controlled	Manual
Provision for brake dip control		Front suspension geometry
Provision for accel. squat control		Rear suspension geometry
Provisions for car jacking		Body pickup at rocker panels
Shock absorber (front & rear)	Type	Front: MacPherson strut; Rear: direct, double acting
	Make	Delco
	Piston diameter	Front: 32 (1.26); Rear: 25 (1.00)
	Rod diameter	Front 20.0 (.80), ZV8 22.0 (.87), rear 12.5 (.50)

Suspension - Front

Type and description		MacPherson strut with coil springs, stamped lower control arms and nodular iron steering knuckles
Travel	Full jounce	95.0 mm (3.7 in)
	Full rebound	89.0 mm (3.5 in)
Spring	Type (coil, leaf, other) & material	Coil, Steel
	Insulators (type & material)	
	Size (coil design height & i.d., bar length x dia.)	260 (10.3) height at checking load; 165.1 (6.5) I.D.; 2768 (108.9) length; 136 (0.54) dia.
	Spring rate (N/mm (lb./in.))	Base 14.5(83.0)F40-23.5(134.0)F41-16.0(91.0)
	Rate at wheel (N/mm (lb./in.))	Base 17.6(100.0)F40-26.08(149.0)F41-19.0(108.0)
Stabilizer	Type (link, linkless, frameless)	Link
	Material & bar diameter	Steel; Base 22 (.87), ZV8 28 (1.10), wagon 24 (.94)

Suspension - Rear

Type and description		Trailing arm with stamped control arms and open section transverse beam
Travel	Full jounce	105.0 mm (4.1 in)
	Full rebound	95.0 mm (3.7 in)
Spring	Type (coil, leaf, other) & material	Coil, Steel
	Size (length x width, coil design height & i.d., bar length & dia.)	254 (10) height at checking load; 108.0 (4.3) I.D.; 2282 (89.8) length; 12.4 (0.49) dia.
	Spring rate (N/mm (lb./in.))	Base & F41-26.9 (153.7), F40-40.5 (231.0)
	Rate at wheel (N/mm (lb./in.))	Base & F41-15.5 (88.7), F40-22.72 (130.0)
	Insulators (type & material)	Rubber insulator top and bottom
	If leaf	No. of leaves
Shackle (comp. or tens.)		--
Stabilizer	Type (link, linkless, frameless)	Linkless, function performed by axle beam (specific design with F41)
	Material & bar diameter	Steel, 20 mm (.79)
Track bar (type)		Transverse link-open section

**MVMA Specifications Form
Passenger Car
METRIC (U.S. Customary)**

Car Line CELEBRITY
Model Year 1987 Issued 6-86 Revised (e) _____

Body Type And/Or
Engine Displacement

Sedan/Coupe Base	Sedan/Coupe Medium & Heavy Weight (Also Police)
---------------------	---

Brakes - Service

Description		Single Caliper Disc Front, Duo-Servo Drum Rear			
Manufacturer and brake type (std., opt., n.a.)	Front (disc or drum)	Disc			
	Rear (disc or drum)	Drum			
Self-adjusting (std., opt., n.a.)		Standard			
Special valving	Type (proportion, delay, metering, other)	Proportioning, Diagonal Split Circuit			
	Power brake (std., opt., n.a.)	Standard			
Booster type (remote, integral, vac., hyd., etc.)		Tandem Vacuum			
Vacuum source (inline, pump, etc.)		In-Line (Intake Manifold)			
Vacuum reservoir (volume in. ³)		None			
Vacuum pump-type (elec. gear driven, belt driven, if other so state)		None			
Anti-lock device type (std., opt., n.a.) (F/R)		Not Available			
Effective area [cm ² (in. ²)]*		558 (86.5)			
Gross lining area [cm ² (in. ²)]**(F/R)		553 (85.7)			
Swept area [cm ² (in. ²)]**(F/R)		1803 (279.5)	1787 (277.0)		
Rotor	Outerworking diameter	F/R	242.4mm (9.54 in) / 256.4 (10.1)		
	Inner working diameter	F/R	149.6mm(5.89in)otr, 141.3mm / 172.0mm(6.81in)otr, 166.7		
	Thickness	F/R	22mm (0.866 in) (5.56in)inr / 26mm (1.02 in) (6.56in, inr		
	Material & type (vented/solid)	F/R	Cast Iron, Vented		
Drum	Diameter & width	F/R	225x45mm (8.85x1.77 in)		
	Type and material	F/R	Composite, Cast Iron		
Wheel cylinder bore			57mm(2.24in)/17.5mm(0.689in) / 64mm(2.50in)/19mm(0.74in)		
Master cylinder	Bore/stroke	F/R	% / #		
Pedal arc ratio		3.5:1			
Line pressure at 445 N(100 lb.) pedal load (kPa (psi))		12366 (1793)			
Lining clearance		F/R	Self-Adjust.:Frt-0,Rr-.381mm		
Brake lining	Front wheel	Bonded or riveted (rivets/seg.)		Riveted	Integrally Molded
		Rivet size		5.33x9.63mm (0.210x0.379) / --	
		Manufacturer		Delco Moraine	
		Lining code*****		DM 8032	DM 8032 DL (HEIM)
		Material		Semi-Metallic	
		***	Primary or out-board	125x46x10mm (4.92x1.81x.39in)	
		Size	Secondary or in-board	125x46x11mm (4.92x1.81x.43in)	
	Shoe thickness (no lining)		Inboard 5, Outboard 3		
	Rear wheel	Bonded or riveted (rivets/seg.)		Riveted	
		Manufacturer		Inland	
		Lining Code*****		235 FE	
		Material		Organic	
		***	Primary or out-board	176x44x6mm (6.39x1.73x.24in)	
		Size	Secondary or in-board	208x44x7.6mm (8.19x1.73x.30in)	
Shoe thickness (no lining)		2mm (0.0787 in)			

*Excludes rivet holes, grooves, chamfers, etc.

**Includes rivet holes, grooves, chamfers, etc.

***Total swept area for four brakes. (Drum brake: Widest lining contact width for each brake x its contact circumference.)
(Disc brake: Square of Outer Working Dia. minus Square of inner Working Dia. multiplied by Pi/2 for each brake.)

****Size for drum brakes includes length x width x thickness.

*****Manufacturer I.D., catalog or formulation designation and coefficient of friction classification.

%-22.2 & 31.8(0.87 & 1.25)/35.75(1.41)
#-24.0 & 31.8(0.94 & 1.25)/35.75(1.41)

MVMA Specifications Form Passenger Car

Car Line CELEBRITY
Model Year 1987 Issued 6-86 Revised (•) _____

METRIC (U.S. Customary)

Body Type And/Or
Engine Displacement

Station Wagon Base	Station Wagon Heavy Weight
-----------------------	-------------------------------

Brakes - Service

Description		Single caliper disc front, duo-servo drum rear	
Manufacturer and brake type (std., opt., n.a.)	Front (disc or drum)	DISC	
	Rear (disc or drum)	Drum	
Self-adjusting (std., opt., n.a.)		Standard	
Special valving	Type (proportion, delay, metering, other)	Proportioning, diagonal split circuit	
Power brake (std., opt., n.a.)		Standard	
Booster type (remote, integral, vac., hyd., etc.)		Tandem vacuum	
Vacuum source (inline, pump, etc.)		In line (intake manifold)	
Vacuum reservoir (volume in. ³)		None	
Vacuum pump-type (elec, gear driven, belt driven, if other so state)		None	
Anti-lock device type (std., opt., n.a.) (F/R)		Not Available	
Effective area [cm ² (in. ²)]*		558 (86.5)	
Gross lining area [cm ² (in. ²)]**(F/R)		553 (85.7)	
Swept area [cm ² (in. ²)]*** (F/R)		1787 (277.0)	
Rotor	Outerworking diameter	F/R	256.4mm (10.1)
	Inner working diameter	F/R	177mm (6.97 in) outer, 166.6mm (6.56 in) inner
	Thickness	F/R	26 mm (1.02 in)
	Material & type (vented/solid)	F/R	Cast iron, vented
Drum	Diameter & width	F/R	225 x 45 mm (8.85 x 1.77 in)
	Type and material	F/R	Composite, cast iron, finned
Wheel cylinder bore			64mm(2.50in)/20.6mm(0.81in) 64mm(2.50in)/19.0mm(0.74in)
Master cylinder	Bore/stroke	F/R	% #
Pedal arc ratio		3.5:1	
Line pressure at 445 N(100 lb.) pedal load [kPa (psi)]		12366 (1793)	
Lining clearance		F/R	Self adjusting; Front-0, Rear-.381
Brake lining	Front wheel	Bonded or riveted (rivets/seg.)	Riveted-Front/Integrally Molded-Rear
		Rivet size	5.33x9.63 mm (0.210)
		Manufacturer	Delco Moraine
		Lining code*****	DM 8032
		Material	Semi-Metallic
		**** Primary or out-board	125 x 46 x 10 mm (4.92 x 1.81 x .39 in)
	Size Secondary or in-board	125 x 46 x 11 mm (4.92 x 1.81 x .43 in)	
	Shoe thickness (no lining)	Inboard 5, Outboard 3	
	Rear wheel	Bonded or riveted (rivets/seg.)	Riveted
		Manufacturer	Inland
		Lining Code*****	235 FE
		Material	Organic
**** Primary or out-board		176 x 44 x 6 mm (6.39 x 1.73 x .24 in)	
Size Secondary or in-board		208 x 44 x 7.6 mm (8.19 x 1.73 x .30 in)	
Shoe thickness (no lining)	2 mm (0.0787 in)		

*Excludes rivet holes, grooves, chamfers, etc.

**Includes rivet holes, grooves, chamfers, etc.

***Total swept area for four brakes. (Drum brake: Widest lining contact width for each brake x its contact circumference.)
(Disc brake: Square of Outer Working Dia. minus Square of inner Working Dia. multiplied by Pi/2 for each brake.)

****Size for drum brakes includes length x width x thickness.

*****Manufacturer I.D., catalog or formulation designation and coefficient of friction classification.

%-22.2 & 31.8(0.87 & 1.25)/35.75(1.41)

#-24.0 & 31.8(0.94 & 1.25)/35.75(1.41)

MVMA Specifications Form Passenger Car

Car Line CELEBRITY
 Model Year 1987 Issued 6-86 Revised (e)

METRIC (U.S. Customary)

Body Type And/Or
Engine Displacement

Sedan, Coupe & Station Wagon	Eurosport (RPO ZV8)
---------------------------------	------------------------

Tires And Wheels (Standard)

Tires	Size (load range, ply)	P185/75R14, BW*	P195/75R14, BW*	
	Type (bias, radial, etc.)	Stl Btd Radial	Stl Btd Radial	
	Inflation pressure (cold) for recommended max. vehicle load	Front (kPa (psi))	240 (35)	205 (30)
		Rear (kPa (psi))	240 (35)	205 (30)
	Rev. mile-at 70 km/h (45 mph)	526	508	
Wheels	Type & material	Steel	Steel	
	Rim (size & flange type)	14 x 5.5	14 x 5.5	
	Wheel offset	42.0 (1.65)	42.0 (1.65)	
	Attachment	Type (bolt or stud)	Stud	Stud
		Circle diameter	100.0 (3.94)	100.0 (3.94)
Number & size		5, M12 x 1.5	5, M12 x 1.5	
Spare	Tire and wheel (same, if other describe)	T125/70D15	T125/70D15	
	Storage position & location (describe)	Horizontal, under load floor, except wagon which is stowed vertically in R.H. quarter area, behind wheelhouse.		

Tires And Wheels (Optional)

Size (load range, ply)	P185/75R14, WS*	P195/70R14, BW*
Type (bias, radial, etc.)	Stl Btd Radial	Stl Btd Radial
Wheel (type & material)	Steel	Aluminum
Rim (size, flange type and offset)	14x5.5, 42.0	14x6.5, 34.0
Size (load range, ply)		
Type (bias, radial, etc.)		
Wheel (type & material)		
Rim (size, flange type and offset)		
Size (load range, ply)	P195/75R14, BW*	
Type (bias, radial, etc.)	Stl. Btd. Radial	
Wheel (type & material)	Steel	
Rim (size, flange type and offset)	14x6.5, 42.0	
Size (load range, ply)		
Type (bias, radial, etc.)		
Wheel (type & material)		
Rim (size, flange type and offset)		
Spare tire and wheel (if configuration is different than road tire or wheel, describe optional spare tire and/or wheel location & storage position)		

* - Tires are "All Seasons" mud and snow, 4th generation, GM TPC.

Brakes - Parking

Type of control	Foot pedal-application; "T" handle - release	
Location of control	Under instrument panel, left of steering column	
Operates on	Rear service brakes	
If separate from service brakes	Type (internal or external)	--
	Drum diameter	--
	Lining size (length x width x thickness)	--

MVMA Specifications Form Passenger Car

Car Line CELEBRITY
 Model Year 1987 Issued 6-86 Revised (#) 9-86

METRIC (U.S. Customary)

Body Type And/Or
Engine Displacement

ALL

Steering

Manual (std., opt., n.a.)		Not available		
Power (std., opt., n.a.)		Standard		
Adjustable steering wheel/column (lift, telescope, other)	Type	Tilt		
	Manufacturer			
	(Std., opt., n.a.)	Optional		
Wheel diameter** (W9) SAE J1100	Manual	--		
	Power	375.0 (14.76)		
Turning diameter m (ft.)	Outside front	Wall to wall (l. & r.)	12.190 (39.99)	
		Curb to curb (l. & r.)	11.268 (36.96)	
	Inside rear	Wall to wall (l. & r.)	Not available	
		Curb to curb (l. & r.)	Not available	
Scrub Radius*		Not available		
Manual	Gear	Type	Not available	
		Manufacturer	Not available	
		Ratios		
	Gear	Overall	Not available	
		No. wheel turns (stop to stop)		Not available
Power	Type (coaxial, linkage, etc.)		Rack and pinion, integral pump	
	Manufacturer		Saginaw Steering Gear	
	Gear	Type	Rack and pinion with Integral Power Unit	
		Ratios	Gear	"c" Factor=45.13 mm per degree of revolution (17.56:1 ratio)
		Overall	15.7:1 c = 50 for Eurosport	
	Pump (drive)		Belt off crankshaft pulley	
No. wheel turns (stop to stop)		3.05		
Linkage	Type		End take-off tie rods	
	Location (front or rear of wheels, other)		Rear of front wheel centerline	
	Tie rods (one or two)		Two	
Steering axis	Inclination at camber (deg.)		14.6°	
	Bearings (type)	Upper	Ball bearing	
		Lower	Ball joint	
		Thrust	Ball bearing	
Steering spindle & joint type		MacPherson strut with lower ball joint		
Wheel spindle/hub	Diameter	Inner bearing	Not applicable to integral bearings. Service only	
		Outer bearing	Assembly	
	Thread (size)		Not applicable	
	Bearing (type)		Integral double row ball, permanently lubricated	

*The horizontal distance in the front elevation between wheel centerline and kingpin (ball joint) axis at ground.

**See Page 21.

MVMA Specifications Form Passenger Car

Car Line CELEBRITY
 Model Year 1987 Issued 6-86 Revised (e)

METRIC (U.S. Customary)

Body Type And/Or
 Engine Displacement

ALL

Wheel Alignment

Front wheel at curb mass (wt.)	Service checking	Caster (deg.)	1.7° +/- 1.0
		Camber (deg.)	0.0° +/- 1.0° left & right side should be equal
		Toe-in (outside track-mm (in.))	0.0° +/- 0.4° total within 1.0°
	Service reset*	Caster	Not adjustable
		Camber	0.0° +/- 0.5° left & right side should be equal
		Toe-in	0.0° +/- 0.2° total within 0.5°
Periodic M.V. in- spection	Caster	Not adjustable	
	Camber	0.0° +/- 1.0°	
	Toe-in	0.0° +/- 0.4° total	
Rear wheel at curb mass (wt.)	Service checking	Camber (deg.)	Not Available
		Toe-in (outside track-mm (in.))	"
	Service reset*	Camber	"
		Toe-in	"
	Periodic M.V. in- spection	Camber	"
		Toe-in	"

* Indicates pre-set, adjustable, trend set or other.

Electrical - Instruments and Equipment

Speed- ometer	Type (analog, digital, std., opt.)	In-line with pointer, 6 wheel odometer
	Trip odometer (std., opt., n.a.)	Optional
EGR maintenance indicator		Not Available
Charge indicator	Type	Tell-tale warning light
	Warning device (light, audible)	Not Available
Temperature indicator	Type	Tell-tale warning light
	Warning device (light, audible)	Not Available
Oil pressure indicator	Type	Tell-tale warning light
	Warning device (light, audible)	Not Available
Fuel indicator	Type	Electric gage with pointer
	Warning device (light, audible)	Not Available
Wind- shield wiper	Type (standard)	Electric two speed, non-articulated
	Type (optional)	Intermittent
	Blade length	457.2 (18.0)
	Swept area (cm ² (in. ²))	5751 (891.6)
Wind- shield washer	Type (standard)	Electric, integral pump/motor, dual nozzle fan spray
	Type (optional)	Not Available
	Fluid level indicator (light, audible)	Not Available
Rear window wiper, wiper/washer (std., opt., n.a.)		Optional wagon
Horn	Type	Electric vibrator
	Number used	Two, A & F notes standard
Other		Standard: restraint system warning light and buzzer, parking brake and brake failure warning light Optional: voltmeter, oil pressure, coolant temperature gages, clock (with radio), tachometer, rear window defogger indicator light, tailgate window wiper/washer.

MVMA Specifications Form Passenger Car

Car Line CELEBRITY
 Model Year 1987 Issued 6-86 Revised (e) 9-86

METRIC (U.S. Customary)

Engine Description/Carb.
 Engine Code

2.5L L4 (151 CID)
 Elect. Fuel Inj.
 RPO LR8

Electrical - Supply System

Battery	Manufacturer	Delco Remy
	Model, std., (opt.)	75-630 Std, N.A., Opt
	Voltage	12 Volt
	Amps at 0°F cold crank	630 Std, N.A. Opt.
	Minutes-reserve capacity	90 Std, N.A. Opt.
	Amp/hrs. - 20 hr. rate	--
Location		Engine compartment
Alternator	Manufacturer	Delco Remy
	Rating	(a,b,c)
	Ratio (alt. crank/rev.)	Not Available
	Optional (type & rating)	None
Regulator	Type	Integral with alternator

Electrical - Starting System

Start. motor	Current drain at 0°F	270*
Motor drive	Engagement type	Overrunning clutch
	Pinion engages from (front, rear)	Front

Electrical - Ignition System

Type	Electronic (std., opt., n.a.)	Not available	
	Other (specify)	Computer controlled coil ignition (C ³ I)	
Coil	Make	Delco-Remy	
	Model	Not Available	
	Current	Engine stopped - A	Not Available
		Engine idling - A	Not Available
Spark plug	Make	AC	
	Model	R44TSX	
	Thread (mm)	14	
	Tightening torque (N-m (lb. ft))	20 (15)	
	Gap	1.52 (.060)	
Distributor	Number per cylinder	One	
	Make	Not Applicable	
	Model	Not Applicable	

Electrical - Suppression

Locations & type Internal alt. capacitor, non-metallic high-tension ignition cables, resistor spark plugs, ignition coil by-pass capacitor, internal AC blower motor by-pass capacitor & A/C compression diode, with radio provisions; hood grounding clip, engine to dash panel ground strap, fuse block capacitor and on "heater only" blower motors and coax capacitor.

- (a) - 56 amp with heater, 10 SI (22 amp @ idle).
- (b) - 66 amp with heater and heated backlite, 10 SI (23 amp @ idle).
- (c) - 78 amp with A/C, 15 SI (40 amp @ idle).
- * - Current drain for starting motor is at -20°F.

MVMA Specifications Form Passenger Car

Car Line CELEBRITY
 Model Year 1987 Issued 6-86 Revised (e) 9-86

METRIC (U.S. Customary)

Engine Description/Carb.
 Engine Code

2.8 Liter - V6
 2.8 Multi-Port FI
 RPO LB6

Electrical - Supply System

Battery	Manufacturer	Delco Remy
	Model, std., (opt.)	70-525 (Std.), 75-570 (Opt.)
	Voltage	12 Volts
	Amps at 0°F cold crank	525 (Std.), 570 (Opt.)
	Minutes-reserve capacity	75 (Std.), 90 (Opt.)
	Amp/hrs. - 20 hr. rate	--
Alternator	Location	Engine Compartment
	Manufacturer	Delco Remy
	Rating	(a,b,c)
	Ratio (alt. crank/rev.)	Not Available
Regulator	Optional (type & rating)	None
	Type	Integral with alternator

Electrical - Starting System

Start. motor	Current drain at 0°F	250 @ -20°F
	Engagement type	Positive shift solenoid
Motor drive	Pinion engages from (front, rear)	Rear

Electrical - Ignition System

Type	Electronic (std., opt., n.a.)	Not Applicable	
	Other (specify)	Computer controlled coil ignition (C ³ I)	
Coil	Make	Delco-Remy	
	Model	1115463	
	Current	Engine stopped - A	Not Available
		Engine idling - A	Not Available
Spark plug	Make	AC	
	Model	R43C1SE	
	Thread (mm)	M14 x 1.25	
	Tightening torque (N-m (lb. ft))	9-20 (7-15)	
	Gap	1.143 (.045)	
	Number per cylinder	One	
Distributor	Make	Not Applicable	
	Model	Not Applicable	

Electrical - Suppression

Locations & type Internal alt. capacitor, non-metallic high-tension ignition cables, resistor spark plugs, ignition coil by-pass capacitor, internal AC blower motor by-pass capacitor & A/C compression diode, with radio provisions; hood grounding clip, engine to dash panel ground strap, fuse block capacitor and on "heater only" blower motors and coax capacitor.

- (a) - 66 amp with heater
- (b) - 78 amp with heater and heated backlite
- (c) - 97 amp with A/C

MVMA Specifications Form Passenger Car

Car Line CELEBRITY
Model Year 1987 Issued 6-86 Revised (#) _____

METRIC (U.S. Customary)

Body Type	2-Door Notchback Coupe 1AW27	4-Door Notchback Sedan 1AW19	4-Door Station Wagon 1AW35
------------------	------------------------------------	------------------------------------	----------------------------------

Body

Structure	Integral steel body/frame construction incorporating welded front end structural framing for mounting front sheet metal. Halo roof design, double panel deck lid (sedan, coupe). Slim profile door construction with rolled-section upper frame; bolted-on hinges.
Bumper system front - rear	Steel facebar/impact bar design supported by energy absorbing cylinders for impact management.
Anti-corrosion treatment	High level of corrosion protection through extensive use of zinc-rich precoated metal and underbody primer, augmented by wax-base spray on doors, deck lid lower surfaces and hinge pillars. Plastisol applied to selected lower body areas.

Body - Miscellaneous Information

Type of finish (lacquer, enamel, other)	Acrylic lacquer or waterbase acrylic enamel	
Hood	Hinge location (front, rear)	Rear
	Type (counterbalance, prop)	No counterbalance, Prop rod type
	Release control (internal, external)	Internal
Trunk lid	Type (counterbalance, other)	Torsion bar counterbalance
	Internal release control (elec., mech., n.a.)	External mechanical std; Internal elect. opt.
Hatch-back lid	Type (counterbalance, other)	Not Applicable
	Internal release control (elec., mech., n.a.)	Not Applicable
Station wagon		
Vent window control (crank, friction, pivot, power)	Front	None
	Rear	None
Seat cushion type (e.g., 60/40, bucket, bench, wire, foam etc.)	Front	Molded polyurethane padding
	Rear	Molded polyurethane padding
	3rd seat	--
Seat back type (e.g., 60/40, bucket, bench, wire, foam etc.)	Front	Molded polyurethane padding
	Rear	Molded polyurethane padding
	3rd seat	--

MVMA Specifications Form
Passenger Car
METRIC (U.S. Customary)

Car Line CELEBRITY
 Model Year 1987 Issued 6-86 Revised (e) _____

Body Type	2-Door Notchback Coupe 1AW27	4-Door Notchback Sedan 1AW19	4-Door Station Wagon 1AW35
------------------	------------------------------------	------------------------------------	----------------------------------

Restraint System

Active restraint system	Standard/optional	Standard
	Type and description	3 point shoulder and lap belt for driver and R.H. frt, and rear seat outboard pass. Lap belt for all other positions,
	Location	Front-(3); Rear-(3); Station wagon 3rd seat - (2) secured by buckle w/push button release
Passive seat belts	Standard/optional	Not available
	Power/manual	"
	2 or 3 point	"
	Knee bar/lap belt	"

Frame

Type and description (separate frame, unitized frame, partially-unitized frame)	Unitized FRAME. Bolt-on power train cradle (2-piece design) with mounting provisions for suspension lower control arms and engine mounts
---	--

Glass	SAE Ref. No.			
Windshield glass exposed surface area (cm ² (in. ²))	S1	8525 (1321.4)		
Side glass exposed surface area (cm ² (in. ²)) - total 2-sides	S2	11412 (1768.9)	11254 (1744.4)	17738 (2749.4)
Backlight glass exposed surface area (cm ² (in. ²))	S3	3550 (550.2)		5837 (904.7)
Total glass exposed surface area (cm ² (in. ²))	S4	23487 (3640.5)	23329 (3616.0)	32100 (4975.5)
Windshield glass (type)		Curved - Laminated Plate		
Side glass (type)		Curved - Tempered Plate		
Backlight glass (type)		Curved - Tempered Plate		

MVMA Specifications Form
Passenger Car
METRIC (U.S. Customary)

Car Line CELEBRITY
 Model Year 1987 Issued 6-86 Revised (e) _____

Body Type

2-Door Notchback Coupe	4-Door Notchback Sedan	4-Door Station Wagon
---------------------------	---------------------------	-------------------------

Convenience Equipment (standard, optional, n.a.)

Air conditioning (manual, auto. temp control)	Optional - manual control	
Clock (digital, analog)	Digital-opt. with mono radios; incl. w/stereo radio equip.	
Compass / thermometer	Not Available	
Console (floor, overhead)	Optional (floor)	
Defroster, elec. backlight	Optional	
Electronic	Diagnostic monitor (integrated, individual)	Not Available
	Instrument cluster (list instruments)	"
	Keyless entry	"
	Tripminder (avg. spd., fuel)	"
	Voice alert (list items)	"
	Other	"
	--	
Fuel door lock (remote, key, electric)	Not Available	
Lamps	Auto head on / off delay, dimming	"
	Cornering	"
	Courtesy (map, reading)	Optional
	Door lock, ignition	"
	Engine compartment	"
	Fog	Not Available
	Glove compartment	Standard
	Trunk	Optional
	Other	Ash tray lamp - standard
		--
Mirrors	Day/night (auto, man.)	Standard - manual
	L.H. (remote, power, heated)	Standard - manual, Remote optional
	R. H. (convex, remote, power, heated)	Optional - convex
	Visor vanity (RH, LH, illuminated)	Optional - RH, illuminated or non-illuminated
Parking brake-auto release (warning light)	Warning light, standard	
Power equipment	Door locks / deck lid - specify	Optional-power (both door & deck lid & wagon gate release)
	Seat (2-4-6 way) heated (driver, pass, other) lumbar, hip, thigh support (power, manual) reclining (driver, pass) memory (1-2 preset, recline)	Optional - 6-way power bench seat - 6-way 45/45 power bench seat, power driver seat only. Recliner, left & right.
	Side windows	Optional
	Vent windows	Not Available
	Rear window	"
		--
Radio systems	Antenna (location, whip, w/shield, power)	Mast, fender
	AM, FM, stereo, tape, CB	Standard AM, optional FM/FM, AM/FM stereo, AM/FM cassette
	Speaker (number, location) Premium sound	Optional, extended range rear
Roof open air fixed (flip-up, sliding, "T")	Sunroof, optional	
Speed control device	Optional, includes resume speed & acceleration feature	
Speed warning device (light, buzzer, etc.)	Not Available	
Tachometer (rpm)	Optional	
Telephone system - mobile		
Theft protection-type	Lock mounted on steering column; locks steering wheel, transmission shift lever and ignition.	

MVMA Specifications Form Passenger Car

Car Line CELEBRITY
Model Year 1987 Issued 6-86 Revised (•) _____

METRIC (U.S. Customary) Car and Body Dimensions See Key Sheets for definitions

All dimensions to ground are for comparative purposes only. Dimensions are to be shown for all base body models of each car line. SAE Ref. no. refers to the definition published in SAE Recommended Practice J1100 "Motor Vehicle Dimensions," unless otherwise specified.

Body Type	SAE Ref. No.	2-Door Notchback Coupe 1AW27	4-Door Notchback Sedan 1AW19	4-Door Station Wagon 1AW35
Width				
Tread (front)	W101	1492 (58.7)		
Tread (rear)	W102	1447 (57.0)		
Vehicle width	W103	1760 (69.3)		
Body width at Sg RP (front)	W117	1722 (67.8)		
Vehicle width (front doors open)	W120	3800 (149.6)	3310 (130.3)	
Vehicle width (rear doors open)	W121	--	3174 (125.0)	
Front fender overall width	W106	1760 (69.3)		
Rear fender overall width	W107	1760 (69.3)	1757 (69.2)	1744 (68.7)
Tumble-home (deg.)	W122	21.5°		

Length

Wheelbase	L101	2664 (104.9)		
Vehicle length	L103	4783 (188.3)		4847 (190.8)
Overhang (front)	L104	1034 (40.7)		
Overhang (rear)	L105	1085 (42.7)		1149 (45.2)
Upper structure length	L123	2400 (94.5)		3267 (128.6)
Rear wheel C/L "X" coordinate	L127	2459 (96.8)		
Cowl point "X" coordinate	L125	206 (8.1)	207 (8.2)	
Front end length at centerline	L126			
Rear end length at centerline	L129	804 (31.7)	802 (31.6)	13 (0.5)

Height **

Passenger distribution (front/rear)	PD1.2.3		**	
Trunk/cargo load			**	
Vehicle height	H101	1375 (54.1)		1378 (54.3)
Cowl point to ground	H114	936 (36.8)		934 (36.8)
Deck point to ground	H138			
Rocker panel-front to ground	H112	219 (8.6)		218 (8.6)
Bottom of door closed-front to grd.	H133	290 (11.4)		294 (11.6)
Rocker panel-rear to ground	H111	219 (8.6)		226 (8.9)
Bottom of door closed-rear to grd.	H135	--	291 (11.5)	293 (11.6)
Windshield slope angle	H122	58.0	57.0	
Backlight slope angle	H121	35.0	34.5	47.0

Ground Clearance **

Front bumper to ground	H102	362 (14.2)		356 (14.0)
Rear bumper to ground	H104	354 (13.9)		
Bumper to ground (front at curb mass (wt.))	H103	381 (15.0)		371 (14.6)
Bumper to ground (rear at curb mass (wt.))	H105	379 (14.9)		368 (14.5)
Angle of approach (degrees)	H106	14.4°		14.0°
Angle of departure (degrees)	H107	17.8°		18.8°
Ramp breakover angle (degrees)	H147	15.1°		15.3°
Axle differential to ground (front / rear)	H153	158 (6.2)		
Min. running ground clearance	H156	144 (5.7)		141 (5.6)
Location of min. run. grd. clear.		Front suspension		

**All Vehicle Height And Ground Clearances Are Made Using EPA Loaded Vehicle Weight, Loading Conditions.

EPA LOADED VEHICLE WEIGHT Is The Base Vehicle Weight Plus All Coolant And Fluids Necessary For Operation Plus 100% Of The Fuel Capacity, Plus The Weight Of All Options And Accessories Which Weigh Three Pounds Or More And Which Are Sold On At Least 33% Of The Car Line, Plus Two Occupants.

MVMA Specifications Form

Passenger Car

METRIC (U.S. Customary)

Car and Body Dimensions See Key Sheets for definitions

Car Line CELEBRITY

Model Year 1987

Issued 6-86

Revised (•) _____

Body Type

SAE Ref. No.	2-Door Notchback Coupe 1AW27	4-Door Notchback Sedan 1AW19	4-Door Station Wagon 1AW35
--------------	---------------------------------	---------------------------------	-------------------------------

Front Compartment

Sg RP front, "X" coordinate	L31	1138 (44.8)	
Effective head room	H61	980 (38.6)	
Max. eff. leg room (accelerator)	L34	1070 (42.1)	
SgRP to heel point	H30	258 (10.2)	
SgRP to heel point	L53	862 (33.9)	
Back angle	L40	26.0	
Hip angle	L42	99.5	99.0
Knee angle	L44	127.0	
Foot angle	L46	87.0	
Design H-point front travel	L17	192 (7.6)	
Normal driving & riding seat track trvl.	L23	172 (6.8)	
Shoulder room	W3	1421 (55.9)	1427 (56.2)
Hip room	W5	1329 (52.3)	1330 (52.4)
** Upper body opening to ground	H50		
Steering wheel maximum diameter	W9	375 (14.8)	
Steering wheel angle	H18	22.0	
Accel. heel pt. to steer. whl. cntr	L11		
Accel. heel pt. to steer. whl. cntr	H17		
Steering wheel to C/L of thigh	H13	98 (3.9)	95 (3.7)
Steering wheel torso clearance	L7	364 (14.3)	365 (14.4)
Headlining to roof panel (front)	H37	13 (0.5)	12 (0.5)
Undepressed floor covering thickness	H67	15 (0.6)	

Rear Compartment

All Interior Dimensions Are Measured With The Seating Reference Point (SgRP) _____ mm (1 Seat Adjuster Notch) Forward Of Rearmost Seat Position.

Sg RP Point couple distance	L50	809 (31.9)	786 (30.9)
Effective head room	H63	963 (37.9)	965 (38.0)
Min. effective leg room	L51	910 (35.8)	925 (36.4)
Sg RP (second to heel)	H31	260 (10.2)	261 (10.3)
Knee clearance	L48	34 (1.3)	44 (1.7)
Compartment room	L3	687 (27.0)	709 (27.9)
Shoulder room	W4	1447 (57.0)	1427 (56.2)
Hip room	W6	1362 (53.6)	1338 (52.7)
** Upper body opening to ground	H51		
Back angle	L41	24.5	
Hip angle	L43	83.5	84.5
Knee angle	L45	91.5	94.5
Foot angle	L47	128.5	130.0
Headlining to roof panel (second)	H38	14 (0.6)	13 (0.5)
Depressed floor covering thickness	H73	18 (0.7)	19 (0.7)

Luggage Compartment

Usable luggage capacity (L (cu. ft.))	V1	460 (16.2)	--
** Litter height	H195	900 (35.4)	810 (31.9)
			821 (32.3)

Interior Volumes (EPA Classification)

Vehicle class (subcompact, compact, etc.)		Mid-size	
Interior volume index (cu. ft.)		97.4	97.9
Trunk/cargo index (cu. ft.)		16.2	41.6

All linear dimensions are in millimeters (inches).

** EPA Loaded Vehicle Weight, Loading Conditions

MVMA Specifications Form
Passenger Car
METRIC (U.S. Customary)
Car and Body Dimensions

Car Line CELEBRITY
 Model Year 1987 Issued 6-86 Revised (•) 10-86

See Key Sheets for definitions

Body Type

SAE Ref. No.	4-Door Station Wagon 1AW35
--------------	-------------------------------

Station Wagon - Third Seat Optional-RPO AQ4

Sg RP couple distance	L85	791 (31.1)
Shoulder room	W85	1125 (44.3)
Hip room	W86	1100 (43.3)
Effective leg room	L86	737 (29.0)
Effective head room	H86	920 (36.2)
Sg RP to heel point	H87	282 (11.1)
Knee clearance	L87	310 (12.2)
Seat facing direction	SD1	Rearward
Back angle	L88	25.0
Hip angle	L89	76.5
Knee angle	L90	64.0
Foot angle	L91	99.0

Station Wagon - Cargo Space

Cargo length (open front)	L200	Not Applicable
Cargo length (open second)	L201	Not Applicable
Cargo length (closed front)	L202	1926 (75.8)
Cargo length (closed second)	L203	1152 (45.4)
Cargo length at belt (front)	L204	1856 (73.1)
Cargo length at belt (second)	L205	1029 (40.5)
Cargo width (wheelhouse)	W201	930 (36.6)
Rear opening width at floor	W203	1082 (42.6)
Opening width at belt	W204	1246 (49.1)
• Max. rear opening width above belt	W205	996 (39.2)
Cargo height	H201	803 (31.6)
Rear opening height	H202	729 (28.7)
Tailgate to ground height	H250	821 (32.3)
Front seat back to load floor height	H197	404 (15.9)
Cargo volume index (m ³ (ft. ³))	V2	2127 (75.1)
Hidden cargo volume (m ³ (ft. ³))	V4	--
Cargo volume index-rear of 2-seat	V10	1179 (41.6)

Hatchback - Cargo Space

Cargo length at front seatback height	L208	
Cargo length at floor (front)	L209	
Cargo length at second seatback height	L210	Not Applicable
Cargo length at floor (second)	L211	--
Front seatback to load floor height	H197	
Second seatback to load floor height	H198	
Cargo volume index (m ³ (ft. ³))	V3	--
Hidden cargo volume (m ³ (ft. ³))	V4	
Cargo volume index-rear of 2-seat	V11	--

Aerodynamics*

		Coupe	Sedan	Station Wagon
Wheel lip to ground, front	H172	658 (25.9)	653 (25.7)	657 (25.9)
Wheel lip to ground, rear	H173	652 (25.7)		657 (25.9)
Frontal area (m ² (ft ²))	FA	2.03(21.8)		2.01(21.6)
Drag coefficient (Cd)				

* EPA Loaded Vehicle Weight, Loading Conditions
 All linear dimensions are in millimeters (inches) unless otherwise noted.

MVMA Specifications Form
Passenger Car
METRIC (U.S. Customary)

Car Line CELEBRITY
 Model Year 1987 Issued 6-86 Revised (•) _____

Body Type	2-Door Notchback Coupe 1AW27	4-Door Notchback Sedan 1AW19	4-Door Station Wagon 1AW35
------------------	------------------------------------	------------------------------------	----------------------------------

Vehicle Fiducial Marks

Fiducial Mark Number*	Define Coordinate Location		
Front	X -	Fiducial mark to vertical base grid line - front measured horizontally, from the base grid line to the front fiducial mark located on top of the front seat adjuster mounting bolt.	
	Y -	Fiducial mark to centerline of car - front, width measurement made from centerline car to fiducial mark located on top of the front seat adjuster mounting bolt.	
	Z -	Fiducial mark to horizontal base grid line - front, measured vertically from base grid line to front fiducial mark located on top of the front seat adjuster mounting bolt.	
Rear	X -	Fiducial mark to vertical base grid line - rear, measured horizontally from base grid line to rear fiducial mark located on the rail (compartment pan-longitudinal).	
	Y -	Fiducial mark to centerline of car - rear, width measurement made from centerline of car to fiducial mark located on the rail (compartment pan-longitudinal).	
	Z -	Fiducial mark to horizontal base grid line - rear, measured vertically from base grid line to the rear fiducial mark located on the rail (compartment pan-longitudinal).	
Front	W21	564 (22.2)	
	L54	771 (30.4) *	
	H81	58 (2.3) #	
	H161	308 (12.1)	302 (11.9)
	** H163	286 (11.3)	287 (11.3)
Rear	W22	489 (19.3)	510 (20.1)
	L55	2980 (117.3) *	2215 (87.2) *
	H82	187 (7.4) #	- 14 (-0.6) #
	H162	441 (17.4)	440 (17.3)
	** H164	416 (16.4)	425 (16.7)
* Vertical Base Grid 2000 mm line. # Horizontal Base Grid 200 mm line.			

* Reference - SAE Recommended Practice, J182, Motor Vehicle Fiducial Marks.

All linear dimensions are in millimeters (inches).

** EPA Loaded Vehicle Weight, Loading Conditions

MVMA Specifications Form
Passenger Car
METRIC (U.S. Customary)

Car Line CELEBRITY
 Model Year 1987 Issued 6-86 Revised (e) _____

Body Type	2-Door Notchback Coupe 1AW27	4-Door Notchback Sedan 1AW19	4-Door Station Wagon 1AW35
------------------	------------------------------------	------------------------------------	----------------------------------

Lamps and Headlamp Shape*

Height above ground to center of bulb or marker	Headlamp (SAE - H127)	Highest**	662 (26.1)	669 (26.4)	664 (26.1)
		Lowest	662 (26.1)	669 (26.4)	664 (26.1)
	Taillamp (SAE - H128)	Highest**	647 (25.5)	639 (25.1)	643 (25.3)
		Lowest	--	--	--
	Sidemarker	Front	417 (16.4)	423 (16.7)	418 (16.5)
		Rear	705 (27.8)	697 (27.4)	702 (27.6)
Distance from C-L of car to center of bulb	Headlamp	Inside	462.0 (18.2)		
		Outside**	642.5 (25.3)		
	Taillamp	Inside	284.0 (11.2)		
		Outside**	672.0 (26.5)		
	Directional	Front	463.5 (18.2)		
		Rear	479.0 (18.9)		
Halogen headlamp (std., opt., n.a.)	Lo beam	Std			
	Hi beam	Std			
	Replaceable bulb	Yes			
	Shape	Rectangular			
Headlamp other than above	Lo beam	Not Available			
	Hi beam	" "			
	Replaceable	" "			
	Shape	" "			
	Type	" "			

* Measured at curb mass (weight).
 ** If single lamps are used enter here.
 All linear dimensions are in millimeters (inches) unless otherwise noted.

MVMA Specifications Form Passenger Car

Car Line CELEBRITY
Model Year 1987 Issued 6-86 Revised (e) _____

METRIC (U.S. Customary)

Equipment	Optional Equipment Differential Mass (weight)*			Remarks
	MASS, kg. (weight, lb.)			
	Front	Rear	Total	
Swing-up Tailgate	0	-.4	-.4	1AW35 only
Window RPO AB7	(0)	(-.9)	(.9)	
Power Seat 6-Way (Requires RPO AM6 or AS7)	2.2 (4.8)	2.8 (6.2)	5.0 (11.0)	All models
RPO AG9				
Rear-Facing Third Seat	-.6 (-1.3)	(6.4) (14.1)	5.8 (12.8)	1AW35 only
RPO AQ4				
Bucket Seat RPO AR9	1.4 (3.1)	1.4 (3.1)	2.8 (6.2)	All models
Seat Front 45/45 (Includes Folding Armrest, Armrest deleted with D55 floor console) RPO AS7	1.6 (3.5)	1.6 (3.5)	3.2 (7.0)	2-door model
RPO AS7				4-door model
Power Door Lock System	1.2 (2.6)	1.2 (2.6)	2.4 (5.2)	2-door model
RPO AU3				
	1.4 (3.1)	2.0 (4.4)	3.4 (7.5)	4-door model
Electric Tailgate Release	-.2 (-0.4)	1.0 (2.2)	.8 (1.8)	1AW35 only
RPO AU6				
Swing-out Rear Quarter CV Window RPO A20	-.2 (0.4)	1.0 (2.2)	.8 (1.8)	1AW35 only
Power Windows	.6 (1.3)	1.4 (3.1)	2.0 (4.4)	2-door model
RPO A31				
	1.8 (4.0)	2.8 (6.2)	4.6 (10.2)	4-door model
Power Trunk Opener	-.2 (0.4)	1.0 (2.2)	.8 (1.8)	1AW19 & 27 models
RPO A90				
Deluxe Rr Comp Decor	-.2 (0.4)	1.2 (2.6)	1.0 (2.2)	1AW35 only
RPO BC5				
Estate Equipment RPO BX3	.8 (1.8)	1.6 (3.5)	2.4 (5.3)	1AW35 only

*Also see Engine - General Section for dressed engine mass (weight).

MVMA Specifications Form Passenger Car

Car Line CELEBRITY
Model Year 1987 Issued 6-86 Revised (•) _____

METRIC (U.S. Customary)

Equipment	Optional Equipment Differential Mass (weight)*			Remarks
	MASS, kg (weight, lb.)			
	Front	Rear	Total	
Reclining Driver & Passenger, seat back (Feature included with AR9 bucket seat option) RPO A78	1.0 (2.2)	1.0 (2.2)	2.0 (4.4)	2-door model
Color-Keyed Floor Mats Front RPO B32	1.4 (3.1)	1.0 (2.2)	2.4 (5.3)	All models
Color-Keyed Floor Mats Rear RPO B33	.4 (0.9)	.6 (1.3)	1.0 (2.2)	All models
Rubber Floor Mats Front RPO B34				All models
Rubber Floor Mats Rear RPO B35				All models
Deluxe Luggage Comp Trim RPO B48	0 (0)	3.0 (6.6)	3.0 (6.6)	1AW19, 27 models
Celebrity Classic RPO CB5	2.0 (4.4)	2.0 (4.4)	4.0 (8.8)	1AW19, 27 models, except RPO ZV8 Eurosport.
Intermittent Windshield Wiper System RPO CD4	.2 (0.4)	0	.2 (0.4)	All models
Tailgate window wiper/washer RPO C25	2.8 (6.2)	1.8 (4.0)	4.6 (10.2)	1AW35 only
Electric Rear Window Defogger RPO C49	0 (0)	.6 (1.3)	.6 (1.3)	All models
Rear Window Air Deflector RPO C51	- .8 (-1.8)	3.0 (6.6)	2.2 (4.8)	1AW35 only
Air Conditioning RPO C60	20.2 (44.5)	.8 (1.8)	21.0 (46.3)	1AW19 & 35 with RPO LB6, MD9, ME9 & M19
	22.0 (48.5)	1.0 (2.2)	23.0 (50.7)	1AW27 & RPO LB6
	25.4 (56.0)	1.2 (2.6)	26.6 (58.6)	1AW00 & RPO LRB
Dome Reading Lamp RPO C95	0 (0)	.2 (0.4)	.2 (0.4)	All models

*Also see Engine - General Section for dressed engine mass (weight).

MVMA Specifications Form
Passenger Car
METRIC (U.S. Customary)

Exterior Car And Body Dimensions – Key Sheet

Exterior Width

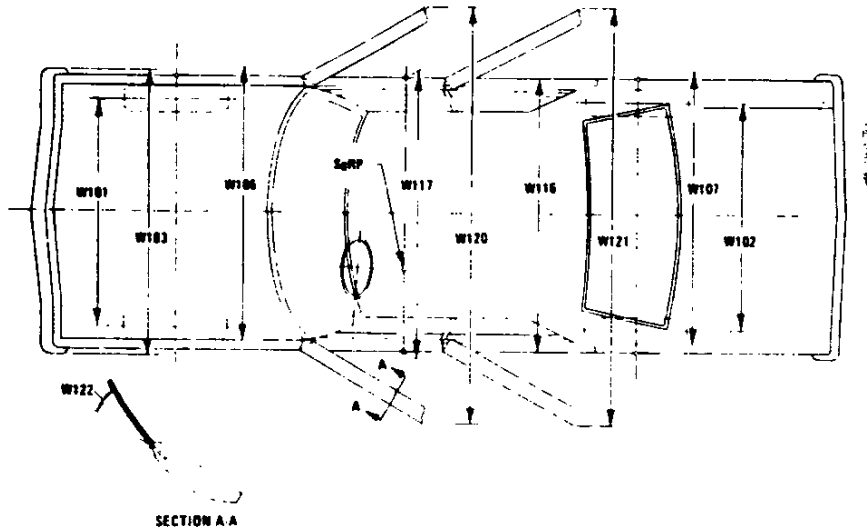

Exterior Length & Height

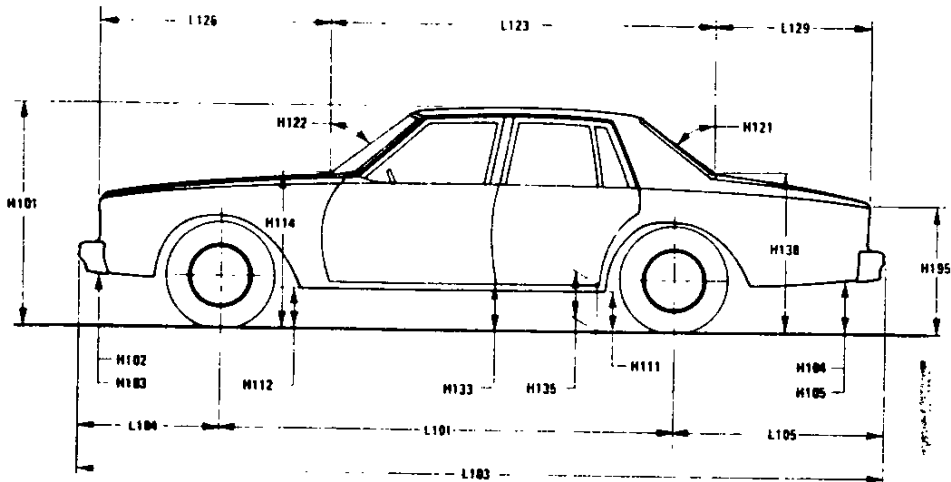

Exterior Ground Clearance

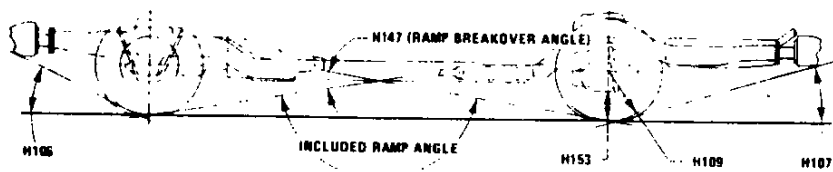

MVMA Specifications Form
Passenger Car
METRIC (U.S. Customary)

Interior Car And Body Dimensions - Key Sheet

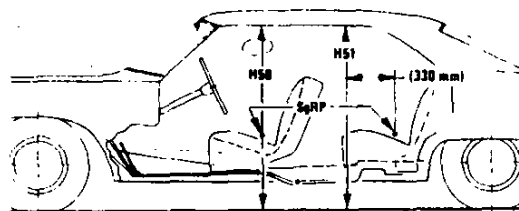
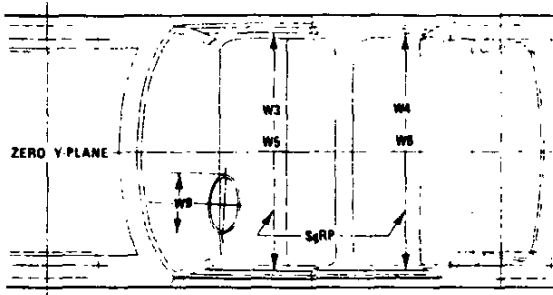
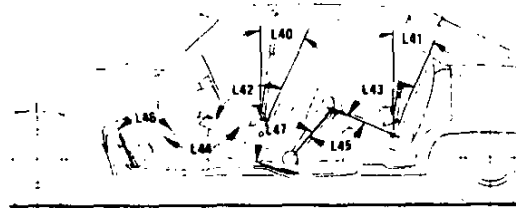
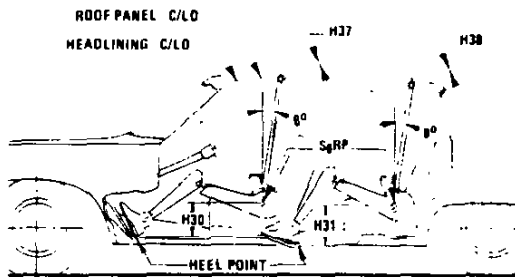
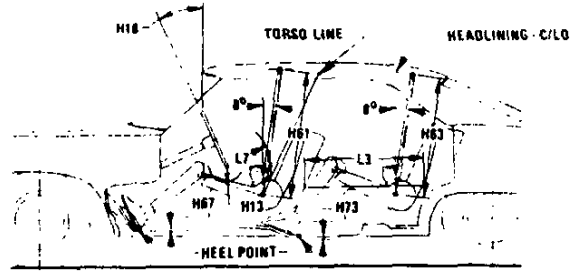
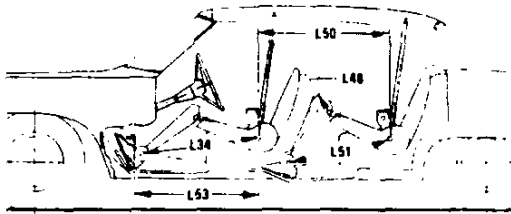

MVMA Specifications Form

Passenger Car

METRIC (U.S. Customary)

Interior Car And Body Dimensions - Key Sheet

Third Seat

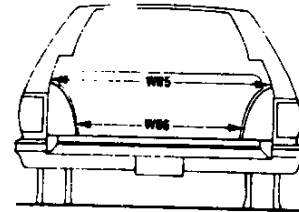
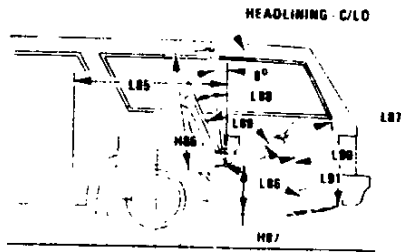

Cargo Space

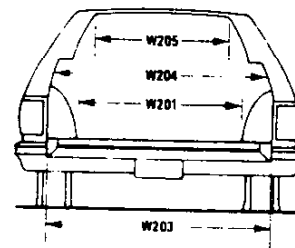
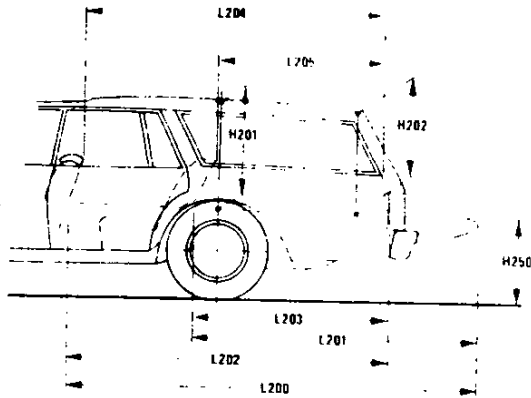

Station Wagon

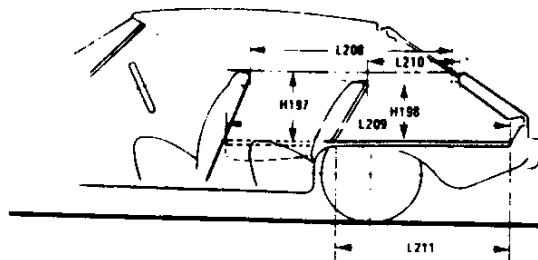

Hatchback

MVMA Specifications Form

Passenger Car

METRIC (U.S. Customary)

Exterior Car And Body Dimensions – Key Sheet

Dimensions Definitions

Seating Reference Point

SEATING REFERENCE POINT means the manufacturer's design reference point which –

- (a) Establishes the rearmost normal design driving or riding position of each designated seating position in a vehicle.
- (b) Has coordinates established relative to the design vehicle structure:
- (c) Simulates the position of the pivot center of the human torso and thigh; and
- (d) Is the reference point employed to position the two dimensional templates described in SAE Recommended Practice J826, "Devices for Use in Defining and Measuring Vehicle Seating Accommodations."

Width Dimensions

- W101 TREAD-FRONT The dimension measured between the tire centerlines at the ground
- W102 TREAD-REAR The dimension measured between the tire centerlines at the ground. In case of dual wheels, the dimension will be measured to the centerline of tire and wheel assemblies
- W103 VEHICLE WIDTH The maximum dimension measured between the widest point on the vehicle, excluding exterior mirrors, flexible mud flaps, marker lamps, but including bumpers, moldings, sheet metal protrusions or dual wheels, if standard equipment
- W106 FRONT FENDER WIDTH The dimension measured between the widest points at the front wheel centerline, excluding moldings.
- W107 REAR FENDER WIDTH The dimension measured between the widest points at the rear wheel centerline, excluding moldings.
- W117 BODY WIDTH AT SgRP-FRONT. The dimension measured laterally between the widest points on the body at the SgRP-front, excluding door handles, applied moldings, or appliques
- W120 VEHICLE WIDTH-FRONT DOORS OPEN. The dimension measured between the widest point on the front doors in maximum hold-open position
- W121 VEHICLE WIDTH-REAR DOORS OPEN. The dimension measured between the widest point on the rear doors in maximum hold-open position. For vehicles with a rear door on only one side, this dimension is to the zero "Y" plane
- W122 TUMBLE-HOME, STRAIGHT SIDE GLASS The angle measured from a vertical to the outside surface of the front door glass at the SgRP "X" plane
CURVED SIDE GLASS The angle measured from a vertical to a chord extending from the upper DLO to the lower DLO at the outside surface of the front door glass at the front SgRP "X" plane.

Length Dimensions

- L101 WHEELBASE (WB). The dimension measured longitudinally between front and rear wheel centerlines. In case of dual rear axles, the dimension shall be to the midpoint of the centerlines of the rear wheels
- L103 VEHICLE LENGTH. The maximum dimension measured longitudinally between the foremost point and the rearmost point on the vehicle, including bumper, bumper guards, tow hooks and/or rub strips, if standard equipment.
- L104 OVERHANG-FRONT. The dimension measured longitudinally from the centerline of the front wheels to the foremost point on the vehicle including bumper, bumper guards, tow hooks and/or rub strips, if standard equipment.
- L105 OVERHANG-REAR. The dimension measured longitudinally from the centerline of the rear wheels; or in the case

of dual rear axles, the dimension shall be the midpoint of the centerlines of the rear wheels, to the rearmost point on the vehicle including rear bumpers, bumper guards, tow hooks and rub strips, if standard equipment.

- L123 UPPER STRUCTURE LENGTH The dimension measured longitudinally from the cowt point to the deck point.
- L125 COWL POINT "X" COORDINATE.
- L126 FRONT END LENGTH. The dimension measured longitudinally from the cowt point to the foremost point on the vehicle at the zero "Y" plane excluding ornamentation or bumpers. In cases where bumpers and/or grills are integrated with the profile, measurement is made at the foremost point of front end contour
- L127 REAR WHEEL CENTERLINE "X" COORDINATE or in the case of dual rear axles, the coordinate shall be the midpoint of the distance between the rear axle centerlines
- L129 REAR END LENGTH. The dimension measured longitudinally from the deck point to the rearmost visible point of the body sheet metal at the zero "Y" plane, excluding ornamentation or bumpers

Height Dimensions

- H101 VEHICLE HEIGHT The dimension measured vertically from the highest point on the vehicle body to ground.
- H111 ROCKER PANEL-REAR TO GROUND The dimension measured vertically from the bottom of the rocker or side-quarter panel at the front of the rear wheel opening, excluding flanges, to ground.
- H112 ROCKER PANEL-FRONT TO GROUND. The dimension measured vertically from the foremost point on the bottom of the rocker panels, excluding flanges, to ground
- H114 COWL POINT TO GROUND. Measured at zero "Y" plane.
- H121 BACKLIGHT SLOPE ANGLE. The angle between the vertical reference line and the surface of backlight at vehicle zero "Y" plane. For curve backlight, the angle is to chord of backlight arc from lower DLO to upper DLO
- H122 WINDSHIELD SLOPE ANGLE. The angle between the vertical reference line and a chord of the windshield arc running from the lower DLO to the upper DLO at the vehicle zero "Y" plane. In the case of wrap over glass, the angle to be measured will be formed by a chord 457 mm (18 0 in) long drawn from the lower DLO to the intersecting point on the windshield.
- H127 HEADLAMP TO GROUND-CURB MASS (WT.). The dimension measured vertically from the centerline of the lowest headlamp lens to ground.
- H128 TAILLAMP TO GROUND-CURB MASS (WT.). The dimension measured vertically from the centerline of the upper bulb to ground.
- H133 BOTTOM OF DOOR CLOSED-FRONT TO GROUND. The dimension measured vertically from the bottom outside corner of the door on the lock pillar side, in maximum closed position, to ground.
- H135 BOTTOM OF DOOR CLOSED-REAR TO GROUND. The dimension measured vertically from the bottom outside corner of the door on the lock pillar side, in maximum closed position, to ground.
- H138 DECK POINT TO GROUND. Measured at zero "Y" plane.
- H109 STATIC LOAD-TIRE RADIUS-REAR. Specified by the manufacturer in accordance with composite TIRE SECTION STANDARD.

Ground Clearance Dimensions

- H102 FRONT BUMPER TO GROUND. The minimum dimension measured vertically from the lowest point on the front bumper to ground, including bumper guards, if standard equipment
- H103 FRONT BUMPER TO GROUND-CURB MASS (WT.). Measured in the same manner as H102.

MVMA Specifications Form

Passenger Car

METRIC (U.S. Customary)

Interior Car And Body Dimensions – Key Sheet

Dimensions Definitions

- H104 REAR BUMPER TO GROUND. The minimum dimension measured vertically from the lowest point on the rear bumper to ground, including bumper guards, if standard equipment.
- H105 REAR BUMPER TO GROUND – CURB MASS (WT.). Measured in the same manner as H104.
- H106 ANGLE OF APPROACH. The angle measured between a line tangent to the front tire static loaded radius arc and the initial point of structural interference forward of the front tire to ground. The limiting structural component shall be designated.
- H107 ANGLE OF DEPARTURE. The angle measured between a line tangent to the rear tire static loaded radius arc and the initial point of structural interference rearward of the rear tire to ground. The limiting component shall be designated.
- H147 RAMP BREAKOVER ANGLE. The angle measured between two lines tangent to the front and rear tire static loaded radius and intersecting at a point on the underside of the vehicle which defines the largest ramp over which the vehicle can roll.
- H153 REAR AXLE DIFFERENTIAL TO GROUND. The minimum dimension measured from the rear axle differential to ground.
- H156 MINIMUM RUNNING GROUND CLEARANCE. The minimum dimension measured from the sprung vehicle to ground. Specify location.

Glass Areas

- S1 Windshield area.
- S2 Side windows area. Includes the front door, rear door, vents, and rear quarter windows on both sides of the vehicle.
- S3 Backlight areas.
- S4 Total area. Total of all areas (S1 + S2 + S3).

Fiducial Mark Dimensions

Fiducial Mark – Number 1

- L54 "X" coordinate.
- W21 "Y" coordinate.
- H81 "Z" coordinate.
- H161 Height "Z" coordinate to ground at curb weight
- H163 Height "Z" coordinate to ground.

Fiducial Mark – Number 2

- L55 "X" coordinate.
- W22 "Y" coordinate.
- W82 "Z" coordinate.
- H162 Height "Z" coordinate to ground at curb weight
- H164 Height "Z" coordinate to ground.

Front Compartment Dimensions

- L7 STEERING WHEEL TORSO CLEARANCE. The minimum dimension measured in the side view from the rearmost edge of the steering wheel, with front wheels in the straight ahead position, to the torso line.
- L11 ACCELERATOR HEEL POINT TO STEERING WHEEL CENTER. The dimension measured horizontally from the AHP to the intersection of the steering column centerline and a plane tangent to the upper surface of the steering wheel rim.
- L17 DESIGN H-POINT–FRONT TRAVEL. The dimension measured horizontally between the design H-point–front in the foremost and rearmost seat track positions. (See SAE J1100)
- L23 NORMAL DRIVING AND RIDING SEAT TRACK LEVEL. The dimension measured horizontally between a point on the design H-point travel line from the SgRP to the displaced point on the design H-point travel line with the seat moved to the foremost seat position, but not to include seat track travel used for purposes other than normal driving and riding positions. (See SAE J1100)
- L31 SgRP–FRONT. "X" COORDINATED.

- L34 MAXIMUM EFFECTIVE LEG ROOM–ACCELERATOR. The dimension measured along a line from the ankle pivot center to the SgRP–front plus 254 mm (10.0 in) measured with right foot on the undepressed accelerator pedal. For vehicles with SgRP to heel (H30) greater than 18 in., the accelerator pedal may be depressed as specified by the manufacturer. If the accelerator is depressed, the manufacturer shall place foot flat on pedal and note the depression of the pedal.
- L40 BACK ANGLE–FRONT. The angle measured between a vertical line through the SgRP–front and the torso line. If the seatback is adjustable, use the normal driving and riding position specified by the manufacturer.
- L42 HIP ANGLE–FRONT. The angle measured between torso line and thigh centerline.
- L44 KNEE ANGLE–FRONT. The angle measured between thigh centerline and lower leg centerline measured on the right leg.
- L46 FOOT ANGLE–FRONT. The angle measured between the lower leg centerline and a line tangent to the ball and heel of the bare foot flesh line measured on the right leg. Ref SAE J826.
- L53 SgRP–FRONT TO HEEL. The dimension measured horizontally from the SgRP–front to the accelerator heel point.
- W3 SHOULDER ROOM–FRONT. The minimum dimension measured laterally between the trimmed surfaces on the "X" plane through the SgRP–front at height between the belt line and 254 mm (10.0 in.) above the SgRP–front, excluding the door assist strap and attaching parts.
- W5 HIP ROOM–FRONT. The minimum dimension measured laterally between the trimmed surfaces on the "X" plane through the SgRP–front within 25 mm (1.0 in.) below and 76 mm (3.0 in.) above the SgRP–front and 76 mm (3.0 in.) fore and aft of the SgRP–front.
- W9 STEERING WHEEL MAXIMUM OUTSIDE DIAMETER. Define if other than round.
- H13 STEERING WHEEL TO CENTERLINE OF THIGH. The minimum dimension measured from the bottom of steering wheel, with front wheels in the straight position, to the thigh centerline.
- H17 ACCELERATOR HEEL POINT TO THE STEERING WHEEL CENTER. The dimension measured vertically from the AHP–front to the intersection of the steering column centerline to a plane tangent to the upper surface of the steering wheel rim.
- H18 STEERING WHEEL ANGLE. The angle measured from a vertical to the surface plane of the steering wheel.
- H30 SgRP–FRONT TO HEEL. The dimension measured vertically from the SgRP–front to the accelerator heel point.
- H37 HEADLINING TO ROOF PANEL–FRONT. The dimension measured from the intersection of the headlining and the extended effective head room line normal to the sheet metal.
- H50 UPPER BODY OPENING TO GROUND–FRONT. The dimension measured vertically from the trimmed body opening to the ground on the SgRP–front "X" plane.
- H61 EFFECTIVE HEAD ROOM–FRONT. The dimension measured along a line 8 deg. rear of vertical from the SgRP–front to the headlining plus 102 mm (4.0 in.).
- H67 FLOOR COVERING THICKNESS–UNDEPRESSED–FRONT. The dimension measured vertically from the surface of the undepressed floor covering to the underbody sheet metal at the accelerator heel point.
- PD1 PASSENGER DISTRIBUTION–FRONT.

Rear Compartment Dimensions

- L3 COMPARTMENT ROOM–SECOND. The dimension measured horizontally from the back of front seat to the front of the second seatback at a height tangent to the top of the second seat cushion.

MVMA Specifications Form

Passenger Car

METRIC (U.S. Customary)

Interior Car And Body Dimensions – Key Sheet

Dimensions Definitions

- L-41 BACK ANGLE-SECOND. The angle measured between a vertical line through the SgRP-second and the torso line.
- L43 HIP ANGLE-SECOND. The angle measured between torso line and thigh centerline.
- L45 KNEE ANGLE-SECOND. The angle measured between thigh centerline and lower leg centerline.
- L47 FOOT ANGLE-SECOND. The angle measured between the lower leg centerline and a line tangent to the ball and heel of the three-dimensional devices bare foot flesh line (Reference J826).
- L48 KNEE CLEARANCE-SECOND. The minimum dimension measured from the knee pivot center to the back of the front seatback minus 51 mm (2.0 in.).
- L50 SgRP COUPLE DISTANCE-SECOND. The dimension measured horizontally from the driver SgRP-front to the SgRP-second.
- L51 MINIMUM EFFECTIVE LEG ROOM-SECOND. The dimension measured along a line from the ankle pivot center to the SgRP-second plus 254mm (10.0 in.).
- W4 SHOULDER ROOM-SECOND. The minimum dimension measured laterally between door or quarter trimmed surfaces on the "X" plane through the SgRP-second at height between 254-406 mm (10.0-16.0 in.) above the SgRP-second, excluding the door assist straps and attaching parts.
- W6 HIP ROOM-SECOND. Measured in the same manner as W5.
- H31 SgRP-SECOND TO HEEL. The dimension measured vertically from the SgRP-second to the two dimensional device heel point on the depressed floor covering.
- H38 HEADLINING TO ROOF PANEL-SECOND. The dimension measured from the intersection of the headlining and the extended effective head room line normally to the roof sheet metal.
- H51 UPPER BODY OPENING TO GROUND-SECOND. The dimension measured vertically from the trimmed body opening to the ground on the "X" plane 330 mm (13.0 in.) forward of the SgRP-second.
- H63 EFFECTIVE HEAD ROOM-SECOND. The dimension measured along a line 8 deg rear of vertical from the SgRP to the headlining, plus 102 mm (4.0 in.).
- H73 FLOOR COVERING-DEPRESSED-SECOND. The dimension measured vertically from the heel point to the underbody sheet metal.
- PD2 PASSENGER DISTRIBUTION-SECOND

Luggage Compartment Dimensions

- V1 USABLE LUGGAGE CAPACITY-Total of volumes of individual pieces of standard luggage set plus H-boxes stowed in the luggage compartment in accordance with the procedure described in paragraph 8.2 of SAE-J1100a.
- H195 LIFTOVER HEIGHT. The dimension measured vertically from the luggage compartment lower opening at the zero "Y" plane to ground.

Interior Volumes (EPA Classification)

The Interior Volume Index is listed for each body style except two seaters. The interior volume index estimates the space in a car. It is based on four measurements – head room, shoulder room, hip room and leg room – for the front and rear seats, plus trunk capacity. The interior volume index is an estimate of the size of the passenger compartment.

The Trunk Cargo Index is an estimate of the size of the trunk cargo space. In station wagons and hatchbacks it is an estimate of the space behind the second seat.

Station Wagon – Third Seat Dimensions

- L85 SgRP COUPLE DISTANCE-THIRD. The dimension measured horizontally from the SgRP-second to the SgRP-third.
- L86 EFFECTIVE LEG ROOM-THIRD. The dimension measured along a line from the ankle pivot center to the SgRP-third plus 254 mm (10.0 in.).
- L87 KNEE CLEARANCE-THIRD. The minimum dimension from the knee pivot center to the back of second seatback minus a constant of 51mm (2.0 in.). With rear-facing third seat, dimension is measured to closure.
- L88 BACK ANGLE-THIRD. Measured in the same manner as L41.
- L89 HIP ANGLE-THIRD. Measured in the same manner as L43.
- L90 KNEE ANGLE-THIRD. Measured in the same manner as L45.
- L91 FOOT ANGLE-THIRD. Measured in the same manner as L47.
- W85 SHOULDER ROOM-THIRD. Measured in the same manner as W4.
- W86 HIP ROOM-THIRD. Measured in the same manner as W5.
- H86 EFFECTIVE HEAD ROOM-THIRD. The dimension, measured along a line 8 deg. from the SgRP-third to the headlining rear of vertical plus a constant of 102 mm (4.0 in.).
- H87 SgRP-THIRD TO HEEL POINT
- PD3 PASSENGER DIRECTION-THIRD.
- SD1 SEAT FACING DIRECTION-THIRD

Station Wagon – Cargo Space Dimensions

- L200 CARGO LENGTH-OPEN-FRONT. The minimum dimension measured longitudinally from the back of the front seatback at the height of the undepressed floor covering to the rearmost point on the undepressed floor covering on the open tailgate or cargo surface if the rear closure is a conventional door type tailgate at the zero "Y" plane.
- L201 CARGO LENGTH-OPEN-SECOND. The dimension measured longitudinally from the back of the second seatback at the height of the undepressed floor covering to the rearmost point on the undepressed floor covering on the open tailgate or cargo floor surface if the rear closure is a conventional door type tailgate, at the zero "Y" plane.
- L202 CARGO LENGTH-CLOSED-FRONT. The minimum dimension measured horizontally from the back of the front seat at the height of the undepressed floor covering to the rearmost point on the undepressed floor covering on the closed tailgate or taildoor for station wagons, trucks and mpv's at the zero "Y" plane.
- L203 CARGO LENGTH-CLOSED-SECOND. The dimension measured horizontally from the back of the second seat at the height of the undepressed floor covering to the rearmost point on the undepressed floor covering on the closed tailgate or taildoor for station wagons, trucks and mpv's at the zero "Y" plane.
- L204 CARGO LENGTH AT BELT-FRONT. The minimum dimension measured horizontally from the back of the front seatback at the seatback top to the foremost normal surface of the closed tailgate or inside surface of the cab backpanel at the height of the belt, on the zero "Y" plane.
- L205 CARGO LENGTH AT BELT-SECOND. The minimum dimension measured horizontally from the back of the second seatback at the seatback top to the foremost normal surface of the closed tailgate at the height of the belt, on the zero "Y" plane.
- W201 CARGO WIDTH-WHEELHOUSE. The minimum dimension measured laterally between the trimmed wheelhouseings at floor level. For any vehicle not trimmed, measure to the sheet metal.

MVMA Specifications Form Passenger Car

METRIC (U.S. Customary)

Interior Car And Body Dimensions – Key Sheet Dimensions Definitions

- W203 REAR OPENING WIDTH AT FLOOR.** The minimum dimension measured laterally between the limiting interferences of the rear opening at floor level.
- W204 REAR OPENING WIDTH AT BELT.** The minimum dimension measured laterally between the limiting interferences of the rear opening at belt height or top of pick up box.
- W205 REAR OPENING WIDTH ABOVE BELT.** The minimum dimension measured laterally between the limiting interferences of the rear opening above the belt height.
- H197 FRONT SEATBACK TO LOAD FLOOR HEIGHT.** The dimension measured vertically from the horizontal tangent to the top of the seatback to the undepressed floor covering
- H201 CARGO HEIGHT.** The dimension measured vertically from the top of the undepressed floor covering to the headlining at the rear wheel "X" coordinate on the zero "Y" plane.
- H202 REAR OPENING HEIGHT.** The dimension measured vertically from the top of the undepressed floor covering to the upper trimmed opening on the zero "Y" plane with rear door fully open.
- H250 TAILGATE TO GROUND CURB MASS (WT.).** The dimension measured vertically from the top of the undepressed floor covering on the lowered tailgate to ground on the zero "Y" plane.
- V2 STATION WAGON**
Measured in inches:

$$\frac{W4 \times H201 \times L204}{1728} = \text{ft}^3$$
 Measured in mm:

$$\frac{W4 \times H201 \times L204}{10^9} = \text{m}^3 \text{ (cubic meter)}$$
- V4 HIDDEN LUGGAGE CAPACITY-REAR OF FRONT SEAT.** The total volumes of individual pieces of one set of standard luggage stowed in any hidden cargo area below the load floor rear of the front seat.
- V5 TRUCKS AND MPV'S WITH OPEN AREA.**
Measured in inches:

$$\frac{L506 \times W500 \times H503}{1728} = \text{ft}^3$$
 Measured in mm:

$$\frac{L506 \times W500 \times H503}{10^9} = \text{m}^3 \text{ (cubic meter)}$$
- V6 TRUCKS AND MPV'S WITH CLOSED AREA.**
Measured in inches:

$$\frac{L204 \times W500 \times H505}{1728} = \text{ft}^3$$
 Measured in mm:

$$\frac{L204 \times W500 \times H505}{10^9} = \text{m}^3 \text{ (cubic meter)}$$
- V8 HIDDEN LUGGAGE CAPACITY-REAR OF SECOND SEAT.** The total volume of individual pieces of one set of standard luggage stowed in any hidden cargo area below the load floor rear of the second seat.
- V10 STATION WAGON CARGO VOLUME INDEX.**
Measured in inches:

$$\frac{H201 \times L205 \times \frac{W4 + W201}{2}}{1728} = \text{ft}^3$$
 Measured in mm:

$$\frac{H201 \times L205 \times \frac{W4 + W201}{2}}{10^9} = \text{m}^3 \text{ (cubic meter)}$$

Hatchback – Cargo Space Dimensions

All hatchback cargo dimensions are to be taken with the front seat in full down and rear position, and the rear seat folded down. The hatchback door is in the closed position. (For electrically adjusted seats, see the manufacturer's specifications for Design "H" Point).

- L208 CARGO LENGTH AT FRONT SEATBACK HEIGHT.** The minimum horizontal dimension from the "X" plane tangent to the rearmost surface of the driver's seatback to the inside limiting interference of the hatchback door on the vehicle zero "Y" plane.
- L209 CARGO LENGTH AT FLOOR-FRONT-HATCHBACK.** The minimum horizontal dimension measured at floor level from the rear of the front seatback to the normal limiting interference of the hatchback door on the vehicle zero "Y" plane.
- L210 CARGO LENGTH AT SECOND SEATBACK HEIGHT-HATCHBACK.** The minimum dimension measured from the "X" plane tangent to the rearmost surface of second seatback or the load floor which is stowed at least one half of the H198 dimension height above the rear load floor, to the rearmost inside limiting interference on the zero "Y" plane.
- L211 CARGO LENGTH AT FLOOR-SECOND HATCHBACK.** The minimum horizontal dimension measured at floor level from the rear of the second seatback or load floor panel to the normal limiting interference of the hatchback door on the vehicle zero "Y" plane.
- H197 FRONT SEATBACK TO LOAD HEIGHT.** The dimension measured vertically from the horizontal tangent to the top of the seatback to the undepressed floor covering.
- H198 SECOND SEATBACK TO LOAD FLOOR HEIGHT:** The dimension measured vertically from the second seat back to the undepressed floor covering.
- V3 HATCHBACK.**
Measured in inches:

$$\frac{\frac{L208 + L209}{2} \times W4 \times H197}{1728} = \text{ft}^3$$
 Measured in mm:

$$\frac{\frac{L208 + L209}{2} \times W4 \times H197}{10^9} = \text{m}^3 \text{ (cubic meter)}$$
- V4 HIDDEN LUGGAGE CAPACITY-REAR OF FRONT SEAT.** The total volumes of individual pieces of one set of standard luggage stowed in any hidden cargo area below the load floor rear of the front seat.
- V11 HATCHBACK CARGO VOLUME INDEX.** Usable luggage (one (1) stand and luggage set) below floor:
Measured in inches:

$$\frac{\frac{L210 + L211}{2} \times W4 \times H198}{1728} = \text{ft}^3$$
 Measured in mm:

$$\frac{\frac{L210 + L211}{2} \times W4 \times H198}{10^9} = \text{m}^3 \text{ (cubic meter)}$$

MVMA Specifications Form

Passenger Car

METRIC (U.S. Customary)

Index

Subject	Page No.	Subject	Page No.
Aerodynamics	22	Lamps and Headlamp Shape	24
Alternator	16	Legroom	21, 22
Automatic Transmission/Transaxle	8, 9	Lengths - Car and Body	20
Axis, Steering	14	Leveling, Suspension	11
Axle, Drive, Front, Rear	2, 9, 10	Lifters, Valve	4
Axle Shafts	10	Linings - Clutch, Brake	8, 12
Battery	16	Lubrication - Engine Transmission/Transaxle	4, 8, 9
Body and Miscellaneous Information	17	Luggage Compartment	21
Brakes - Parking, Service	12, 13	Mass	25, 26
Camber	15	Models	1
Camshaft	3	Motor Starting	16
Capacities		Muffler	7
Cooling System	5	Passenger Capacity	1
Fuel Tank	6	Passenger Mass Distribution	25
Lubricants		Pistons	3
Engine Crankcase	4	Power Brakes	12
Transmission Transaxle	8, 9	Power, Engine	2
Rear Axle	10	Power Steering	14
Car Models	1	Power Teams	2
Car and Body Dimensions		Propeller Shaft Universal Joints	10
Width	20	Pumps - Fuel	6
Length	20	Water	5
Height	20	Radiator - Cap, Hoses, Core	5
Ground Clearance	20	Ratios - Axle, Transaxle	2, 9
Front Compartment	21	Compression	2
Rear Compartment	21	Steering	14
Luggage Compartment	21	Transmission/Transaxle	2, 8, 9
Station Wagon - Third Seat	22	Rear Axle	2, 9, 10
Station Wagon - Cargo Space	22	Regulator - Alternator	16
Hatchback - Cargo Space	22	Restraint System	18
Carburetor	2, 6	Rims	13
Caster	15	Rods - Connecting	4
Choke, Automatic	6	Scrub Radius	14
Clutch - Pedal Operated	8	Seats	17
Coil, Ignition	16	Shock Absorbers, Front & Rear	11
Connecting Rods	4	Spark Plugs	16
Convenience Equipment	19	Speedometer	15
Cooling System	5	Springs - Front & Rear Suspension	11
Crankshaft	4	Stabilizer (Sway Bar) - Front & Rear	11
Cylinders and Cylinder Head	3	Starting System	16
Diesel Information	4	Steering	14
Dimension Definitions		Suppression - Ignition, Radio	16
Key Sheet - Exterior	27, 30, 31	Suspension - Front & Rear	11
Key Sheet - Interior	28, 29, 31, 32, 33	Tail Pipe	7
Electrical System	15, 16	Theft Protection	19
Emission Controls	7	Thermostat, Cooling	5
Engine - General		Tires	13
Bore, Stroke, Type	3	Toe-In	15
Compression Ratio	2	Torque Converter	9
Displacement	2, 3	Torque - Engine	2, 8, 9
Firing Order, Cylinder Numbering	3	Transaxle	9
General Information, Power & Torque	2	Transmission - Types	2, 8, 9
Intake System	4	Transmission - Automatic	2, 8, 9
Power Teams	2	Transmission - Manual	2, 8, 9
Exhaust System	7	Transmission - Ratios	2, 9
Equipment Availability, Convenience	19	Tread	20
Fan, Cooling	5	Trunk Cargo Load	1
Fiducial Marks	23	Trunk Luggage Capacity	21
Filters - Engine Oil, Fuel System	4	Turning Diameter	14
Frame	17	Unitized Construction	17
Front Suspension	11	Universal Joints, Propeller Shaft	10
Front Wheel Drive Unit	10	Valve System	4
Fuel System	6	Voltage Regulator	16
Fuel Injection	6	Water Pump	5
Fuel Tank	6	Weights	25, 26
Glass	18	Wheel Alignment	15
Headroom - Body	21, 22	Wheelbase	20
Heights - Car and Body	20	Wheels & Tires	13
Horns	15	Wheel Spindle	14
Horsepower - Brake	2	Widths - Car and Body	20
Ignition System	16	Windshield	18
Inflation - Tires	13	Windshield Wiper and Washer	15
Interior Volumes	21		
Instruments	15		

**MVMA Specifications Form
Passenger Car**

**METRIC (U.S. Customary)
SUPPLEMENTAL PAGE**

Car Line _____
Model Year _____ Issued _____ Revised (•) _____