





CORVETTE

1987

SPECIFICATIONS

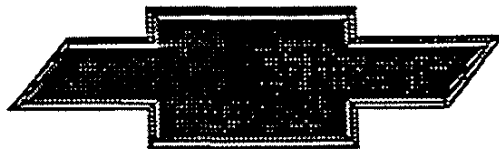
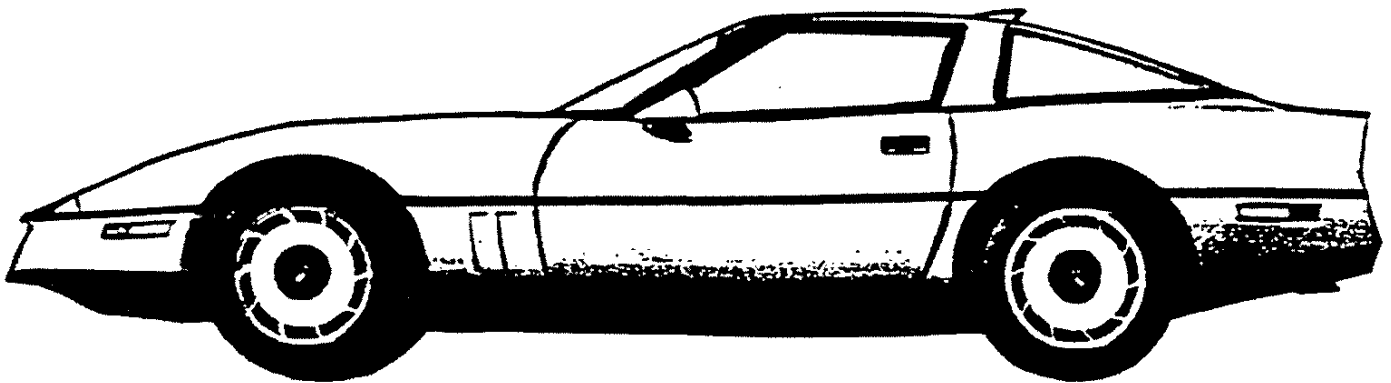

GENUINE CHEVROLET

10

1987 CORVETTE

Production: 20,007 coupe, 10,625 convertible, 30,632 total

1987 NUMBERS

Vehicle: 1G1YY2182H5100001 thru 1G1YY2182H5130632

- For convertibles, sixth digit is a 3.
- Ninth digit is a check code and varies.

Suffix: ZJN: 350ci, 240hp, at ZLA: 350ci, 240hp, at, oc
ZLC: 350ci, 240hp, mt, oc ZLB: Export

- For Callaway twin-turbo, Chevrolet engine coding was replaced as follows: First two digits for year, next three digits for Callaway sequence, last four digits to match last four digits of vehicle identification number.

Block: 14093638: All

Head: 14101128: All

Abbreviations: at=automatic transmission, ci=cubic inch, hp=horsepower, mt=manual transmission, oc=engine oil cooler.

1987 FACTS

- Friction reduction from roller valve lifters (new for 1987) resulted in a power increase to 240hp, up 5hp from 1986's aluminum-head engines.
- Center sections and radial slots of 1987 wheels were painted argent gray. 1986 wheel centers were not painted. Centers and radial slots for 1984 and 1985 were painted black.
- Convertibles and early coupes had outside mirror air deflectors.
- Chevrolet planned an RPO UJ6 low tire pressure indicator option, but the \$325 option was on constraint during 1987 due to false signalling problems. However, Chevrolet records show forty-six units sold.
- The RPO Z51 package was refined to include structural enhancements developed for the convertible, and a finned power steering fluid cooler.
- A new RPO Z52 "sport" handling package combined elements of Z51 with the softer suspension of base models. RPO Z52 included the radiator boost fan, Bilstein shock absorbers, engine oil cooler, heavy-duty radiator, 16x9.5-inch wheels, faster 13:1 steering ratio, larger front stabilizer bar (except early production), and the convertible-inspired structural improvements for coupes. Z52 was available with coupes or convertibles, automatic or manual transmissions.
- The overdrive-engage light was moved from the center-dash area (1984-86) to an easier-to-view location within the 1987 tach display.
- The Callaway Twin-Turbo engine package introduced in 1987 was not a factory-installed option, but could be ordered through participating Chevrolet dealers as RPO B2K. Fully assembled Corvettes were shipped from the Bowling Green Corvette plant to Callaway Engineering in Old Lyme, Connecticut, for engine and other modifications. The 1987 Callaway had ratings of 345hp and 465 lb.-ft torque, and reached a top speed of 177.9 mph with .60 overdrive gearing. The first four 1987 Callaways used replacement LF5 (truck) shortblocks, but subsequent cars had reworked production Corvette engines. All 1987 Callaways had manual transmissions and none were certified for California sale. Of 184 twin-turbos built in 1987, 121 were coupes, 63 were convertibles.
- Electronic air conditioning control (RPO C68) became an available option for coupes and convertibles in 1987; in 1986, it was coupe-only.
- New 1987 convenience options included an illuminated vanity mirror (D74) for the driver's visor, and a passenger-side power seat base (AC1). Twin remote heated mirrors became available for convertibles as RPO DLB. The heated mirrors were included with the heated rear window in the RPO Z6A defogger option for coupes.



1987 OPTIONS

RPO #	DESCRIPTION	QTY	RETAIL \$
1YY07	Base Corvette Sport Coupe	20,007	\$27,999.00
1YY67	Base Corvette Convertible	10,625	33,172.00
AC1	Power Passenger Seat	17,124	240.00
AC3	Power Driver Seat	29,561	240.00
AQ9	Sport Seats, leather	14,119	1,025.00
AR9	Base Seats, leather	14,579	400.00
AU3	Power Door Locks	29,748	190.00
B2K	Callaway Twin Turbo (not GM installed)	184	19,995.00
B4P	Radiator Boost Fan	7,291	75.00
C2L	Dual Removable Roof Panels (coupe)	5,017	915.00
24S	Removable Roof Panel, blue tint (coupe)	8,883	615.00
64S	Removable Roof Panel, bronze tint (coupe)	5,766	615.00
C68	Electronic Air Conditioning Control	20,875	150.00
DL8	Twin Remote Heated Mirrors (convertible)	6,840	35.00
D74	Illuminated Driver Vanity Mirror	14,992	58.00
D84	Two-Tone Paint (for coupe)	1,361	428.00
FG3	Delco-Bilstein Shock Absorbers	1,957	189.00
G92	Performance Axle Ratio, 3.07:1	7,285	22.00
KC4	Engine Oil Cooler	6,679	110.00
K34	Cruise Control	29,594	185.00
MM4	4-Speed Manual Transmission	4,229	0.00
NN5	California Emission Requirements	5,423	99.00
UL5	Radio Delete	247	-256.00
UM6	AM-FM Stereo Cassette	2,182	132.00
UU8	Stereo System, Delco-Bose	27,721	905.00
V01	Heavy-Duty Radiator	7,871	40.00
Z51	Performance Handling Package (coupe)	1,596	795.00
Z52	Sport Handling Package	12,662	470.00
Z6A	Rear Window+Side Mirror Defog (coupe)	19,043	165.00

• A 350ci, 240hp engine, 4-speed automatic transmission, removable body-color roof panel (coupe) or soft top (convertible), and cloth seats were included in the base price.

• RPO Z51 included B4P, FG3, KC4, V01, 16x9.5-inch wheels, heavy-duty suspension, fast steering ratio. Coupes and manual transmissions only.

• RPO B2K generated a specific equipment build with standard engines at the Corvette assembly plant. The cars were then sent to Callaway's Connecticut shop for installation of Callaway-modified twin-turbo engines.

1987 COLORS

CODE	EXTERIOR	QTY	SOFT TOP	INTERIORS
13	Silver Metallic	767	Bk-W	Gr-Mg
18	Medium Gray Metallic	1,035	Bk-W	Gr-Mg-R
20	Medium Blue Metallic	2,677	Bk-W	B-Gr
35	Yellow	1,051	Bk-W	Gr
40	White	3,097	Bk-S-W	B-Br-Gr-Mg-R-S
41	Black	5,101	Bk-S-W	Gr-Mg-R-S
53	Gold Metallic	397	Bk-S	Gr-S
59	Silver Beige Metallic	950	Bk	Br-Gr
66	Copper Metallic	87	Bk-S	Gr-S
69	Medium Brown Metallic	245	S	Br-S
74	Dark Red Metallic	5,578	Bk-S-W	Gr-S
81	Bright Red	8,285	Bk-S-W	Gr-R-S
13/18	Silver/Gray	403	none	Gr-Mg-R
18/41	Gray/Black	316	none	Gr-Mg
40/13	White/Silver	195	none	Gr-Mg
59/69	Silver Beige/Medium Brown	447	none	Br

• Suggested interiors shown. Other combinations were possible.

• Restrictions applied to some soft top and interior color combinations.

Interior Codes: 12C=Gr/C, 122=Gr/L, 15C=Mg/C, 152=Mg/L, 21C=B/C, 212=B/L, 62C=S/C, 622=S/L, 65C=Br/C, 652=Br/L, 732=R/L.

Abbreviations: B=Blue, Bk=Black, Br=Bronze, C=Cloth, Gr=Graphite, L=Leather, Mg=Medium Gray, R=Red, S=Saddle, W=White.



•
•



ALPHABETICAL OPTION INDEX

(Not for ordering purposes)

Option Number	Description	Option Number	Description
AC1	SEAT, POWER: Six-Way, Passenger	NN5	EMISSION SYSTEM: California Emission Requirements
AC3	SEAT, POWER: Six-Way, Driver	UJ6	TIRE PRESSURE INDICATOR, LOW
AU3	DOOR LOCK SYSTEM, POWER	UL5	RADIO EQUIPMENT: Radio Delete
B3W	PRELIMINARY PRICE INFORMATION	UM6	RADIO EQUIPMENT: Electronically Tuned AM/FM Stereo Radio w/Seek-Scan and Cassette Tape and Digital Clock
B4P	FAN, RADIATOR COOLING BOOST	UU8	RADIO EQUIPMENT: Delco-Bose Music System-Electronically Tuned AM/FM Stereo Radio w/Seek-Scan and Cassette Tape and Digital Clock
C2L	ROOF PACKAGE, DUAL REMOVABLE	V01	RADIATOR, HEAVY-DUTY
C68	AIR CONDITIONING: Electronic Control	Z51	PERFORMANCE HANDLING PACKAGE
DL8	MIRRORS: Twin Remote	Z52	SPORT HANDLING PACKAGE
D60	NON-RECOMMENDED COLOR COMBINATION	Z6A	DEFOGGER SYSTEM: Rear Window and Outside Rearview Mirrors
D74	MIRROR: Vanity, Illuminated, Driver	11T	CONVERTIBLE TOP: White
D84	PAINT, CUSTOM TWO-TONE	19T	CONVERTIBLE TOP: Black
FG3	SHOCK ABSORBERS: Delco/Bilstein	67T	CONVERTIBLE TOP: Saddle
G92	AXLE, REAR: Performance Ratio	24S	ROOF PANEL: Transparent Removable, Blue Tint
KC4	COOLER, ENGINE OIL	64S	ROOF PANEL: Transparent Removable, Bronze Tint
K34	SPEED CONTROL, ELECTRONIC: With Resume Speed		
L98	ENGINE: 5.7 Liter T.P.I. V8		
MM4	TRANSMISSION: 4-Speed Manual with Overdrive		
MX0	TRANSMISSION WITH OVERDRIVE: Automatic		
NA5	EMISSION SYSTEM: Standard Emission Equipment		

B2K Callaway Corvette
 - see Callaway info in Hobby Tech

CORVETTE

COLOR AND TRIM SELECTION

PLEASE NOTE: The Exterior and Interior Combinations shown in the charts below and designated as recommended (R), represent the ideal combinations. Those that are shown as acceptable (A), are attractive, but less desirable than the recommended combinations.

Interior Trim Color		Blue	Bronze	Graphite	Gray	Red	Saddle
MODEL	SEAT TYPE						
1YY07	Leather Bucket	ADD2	AEE2	A882	AQQ2	ARR2	AUU2
	Leather Adjustable Sport Bucket	ADD8	AEE8	A888	AQQ8	ARR8	AUU8
	Cloth Bucket	HDD2	HEE2	H882	HQQ2		HUU2

CUSTOM TWO-TONE PAINT (D64 Must be Specified in "Plus" (+) Option Section of Order Worksheet) (D60 NON-RECOMMENDED COLOR COMBINATION NOT PERMITTED)

Exterior Paint Color	Color Code 1	Color Code 2	Blue	Bronze	Graphite	Gray	Red	Saddle
Gray, Med (Met) & Black	18	41			R	R		
Silver (Met) & Med Gray (Met)	13	18			R	R	A	
Silver Beige (Met) & Med Brown (Met)	59	69		R				
White & Silver (Met)	40	13			A	R		

SOLID PAINT APPLICATION

PLEASE NOTE: Orders for additional Interior Trim combinations may be submitted, provided the dealer orders (D60), as verification that the requested combination is definitely desired.

Exterior Paint Color	Color Code 1	Color Code 2	Blue	Bronze	Graphite	Gray	Red	Saddle
Black	41	41			R	R	R	R
Blue, Corvette Med (Met)	20	20	R		R			
Brown, Corvette Med (Met)	69	69		R				R
Copper, Corvette (Met)	66	66			R			R
Gold, Corvette (Met)	53	53			A			R
Gray, Corvette Med (Met)	18	18			R	R	R	
Red, Corvette Bright	81	81			R		R	R
Red, Corvette Dk (Met)	74	74			A			R
Silver, Corvette (Met)	13	13			R	R	R	
Silver Beige, Corvette (Met)	59	59		R	A			
White, Corvette	40	40	A	A	R	R	R	R
Yellow, Corvette	35	35			R			A

POWER TEAMS (Refer to next page for option availability and application)

ENGINE OPTION CONDITION	AXLE RATIO	
	2.59	3.07
WITH NA5 STANDARD EMISSIONS		
L98 MX0	Std	G92
MM4	—	Std
WITH NN5 CALIFORNIA EMISSIONS		
L98 MX0	Std	G92
MM4	—	Std

CORVETTE

REFER WEEKLY STOPS/LATEST UPDATE

MODEL
1YY07 Corvette 2-Door Hatchback Coupe

ENGINE: MUST ORDER (See Power Teams)

STANDARD EMISSION EQUIPMENT—REQUIRES NAS (Also Satisfies High Altitude Requirements)
_____ L98 5.7 Liter T.P.I. V8

CALIFORNIA EMISSION EQUIPMENT—REQUIRES NNS
_____ L98 5.7 Liter T.P.I. V8

EMISSION SYSTEMS: MUST ORDER ONE (See Above)

_____ NAS STANDARD EMISSION EQUIPMENT
_____ NNS CALIFORNIA EMISSION REQUIREMENTS

QUICK-SPEC

IF TRANSMISSION
IN QUICK-SPEC IS NOT DESIRED
YOU MUST "PLUS" ANOTHER
TRANSMISSION OPTION.

Defogger System	Z6A	x	C
Door Lock System, Power	AU3	x	V
Preliminary Price Information	B3W	x	A
Radio, AM/FM Stereo w/Cassette Tape and Digital Clock (Delco/Bose Sound System)	UU8	x	1
Seat, Power, Driver	AC3	x	
Speed Control with Resume Speed	K34	x	
Transmission, Automatic w/Overdrive	MX0	x	

PLEASE REVIEW OPTION RESTRICTIONS BEFORE ORDERING

Q.S.	OPTION
—	C68 AIR CONDITIONING: Electronic Control
—	G92 AXLE, REAR: Performance Ratio (Refer: Power Teams Chart)
—	KC4 COOLER, ENGINE OIL: (Incl w/Z51 and Z52 Handling Packages)
(1)	Z6A DEFOGGER SYSTEM: Rear Window and Outside Rearview Mirrors
(1)	AU3 DOOR LOCK SYSTEM, POWER
—	B4P FAN, RADIATOR COOLING BOOST: (Incl w/Z51 and Z52 Handling Packages)
—	D74 MIRROR: Visor, Illuminated, Driver
—	D84 PAINT, CUSTOM TWO-TONE: (Refer Page 2 for Exterior Paint Availability)
—	Z51 PERFORMANCE HANDLING PACKAGE: (Reqs MM4 Trans) (Incls Special Suspension, FG3 Shock Absorbers, KC4 Eng Oil Cooler, B4P Radiator Fan, V01 H.D. Radiator and 9 1/2" Wheels) (N/A G92 Axle)
—	Z52 SPORT HANDLING PACKAGE: (Incls FG3 Shock Absorbers, KC4 Eng Oil Cooler, B4P Radiator Fan, V01 H.D. Radiator and 9 1/2" Wheels) (N/A Z51 Performance Hndlg Pkg)
(1)	B3W PRELIMINARY PRICE INFORMATION
—	V01 RADIATOR, HEAVY-DUTY: (Incl w/Z51 and Z52 Handling Packages)
—	RADIO EQUIPMENT:
—	UM6 — Electronically Tuned AM/FM Stereo Radio w/Seek-Scan and Cassette Tape and Digital Clock
(1)	UU8 — Delco/Bose Music System—Electronically Tuned AM/FM Stereo Radio w/Seek-Scan and Cassette Tape and Digital Clock
—	UL5 — Radio Delete
—	ROOF PANELS: (Lift-Off)
—	24S — Blue Tint, Transparent (Replaces Std Solid Panel)
—	64S — Bronze Tint, Transparent (Replaces Std Solid Panel)
—	C2L — Roof Package (Incls Std Solid Panel and Transparent Panel) (Reqs 24S or 64S Panel)
—	SEATS, POWER:
—	AC1 — Six-Way, Passenger (Reqs AC3 Power Seat)
(1)	AC3 — Six-Way, Driver
—	FG3 SHOCK ABSORBERS: Delco/Bilstein (Incl w/Z51 and Z52 Handling Packages)
(1)	K34 SPEED CONTROL, ELECTRONIC: With Resume Speed
—	U3C TIRE PRESSURE INDICATOR, LOW
—	TRANSMISSIONS: (See Power Teams Chart)
—	MM4 — 4-Speed Manual with Overdrive (Reqs B4P Radiator Fan, KC4 Eng Oil Cooler and V01 H.D. Radiator)
(1)	MX0 — Automatic Transmission with Overdrive

CORVETTE CONVERTIBLE

COLOR AND TRIM SELECTION

PLEASE NOTE: The Exterior Paint and Interior Trim Combinations shown below are the only combinations that are available. (D60 Non-Recommended Color Combination Not Permitted)

Interior Trim Color	Blue	Bronze	Graphite	Gray	Red	Saddle	
MODEL	SEAT TYPE						
1YY67	Leather Bucket	ADD2	AEE2	ABB2	AQQ2	ARR2	AUU2
	Leather Adjustable Sport Bucket	ADD8	AEE8	ABB8	AQQ8	ARR8	AUU8
	Cloth Bucket	HDD2	HEE2	HBB2	HQQ2		HUU2

✓ @ CONVERTIBLE TOP SELECTOR

Exterior Paint Color	Color Code 1	Color Code 2	Blue	Bronze	Graphite	Gray	Red	Saddle
Black	41	41			11T/19T	11T/19T	19T	19T/67T
Blue, Corvette Med (Met)	20	20	11T/19T		19T			67T
Brown, Corvette Med (Met)	69	69		67T				67T
Copper, Corvette (Met)	66	66			19T			19T/67T
Gold, Corvette (Met)	53	53			19T			19T/67T
Gray, Corvette Med (Met)	18	18			11T/19T	11T/19T	11T/19T	
Red, Corvette Bright	81	81			11T/19T		11T/19T/67T	67T
Red, Corvette Dk (Met)	74	74			11T/19T			67T
Silver, Corvette (Met)	13	13			11T/19T	11T/19T	11T/19T	
Silver Beige, Corvette (Met)	59	59			19T			
White, Corvette	40	40	11T	11T	11T/19T	11T/19T	11T	11T/67T
Yellow, Corvette	35	35			11T/19T			19T

@ Convertible Top Option Must Be Specified in "Plus" (+) Option Section of Order Worksheet.

CONVERTIBLE TOP COLORS

WHITE 11T BLACK 19T
 SADDLE 67T

POWER TEAMS (Refer to next page for option availability and application)

ENGINE OPTION CONDITION	AXLE RATIO	
	2.73	3.07
WITH NAS STANDARD EMISSIONS		
L98 MX0	Std	G92
MM4	—	Std
WITH NINE CALIFORNIA EMISSIONS		
L98 MX0	Std	G92
MM4	—	Std

CORVETTE CONVERTIBLE

REFER WEEKLY STOPS/LATEST UPDATE

MODEL
1YY67 Corvette 2-Door Convertible

ENGINE: MUST ORDER (See Power Teams)

STANDARD EMISSION EQUIPMENT—REQUIRES NA5 (Also Satisfies High Altitude Requirements)
L98 5.7 Liter T.P.I V8

CALIFORNIA EMISSION EQUIPMENT—REQUIRES NNS
L98 5.7 Liter T.P.I V8

EMISSION SYSTEMS: MUST ORDER ONE (See Above)

NA5 STANDARD EMISSION EQUIPMENT
NNS CALIFORNIA EMISSION REQUIREMENTS

QUICK-SPEC

IF TRANSMISSION
IN QUICK-SPEC IS NOT DESIRED
YOU MUST "PLUS" ANOTHER
TRANSMISSION OPTION.

	C	Y	A	1
Door Lock System, Power			AU3	x
Preliminary Price Information			B3W	x
Radio, AM/FM Stereo w/Cassette Tape and Digital Clock (Delco/Bose Sound System)			UU8	x
Seat, Power, Driver			AC3	x
Speed Control with Resume Speed			K34	x
Transmission, Automatic w/Overdrive			MX0	x

PLEASE REVIEW OPTION RESTRICTIONS BEFORE ORDERING

Q-S	OPTION
—	C68 AIR CONDITIONING: Electronic Control
—	G92 AXLE, REAR: Performance Ratio (Refer Power Teams Chart) (N/A UU8 Radio)
(1)	KC4 COOLER, ENGINE OIL
—	AU3 DOOR LOCK SYSTEM, POWER
—	B4P FAN, RADIATOR COOLING BOOST
—	DL8 MIRRORS: Twin Remote Heated
—	D74 MIRROR: Vanity, Illuminated, Driver
(1)	53W PRELIMINARY PRICE INFORMATION
—	V01 RADIATOR, HEAVY-DUTY
—	RADIO EQUIPMENT:
—	UM6 Electronically Tuned AM/FM Stereo Radio w/Seek-Scan and Cassette Tape and Digital Clock
(1)	UU8 Delco/Bose Music System—Electronically Tuned AM/FM Stereo Radio w/Seek-Scan and Cassette Tape and Digital Clock
—	UL5 Radio Delete
—	SEAT, POWER:
—	AC1 Six-Way, Passenger (Reqs AC3 Power Seat)
(1)	AC3 Six-Way, Driver
(1)	K34 SPEED CONTROL ELECTRONIC: With Resume Speed
—	UJ6 TIRE PRESSURE INDICATOR, LOW
✓	MM4 TRANSMISSIONS: (See Power Teams Chart) 4-Speed Manual with Overdrive (Reqs B4P Radiator Fan, KC4 Eng Oil Cooler and V01 H.D. Radiator)
(1)	MX0 Automatic Transmission with Overdrive

252 Sport Steering Pkg (Incl F63, KC4 B4P and V01)
F63 Shock Absorbers (Delco/Ribstein) (Incl 4/252)



2

.

.



**CORVETTE.
A LEGEND
IN ITS OWN TIME.**



It all began as a dream, born in the minds of engineers who watched racing machines and the men who drove them. This was the dream that became a challenge... a commitment... then a car. A car with all the attributes designed to please the most demanding drivers.

A car that has evolved precisely through the years. A car that has taken on Europe's best and beaten them at their own game. Corvette is truly America's own sports car.

IMPORTANT FACTS FOR BUYERS

- This is one of the most completely equipped cars sold in America ■ Now with Bosch ABS II Anti-Lock Braking System that aids steering during braking on wet or slippery surfaces ■ Vehicle Anti-Theft System (VATS) uses specially encoded keys, causing delays of 15-20 minutes to discourage even resourceful thieves ■ Choice of 4-speed manual transmission with automatic overdrive in three top gears to give, in effect, a 7-speed transmission, or a 4-speed automatic with torque converter clutch in three top gears for highway cruising ■ Heavy-duty 8 1/2" ring gear with 4-speed manual transmission ■ 16" cast alloy road wheels with Goodyear VR50 unidirectional tires ■ Forged aluminum front and rear suspension arms with fiberglass composite leaf springs. ■ New Z52 Sport Handling Package available.

CORVETTE	MODEL NO.	PASSENGER CAPACITY	
Hatchback Coupe	1YY07	All Models	2
Convertible	1YY67		

INDEX

Model Features	2-5	Equipment Summary	12-13	Color & Trim Selections Chart	16
Corvette Hatchback Coupe	6	Body Features	14	Seat & Door Trim Styling	16
Corvette Convertible	7	Power Teams & Engine Specifications	15	Exterior Colors	17
Interior Features	8	Dimensions, Specifications & Service Intervals	15	Interiors Colors	18
Instrument Panel Features	9			Exterior Decor Features	19
Optional Features	10-11				

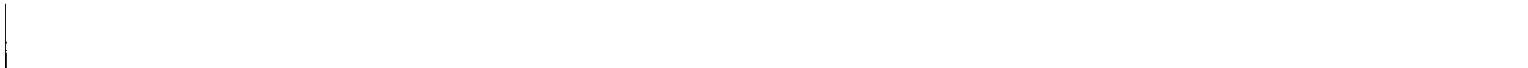

1987 CORVETTE



CORVETTE	Model Number
Coupe	1YY07
Convertible	1YY67

NEW FEATURES

- Roller valve lifters added to standard 5.7 Liter TPI V8 engine reduce friction and improve drivability.
- Optional Low Tire Pressure Indicator system alerts driver to tire air pressure changes by instrument panel warning light.
- Passenger seat 6-way power adjuster now available.
- Overdrive engaged ("OD") telltale light now located below tach curve on instrument display.
- Driver's side lighted vanity mirror is a new option.
- Generator low-output telltale moves to center console driver information module.
- Key components carry identification for theft deterrence.
- Sport Handling Package (RPO Z52) available for Coupe.

STANDARD FEATURES

- Uniframe-design body structure with corrosion-resistant coating
- Clamshell-opening front end assembly for easy engine access.
- Bosch ABS II anti-lock braking system.
- Full-glass rear hatch with three remote releases and roller-shade cargo cover (Coupe).
- One-piece removable fiberglass roof panel. (Coupe)
- Full folding roof for Convertible.
- Independent front and rear suspension with fiberglass transverse leaf springs and forged aluminum A-arms.
- Ultra-contemporary instrument panel features electronic liquid-crystal instrumentation with multi-colored analog and digital display in either English or metric readout.
- Driver information system with instant MPG, average MPG and range readouts.
- Electronically tuned, Seek & Scan AM/FM stereo with digital clock and 4-speaker system*
- Side-window defoggers, halogen fog lamps and rear side lamps.
- Power-adjusted outside rearview mirrors.

- Automatic power-operated radio antenna.
- Cloth seats with lateral support and back-angle adjustments plus wool-pad comfort liner.
- Cast alloy 16" x 8½" (16" x 9½" on Convertible) aluminum wheels and Goodyear Eagle VR50 steel-belted radial tires.
- Power rack-and-pinion steering and power four-wheel disc brakes.
- Air conditioning and power windows.
- Anti-theft system with starter-interrupt feature.
- Power-operated, retractable halogen headlamps.
- Center high-mounted stop lamp located in rear bumper fascia above license plate pocket on Convertible, roof mounted on Coupe.
- Full instrumentation.
- Computer Command Control.
- Aluminum intake manifold with tuned runners.
- Aluminum cylinder heads.
- Magnesium valve rocker covers.
- Outside-air induction system.
- Electric in-tank twin turbine fuel pump.
- 20-gallon fuel tank.
- High Energy ignition system.
- Delco-tron generator with built-in solid-state regulator.
- Underhood lamps.
- Headlamp-on reminder.
- Leather-wrapped steering wheel.
- Tilt-Telescopic steering wheel and column.
- Glove compartment lock and lamp.
- Intermittent windshield wipers.
- Center console with shifter and coin tray; includes controls for windows, radio, air conditioning and electric mirror controls.
- Day/night rearview mirror with map and ashtray light.
- Deep-twist floor and stowage area carpet.
- Acoustical insulation package.

*May be deleted for credit

Refer to Dealer Order Guide for option availability and application.

POPULAR MODELS & COLORS

1987 EXTERIOR COLORS

13 - Silver Metallic
18 - Medium Gray Metallic
20 - Medium Blue Metallic
35 - Corvette Yellow
40 - White
41 - Black
53 - Gold Metallic
59 - Silver Beige Metallic
69 - Medium Brown Metallic
74 - Dark Red Metallic
81 - Bright Red

POPULAR SELLING EXTERIOR COLORS

(MODEL YEAR '86 THROUGH FEBRUARY)

1. 81 - Bright Red; 27.0%
2. 41 - Black; 16.0%
3. 40 - White; 14.0%
4. 74 - Dark Red Metallic; 11.0%
5. 18 - Medium Gray Metallic; 10.0%
6. 59 - Silver Beige Metallic; 9.0%

MODEL MIX

(MODEL YEAR '86 THROUGH FEBRUARY)

■ Corvette Coupe (1Y07); 100%

All illustrations and specifications in this brochure are based on the latest product information available at the time of publication approval. The right is reserved to make changes at any time, without notice, in colors, materials, specifications and models, and also to discontinue models. Chevrolet Motor Division, General Motors Corporation, Warren, Michigan 48090
Lithe in USA



4724/486

CORVETTE

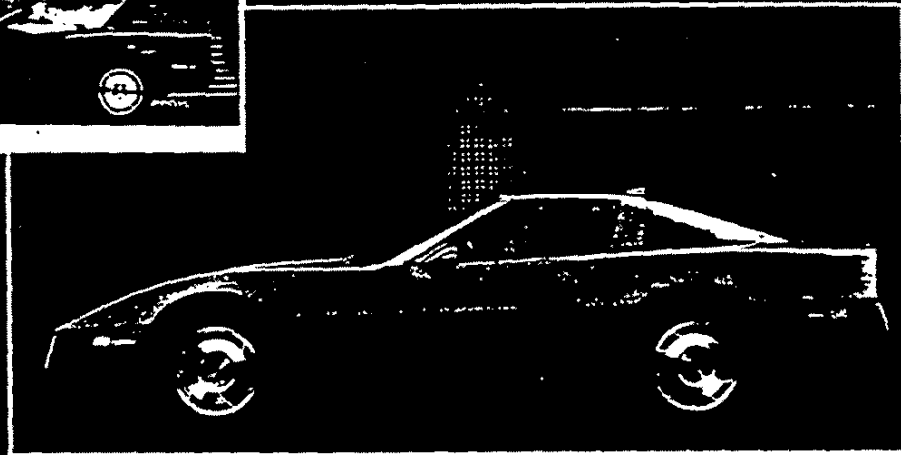
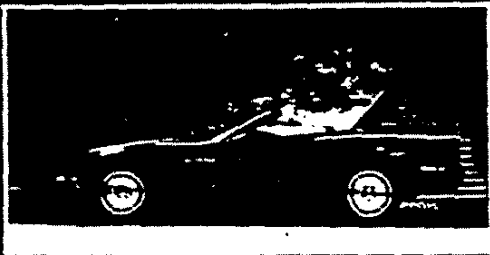

MODEL AVAILABILITY, TRIM LEVELS

	CORVETTE
2-DOOR COUPE	X
2-DOOR CONVERTIBLE	X

MAJOR STANDARD FEATURES

- 5.7L V8 engine with Tuned-Port Fuel Injection
- Aluminum intake manifold with tuned runners and aluminum cylinder heads
- Choice of 4-speed automatic with overdrive or 4-speed manual with overdrive in top three gears (at no charge)
- Power rack-and-pinion steering
- Bosch ABS II 4-wheel anti-lock disc brakes with power assist
- Independent front and rear suspension
- Seating for two
- Cloth bucket seats with lateral support and back angle adjustments
- Electronic liquid crystal instrumentation with multicolored analog and digital display in either English or Metric readout
- Driver information system with instant MPG, average MPG and range readouts
- Electronically tuned, Seek-and-Scan AM/FM stereo with digital clock, four speakers, power operated antenna
- Power-adjusted outside rearview mirrors
- Cast alloy aluminum wheels with Goodyear Eagle VR50 unidirectional steel-belted radial tires
- Air conditioning
- Power windows
- Intermittent windshield wipers
- Leather-wrapped steering wheel and tilt-telescopic column
- Full glass rear hatch with three remote releases and roller-shade cargo cover (coupe)
- One-piece removable fiberglass roof panel (coupe); full folding roof (convertible)
- Vehicle anti-theft system (VATS) with specially coded ignition system and starter-interrupt feature
- Headlamp-on reminder system
- Power-operated, retractable halogen headlamps

CORVETTE CONVERTIBLE ADDS:

- Folding top in black cloth or white or saddle vinyl plus storage compartment
- 16-inch aluminum wheels
- Structurally reinforced uniframe and rear underbody reinforcements

POPULAR OPTIONS

- 6-way driver and passenger power seats
- Removable roof panels (blue or bronze transparent tint, or dual removable panels)
- Defogger system, including rear window defogger and heated outside rearview mirrors (coupe only)
- Electronic speed control
- Electronic control air conditioning that adjusts to preset interior temperature
- Power door lock system
- Delco Bose music system with sound tailored to Corvette interior
- Performance Handling (Z51) and Sport Handling (Z52) Packages with Delco Bilstein shocks, 16-inch wheels and more
- Illuminated vanity mirror on driver's sunshade



2

3

4

5



PRODUCT FEATURES

Wind deflectors added to outside rear-view mirrors

5.7 Liter TPI V8 with aluminum cylinder heads

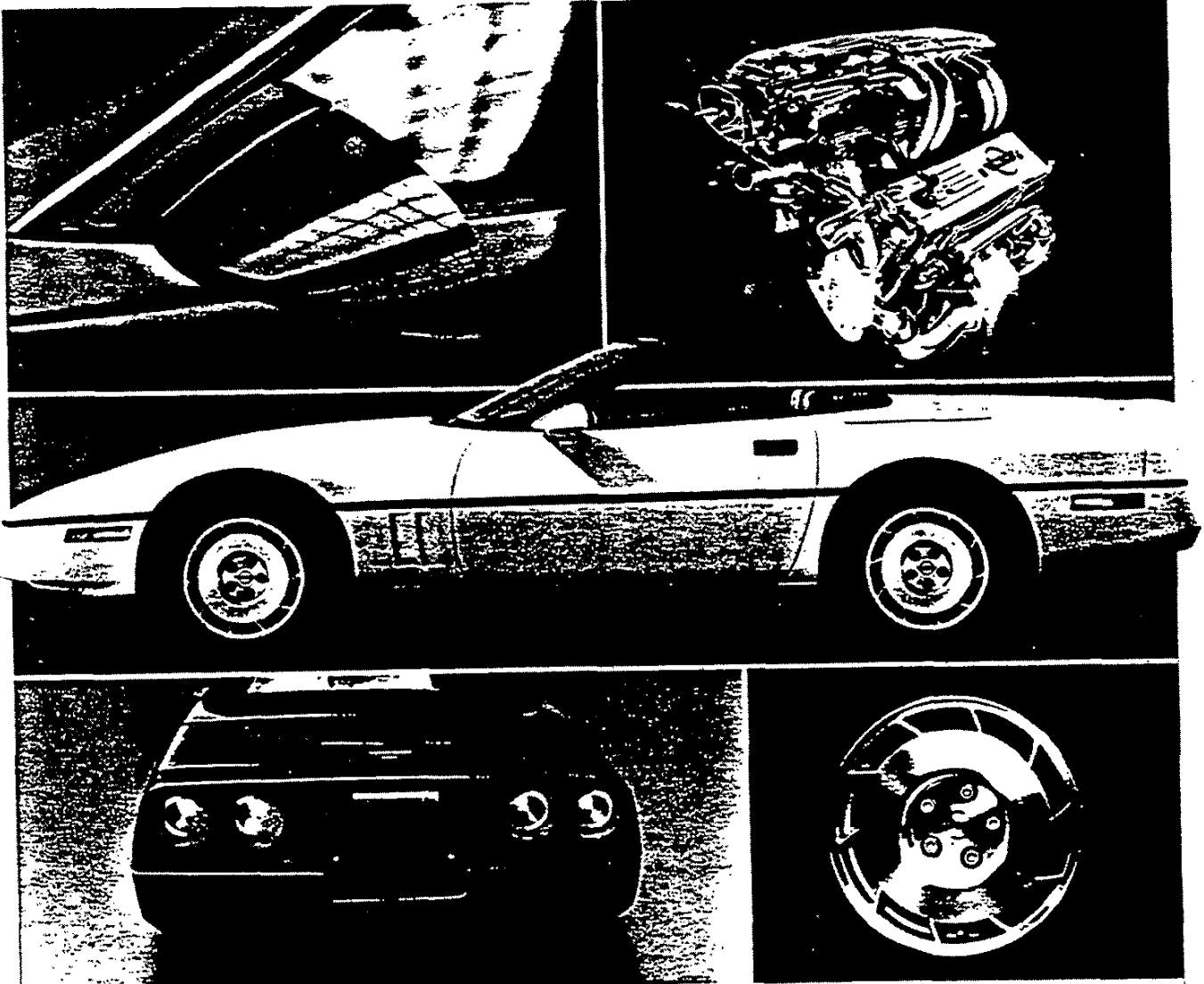

Center high-mounted stop lamp in rear bumper fascia on Convertible

Center: 1987 Corvette Convertible

Corvette standard wheel

Refer to dealer Order Guide for option availability and application.

INTERIORS

STANDARD CLOTH

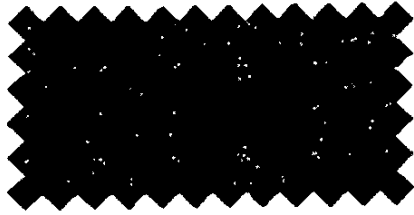

Standard sport cloth interior available in: Graphite, Gray, Blue, Saddle or Bronze.

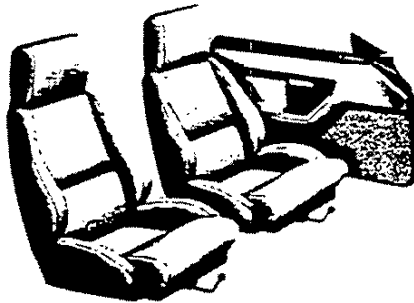

Standard reclining Bucket Seats with integral head restraints and wool-pad comfort liner. Cloth standard; leather optional.

OPTIONAL LEATHER

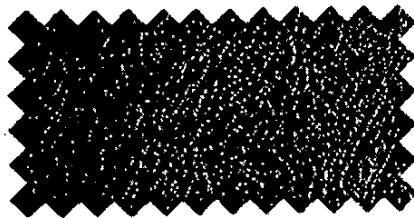

Optional leather seating surfaces available in: Graphite, Gray, Saddle, Bronze, Blue or Red.

OPTIONAL LEATHER ADJUSTABLE SPORT BUCKET

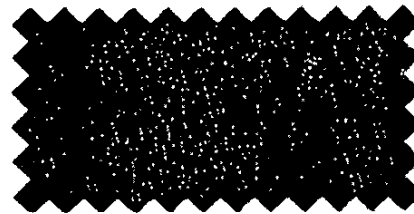

Optional leather Sport Buckets available in: Graphite, Gray, Saddle, Bronze, Blue or Red.

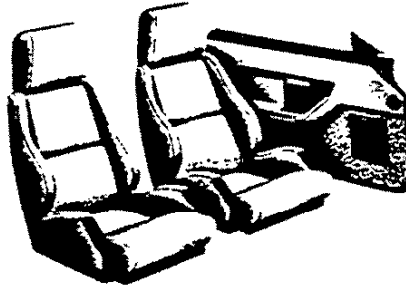

Optional adjustable Sport Buckets with integral head restraints and wool-pad comfort liner; available in leather only. Both driver and passenger seats feature full power adjustment for lumbar, backrest and backrest bolster adjustments to provide a high degree of versatility for practically every human form.

CUSTOM TWO-TONE (RPO D84)

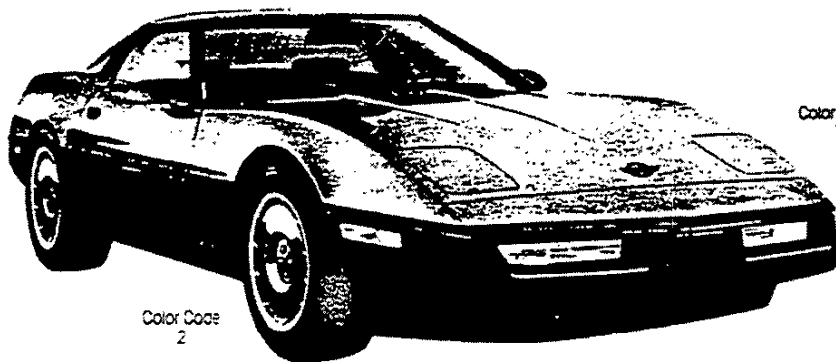

Custom Two-Tone exterior with accent color on body sides and fenders separated by body side moldings.

Refer to Dealer Order Guide for option availability and application.

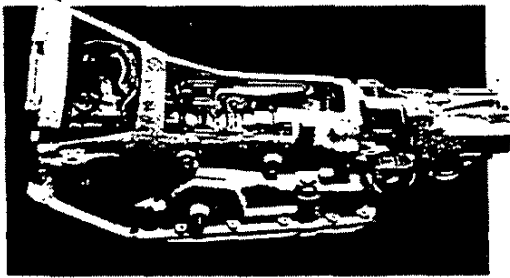

Corvette comes with automatic transmission with overdrive and torque converter clutch.

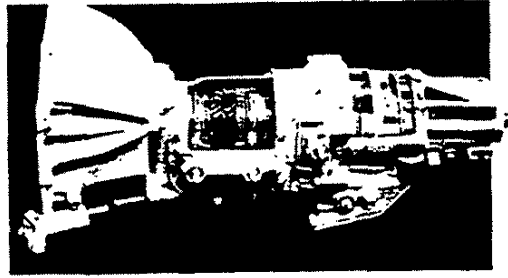

Available at no additional cost, the 4-speed manual transmission has computer-controlled overdrive in top three gears.



Clam-shell hood tilts forward, easing access to engine compartment components.

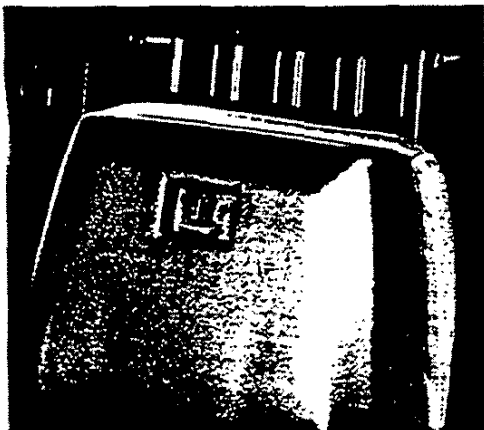

Seat release button

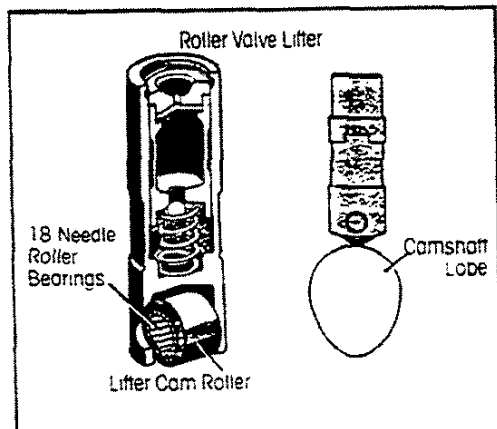

Hydraulic roller valve lifter reduces friction in valve train



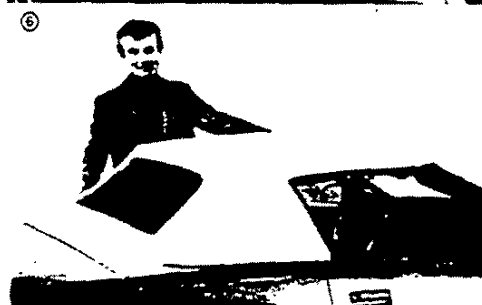
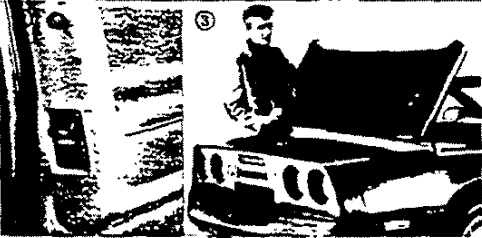
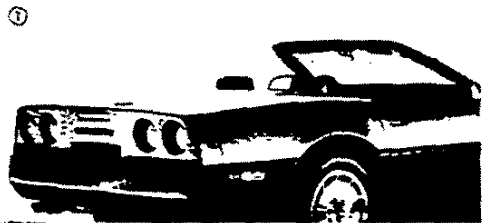

① Corvette Convertible's top hides beneath top stowage compartment lid when folded.
 ② To raise top, first unlatch lid with door panel-mounted button. ③ Lid moves to vertical position for access to folded top
 ④ Lightweight top framework utilizes extruded aluminum members and Teflon bushings to ease operation. ⑤ Closed compartment lid now provides base for top to rest on. ⑥ Clear plastic backlight provides rear vision with top up.



Dual remote-control outside rearview mirrors are equipped with air deflectors for a more integrated appearance.

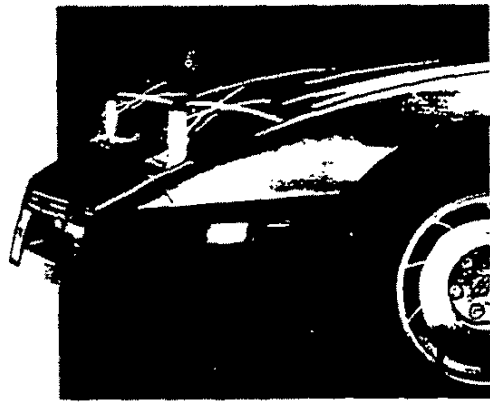

Powerful electric motors rotate the quartz-halogen headlamps into On or Off positions.



CORVETTE CONVERTIBLE

Features Shown in Bold Type Are Specific to This Model.

INTERIOR FEATURES

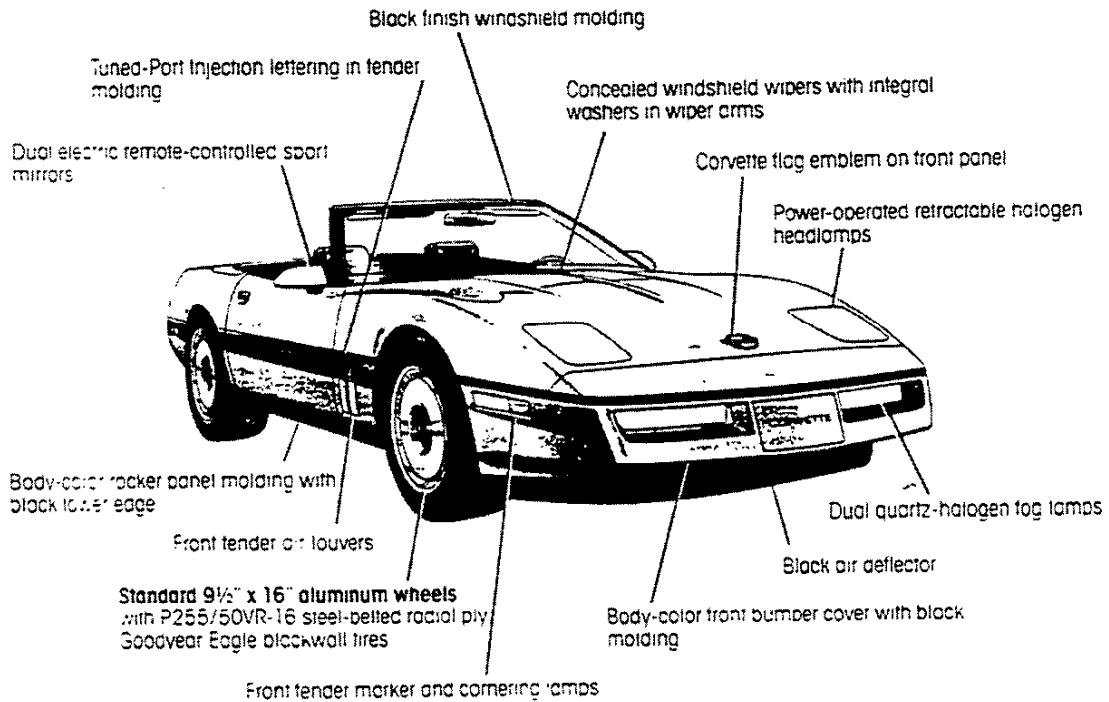
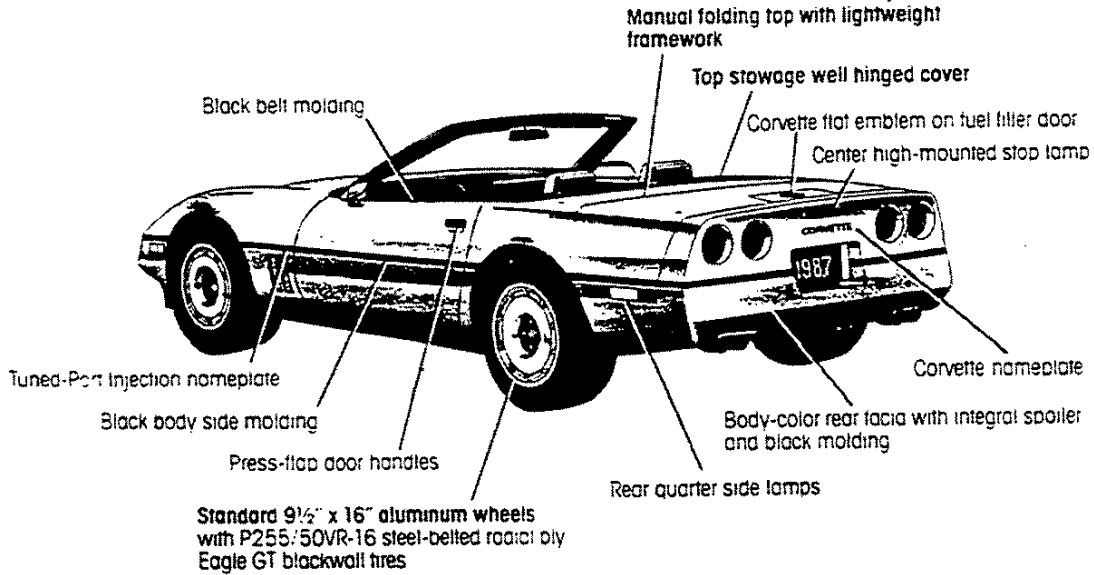



INSTRUMENT PANEL FEATURES (some available features shown)

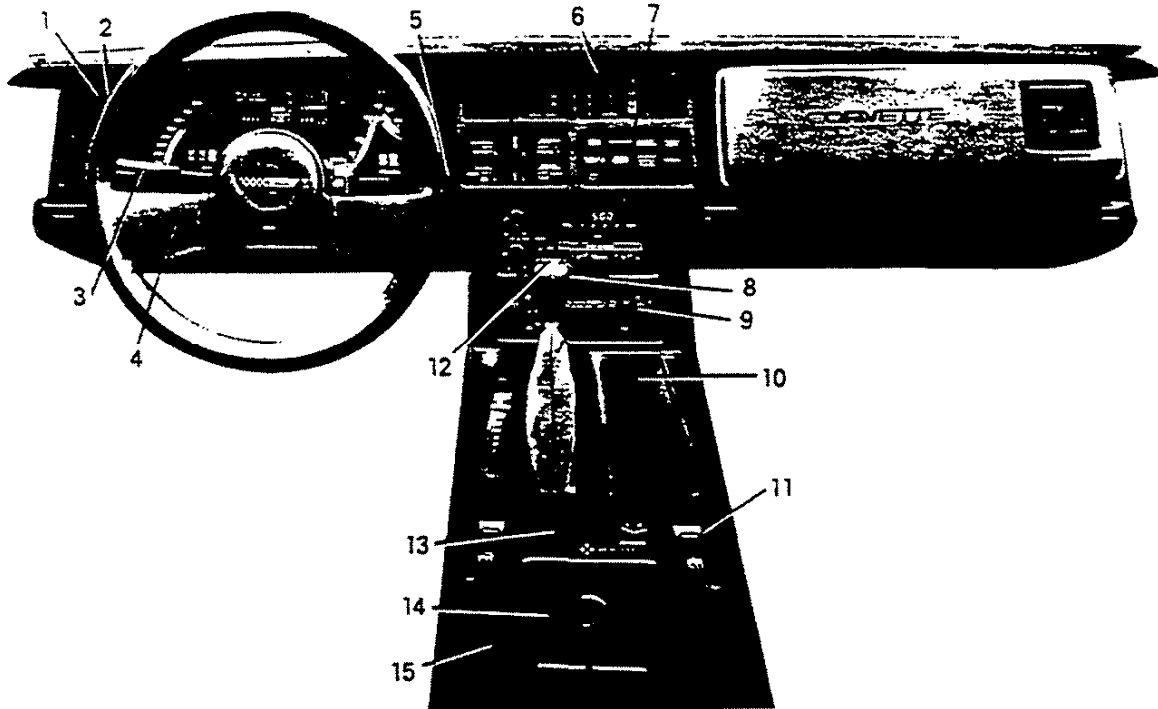

OPTIONS & ACCESSORIES

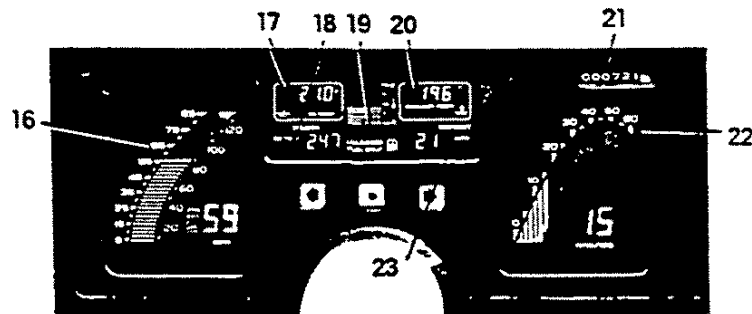

Corvette full LCD digital instrumentation readouts shown in regular (English) mode.

- | | | |
|---|--|---|
| <ul style="list-style-type: none"> 1. Light and headlamp rotation switch 2. Fog lamp switch 3. Column-mounted multi-function turn signals/headlamp dimmer switch and optional cruise control (RPO K34) 4. Leather-covered, two-spoke steering wheel with padded hub 5. Switch for English/metric readouts 6. Air conditioning outlets 7. AM/FM ETR™ stereo radio w/seek and scan, digital clock* | <ul style="list-style-type: none"> 8. Leather-wrapped shift lever knob and boot 9. Heater and air conditioning controls 10. Cigarette lighter and ashtray 11. Power window switches 12. Manual transmission Overdrive Engaged switch on shift knob 13. Power Sport mirror controls 14. Electric rear hatch release (forward wall of glove compartment) 15. Locking glove box includes cassette storage compartment and coin holder | <ul style="list-style-type: none"> 16. Speedometer—English and metric (analog—5-85 MPH, 10-140 kph; digital reads actual speed) 17. Oil pressure or temperature readouts (metric or English) 18. Range and trip odometer readouts (metric or English) 19. Fuel gage with reserve and UNLEADED FUEL ONLY note 20. Engine coolant temperature and voltage readouts (metric or English coolant temperature) 21. Odometer—miles 22. 6000 RPM tachometer 23. Instantaneous or average fuel economy readouts (metric or English) <p>*May be deleted for credit (optional radio shown)</p> |
|---|--|---|





Dual Roof Panel Package includes lift-off solid and transparent (blue- or bronze-tinted) panels.

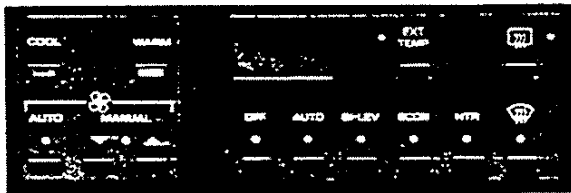

Electronic Control Air Conditioning automatically adjusts to preset interior temperature; now available in Coupe and Convertible

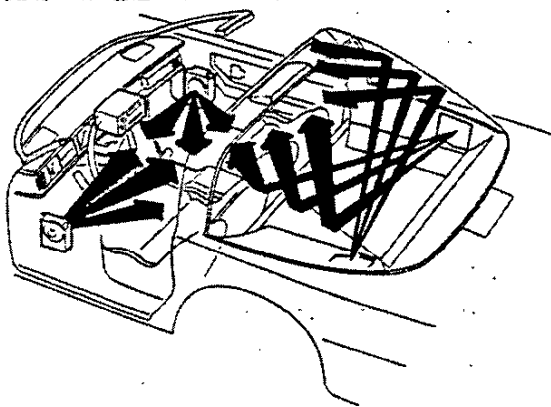

Delco-Base Sound System tailors stereo sound to Corvette interior

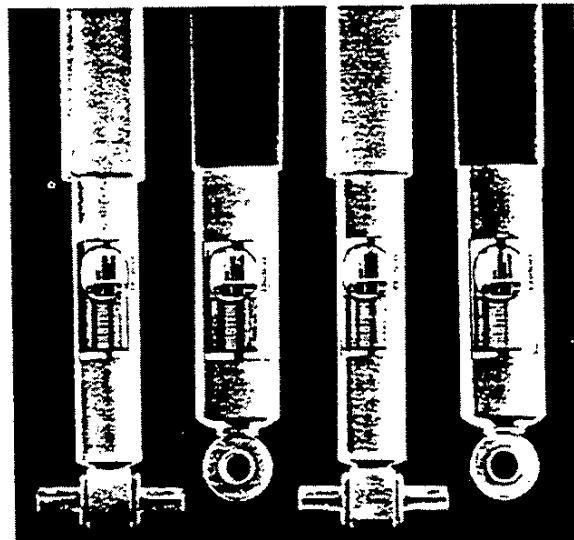

Z51 Performance Handling Package includes Delco-Bilstein gas-charged shock absorbers and other specific components to aid Corvette's off-road handling and performance; available for Coupe only.

EQUIPMENT SUMMARY

POWER TEAMS/ CHASSIS/MECHANICAL	Corvette Coupe	Corvette Conv.
Computer Command Control	S	S
5.7 Liter TPI V8 engine (Tuned-Port Fuel Injection)	S	S
Automatic transmission with overdrive in third and fourth gear	S*	S*
Aluminum intake plenum, tuned crossover runner manifold	S	S
Stainless steel exhaust manifolds and free-flow mufflers	S	S
Roller hydraulic valve lifters and exhaust valve rotators	S	S
Aluminum cylinder heads	S	S
Magnesium engine valve covers	S	S
Poly-Vee single-belt engine accessory drive belt	S	S
Electric in-tank positive displacement roller vane fuel pump	S	S
Electric engine coolant fan	S	S
High Energy Ignition system	S	S
Delco Freedom Plus II battery with sealed side terminals	S	S
Power rack-and-pinion steering	S	S
Power anti-lock disc brakes at all four wheels with 11.5" rotors and finned aluminum calipers	S	S
Exclusive monoleaf glass-epoxy composite transverse front and rear springs	S	S
Forged aluminum front and rear suspension arms	S	S
Limited-slip differential	S	S
Sturdy uniframe body structure 100% galvanized and dip-painted	S	S
Full independent four-wheel suspension	S	S
P255 R-16 steel-belted radial ply blackwall tires (Goodyear Eagle VR50)	S	S
Cast alloy aluminum wheels, steel compact spare	S	S
Center high-mounted stop lamp	S	S
Vehicle anti-theft system with encoded key	S	S
Side lift lock	S	S

EXTERIOR	Corvette Coupe	Corvette Conv.
Front fender louvers	S	S
Front cornering lamps	S	S
Clear lens rear illuminating marker lamps	S	S
Automatic power antenna	S	S
Power-operated quartz-halogen retractable headlamps	S	S
Dual quartz-halogen fog lamps in grille opening	S	S
Dual electric remote-controlled sport mirrors	S	S
Tinted and flush-mounted glass	S	S
Full-tilting clam-shell-type hood	S	S
Single removable roof panel	S	NA

EXTERIOR (Cont'd)	Corvette Coupe	Corvette Conv.
Cloth folding top with aluminum framework	NA	S
Styled engine compartment	S	S
Designed-in body side molding	S	S
Frameless rear hatch glass with three remote releases	S	NA
Body-color front and rear side moldings	S	S
Energy-absorbing bumper systems	S	S
Corrosion-resistant fiberglass body panels	S	S
Concealed wipers with integral washers in wiper arms	S	S

INTERIOR	Corvette Coupe	Corvette Conv.
Contour-shell cloth bucket seats with lateral support and back-angle adjustment	S	S
Soft-padded and carpeted door panels	S	S
Power windows	S	S
Side window defogger	S	S
ETR™ AM/FM stereo radio w/ seek and scan, digital clock and four speakers	S	S
Air conditioning	S	S
High-intensity interior lamps on door and pillar (Coupe) or in rear compartment (Conv.)	S	S
Underdash courtesy lamps	S	S
Twin underhood lamps	S	S
Headlamp-on reminder	S	S
Intermittent windshield wipers	S	S
Illuminated RH visor vanity mirror	S	S
Leather-wrapped steering wheel	S	S
Tilt-Telescopic steering wheel	S	S
Driver information system: includes instant MPG, average MPG, and range in digital readouts	S	S
Ultracontemporary instrument panel featuring electronic liquid-crystal instrumentation with multi-colored analog and digital display. Readouts include: speedometer, 6,000 RPM tachometer, fuel level, oil pressure, oil temp., voltmeter. Conventional readouts for odometer, turn signals and high-beam headlamps	S	S
Manual inside hood release	S	S
Center console with shifter, coin tray, cigarette lighter and ashtray, power window, radio, air conditioning controls, electric mirror controls and override switch for 4-speed manual transmission on shift knob	S	S
Day/night rearview mirror with integral map lamps	S	S
Deep-hurst floor and storage area carpet	S	S
Rear underfloor storage compartments (2)	S	NA
Acoustical insulation package	S	S
Luggage compartment concealment roller shade	S	NA

S - Standard NA - Not Available *4-Speed manual with 2nd, 3rd, 4th automatic overdrive optional at no extra cost **May be deleted for credit

1. Twin underhood lamps
2. Clamshell hood opening for convenient engine access
3. Thermostatically controlled electric cooling fan
4. 64° windshield angle
5. One-piece removable roof panel

6. Center high-mounted stop lamp
7. Full-opening glass hatch with concealed hinges
8. Roller-shade-type cargo cover and twin, covered stowage bins
9. Concealed gas filler with cap holder

10. Front cornering lamps
11. Retractable, aerodynamic halogen headlamps
12. Tires: P255/50VR-16 Goodyear Eagle VR50 blackwalls standard
13. Four-wheel disc brakes with 11.5" rotors and finned aluminum calipers

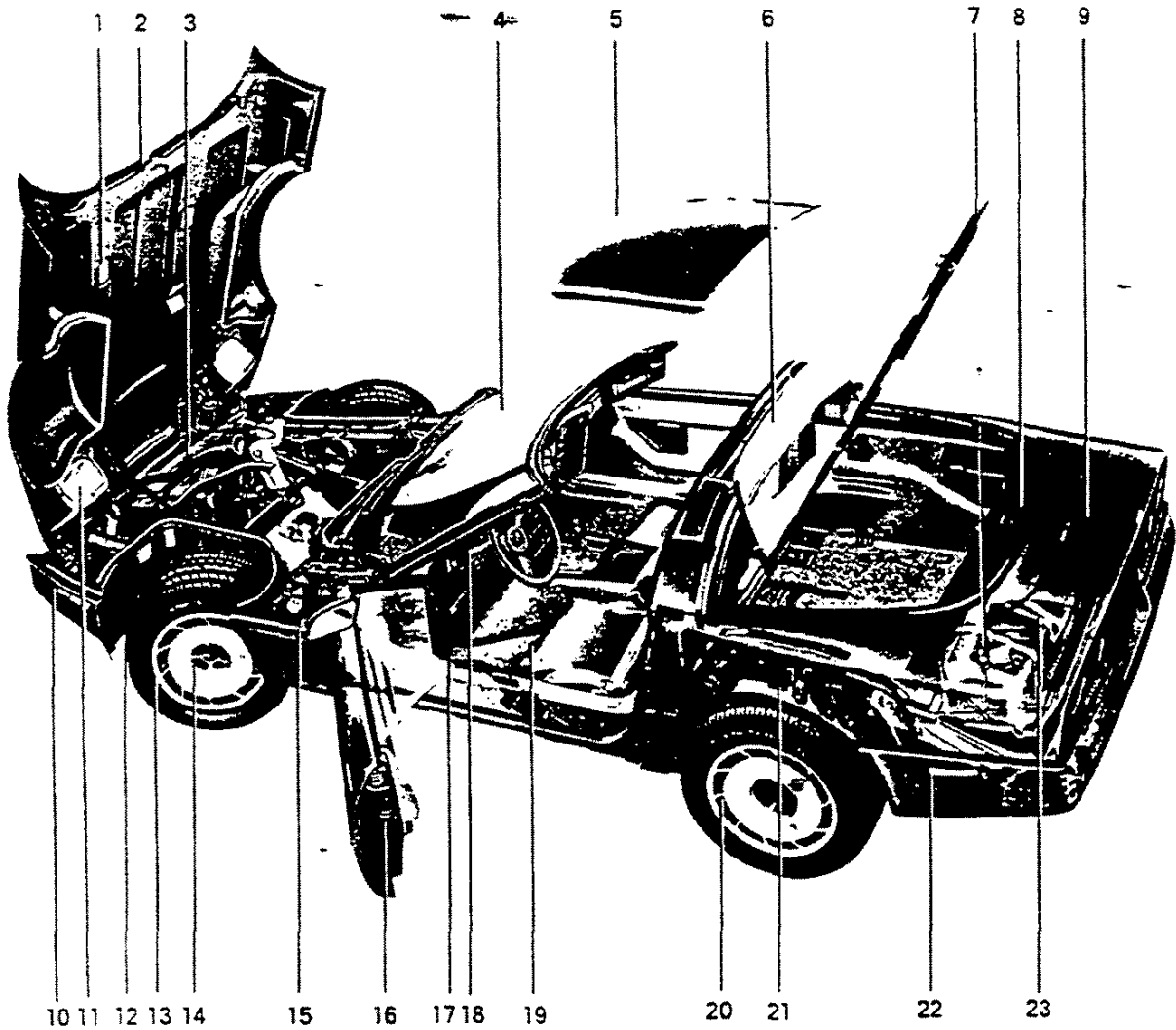

14. Special wheel-bolt locks standard
15. Electrically operated outside mirrors
16. Rear hatch release at each door and in console
17. Left-hand parking brake returns to down position after application

18. Tilt-Telescopic steering wheel
19. Contoured reclining seats with lateral support and wool-pad comfort liner
20. Cast alloy wheels 16" x 8 1/2" standard, 16" x 9 1/2" on Convertible, and with Performance Handling Package (RPO Z51—shown) or Sport Handling Package (RPO Z52)

21. Five-link independent rear suspension with transverse component epoxy spring
22. Rear clear-lense illuminating side marker lamps
23. 20-gallon fuel tank with positive displacement roller vane electric fuel pump

BODY FEATURES • POWER TEAMS • DIMENSIONS

B BODY FEATURES

The Bowling Green, Kentucky, plant that was new in 1981 and refurbished for the totally new 1984 Corvette, allowed for a whole new approach in dedication to quality by designers, engineers, talented workers and managers. Total commitment and pride in workmanship are evident throughout the entire building process.

A Match Check Frame is a key part of carrying the quality commitment to completion. It serves as a full-size "blueprint" used to check every structural part. And these parts must be built to minute tolerances.

The two-stage automatic welder produces a skeleton as it "builds" the Corvette uniframe automatically, applying 142 precision welds in a matter of 97 seconds. It's a state-of-the-art engineering marvel that creates a solid structure with built-in dimensional stability.

This uniframe design is light, yet stiff in bearing, with excellent torsional characteristics. All-steel substructure is extensively treated and coated to inhibit corrosion. Dash, plenum, front and rear underbody

panels, door sealing panel and roof and quarter panel are adhesively bonded to the uniframe. Front-end panel is bolted on for improved panel fit and repairability. Exposed bond seams are eliminated.

High technology comes into play now with the new paint process. Computer-controlled robots are now used to help assure a more uniform finish for every step in the painting process. All colors are formulated with high-solids acrylic enamel base. For a good match between body and front and rear "soft" facias, the base coat is common. This was a recent innovation, starting with the 1984 Corvette. Base coat non-metallic colors are also common between body and facias. All colors are finished with a clear coat.

The chassis, drive train and suspension are married to the body in a specially built new hydraulic "low-vever" interlocking system which helps assure that every contact point will match.

Application of computer technology at Bowling Green is among the highest in the industry. There

are computers to double-check the computer.

CRT terminals are used for inventory control, part location/delivery, manpower control and quality control. Computer-generated inspection tickets follow a new Corvette throughout the assembly process. Even the front suspension and rear-wheel alignment on the new Corvette is computerized for precise accuracy.

Each day there is a "Morning Audit." Salaried and hourly employees meet to examine cars in detail. They discuss quality reports from the previous day's production and consider any ideas that might lead to improvements. They search for ways to assure and enhance the quality of Corvette.

It is typical of the attention to detail in evidence throughout the plant. Here, we've assembled talented workers and some of the most modern production equipment available today. And it is *the* Corvette plant. One plant, one group of people, dedicated to building one brand, at a deliberate pace of just a few cars each hour.

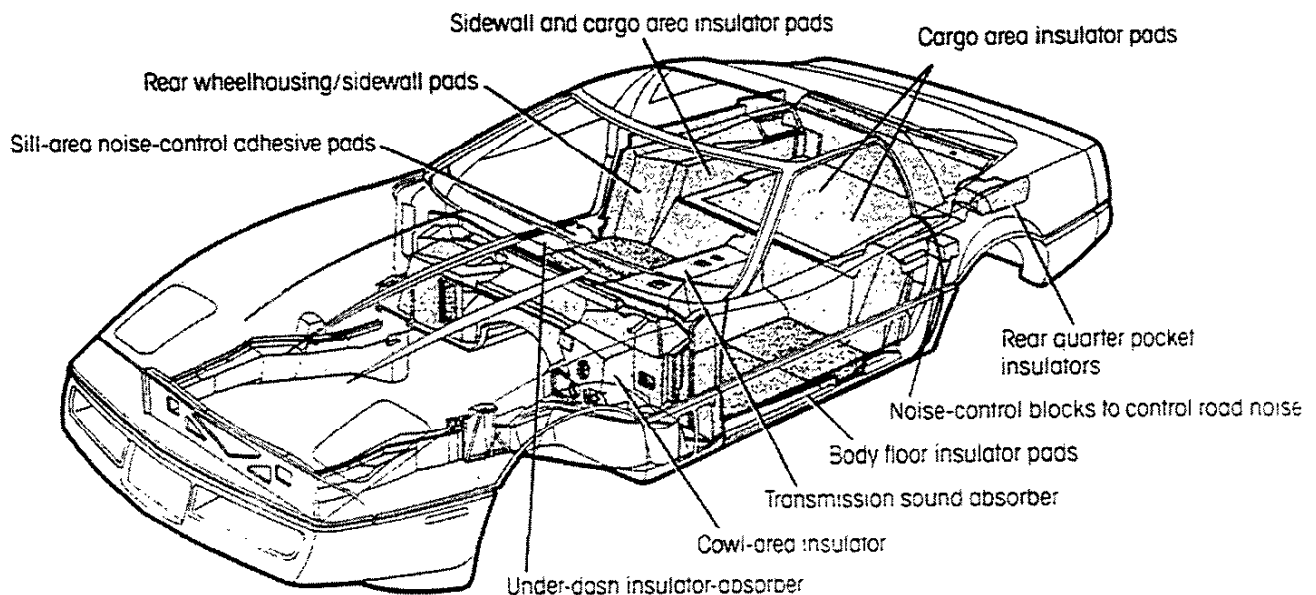

FOR A HUSHED, QUIET RIDE...

Keeping "unwanted" sounds out of the passenger compartment is a primary goal of automotive acoustical engineers. Wind noise, road noise and other errant sounds should be kept where they belong... outside. However, in a GT sports car like the Corvette, the throaty sound of exhaust notes can be highly desirable. And it is this kind of balance

that has been struck in the new world-class Corvette. It's a car that goes like it should, sounds like it should, but doesn't create an assault on the occupants at the same time. Flush-mounted windshield and rear window (on Coupe), plus the absence of protrusions to interrupt the wind, help give the car an ability to slip through the wind with a minimum of noise. These, in addition to the inherent sound-deadening

qualities of fiberglass bonded to the steel uniframe, provide an excellent base for further acoustical engineering. Various insulator pads of acoustical material literally surround the driver and passenger with a barrier against outside, unwanted sounds. The illustration on this page shows some of the materials and location of many of these lightweight, highly effective insulators.

POWER TEAMS

Engine	Ordering Code	Engine Availability	Transmission Availability		Rear-Axle Ratios	
			Four Speed Manual w/Automatic Overdrive RPO MM4	Four-Speed Automatic w. Overdrive RPO MX0	Four Speed Manual RPO MM4	Automatic w Overdrive RPO MX0

ALL STATES

5.7 Liter TPI* V8	RPO L98	STD	OPT	STD	3.07*	2.59*
-------------------	---------	-----	-----	-----	-------	-------

*Tuned-Port Fuel Injection **3.07 with G92 performance ratio and Z51 Performance Handling Package STD-Standard OPT-Optional at no charge

ENGINE SPECIFICATIONS

	5.7 Liter TPI V8
ENGINE TYPE	90° V8-OHV
DISPLACEMENT (CU. IN.)	350
BORE AND STROKE (IN.)	4.00 x 3.48
HP* @ RPM	240 @ 4000
TORQUE* @ RPM (LBS.-FT.)	345 @ 3200
COMPRESSION RATIO	9.5:1
FUEL INDUCTION	Tuned-Port Fuel Injection (TPI)
FUEL REQUIREMENT	91-Octane Rating Unleaded Gasoline*
CHOKE	None Required
VALVE LIFTERS	Roller Type Hydraulic
ENGINE EXHAUST	Dual

	5.7 Liter TPI V8
CATALYTIC CONVERTER	Dual Bed with Monolith Substrates**
MUFFLER/S	Dual Free-Flow Type
RESONATOR/S	None
TAILPIPE/S	Dual
IGNITION SYSTEM	12-Volt High Energy Ignition
DELCOTRON GENERATOR	105 Amp
BATTERY (SAE CAPACITY RATING) -Cold Crank Amps	630 Amp
SPARK PLUGS	FR3LS
COOLING SYSTEM CAPACITY (QTS.)	14.7 Manual 14.5 Automatic
CRANKCASE CAPACITY (QTS.)	5-Less Filter

OHV-Overhead Valve *SAE net **85 octane rating may be used in certain high-altitude areas specified in Owner's Manual. Gasohol of equivalent octane rating may also be used, provided it is blended at not more than 10% ethanol. **Free-flow converter with wide-oval inlet and outlet

DIMENSIONS, SPECIFICATIONS & SERVICE INTERVALS

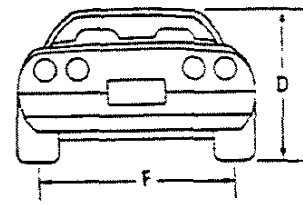
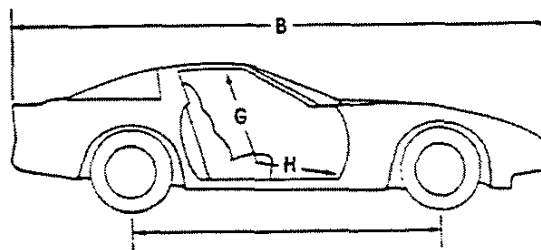
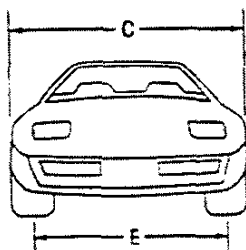

EXTERIOR DIMENSIONS (in.)	Hatchback	
	Coupe	Convertible
A Wheelbase	96.2	96.2
B Length (overall)	176.5	176.5
C Width (overall)	71.0	71.0
D Height (overall)	46.7	46.4
E Tread-front	59.6	59.6
F Tread-rear	60.4	60.4
Minimum ground clearance	4.7	4.7

INTERIOR ROOMINESS (in.)	Hatchback	
	Coupe	Convertible
G Head room-front	36.4	36.5
H Leg room-front	42.6	42.6
Shoulder room	54.0	54.0
Hip room	49.3	49.3

LUGGAGE/CARGO COMPARTMENT	Hatchback	
	Coupe	Convertible
Cargo volume (cu. ft.)	17.9	6.6
RATED FUEL TANK CAPACITY (gallons)	20.0	20.0
CURB WEIGHT (approx. pounds)		
With automatic transmission	3225	3239
With manual transmission	3216	3279

SERVICE INTERVALS*

Engine Oil	12 months or 7,500 miles
Oil Filter	12 months or 7,500 miles, every 15,000 miles thereafter
Spark Plugs	Up to 30,000 miles
Chassis Lubrication	** 2,000 months or 7,500 miles
Automatic Transmission Fluid Change	Every 100,000 miles

*Consult Owner's Maintenance Schedule for operating conditions requiring more frequent service intervals.

COLOR & TRIM SELECTIONS

(Note: See Interior Colors [page 16] for specific seat trim illustrations using number code indicated.)

Models	Seat Type	Interior Colors					
		Blue	Bronze	Graphite	Gray	Red	Saddle
Corvette Coupe	Standard Cloth Bucket	X/7	X/8	X/9	X/10		X/11
	Optional Leather Bucket	X/1	X/2	X/3	X/4	X/5	X/6
Corvette Convertible	Optional Leather Adjustable Sport Bucket	X/1	X/2	X/3	X/4	X/5	X/6

Exterior Colors	Color Code	Conv. Top Color	Conv. Top Color	Conv. Top Color	Conv. Top Color	Conv. Top Color	Conv. Top Color
Silver Metallic	13			X 11T/19T	X 11T/19T	X 11T/19T	
Medium Gray Metallic	18			X 11T/19T	X 11T/19T	X 11T/19T	
Medium Blue Metallic	20	X 11T/19T		X 19T			
Yellow	35			X 11T/19T			X 19T
White	40	X 11T	X 11T	X 11T/19T	X 11T/19T	X 11T	X 11T/67T
Black	41			X 11T/19T	X 11T/19T	X 19T	X 19T/67T
Gold Metallic	53			X 19T			X 19T/67T
Silver Beige Metallic	59			X 19T			
Copper Metallic	66			X 11T/19T			X 67T
Medium Brown Metallic	69		X 67T				X 67T
Dark Red Metallic	74			X 11T/19T			X 67T
Bright Red	81			X 11T/19T		X 11T/19T/67T	X 67T

Conv. Top Colors 11T... White 19T... Black 67T... Saddle

Coupe Custom Two-Tone Colors (RPO D84)	Upper/Lower				
Silver Metallic/Medium Gray Metallic	13/18			X	X X
Medium Gray Metallic/Black	18/41			X	X
White/Silver Metallic	40/13			X	X
Silver Beige/Medium Brown Metallic	59/69		X		

SEAT & DOOR TRIM

OPTIONAL ADJUSTABLE SPORT SEATS

Both driver and passenger seats feature full power adjustment for lumbar, backrest and backrest bolster adjustments to provide a high degree of versatility for practically every human form. Three separate lumbar supports for the lumbar region are controlled by internal bladder-type cells, powered by an air pump. These cells can be inflated or deflated to give the degree of pressure desired, especially on long drives. Lateral adjustment of the seat-back sides is controlled by a side-bolster power switch. This allows occupants to adjust the backrest sides to a comfortable degree of snugness. Back angle has a 12-degree adjustment range. Separate six-way power adjustments for both driver and passenger are available; fore and aft adjustment is 6.5 inches, with up and down travel of approximately 1.5 inches.

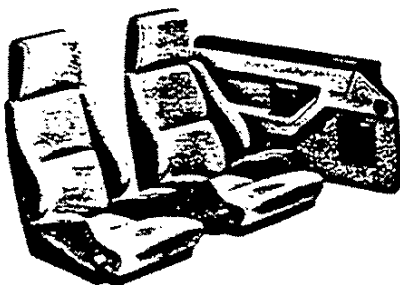
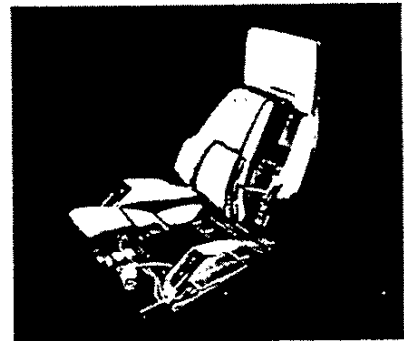

Optional leather adjustable sport seats with integral head restraints and wool-pad comfort liner.

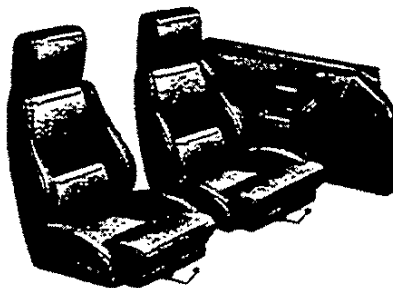

Optional leather reclining bucket seats with integral head restraints and wool-pad comfort liner.



Standard cloth reclining bucket seats with integral head restraints and wool-pad comfort liner.



EXTERIOR COLORS

See Color & Trim Selections chart for specific availability, using the number code indicated.



13-Silver Metallic



18-Medium Gray Metallic

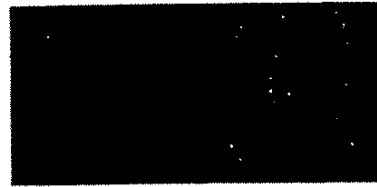

20-Medium Blue Metallic

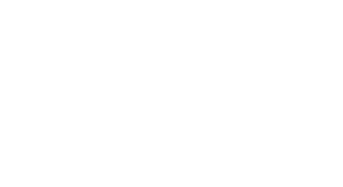

35-Yellow



40-White



41-Black

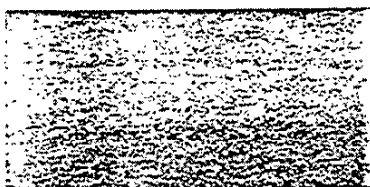

53-Gold Metallic

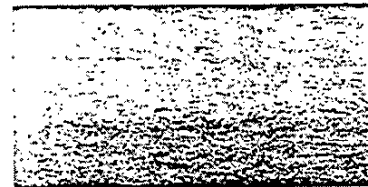

59-Silver Beige Metallic

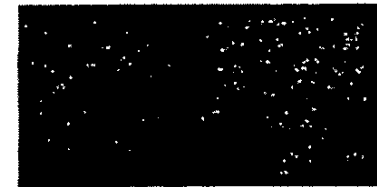

66-Copper Metallic



69-Medium Brown Metallic



74-Dark Red Metallic



81-Bright Red



CUSTOM TWO-TONE COLORS



13-Silver Metallic/
18-Medium Gray Metallic

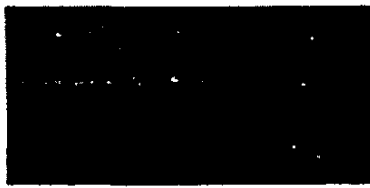

18-Medium Gray Metallic/
41-Black



40-White
13-Silver Metallic



59-Silver Beige Metallic
69-Medium Brown Metallic



INTERIOR COLORS

See Color & Trim Selections chart for specific availability using the number code indicated.

CORVETTE LEATHER SEAT TRIM

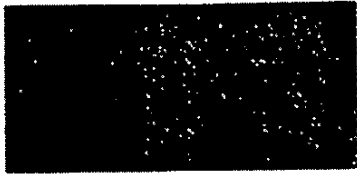

1-Blue*

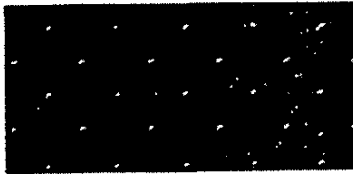

2-Bronze*

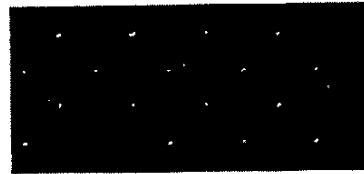

3-Graphite

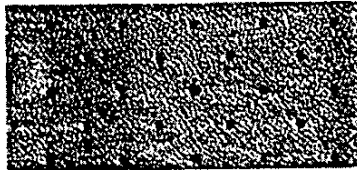

4-Gray*

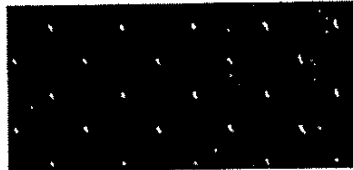

5-Red

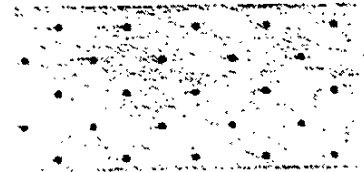

6-Saddle

*Metallic

CORVETTE CLOTH SEAT TRIM



7-Blue

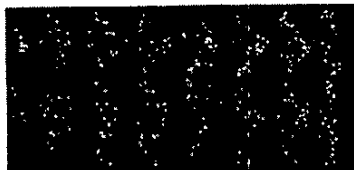

8-Bronze



9-Graphite

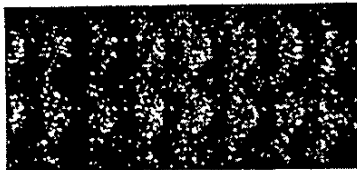

10-Gray

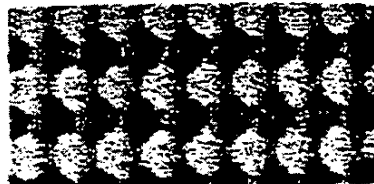

11-Saddle

EXTERIOR DECOR FEATURES

CUSTOM TWO-TONE (RPD 084)

Custom Two-Tone exterior with accent color on body sides and fenders separated by body side moldings.

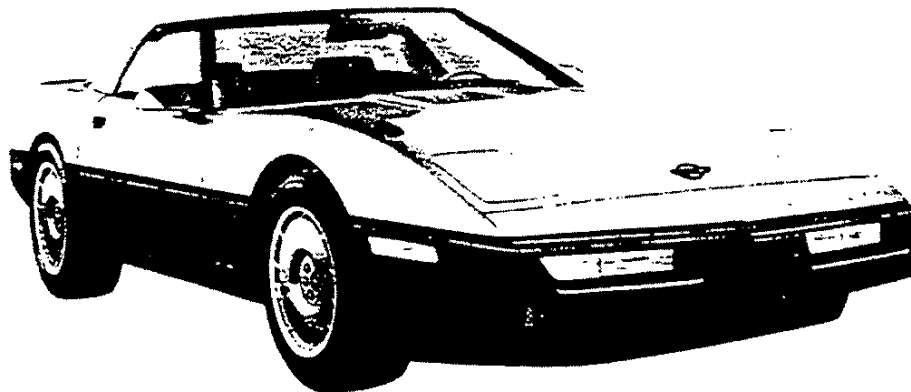

CONVERTIBLE TOP COLORS

Corvette Convertible. Folding top is available in three color choices

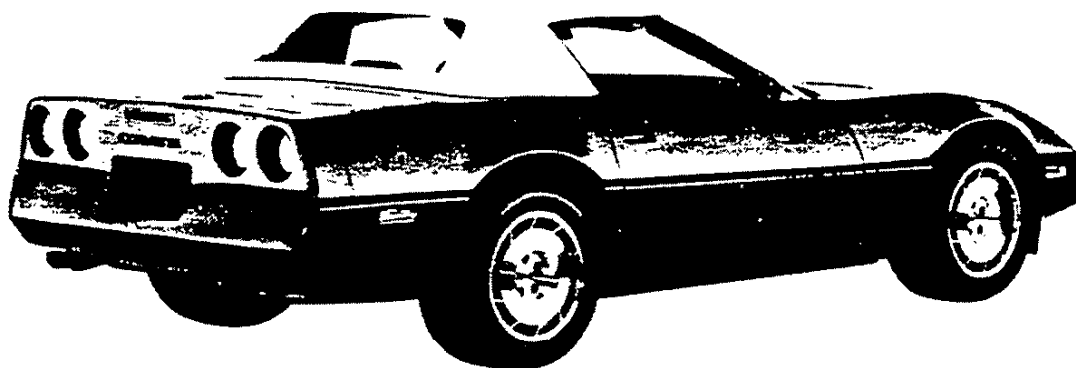

19T Black

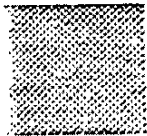

67T Saddle

11T White



MANUFACTURERS MOTOR VEHICLE SPECIFICATIONS

METRIC(U.S. Customary)

Passenger Car

1987

Manufacturer Chevrolet Motor Division General Motors Corporation	Car Line Corvette	
Mailing Address Chevrolet-Pontiac-Canada Group Engineering Center General Motors Corporation 30003 Van Dyke Warren, MI 48090-9060	Issued June, 1986	Revised September, 1986

Questions concerning these specifications should be directed to the manufacturer whose address is shown above.

The information contained herein is prepared, distributed by, and is solely the responsibility of the automobile manufacturing company to whose products it relates. This specification form was developed by the automobile manufacturing companies under the auspices of the Motor Vehicle Manufacturers Association of the United States, Inc.

The General Specifications herein are those in effect at date of compilation and are subject to change without notice by the manufacturer.

Blank Forms Provided by Technical Affairs Division

Motor Vehicle Manufacturers Association
of the United States, Inc.

MVMA Specifications Form Passenger Car

METRIC (U.S. Customary)

Table of Contents

1	Car Models
2	Power Teams
3-6	Engine
4	Lubrication System
4	Diesel Information
5	Cooling System
6	Fuel System
7	Vehicle Emission Control
7	Exhaust System
8-10	Transmission, Axles and Shafts
11	Suspension-Front and Rear
12-13	Brakes
13	Tires and Wheels
14-15	Steering
15-16	Electrical
17	Body – Miscellaneous Information
18	Restraint System
18	Frame
18	Glass
19	Convenience Equipment
20-22	Car and Body Dimensions
23	Vehicle Fiducial Marks
24	Lamps and Headlamps
25	Vehicle Mass (Weight)
26	Optional Equipment Differential Mass (Weight)
27-33	Car and Body Dimensions Definitions - Key Sheets
34	Index

NOTE:

1. This form uses both SI metric units and U.S. Customary units. The metric unit of measure is presented first, and the U.S. Customary unit follows in parentheses.
2. UNLESS OTHERWISE INDICATED:
 - a. Specifications apply to standard models without optional equipment. Significant deviations are noted.
 - b. Nominal design dimensions are used throughout these specifications.
 - c. All linear dimensions are in millimeters (inches), and all mass (weight) specifications are in kilograms (pounds).
3. The General Specifications herein are those in effect at date of completion and are subject to change without notice by the manufacturer.
4. Additional Car and Body Dimensions (based in part on SAE J1100 "Motor Vehicle Dimensions") may be available from the manufacturer.

**MVMA Specifications Form
Passenger Car**

Car Line CORVETTE
 Model Year 1987 Issued 6-86 Revised (e) _____

METRIC (U.S. Customary)

Car Models

Model Description & Drive (FWD/RWD)	Introduction Date	Make, Car Line, Series, Body Type (Mfr's Model Code)	No. of Designated Seating Positions (Front/Rear)	Max. Trunk/Cargo Load—Kilograms (Pounds)
CORVETTE		MODEL NUMBER	FRONT	
2-Door Hatchback Coupe		1YY07	2	45.4 (100)
2-Door Convertible		1YY67	2	45.5 (100)

NOTE: Any specifications on the following pages specific to California requirements are indicated accordingly.

MVMA Specifications Form Passenger Car

Car Line CORVETTE
 Model Year 1987 Issued 6-86 Revised (*) 9-86

METRIC (U.S. Customary)

Power Teams (Indicate whether standard or optional)
 SAE J1349 Net bhp (brake horsepower) and net torque corrected to 77°F/25° C and 29.61 in. Hg/100 kPa atmospheric pressure.

SERIES AVAILABILITY	ENGINE					E x h a u s t S/D	TRANSMISSION/ TRANSAXLE	DRIVE RATIOS (:1) AXLE RATIO			
	Displ. Liters (in ³)	Carb. (Barrels, FI, etc.)	Compr. Ratio	SAE Net at RPM				Overall Base Veh. Drive	Overall Opt. Veh. Drive	Overall Veh. Drive	Overall Veh. Drive
				Power kW (bhp)	Torque N·m (lb. ft.)						
Base-All States Coupe	V8 5.7 Liter (350 CID) L98	TPI @	9.5:1	(240 @ 4000)	(345 @ 3200)	D	*Man. 4-Spd. (2.88 low) Base (MH5)	3.07%	1.84	--	--
							*Man. 4-Spd. (2.88 low) - Opt. (MK2)	3.07%	2.09	--	--
							Auto '700-R4' - Base (MD8)	2.59%	1.81	3.07%#&	2.15
Base-All States Convertible							*Man. 4-Spd. (2.88 low) Base (MH5)	3.07%	1.84	--	--
							*Man. 4-Spd. (2.88 low) - Opt. (MK2)	3.07%	2.09	--	--
							Auto '700-R4' Base (MD8)	2.73%	1.91	3.07%\$	2.15
@ - Tuned Port Fuel Injection * - Automatic Overdrive 2nd, 3rd, 4th gears # - Base with RPO Z51, Performance Handling Package \$ - 200 mm (7-7/8") ring gear % - 216 mm (8-1/2") ring gear & - Optional Ratio - Not available with base radio (UU8)											

MVMA Specifications Form Passenger Car

Car Line CORVETTE
 Model Year 1987 Issued 6-86 Revised (•) 9-86

METRIC (U.S. Customary)

Engine Description/Carb.
Engine Code

5.7 Liter V8 (350 CID)
 Tuned-Port Fuel Injection (TPI)
 RPO L98

ENGINE - GENERAL

Type & description (inline, V, angle, flat, location, front, mid, rear, transverse, longitudinal, sohc, dohc, ohv, hemi, wedge, pre-camber, etc.)	90°V Front Longitudinal
Manufacturer	Chevrolet
No. of cylinders	8
Bore	101.6 (4.00)
Stroke	88.4 (3.48)
Bore spacing (C/L to C/L)	111.8 (4.40)
Cylinder block material & mass kg (lbs.) (machined)	Cast alloy iron 64.750 (142.7)
Cylinder block deck height	229.2 (9.025)
Cylinder block length	Not Available
Deck clearance (minimum) (above or below block)	.025 below
Cylinder head material & mass kg (lbs.)	Aluminum 9.979 (22.0)
Cylinder head volume (cm ³)	Not Applicable
Cylinder liner material	Not Available
Head gasket thickness (compressed)	.021
Minimum combustion chamber total volume (cm ³)	75.47 (+)
Cyl no system (front to rear)*	L. Bank 1-3-5-7
	R. Bank 2-4-6-8
Firing order	1-8-4-3-6-5-7-2
Intake manifold material & mass [kg (lbs.)]**	Cast aluminum 6.700 (14.77)
Exhaust manifold material & mass [kg (lbs.)]**	Stainless steel 2.895 (6.38) L.H., 2.895 (6.38) R.H.
Recommended fuel (leaded, unleaded, diesel)	Unleaded
Fuel antiknock index (R + M) 2	91
Total dressed engine mass (wt) dry***	245.5 (541.2) auto., 268.6 (592.2) manual

Engine - Pistons

Material & mass, g (weight, oz.) - piston only	Impacted cast aluminum, .597 (1.3)
--	------------------------------------

Engine - Camshaft

Location	In cylinder block "V" above crankshaft
Material & mass kg (weight, lbs.)	Cast alloy iron, 4.200 (9.3)
Drive type	Chain/belt
	Width/pitch

* Rear of engine - drive takeoff. View from drive takeoff end to determine left & right side of engine.

** Finished state.

*** Dressed engine mass (weight) includes the following:

All those items necessary to make the engine a complete ready-to-run unit.

(+) - Combustion chamber with piston at top dead center and all components in place torqued to specifications.

MVMA Specifications Form Passenger Car

Car Line CORVETTE
 Model Year 1987 Issued 6-86 Revised (●) _____

METRIC (U.S. Customary)

Engine Description/Carb.
 Engine Code

5.7 Liter V8 (350 CID)
 Tuned-Port Fuel Injection (TPI)
 RPO L98

Engine - Valve System

Hydraulic lifters (std., opt., NA)	Standard	<i>Duration 322°</i>
Valves	Number intake / exhaust	8/8 <i>Lift EX: 423 423"</i>
	Head O.D. intake / exhaust	49.28 (1.94)/38.10 (1.50) <i>IN: 410 410"</i>

Engine - Connecting Rods

Material & mass [kg., (weight, lbs.)]*	1037 or 1038 steel - .388 (0.855)
--	-----------------------------------

Engine - Crankshaft

Material & mass [kg., (weight, lbs.)]*	Nodular cast iron - 22.900 (50.49)	
End thrust taken by bearing (no.)	5	
Number of main bearings	5	
Seal (material, one, two piece design, etc.)	Front	
	Rear	

Engine - Lubrication System

Normal oil pressure (kPa (psi) at engine rpm)	345-450 (50-65) @ 2000
Type oil intake (floating, stationary)	Stationary
Oil filter system (full flow, part, other)	Full flow
Capacity of c/case, less filter-refill-L (qt.)	3.8 (4.0)

Engine - Diesel Information

Diesel engine manufacturer		
Glow plug, current drain at 0°F	Not	
Injector nozzle	Type	Applicable
	Opening pressure (kPa (psi))	--
Pre-chamber design	--	
Fuel injection pump	Manufacturer	--
	Type	--
Fuel injection pump drive (belt, chain, gear)	--	
Supplementary vacuum source (type)	--	
Fuel heater (yes/no)	--	
Water separator, description (std., opt.)	--	
Turbo manufacturer	--	
Oil cooler-type (oil to engine coolant; oil to ambient air)	--	
Oil filter	--	

Engine - Intake System

Turbo charger - manufacturer	Not
Super charger - manufacturer	Applicable
Charge cooler	--

*Finished State

MVMA Specifications Form Passenger Car

Car Line CORVETTE
 Model/Year 1987 Issued 6-86 Revised (●) _____

METRIC (U.S. Customary)

Engine Description/Carb.
 Engine Code

5.7 Liter V8 (350 CID)
 Tuned-Port Fuel Injection (TPI)
 RPO L98

Engine - Cooling System

Coolant recovery system (std., opt., n.a.)		Standard
Coolant fill location (rad., bottle)		Bottle, coolant recovery
Radiator cap relief valve pressure [kPa (psi)]		124.1 (18.0)
Circulation thermostat	Type (choke, bypass)	Choke
	Starts to open at °C (°F)	90.6 (195°)
Water pump	Type (centrifugal, other)	Centrifugal with cast aluminum housing
	GPM 1000 pump rpm	13
	Number of pumps	One
	Drive (V-belt, other)	Single belt poly 'V' accessory drive (serpentine)*
	Bearing type	Sealed double row ball
	Impeller material	
Housing material		
By-pass recirculation [type (inter., ext.)]		Internal
Cooling system capacity	With heater—L.(qt.)	--
	With air cond.—L.(qt.)	Manual 13.86 (14.65), Automatic 13.73 (14.51)
	Opt. equipment [specify—L.(qt.)]	--
Water jackets full length of cyl. (yes, no)		Yes
Water all around cylinder (yes, no)		Yes
Water jackets open at head face (yes, no)		
Radiator core	Std., A/C, HD	A/C, Standard
	Type (cross-flow, etc.)	Cross-flow
	Construction (fin & tube mechanical, braze, etc.)	
	Material, mass [kg (wgt. lbs.)]	Alum. header, tubes and fins, plastic tanks
	Width	599.5 (23.6)
	Height	382.4 (15.0)
	Thickness	23.5 (0.9) base, 34.0 (1.3) V01
	Fins per inch	2.5
Radiator end tank material		Plastic
Fan	Std., elec., opt.	Electric, Standard - Optional, Electric Boost Fan
	Number of blades & type (flex, solid, material)	5-blades, high efficiency curved blades and ring shroud, plastic
	Diameter & projected width	423.0 (16.7)
	Ratio (fan to crankshaft rev.)	--
	Fan cutout type	Temp. switch
	Drive type (direct, remote)	Electric
	RPM at idle (elec.)	2100
	Motor rating (wattage) (elec.)	150 wattage
	Motor switch (type & location) (elec.)	Temp. switch
	Switch point (temp., pressure) (elec.)	106°C
Fan shroud (material)		Plastic-ring shroud

* - 21.36 mm (0.84") wide, 5.20 mm (0.20") thick, with uniform dynamic tensioner.

MVMA Specifications Form Passenger Car

Car Line CORVETTE
 Model Year 1987 Issued 6-86 Revised (*) 9-86

METRIC (U.S. Customary)

Engine Description/Carb.
Engine Code

5.7 Liter V8 (350 CID)
 Tuned-Port Injection (TPI)
 RPO L98

Engine - Fuel System (See supplemental page for details of Fuel Injection, Supercharger, Turbocharger, etc. if used)

Induction type: carburetor, fuel injection system, etc.		TPI - Tuned Port Fuel Injection	
Manufacturer		--	
Carburetor	Choke (type)	--	
	Idle spd. rpm (spec. neutral or drive and propane if used)	Manual	--
		Automatic	--
Idle A/F mix.		Preset - no adjustment provided	
Fuel injection	Point of injection (no.)	Fuel Injectors at inlet ports	
	Constant, pulse, flow	Pulse	
	Control (electronic, mech.)	Electronic - on board computer	
	System pressure [kPa (psi)]		
Intake manifold heat control (exhaust or water thermostatic or fixed)		Water, thermostat	
Air cleaner type	Standard	Replaceable paper element, dual snorkel	
	Optional	--	
Fuel pump	Type (elec. or mech.)	Electric - dual turbine	
	Location (eng., tank)	In fuel tank	
	Pressure range [kPa (psi)]		

Fuel Tank

Capacity [refill L (gallons)]		75.7 (20.0)
Location (describe)		Under rear deck
Attachment		Rests on rear frame extension, held with straps
Material & Mass [kg (weight lbs)]		Super ferne coated steel with high density polyethylene liner(*)
Filler pipe	Location & material	Center of rear deck
	Connection to tank	Bolted with gasket on top of tank
Fuel line (material)		Super ferne coated steel
Fuel hose (material)		Viton
Return line (material)		Super ferne coated steel
Vapor line (material)		Super ferne coated steel
Extended range tank	Opt., n.a.	Not available
	Capacity [L (gallons)]	--
	Location & material	--
	Attachment	--
Auxiliary tank	Opt., n.a.	Not available
	Capacity [L (gallons)]	--
	Location & material	--
	Attachment	--
	Selector switch or valve	--
Separate fill		--

(*) - 13.600 kg. (30.0 lbs.)

MVMA Specifications Form Passenger Car

METRIC (U.S. Customary)

Car Line CORVETTE
 Model Year 1987 Issued 6-86 Revised (●) 9-86

Engine Description/Carb.
Engine Code

5.7 Liter V8 (350 CID)
 Tuned-Port Fuel Injection (TPI)
 RPO L98

Vehicle Emission Control

Exhaust Emission Control	Type (air injection, engine modifications, other)		Air injection w/Computer Command Control	
	Air Injection	Pump or pulse	Vane	
		Driven by	Serpentine - single belt poly 'V' drive	
		Air distribution (head, manifold, etc.)	Exhaust manifold and converter (CCC controlled)	
		Point of entry	Exhaust manifold ports	
	Exhaust Gas Recirculation	Type (controlled flow, open orifice, other)		Controlled flow
		Exhaust source		Inlet manifold exhaust cross-over passage#
		Point of exhaust injection (spacer, carburetor, manifold, other)		Center of inlet manifold plenum
	Catalytic Converter	Type		Platinum-Palladium, and Rhodium, dual-bed
		Number of		Two front and one rear
Location(s)		Front - one on each exhaust pipe Rear - underbody tunnel below console		
Volume [L (in ³)]		2.7822 (169.8)		
Substrate type		Monolith		
Crankcase Emission Control	Type (ventilates to atmosphere, induction system, other)		Induction system	
	Energy source (manifold vacuum, carburetor, other)		Manifold vacuum	
	Discharges (to intake manifold, other)		Inlet manifold	
	Air inlet (breather cap, other)		Air cleaner	
Evaporative Emission Control	Vapor vented to (crankcase, canister, other)	Fuel tank	Canister	
		Carburetor	--	
	Vapor storage provision		Canister	
Electronic system	Closed loop (yes/no)		Yes	
	Open loop (yes/no)		No	

Engine - Exhaust System

Type (single, single with cross-over, dual, other)		Dual
**	Muffler no. & type (reverse flow, straight thru, separate resonator) Material & Mass (kg (weight lbs))	Two, reverse flow (Stainless steel body, aluminum coated steel inlet and outlets)
	Resonator no. & type	None
Exhaust pipe	Branch o.d., wall thickness	Otr pipe 63.5x.96(2.50x.038), inr pipe 57.0x.96(2.25x.038)
	Main o.d., wall thickness	76.2 x 1.83 (3.0 x .072)
	Material & Mass (kg (weight lbs))	Stainless steel tubing (*)
**	Intermediate pipe	o.d. & wall thickness 57.15 x 1.83 (2.25 x .072) Material & Mass (kg (weight lbs)) Aluminum coated steel
**	Tail pipe	o.d. & wall thickness Dual outlets - 57.15 x 1.83 (2.25 x .072) Material & Mass (kg (weight lbs)) Aluminum coated steel

(*) - 2.29 (.09) air gap between pipes for heat control and sound dampening.
 (**) - Muffler & tail pipe unit L.H. 6.565 (14.5)
 R.H. 6.565 (14.5)

MVMA Specifications Form Passenger Car

Car Line CORVETTE
 Model Year 1987 Issued 6-86 Revised (#) 9-86

METRIC (U.S. Customary)

Engine Description/Carb.
Engine Code

5.7 Liter V8 (350 CID)
 Tuned-Port Fuel Injection (TPI)
 RPO L98

Transmissions/Transaxle

Manual 3-speed (std., opt., n.a.) (mfr.)	Not available
Manual 4-speed (std., opt., n.a.) (mfr.)	Optional
Manual 5-speed (std., opt., n.a.) (mfr.)	Not available
Manual overdrive (std., opt., n.a.) (mfr.)	Not available
Automatic (std., opt., n.a.) (mfr.)	Standard
Automatic overdrive (std., opt., n.a.) (mfr.)	Standard

Manual Transmission/Transaxle RPO-MH5-Base & RPO-MK2 + Z51

Number of forward speeds	4 in direct drive, 3 in overdrive*		
Transmission ratios	In first	2.88	
	In second	1.91 direct; 1.30 overdrive	
	In third	1.34 direct; 0.91 overdrive	
	In fourth	1.00 direct; 0.68 overdrive	
	In fifth	--	
	In overdrive	0.68	
	In reverse	2.78	
Synchronous meshing (specify gears)	All Forward		
Shift lever location	Floor		
Lubricant	Capacity (L (pt.))	1.0L (2.1), (1.63L (3.45) for overdrive unit)	
	Type recommended	GL-5 (Dextron II for overdrive unit)	
	SAE viscosity number:	Summer	SAE-80W, SAE-80W-90
		Winter	SAE-80W, SAE-80W-90
	Extreme cold	SAE-80W	

Clutch (Manual Transmission)

Make, type, engagement (describe) - (hydraulic, cable, rod)	Borg & Beck, hydraulically activated slave cylinder; automatic adjustment.	
Assist (yes, no percent)	No	
Type pressure plate springs	Bellville	
Total spring load (N (lb.))	10,230 (2300)	
No. of clutch driven discs	One	
Clutch facing	Material	Non-asbestos
	Manufacturer	Valeo
	Part number	F-202
	Rivets plate	32
	Rivet size	5.41 x 3.63 (.213 x .143)
	Outside & inside dia	273.05 x 165.10 (10.75 x 6.5)
	Total eff. area (cm ² (in. ²))	344.5 (53.4)
Thickness	7.75 (0.305)	
Engagement cushion method	Driven plate, cushion springs	
Release bearing	Type & method of lubrication Ball thrust - prepacked and sealed	
Torsional damping	Method: springs, friction material Coil springs and metal-to-metal friction	

* - Planetary gear set overdrive controlled by on-board computer.

MVMA Specifications Form Passenger Car

Car Line CORVETTE
 Model Year 1987 Issued 6-86 Revised (•) 9-86

METRIC (U.S. Customary)

Engine Description/Carb.
Engine Code

5.7 Liter V8 (350 CID)
Tuned Port Fuel Injection
RPO L98

Automatic Transmission/Transaxle

Trade name		4-Speed Automatic (overdrive 4th gear)
Type and special features (describe)		Torque converter with planetary gears
Selector	Location	Floor mounted in console
	Ltr./No. designation	PRN D D21
Gear ratios	1st	3.06
	2nd	1.63@
	3rd	1.00@
	4th	0.70@
	Reverse	2.29@
Max. upshift speed - drive range (km/h (mph))		1-2=43 MPH, 2-3=79 MPH, 3-4=116 MPH (at wide open throttle)
Max. kickdown speed - drive range (km/h (mph))		4-3=105 MPH, 3-2=72 MPH, 2-1=35 MPH
Min. overdrive speed (km/h (mph))		38 MPH
Torque converter	Number of elements	3
	Max. ratio at stall	1.85
	Type of cooling (air, liquid)	Liquid
	Nominal diameter	298 (11.75)
Lubricant	Capacity (refill L (pt.))	3.8 (8.0)
	Type Recommended	Dexron II
Oil cooler (std., opt., NA, internal, external, air, liquid)		Standard, external, liquid

@ - Computer controlled torque converter clutch 2nd, 3rd and 4th gears.

Axle or Front Wheel Drive Unit

Type (front, rear)		Rear	
Description		Overhung pinion gear	
Limited slip differential (type)		Standard - disc clutches	
Drive pinion offset		38.1 (1.50), 216mm ring gear; 28.6 (1.125), 200mm ring gear	
Drive pinion (type)		Hypoid	
No. of differential pinions		Two	
Pinion / differential adjustment (shim, other)		Shim	
Pinion / differential bearing adjustment (shim, other)		Shim	
Driving wheel bearing (type)		Tapered roller	
Lubricant	Capacity (L (pt.))		1.8 (3.75)
	Type recommended		GL-5 Gear Lubricant
	SAE viscosity number	Summer	80W or 80W-90
		Winter	80W or 80W-90
		Extreme cold	80W or 80W-90

Axle or Transaxle Ratio and Tooth Combinations (See 'Power Teams' for axle ratio usage.)

Axle ratio (or overall top gear ratio)		3.07:1	2.59:1	3.07:1
No. of teeth	Pinion	14	17	14
	Ring gear or gear	43	44	43
Ring gear o.d.		200 (7-7/8)	200 (7-3/8)	216 (8-1/2)2
Transaxle	Transfer gear ratio	--		
	Final drive ratio	--		

MVMA Specifications Form
Passenger Car
METRIC (U.S. Customary)

Car Line CORVETTE
 Model Year 1987 Issued 6-86 Revised (•) _____

Engine Description/Carb.
 Engine Code

5.7 Liter V8 (350 CID)
 Tuned-Port Fuel Injection (TPI)
 RPO L98

Propeller Shaft – Rear Wheel Drive

Manufacturer Type (straight tube, tube-in-tube, internal-external damper, etc.)		Straight Tube, internal-external damper		
Outer diam. x length* x wall thickness	Manual 3-speed trans.	Not available		
	Manual 4-speed trans. with auto overdrive	Aluminum 76.2 x 805.2 x 3.05 (3.00 x 31.7 x 0.12)		
	Manual 5-speed trans.	Not available		
	Overdrive	See manual 4-speed		
	Automatic transmission **	Steel 63.5 x 825.5 x 1.65 (2.50 x 32.5 x .065)	Alum. 76.2 x 825.5 x 3.05 (3.00 x 32.5 x 0.12)	Opt(RPO-Z51) & Power Seat
Inter- mediate bearing	Type (plain, anti-friction)	None		
	Lubrication (fitting, prepack)	--		
Slip yoke	Type	Splined Yoke		
	Number of teeth	Automatic and manual transmissions - 26		
	Spline o.d.	Automatic and manual transmissions 29.7 (1.17)		
Universal joints	Make and mfg. no.	Front	#1311	
		Rear	#1318	
	Number used	Two		
	Type (ball and trunnion, cross)	Cross		
	Rear attach (u-bolt, clamp, etc.)	Strap and Bolt		
	Bearing	Type (plain, anti-friction)	Anti-Friction	
Lubrication (fitting, prepack)		Prepack		
Drive taken through (torque tube, arms or springs)		Torque control arms		
Torque taken through (torque tube, arms or springs)		Torque control arms		

* Centerline to centerline of universal joints, or to centerline of rear attachment.

** - Aluminum, except steel with automatic transmission without power seat (RPO-AG9).

MVMA Specifications Form Passenger Car

Car Line CORVETTE
 Model Year 1987 Issued 6-86 Revised (•) _____

METRIC (U.S. Customary)

Body Type And/Or
Engine Displacement

2-Door Hatchback Coupe 1YY07	2-Door Convertible 1YY67
------------------------------------	--------------------------------

Suspension - General

Car leveling	Std./opt./n.a.	Not available
	Type (air, hyd., etc.)	--
	Manual/auto. controlled	--
Provision for brake dip control		Frt susp geometry-upper arms pos to produce 46% anti-dive
Provision for accel. squat control		Rr susp geometry-control arms pos to produce 62% anti-squat
Provisions for car jacking		Place jack head between locator triangles on rocker flange nearest to wheel being changed.
Shock absorber (front & rear)	Type	Base-Direct double acting hydraulic w/pliacell expansion bags; Optional gas press
	Make	Base-Delco; Opt.-Bilstein
	Piston diameter	Front: Base-25.0 (1.0), Z51&FG3-36 (1.42)(*)
	Rod diameter	Base-12.4 (.49), Z51&FG3-11.0 (.43)

Suspension - Front

Type and description		Independent SLA Forged aluminum upper and lower control arms and steering knuckle, transverse monoleaf spring and steel stabilizer, spindle offset.
Travel	Full jounce	92.0 mm (3.6 in.)
	Full rebound	95.0 mm (3.7 in.)
Spring	Type (coil, leaf, other) & material	Monoleaf, filament wound glass-epoxy composite
	Insulators (type & material)	Pivot; Teflon-filled nylon and alumn., enclosed in rubber.
	Size (coil design height & i.d., bar length x dia.)	1160.0 x 100.0 x 13.22 base, 14.3-Z51 (45.7 x 3.9 x 0.52 base), (0.56-Z51)
	Spring rate [N/mm (lb./in.)]	Base 51.8 (296.0), Z51-66.5 (380.0) → Z52 coupe 51.8 N/mm
	Rate at wheel [N/mm (lb./in.)]	Base 16.2 (92.6), Z51-19.4 (110.9) → Z52 conv. 54.5 N/mm
Stabilizer	Type (link, linkless, frameless)	Link
	Material & bar diameter	HR steel; 24 mm (0.9 in.) dia.-base, 30 mm (1.2 in.) Z51

Suspension - Rear

Type and description		Independent 5-link design with toe and camber adjustment, forged aluminum control arms, knuckles and struts; transverse monoleaf spring steel tie rods & stabilizer. Tubular U-jointed driveshafts, alumn. except with Automatic.
Travel	Full jounce	91.0 mm (3.6 in)
	Full rebound	72.0 mm (2.8 in)
Spring	Type (coil, leaf, other) & material	Monoleaf, filament wound glass-epoxy composite
	Size (length x width, coil design height & i.d., bar length & dia.)	Base-1236 x 57.0 x 22.2, Z51-25.0 (Base 48.7 x 2.24 x 0.87), (Z51-0.98)
	Spring rate [N/mm (lb./in.)]	Base 40.8 (233.0), Z51-57.8 (330.0) Z52 40 N/mm
	Rate at wheel [N/mm (lb./in.)]	Base 22.8 (130.2), Z51-30.4 (173.6)
	Insulators (type & material)	Dual rubber polyisoprene
	If leaf	No. of leaves
	Shackle (comp. or tens.)	Tension
Stabilizer	Type (link, linkless, frameless)	Link
	Material & bar diameter	HR steel; Base 1.8 mm (0.86 in.), Z-51 22.0 mm (0.87 in.);
Track bar (type)		None painted to protect against corrosion

MVMA Specifications Form Passenger Car

Car Line CORVETTE
Model Year 1987 Issued 6-86 Revised (●) _____

METRIC (U.S. Customary)

Body Type And/Or
Engine Displacement

2-Door Hatchback Coupe 1YY07	2-Door Convertible 1YY67
------------------------------------	--------------------------------

Brakes - Service

Description		Aluminum caliper with nodular iron reaction bracket; pad reaction thru bracket.			
Manufacturer and brake type (std., opt., n.a.)	Front (disc or drum)	Disc with sliding-head caliper, low drag			
	Rear (disc or drum)	Disc with sliding-head caliper, low drag			
Self-adjusting (std., opt., n.a.)		Standard			
Special valving	Type (proportion, delay, metering, other)	Proportioning, Integral with Master Cylinder			
Power brake (std., opt., n.a.)		Standard			
Booster type (remote, integral, vac., hyd., etc.)		Integral; lightweight with tru-bolt reaction system			
Vacuum source (inline, pump, etc.)		Inline (Intake Manifold)			
Vacuum reservoir (volume in. ³)		--			
Vacuum pump-type (elec. gear driven, belt driven, if other so state)		Not Applicable			
Anti-lock device type (std., opt., n.a.) (F/R)		Electronic 4-wheel, 3 channel (standard)			
Effective area [cm ² (in. ²)]*		Front 174.0 (27.0), Rear 117.9 (18.3)			
Gross lining area [cm ² (in. ²)]**(F/R)		Front 174.0 (27.0), Rear 117.9 (18.3)			
Swept area [cm ² (in. ²)]*** (F/R)		Front 622 (96.4), Rear 565 (87.5)			
Rotor	Outerworking diameter	F/R	292 (11.5)/292 (11.5)		
	Inner working diameter	F/R	214 (8.42)/222 (8.75)		
	Thickness	F/R	20 (0.8)/20 (0.8)		
	Matenal & type (vented-solid)	F/R	Vented; front-gray cast iron, rear-damped iron		
Drum	Diameter & width	F/R	Not Applicable		
	Type and material	F/R	Not Applicable		
Wheel cylinder bore		54 (2.1)/40.5 (1.6)			
Master cylinder	Bore/stroke	F/R	21.9 (0.862)/12.5 (0.49), 21.9 (0.862)/12.5 (0.49)		
Pedal arc ratio		3.5:1			
Line pressure at 445 N(100 lb.) pedal load [kPa (psi)]		Front 86.18 (1250), Rear 5516 (800)			
Lining clearance		F/R	Self Adjusting		
Brake lining	Front wheel	Bonded or riveted (rivets-seg.)		Integral Molded	
		Rivet size		--	
		Manufacturer		Japan Brake Industries	
		Lining code*****		CP26	
		Material		Semi-Metallic	
		****	Primary or out-board	132 x 38.6 x 8.6	
		Size	Secondary or in-board	112 x 39.6 x 8.6	
	Shoe thickness (no lining)		5.6 mm (0.22) Backing Plate		
	Rear wheel	Bonded or riveted (rivets-seg.)		Integral Molded	
		Manufacturer		Japan Brake Industries	
		Lining Code*****		CP26	
		Material		Semi-metallic	
		****	Primary or out-board	108 x 35 x 8.6	
		Size	Secondary or in-board	92 x 36 x 8.6	
Shoe thickness (no lining)		5.0 mm (0.2) Backing Plate			

*Excludes rivet holes, grooves, chamfers, etc.

**Includes rivet holes, grooves, chamfers, etc.

***Total swept area for four brakes. (Drum brake: Widest lining contact width for each brake x its contact circumference.)
(Disc brake: Square of Outer Working Dia. minus Square of inner Working Dia. multiplied by Pi/2 for each brake.)

****Size for drum brakes includes length x width x thickness.

*****Manufacturer I.D., catalog or formulation designation and coefficient of friction classification.

MVMA Specifications Form Passenger Car

Car Line CORVETTE
 Model Year 1987 Issued 6-86 Revised (●) _____

METRIC (U.S. Customary)

Body Type And/Or
Engine Displacement

2-Door Hatchback Coupe 1YY07	2-Door Convertible 1YY67
------------------------------------	--------------------------------

Tires And Wheels (Standard)

Tires	Size (load range, ply)		P255/50VR-16 B/W
	Type (bias, radial, etc.)		High speed steel belted radial Eagle VR50 (Goodyear), unidirectional
	Inflation pressure (cold) for recommended max. vehicle load	Front (kPa (psi))	240 (35)
		Rear (kPa (psi))	240 (35)
	Rev./mile—at 70 km/h (45 mph)		472 (760)
Wheels	Type & material		Left-Right alum. alloy road wheels with specific vent design
	Rim (size & flange type)		16 x 8.5 Front, 16 x 8.5 Rear
	Wheel offset		32 mm (1.26)
	Attachment	Type (bolt or stud)	Stud
		Circle diameter	120.7 (4.75)
Number & size		5 Hex nuts, one anti-theft; M12x1.5-6H	
Spare	Tire and wheel (same, if other describe)		P155/80D-16, 16 x 4 steel wheel
	Storage position & location (describe)		Horizontal under fuel tank

Tires And Wheels (Optional)

		*(RPO Z51, Performance Handling Package)	
Size (load range, ply)		*P255/50VR-16 B/W	
Type (bias, radial, etc.)		*High speed steel belted radial Eagle VR50 (Goodyear)	
Wheel (type & material)		*Left-right alum. alloy road wheels with specific vent design	
Rim (size, flange type and offset)		*16x9.5 Front, 16x9.5 Rear/38mm offset	
Size (load range, ply)			
Type (bias, radial, etc.)			
Wheel (type & material)			
Rim (size, flange type and offset)			
Size (load range, ply)			
Type (bias, radial, etc.)			
Wheel (type & material)			
Rim (size, flange type and offset)			
Size (load range, ply)			
Type (bias, radial, etc.)			
Wheel (type & material)			
Rim (size, flange type and offset)			
Spare tire and wheel			
(if configuration is different than road tire or wheel, describe optional spare tire and/or wheel location & storage position)		T155/80D16 (aluminum 16 x 4 wheel with Power Seat Opt. RPO-AG9)	

Brakes - Parking

Type of control		Grip handle control
Location of control		Below the top of door sill, at the driver's left
Operates on		Rear brake drums, integral with disc rotor
If separate from service brakes	Type (internal or external)	Internal, manual duo-servo
	Drum diameter	177 (7.00)
	Lining size (length x width x thickness)	172.2 x 31.8 x 4.44 (6.78 x 1.25 x 0.175)

MVMA Specifications Form Passenger Car

Car make BUICK
Model Year 80? Model Wildcat Revised (-)

METRIC (U.S. Customary)

Body Type And Gr	2-Door	2-Door
Engine Displacement	4-cyl	4-cyl
	1.7	1.7

Steering

Manual (std., opt., n.a.)		Type		Standard	
Power (std., opt., n.a.)		Type		Standard	
Adjustable steering wheel/column (tilt, telescope, other)	Type	Black leather-wrapped two-spoke steering wheel			
	Manufacturer	Ford and Ford's OEM			
	(Std. opt., n.a.)	Standard			
Wheel diameter** (W9) SAE J1100	Manual	Not Available			
	Power	358 (14.1)			
Turning diameter m (ft.)	Outside front	Wall to wall (l. & r.)	12.5 (40.7)		
		Curb to curb (l. & r.)	15.3 (49.9)		
	Inside rear	Wall to wall (l. & r.)	7.6 (25.0)		
		Curb to curb (l. & r.)	7.5 (25.0)		
Scrub Radius*					
Manual	Gear	Type	Not Available		
		Manufacturer	--		
	Ratios	Over	--		
		Under	--		
No. wheel turns (stop to stop)					
Power	Type (coaxial, linkage, etc.)		Alloy Rack and Pinion		
	Manufacturer		Saginaw Steering Gear 11 wt. transverse compact pump		
	Gear	Type	Free Tole		
		Ratios	Gear	Overall	
	Ratio		15.5:1 - Base, 13.0:1 - 2nd Handling Package		
Ratio (overall)		Accessories Bell Driven			
No. wheel turns (stop to stop)		2.36 Turns Base, 1.95 Turns - 2nd Handling Package			
Linkage	Type		Free Tole		
	Location (front or rear of wheel axle)		Front of wheel		
	Tie rods (one or two)		Two		
Steering axis	Inclination at camber (deg.)		8.744°		
	Bearings (type)	Upper	Ball Joint (M/M w/anti-friction washer); anti-corrosive		
		Lower	Ball Joint (M/M w/anti-friction washer); anti-corrosive		
		Thrust	Lower Ball Joint		
Steering spindle & joint type		Upper and lower ball joints; anti-corrosive			
Wheel spindle/hub	Diameter	Inner bearing	51 mm (2.0 in)		
		Outer bearing	51 mm (2.0 in)		
	Thread (size)		Not Available		
	Bearing (type)		Unit hub-bearing assembly with double row balls; anti-corrosive		

*The horizontal distance in the front elevation only between wheel centerline and kingpin (ball joint) axis at ground

**See Page 21

MVMA Specifications Form Passenger Car

Car Line CORVETTE
Model Year 1987 Issued 6-86 Revised (#) _____

METRIC (U.S. Customary)

Body Type And/Or
Engine Displacement

2-Door Hatchback Coupe 1YY07	2-Door Convertible 1YY67
------------------------------------	--------------------------------

Wheel Alignment

Front wheel at curb mass (wt.)	Service checking	Caster (deg.)	6.0°, +/- 0.5°
		Camber (deg.)	0.8°, +/- 0.5°
		Toe-in [outside track-mm (in.)]	0.0°, +/- .10°
	Service reset*	Caster	--
		Camber	--
		Toe-in	--
	Periodic M.V. inspection	Caster	--
		Camber	--
		Toe-in	--
Rear wheel at curb mass (wt.)	Service checking	Camber (deg.)	0°, +/- 0.5°
		Toe-in [outside track-mm (in.)]	0.0°, +/- .1°
	Service reset*	Camber	--
		Toe-in	--
	Periodic M.V. inspection	Camber	--
		Toe-in	--

* Indicates pre-set, adjustable, trend set or other.

Electrical - Instruments and Equipment *

Speedometer	Type (analog, digital, std., opt.)	Electronic liquid crystal-digital and analog
	Trip odometer (std., opt., n.a.)	Standard
EGR maintenance indicator		Not available
Charge indicator	Type	Digital display
	Warning device (light, audible)	Standard-warning indicator and digital read-out
Temperature indicator	Type	Digital display
	Warning device (light, audible)	Standard-warning indicator and digital read-out
Oil pressure indicator	Type	Digital display
	Warning device (light, audible)	Standard-warning indicator and digital read-out
Fuel indicator	Type	Electric liquid crystal-analog
	Warning device (light, audible)	Standard-warning indicator signals-low fuel
Windshield wiper	Type (standard)	Intermittent control system
	Type (optional)	Not available
	Blade length	508 mm (20 in.)
	Swept area [cm ² (in. ²)]	6920 (1072.9)
Windshield washer	Type (standard)	Push button-manual
	Type (optional)	Not available
	Fluid level indicator (light, audible)	Not available
Rear window wiper, wiper/washer (std., opt., n.a.)		
Horn	Type	Vibrator
	Number used	Two

Other Tell-tale lights warning of unfastened seat belts (FASTEN BELTS), low brake line pressure or parking brake on (BRAKE), anti-theft alert (SECURITY), electronic control module malfunction (CHECK ENGINE), door ajar (DOOR AJAR), hatch ajar (HATCH AJAR), 4-speed manual overdrive engaged (OVERDRIVE ENGAGED). Drivers information system mileage range, instant and average MPG, and trip odometer also included as standard equipment.

*English or Metric

MVMA Specifications Form Passenger Car

Car Line CORVETTE
 Model Year 1987 Issued 6-86 Revised (•) _____

METRIC (U.S. Customary)

Engine Description/Carb.
 Engine Code

5.7 Liter V8 (350 CID)
 Tuned-Port Fuel Injection (TPI)
 RPO L98

Electrical – Supply System

Battery	Manufacturer	Delco-Remy
	Model, std., (opt.)	75-630, Standard
	Voltage	12 Volts
	Amps at 0°F cold crank	630 cold cranking amps. (CCA)
	Minutes-reserve capacity	90 minute reserve capacity
	Amp/hrs. - 20 hr. rate	54 Amp-Hrs.
	Location	Engine compartment directly behind left wheel opening
Alternator	Manufacturer	Delco Remy
	Rating	105 Amps
	Ratio (alt. crank/rev.)	3.24:1
	Optional (type & rating)	None
Regulator	Type	Micro circuit unit; integral with alternator

Electrical – Starting System

Start. motor	Current drain at 0°F	350 Amps
Motor drive	Engagement type	Positive shift solenoid
	Pinion engages from (front, rear)	Rear

Electrical – Ignition System

Type	Electronic (std., opt., n.a.)	--	
	Other (specify)	High Energy Ignition (HEI)	
Coil	Make	Delco-Remy	
	Model	Integral with distributor	
	Current	Engine stopped - A	--
		Engine idling - A	--
Spark plug	Make	AC	
	Model	FR3LS	
	Thread (mm)	M14 x 1.25	
	Tightening torque [N·m (lb. ft)]	24-30 (18-22)	
	Gap	0.81 (0.035)	
	Number per cylinder	one	
Distributor	Make	Delco Remy	
	Model		

Electrical – Suppression

Locations & type: Internal alternator capacitor, non-metallic high-tension cables, resistor spark plugs, ignition coil by-pass capacitor, internal AC blower motor by-pass capacitor & A/C compression diode, with radio provisions; hood grounding clip, engine to dash panel ground strap, fuse block capacitor and on "heater only" blower motors and coax capacitor.

MVMA Specifications Form Passenger Car

METRIC (U.S. Customary)

Car Line CORVETTE
Model Year 1987 Issued 6-86 Revised (●) _____

Body Type

2-Door Hatchback Coupe 1YY07	2-Door Convertible 1YY67
------------------------------------	--------------------------------

Body

Structure	Integral perimeter frame-bridgework forms strong unitized body structure. Aerodynamically shaped body with deeply angled windshield (64°), all body panels SMC reinforced composite with molded-in coating. Single lift off roof panel effective pass. compartment insulation tinted glass all around. "Unibase" paint process, final clear coat paint finish.
Bumper system front - rear	Front - full-width honeycomb energy absorber backed up by an impact bar of strong continuous glass fiber plastic. Body color, glass-reinforced rim fascia. rear-similar honeycomb design.
Anti-corrosion treatment	All encompassing corrosion protection including extensive use of aluminum; galvanization; use of specially treated fasteners; austenitic stainless steel or specially coated brackets, clamps, clips and braces; use of aluminized steel, dip painted; use of materials that resist corrosion.

Body - Miscellaneous Information

Type of finish (lacquer, enamel, other)	High solids acrylic enamel with final clear coat	
Hood	Hinge location (front, rear)	Front
	Type (counterbalance, prop)	Hinged clamshell hood, w/upper wheelhouse attached (*)
	Release control (internal, external)	Internal
Trunk lid	Type (counterbalance, other)	--
	Internal release control (elec., mech., n.a.)	--
Hatch-back lid	Type (counterbalance, other)	Dual gas struts
	Internal release control (elec., mech., n.a.)	Electric release, std (each door and console glove box)
Station wagon		
Vent window control (crank, friction, pivot, power)	Front	None
	Rear	None
Seat cushion type (e.g., 60/40, bucket, bench, wire, foam etc.)	Front	Bucket Seat, full cloth trim w/wool pad comfort liner @
	Rear	None
	3rd seat	None
Seat back type (e.g., 60/40, bucket, bench, wire, foam etc.)	Front	Bucket Seat, full cloth trim w/wool pad comfort liner @
	Rear	None
	3rd seat	None

(*) Gives easy access to engine and chassis components; folding prop rod hold open; SMC reinforced composite.

(@) SMC reinforced composite frame for seat cushion and backrest.

MVMA Specifications Form
Passenger Car
METRIC (U.S. Customary)

Car Line CORVETTE
 Model Year 1987 Issued 6-86 Revised (•) _____

Body Type

2-Door Hatchback Coupe 1YY07	2-Door Convertible 1YY67
------------------------------------	--------------------------------

Restraint System

Active restraint system	Standard/optional	Standard
	Type and description	3-Point seat belt system, motion sensitive or locking
	Location	Driver and passenger seat
Passive seat belts	Standard/optional	Not Applicable
	Power/manual	"
	2 or 3 point	"
	Knee bar/lap belt	"

Frame

Type and description (separate frame, unitized frame, partially-unitized frame)	All-welded steel body-frame construction, 100% galvanized. Bolt-on front crossmember to allow bottom loaded engine.
---	---

Glass	SAE Ref. No.		
Windshield glass exposed surface area [cm ² (in. ²)]	S1	8710.0 (1350.0)	
Side glass exposed surface area [cm ² (in. ²)] - total 2-sides	S2	4007.2 (621.1)	
Backlight glass exposed surface area [cm ² (in. ²)]	S3	6205.0 (961.8)	2554.8 (396.0)
Total glass exposed surface area [cm ² (in. ²)]	S4	18922.2 (2932.9)	15272.0 (2367.1)
Windshield glass (type)		Curved - Laminated Plate - Tinted	
Side glass (type)		Curved - Tempered Plate - Tinted	
Backlight glass (type)		Curved - Tempered Plate - Tinted	

MVMA Specifications Form
Passenger Car
METRIC (U.S. Customary)

Car Line CORVETTE
 Model Year 1987 Issued 6-86 Revised (#) _____

Body Type

2-Door Hatchback Coupe 1YY07	2-Door Convertible 1YY67
------------------------------------	--------------------------------

Convenience Equipment (standard, optional, n.a.)

Air conditioning (manual, auto, temp control)	Standard, four season manual control	
Clock (digital, analog)	Standard, digital read-out with all radios	
Compass thermometer	Not Available	
Console (floor, overhead)	Standard, Floor	
Defroster, elec. backlight	Optional (with heated side view mirrors) Not Available	
Electronic	Diagnostic monitor (integrated, individual)	STD.-ALCL (Assembly Line Communications Link); Integrated
	Instrument cluster (list instruments)	Speedo, Tach, Oil & Coolant Temps, Oil Press, Volts, Fuel
	Keyless entry	Not Available
	Tripminder (avg. spd., fuel)	Range, average and instant MPG
	Voice alert (list items)	Not Available
	Other	LCD and digital instrumentation standard
Fuel door lock (remote, key, electric)	Not Available	
Lamps	Auto head on / off delay, dimming	Not Available
	Coming	Front and rear, standard
	Courtesy (map, reading)	Std - one lamp in each door pnl. Mounted on I/S R/V mirror
	Door lock, ignition	Std. - inside door lock-door open, delay when closed
	Engine compartment	Standard
	Fog	Standard
	Glove compartment	Standard - in console
	Trunk	Std - two lamps mounted in 'B' pillars Back of seat divider
	Other	Interior lamps delay - standard
		--
Mirrors	Day night (auto, man.)	Standard, manual
	LH (remote, power, heated)	Power standard, heated optional
	RH (convex, remote, power, heated)	Power standard, heated optional
	Door vanity (RH / LH, illuminated)	RH standard/LH optional
Parking brake-auto release (warning light)	Manual release, telltale-std.	
Power equipment	Door locks - deck lid - specify	Standard deck lid (hatch), optional door locks
	Seat (2-4-6 way) heated (driver, pass, other) lumbar, hip, thigh support (power, manual) reclining (driver, pass) memory (1-2 preset, recline)	Power 6-way driver's seat - optional; Passenger optional Power custom seat (lumbar, reclining, backrest lateral restraints) - optional
	Side windows	Standard
	Vent windows	Not Available
	Rear window	Standard - electric hatch release (3 remote locations)
	Convertible deck lid	Standard
Radio systems	Antenna (location, whip, w/shield, power)	Rear power antenna
	AM, FM, stereo, tape, CB	AM/FM stereo std; AM/FM stereo cass, AM/FM stereo cass/Bose
	Speaker (number, location) Premium sound	Except Bose-2 frt, 2 rr; Bose-each door, 2 rr
Roof open air fixed (flip-up, sliding, "T")	Single, full width lift-off roof panel Conv folding top	
Speed control device	Opt-electronic speed & cruise control w/resume feature	
Speed warning device (light, buzzer, etc.)	Not available	
Tachometer (rpm)	6000 RPM	
Telephone system - mobile		

New "vats" system includes special module with resistor decoder and ignition key with embedded pellets of specified resistance. Built-in time lag, forces delay between attempts to start vehicle with improper key. Also includes anti-theft horn alarm system with starter interrupt (doors and hatch)

MVMA Specifications Form

Car Line CORVETTE

Model Year 1987

Issued 6-86

Revised (e) _____

Passenger Car

METRIC (U.S. Customary)

Car and Body Dimensions See Key Sheets for definitions

All dimensions to ground are for comparative purposes only. Dimensions are to be shown for all base body models of each car line. SAE Ref. no. refers to the definition published in SAE Recommended Practice J1100 "Motor Vehicle Dimensions," unless otherwise specified.

Body Type	SAE Ref. No.	2-Door Hatchback Coupe 1YY07	2-Door Convertible 1YY67
	Width		

Tread (front)	W101	1513 (59.6)
Tread (rear)	W102	1534 (60.4)
Vehicle width	W103	1804 (71.0)
Body width at Sg RP (front)	W117	1752 (69.0)
Vehicle width (front doors open)	W120	3706 (145.9)
Vehicle width (rear doors open)	W121	--
Front fender overall width	W108	1743 (68.6)
Rear fender overall width	W107	1779 (70.0)
Tumble-home (deg.)	W122	36.9°

Length

Wheelbase	L101	2444 (96.2)
Vehicle length	L103	4483 (176.5)
Overhang (front)	L104	1030 (40.5)
Overhang (rear)	L105	1009 (39.7)
Upper structure length	L123	2309 (90.9)
Rear wheel C/L "X" coordinate	L127	1886 (74.2)
Cowl point "X" coordinate	L125	174 (6.9)
Front end length at centerline	L126	1761 (69.3)
Rear end length at centerline	L129	360 (14.2)

Height **

Passenger distribution (front/rear)	PD1.2.3		**
Trunk/cargo load			**
Vehicle height	H101	1186 (46.7)	1179 (46.4)
Cowl point to ground	H114	845 (33.4)	
Deck point to ground	H138		
Rocker panel-front to ground	H112	175 (6.9)	
Bottom of door closed-front to grd.	H133	255 (10.1)	
Rocker panel-rear to ground	H111	175 (6.9)	
Bottom of door closed-rear to grd.	H135	--	
Windshield slope angle	H122	64.7	
Backlight slope angle	H121	72.5	

Ground Clearance **

Front bumper to ground	H102	124 (4.9)
Rear bumper to ground	H104	330 (13.0)
Bumper to ground (front at curb mass (wt.))	H103	130 (5.1)
Bumper to ground (rear at curb mass (wt.))	H105	353 (13.9)
Angle of approach (degrees)	H106	10.6°
Angle of departure (degrees)	H107	20.2°
Ramp breakover angle (degrees)	H147	12.3°
Axle differential to ground (front / rear)	H153	172 (6.8)
Min. running ground clearance	H156	120 (4.7)
Location of min. run. grd. clear.		Catalytic Converter

**All Vehicle Height And Ground Clearances Are Made Using EPA Loaded Vehicle Weight, Loading Conditions.

EPA LOADED VEHICLE WEIGHT is The Base Vehicle Weight Plus All Coolant And Fluids Necessary For Operation Plus 100% Of The Fuel Capacity, Plus The Weight Of All Options And Accessories Which Weigh Three Pounds Or More And Which Are Sold On At Least 33% Of The Car Line, Plus Two Occupants.

MVMA Specifications Form

Passenger Car

METRIC (U.S. Customary)

Car and Body Dimensions

See Key Sheets for definitions

Car Line CORVETTE

Model Year 1987

Issued 6-86

Revised (•) 9-86

Body Type

SAE Ref. No.	2-Door Hatchback Coupe 1YY07	2-Door Convertible 1YY67
--------------	---------------------------------	-----------------------------

Front Compartment

Sg RP front, "X" coordinate	L31	1150 (45.3)	
Effective head room	H61	926 (36.4)	927 (36.5)
Max. eff. leg room (accelerator)	L34	1083 (42.6)	
SgRP to heel point	H30	188 (7.4)	
SgRP to heel point	L53	898 (35.4)	
Back angle	L40	28.0	
Hip angle	L42	98.0	
Knee angle	L44	130.0	
Foot angle	L46	87.0	
Design H-point front travel	L17	146 (5.7)	
Normal driving & riding seat track trvl.	L23	146 (5.7)	
Shoulder room	W3	1373 (54.1)	
Hip room	W5	1253 (49.3)	
** Upper body opening to ground	H50	1092 (43.0)	
Steering wheel maximum diameter	W9	368 (14.5)	
Steering wheel angle	H18	18.4	
Accel. heel pt. to steer. whl. cntr	L11		
Accel. heel pt. to steer. whl. cntr	H17		
Steering wheel to C/L of thigh	H13	84 (3.3)	
Steering wheel torso clearance	L7	390 (15.4)	
Headlining to roof panel (front)	H37	10 (0.4)	
Undepressed floor covering thickness	H67	24 (0.9)	

All Interior Dimensions Are Measured With The Seating Reference Point (SgRP) Full Rear And mm Upward Of Rearmost Seat Position.

Rear Compartment

Sg RP Point couple distance	L50		
Effective head room	H63	NOT	
Min. effective leg room	L51		
Sg RP (second to heel)	H31	APPLICABLE	
Knee clearance	L48		
Compartment room	L3		
Shoulder room	W4		
Hip room	W6		
** Upper body opening to ground	H51		
Back angle	L41		
Hip angle	L43		
Knee angle	L45		
Foot angle	L47		
Headlining to roof panel (second)	H38		
Depressed floor covering thickness	H73		

Luggage Compartment

Usable luggage capacity [L. (cu. ft.)]	V1	--	186.9 (6.6)
** Litter height	H195	902 (35.5)	

Interior Volumes (EPA Classification)

Vehicle class (subcompact, compact, etc.)		Mini-compact
Interior volume index (cu. ft.)		Not available, on two passenger vehicles
Trunk/cargo index (cu. ft.)		--

All linear dimensions are in millimeters (inches).

** EPA Loaded Vehicle Weight, Loading Conditions

MVMA Specifications Form

Passenger Car

METRIC (U.S. Customary)

Car and Body Dimensions See Key Sheets for definitions

Car Line CORVETTE

Model Year 1987

Issued 6-86

Revised (●) 10-86

Body Type

SAE Ref. No.	2-Door Hatchback Coupe 1YY07
--------------	------------------------------------

Station Wagon - Third Seat

Sg RP couple distance	L85	NOT
Shoulder room	W85	APPLICABLE
Hip room	W86	
Effective leg room	L86	
Effective head room	H86	
Sg RP to heel point	H87	
Knee clearance	L87	
Seat facing direction	SD1	
Back angle	L88	
Hip angle	L89	
Knee angle	L90	
Foot angle	L91	

Station Wagon - Cargo Space

Cargo length (open front)	L200	NOT
Cargo length (open second)	L201	APPLICABLE
Cargo length (closed front)	L202	
Cargo length (closed second)	L203	
Cargo length at belt (front)	L204	
Cargo length at belt (second)	L205	
Cargo width (wheelhouse)	W201	
Rear opening width at floor	W203	
Opening width at belt	W204	
Max rear opening width above belt	W205	
Cargo height	H201	
Rear opening height	H202	
Tailgate to ground height	H250	
Front seat back to load floor height	H197	
Cargo volume index [m ³ (ft. ³)]	V2	
Hidden cargo volume [m ³ (ft. ³)]	V4	
Cargo volume index-rear of 2-seat	V10	

Hatchback - Cargo Space

Cargo length at front seatback height	L208	792 (31.2)
Cargo length at floor (front)	L209	838 (33.0)
Cargo length at second seatback height	L210	
Cargo length at floor (second)	L211	
Front seatback to load floor height	H197	454 (17.9)
Second seatback to load floor height	H198	
Cargo volume index [m ³ (ft. ³)]	V3	508L (17.9)
Hidden cargo volume [m ³ (ft. ³)]	V4	--
Cargo volume index-rear of 2-seat	V11	--

Aerodynamics*

Wheel lip to ground, front	685 (27.0)
Wheel lip to ground, rear	695 (27.4)
Frontal area [m ² (ft. ²)]	1.80(19.4)
Drag coefficient (Cd)	

* EPA Loaded Vehicle Weight, Loading Conditions
All linear dimensions are in millimeters (inches) unless otherwise noted.

MVMA Specifications Form
Passenger Car
METRIC (U.S. Customary)

Car Line CORVETTE
 Model Year 1987 Issued 6-86 Revised (e) 9-86

Body Type	2-Door Hatchback Coupe 1YY07	2-Door Convertible 1YY67

Vehicle Fiducial Marks

Fiducial Mark Number	Define Coordinate Location
Front	X - Fiducial mark to vertical base grid line - front, measured horizontally from the base grid line to the front fiducial mark located on top of the front seat adjuster mounting bolt.
	Y - Fiducial mark to centerline of car - front, width measurement made from centerline of car to the fiducial mark located on top of the front seat adjuster mounting bolt.
	Z - Fiducial mark to horizontal base grid line - front, measured vertically from base grid line to front fiducial mark located on top of the front seat adjuster mounting bolt.
Rear	X - Fiducial mark to vertical base grid line - rear, measured horizontally from base grid line to the rear fiducial mark located on the rail (compartment pan - longitudinal).
	Y - Fiducial mark to centerline of car - rear, width measurement made from centerline of car to fiducial mark located on the rail (compartment pan - longitudinal).
	Z - Fiducial mark to horizontal base grid line - rear, measured vertically from base grid line to the rear fiducial mark located on the rail (compartment pan - longitudinal).
Front	W21 552 (21.7)
	L54 831 (32.7)*
	H81 -181 (-7.1)#
	H161 178 (7.0)
	** H163 120 (4.7)
Rear	W22 296 (11.7)
	L55 2714 (106.9)*
	H82 46 (1.8)#
	H162 367 (14.4)
	** H164 345 (13.6)
	* Vertical base grid 2000 mm line # Horizontal base grid 500 mm line

* Reference - SAE Recommended Practice, J182, Motor Vehicle Fiducial Marks.
 All linear dimensions are in millimeters (inches).
 ** EPA Loaded Vehicle Weight, Loading Conditions

MVMA Specifications Form
Passenger Car
METRIC (U.S. Customary)

Car Line CORVETTE
 Model Year 1987 Issued 6-86 Revised (●) _____

Body Type	2-Door Hatchback Coupe 1YY07	2-Door Convertible 1YY67
-----------	------------------------------------	--------------------------------

Lamps and Headlamp Shape*

Height above ground to center of bulb or marker	Headlamp (SAE - H127)	Highest**	660.1 (26.0)
		Lowest	--
	Taillamp (SAE - H128)	Highest**	760.6 (29.9)
		Lowest	758.2 (29.8)
	Sidemarker	Front	472.1 (18.6)
		Rear	551.0 (21.7)
Distance from C-L of car to center of bulb	Headlamp	Inside	--
		Outside**	544.0 (21.4)
	Taillamp	Inside	410.1 (16.1)
		Outside**	625.1 (24.6)
	Directional	Front	485.0 (19.1)
		Rear	625.1 (24.6)
Halogen headlamp (std., opt., n.a.)	Lo beam	Standard	
	Hi beam	Standard	
	Replaceable bulb	Sealed beam, entire unit replaced	
	Shape	Rectangular	
Headlamp other than above	Lo beam	Not Available	
	Hi beam	"	"
	Replaceable	"	"
	Shape	"	"
	Type	"	"

* Measured at curb mass (weight).
 ** If single lamps are used enter here.
 All linear dimensions are in millimeters (inches) unless otherwise noted.

MVMA Specifications Form
Passenger Car

Car Line CORVETTE
Model Year 1987 Issued 6-86 Revised (e) 9-86

METRIC (U.S. Customary)

Model	Vehicle Mass (weight)							SHIPPING MASS, kg (weight, lb)**
	CURB MASS, kg. (weight, lb.)*			% PASS. MASS DISTRIBUTION				
	Front	Rear	Total	Pass In Front		Pass In Rear		
				Front	Rear	Front	Rear	
2-Door Hatchback	737.2	727.6	1464.8					1417.6
Coupe 1YY07	(1625)	(1604)	(3229)					(3125)
2-Door Convertible	749.6	746.9	1496.5					1449.3
1YY67	(1652)	(1647)	(3299)					(3195)
Curb Weight - The calculated weight of a vehicle with standard equipment, only as designed with the additional load of oils, lube, coolant and fuel filled to capacity.								
Shipping Weight - Same as base curb weight except only 3 gallons of gasoline.								

* Reference - SAE J1100 Motor vehicle dimensions, curb weight definition.
** Shipping mass (weight) definition -

MVMA Specifications Form

Passenger Car

Car Line CORVETTE
 Model Year 1987 Issued 6-86 Revised (●) _____

METRIC (U.S. Customary)

Equipment	Optional Equipment Differential Mass (weight)*			Remarks
	MASS. kg. (weight, lb.)			
	Front	Rear	Total	
Custom Adjustable Sport Seats RPO AQ9	3.4 (7.5)	4.0 (8.8)	7.4 (16.3)	Power adjust for backrest lateral restraints, lumbar support and back angle, special cloth trim.
Power Door Lock System RPO AU3	.4 (0.9)	.4 (0.9)	.8 (1.8)	
Leather Seat Trim RPO B16	.6 (1.3)	1.0 (2.2)	1.6 (3.5)	A51 required (special contour bucket seat).
Removable Plastic Roof Panel RPO CC3	-.4 (-0.9)	-1.4 (-3.1)	-1.8 (-4.0)	Acrylic plastic. Lighter, blue tinted for glare and sun load control, coated for scratch resistance./Not available on convertible.
Automatic Speed Control w/Resume Speed RPO K34	1.0 (2.3)	.2 (0.4)	1.2 (2.6)	With manual or automatic transmissions.
Radio Delete RPO UL5	-2.4 (-5.3)	-2.6 (-5.7)	-5.0 (-11.0)	
Radio AM/FM Stereo (ETR) with Cassette Player RPO UM6	.2 (0.4)	.2 (0.4)	.4 (0.8)	Includes power rear antenna plus two front and two rear speakers.
Custom Two-Tone Paint RPO D84	.2 (.4)	.2 (.4)	.4 (.9)	
Automatic Transmission RPO MDS	4.6 (10.1)	1.6 (3.5)	6.2 (13.6)	

*Also see Engine - General Section for dressed engine mass (weight).

MVMA Specifications Form Passenger Car

Car Line CORVETTE
 Model Year 1987 Issued 6-86 Revised (•) _____

METRIC (U.S. Customary)

Equipment	Optional Equipment Differential Mass (weight)*			Remarks
	MASS, kg. (weight, lb.)			
	Front	Rear	Total	
Delco/Bose Premium Audio System RPO UU8	2.0 (4.4)	5.0 (11.0)	7.0 (15.4)	Includes specific AM/FM stereo radio with cassette player. Bose power amplified, direct reflecting speakers (one in each door and at each side of luggage area). Also features Dolby sound, dynamic noise reduction and automatic suppression system.
Heavy Duty Cooling RPO V08	2.8 (6.2)	-.6 (-1.3)	2.2 (4.9)	Includes HD radiator, aux. boost fan, and oil cooler.
Electric Defogger System (Hatch and outside rear view mirrors) RPO Z6A	.2 (0.4)	.2 (0.4)	.4 (0.8)	Mirrors only on convertible.
Performance Handling Package, consists of FE7, FG3, GZ0, VO1, KC4, B4P RPO Z51	11.4 (25.1)	4.8 (10.6)	16.2 (35.7)	Includes left-right 16 x 9-1/2 wheels, fast steering, HD cooling and 3.07 axle ratio for auto
Automatic Air Conditioning RPO C68	1.0 2.205	--	1.0 2.205	Automatic temperature control

*Also see Engine - General Section for dressed engine mass (weight)

MVMA Specifications Form

Passenger Car

METRIC (U.S. Customary)

Exterior Car And Body Dimensions – Key Sheet

Exterior Width

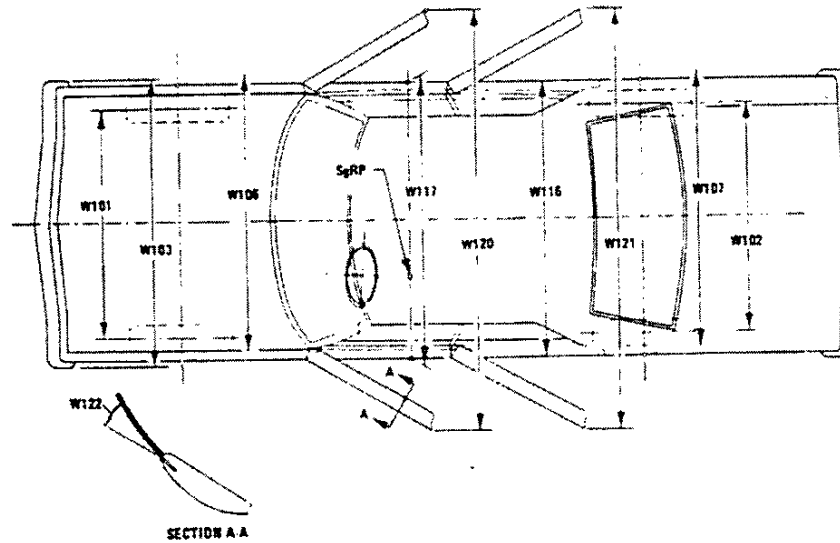

Exterior Length & Height

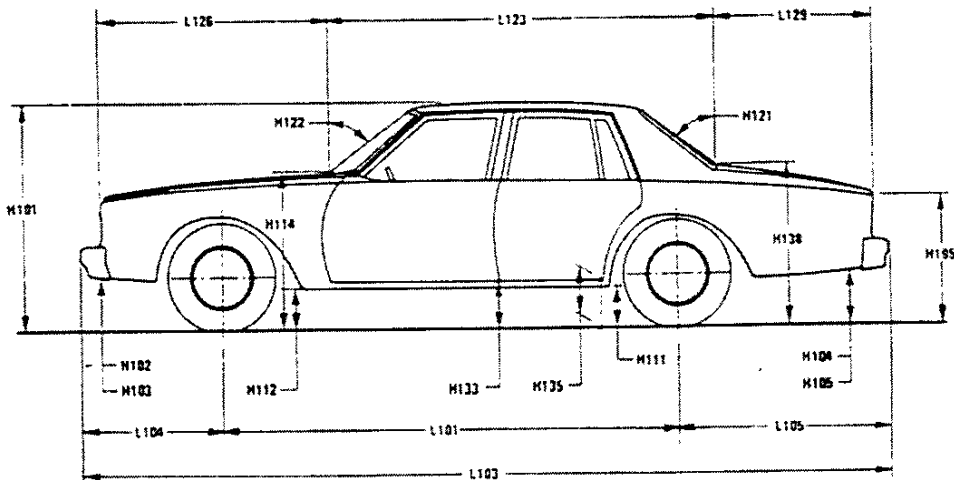

Exterior Ground Clearance

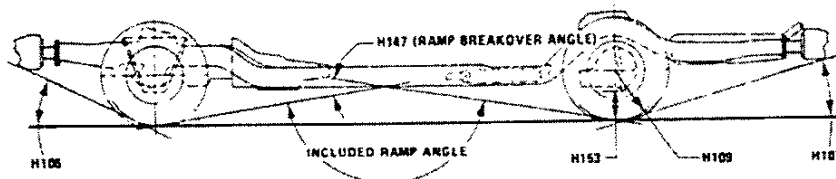

MVMA Specifications Form

Passenger Car

METRIC (U.S. Customary)

Interior Car And Body Dimensions – Key Sheet

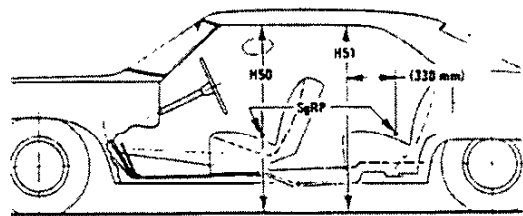
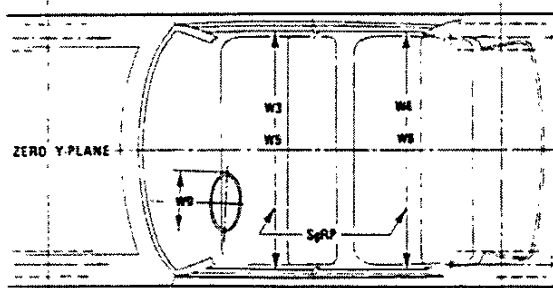
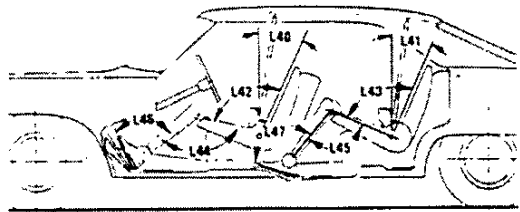
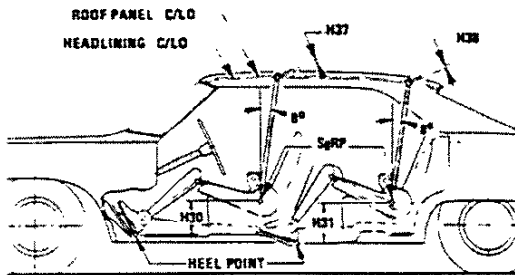
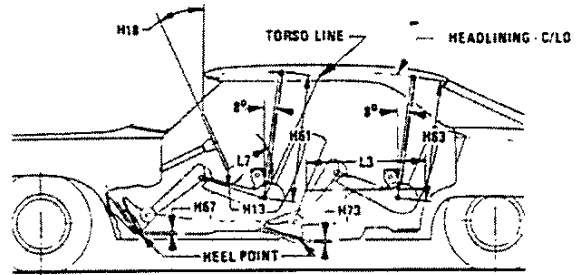
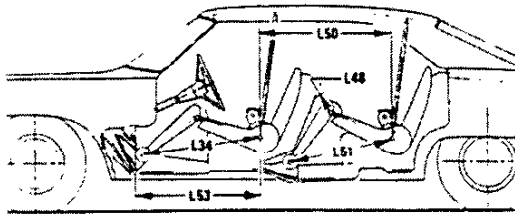

MVMA Specifications Form
Passenger Car
METRIC (U.S. Customary)

Interior Car And Body Dimensions – Key Sheet

Third Seat

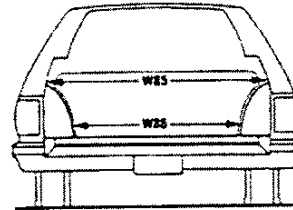
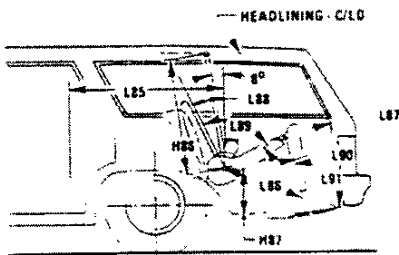

Cargo Space

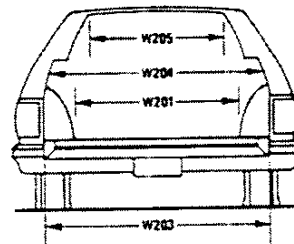
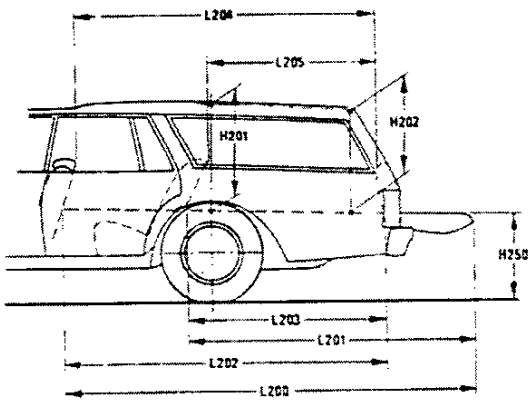

Station Wagon

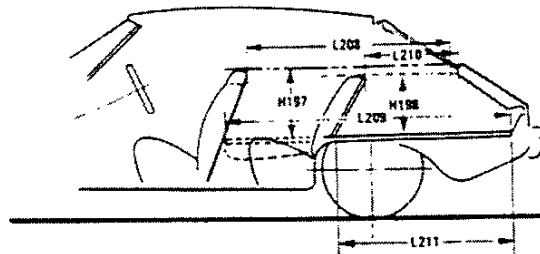

Hatchback

MVMA Specifications Form

Passenger Car

METRIC (U.S. Customary)

Exterior Car And Body Dimensions – Key Sheet

Dimensions Definitions

Seating Reference Point

SEATING REFERENCE POINT means the manufacturer's design reference point which –

- (a) Establishes the rearmost normal design driving or riding position of each designated seating position in a vehicle;
- (b) Has coordinates established relative to the design vehicle structure;
- (c) Simulates the position of the pivot center of the human torso and thigh; and
- (d) Is the reference point employed to position the two dimensional templates described in SAE Recommended Practice J826, "Devices for Use in Defining and Measuring Vehicle Seating Accommodations."

Width Dimensions

- W101 TREAD–FRONT. The dimension measured between the tire centerlines at the ground.
- W102 TREAD–REAR. The dimension measured between the tire centerlines at the ground. In case of dual wheels, the dimension will be measured to the centerline of tire and wheel assemblies.
- W103 VEHICLE WIDTH. The maximum dimension measured between the widest point on the vehicle, excluding exterior mirrors, flexible mud flaps, marker lamps, but including bumpers, moldings, sheet metal protrusions or dual wheels, if standard equipment.
- W106 FRONT FENDER WIDTH. The dimension measured between the widest points at the front wheel centerline, excluding moldings.
- W107 REAR FENDER WIDTH. The dimension measured between the widest points at the rear wheel centerline, excluding moldings.
- W117 BODY WIDTH AT SgRP–FRONT. The dimension measured laterally between the widest points on the body at the SgRP–front, excluding door handles, applied moldings, or appendages.
- W120 VEHICLE WIDTH–FRONT DOORS OPEN. The dimension measured between the widest point on the front doors in maximum hold-open position.
- W121 VEHICLE WIDTH–REAR DOORS OPEN. The dimension measured between the widest point on the rear doors in maximum hold-open position. For vehicles with a rear door on only one side, this dimension is to the zero "Y" plane.
- W122 TUMBLE–HOME, STRAIGHT SIDE GLASS. The angle measured from a vertical to the outside surface of the front door glass at the SgRP "X" plane.
CURVED SIDE GLASS. The angle measured from a vertical to a chord extending from the upper DLO to the lower DLO at the outside surface of the front door glass at the front SgRP "X" plane.

Length Dimensions

- L101 WHEELBASE (WB). The dimension measured longitudinally between front and rear wheel centerlines. In case of dual rear axles, the dimension shall be to the midpoint of the centerlines of the rear wheels.
- L103 VEHICLE LENGTH. The maximum dimension measured longitudinally between the foremost point and the rearmost point on the vehicle, including bumper, bumper guards, tow hooks and/or rub strips, if standard equipment.
- L104 OVERHANG–FRONT. The dimension measured longitudinally from the centerline of the front wheels to the foremost point on the vehicle including bumper, bumper guards, tow hooks and/or rub strips, if standard equipment.
- L105 OVERHANG–REAR. The dimension measured longitudinally from the centerline of the rear wheels; or in the case

of dual rear axles, the dimension shall be the midpoint of the centerlines of the rear wheels, to the rearmost point on the vehicle including rear bumpers, bumper guards, tow hooks and rub strips, if standard equipment.

- L123 UPPER STRUCTURE LENGTH. The dimension measured longitudinally from the cowl point to the deck point.
- L125 COWL POINT "X" COORDINATE.
- L126 FRONT END LENGTH. The dimension measured longitudinally from the cowl point to the foremost point on the vehicle at the zero "Y" plane excluding ornamentation or bumpers. In cases where bumpers and/or grills are integrated with the profile, measurement is made at the foremost point of front end contour.
- L127 REAR WHEEL CENTERLINE "X" COORDINATE or in the case of dual rear axles, the coordinate shall be the midpoint of the distance between the rear axle centerlines.
- L129 REAR END LENGTH. The dimension measured longitudinally from the deck point to the rearmost visible point of the body sheet metal at the zero "Y" plane, excluding ornamentation or bumpers.

Height Dimensions

- H101 VEHICLE HEIGHT. The dimension measured vertically from the highest point on the vehicle body to ground.
- H111 ROCKER PANEL–REAR TO GROUND. The dimension measured vertically from the bottom of the rocker or side quarter panel at the front of the rear wheel opening, excluding flanges, to ground.
- H112 ROCKER PANEL–FRONT TO GROUND. The dimension measured vertically from the foremost point on the bottom of the rocker panels, excluding flanges, to ground.
- H114 COWL POINT TO GROUND. Measured at zero "Y" plane.
- H121 BACKLIGHT SLOPE ANGLE. The angle between the vertical reference line and the surface of backlight at vehicle zero "Y" plane. For curve backlight, the angle is to chord of backlight arc from lower DLO to upper DLO.
- H122 WINDSHIELD SLOPE ANGLE. The angle between the vertical reference line and a chord of the windshield arc running from the lower DLO to the upper DLO at the vehicle zero "Y" plane. In the case of wrap over glass, the angle to be measured will be formed by a chord 457 mm (18.0 in) long drawn from the lower DLO to the intersecting point on the windshield.
- H127 HEADLAMP TO GROUND–CURB MASS (WT.). The dimension measured vertically from the centerline of the lowest headlamp lens to ground.
- H128 TAILLAMP TO GROUND–CURB MASS (WT.). The dimension measured vertically from the centerline of the upper bulb to ground.
- H133 BOTTOM OF DOOR CLOSED–FRONT TO GROUND. The dimension measured vertically from the bottom outside corner of the door on the lock pillar side, in maximum closed position, to ground.
- H135 BOTTOM OF DOOR CLOSED–REAR TO GROUND. The dimension measured vertically from the bottom outside corner of the door on the lock pillar side, in maximum closed position, to ground.
- H138 DECK POINT TO GROUND. Measured at zero "Y" plane.
- H109 STATIC LOAD–TIRE RADIUS–REAR. Specified by the manufacturer in accordance with composite TIRE SECTION STANDARD.

Ground Clearance Dimensions

- H102 FRONT BUMPER TO GROUND. The minimum dimension measured vertically from the lowest point on the front bumper to ground, including bumper guards, if standard equipment.
- H103 FRONT BUMPER TO GROUND–CURB MASS (WT.). Measured in the same manner as H102.

MVMA Specifications Form

Passenger Car

METRIC (U.S. Customary)

Interior Car And Body Dimensions – Key Sheet

Dimensions Definitions

- H104 REAR BUMPER TO GROUND. The minimum dimension measured vertically from the lowest point on the rear bumper to ground, including bumper guards, if standard equipment.
- H105 REAR BUMPER TO GROUND – CURB MASS (WT.). Measured in the same manner as H104.
- H106 ANGLE OF APPROACH. The angle measured between a line tangent to the front tire static loaded radius arc and the initial point of structural interference forward of the front tire to ground. The limiting structural component shall be designated.
- H107 ANGLE OF DEPARTURE. The angle measured between a line tangent to the rear tire static loaded radius arc and the initial point of structural interference rearward of the rear tire to ground. The limiting component shall be designated.
- H147 RAMP BREAKOVER ANGLE. The angle measured between two lines tangent to the front and rear tire static loaded radius and intersecting at a point on the underside of the vehicle which defines the largest ramp over which the vehicle can roll.
- H153 REAR AXLE DIFFERENTIAL TO GROUND. The minimum dimension measured from the rear axle differential to ground.
- H156 MINIMUM RUNNING GROUND CLEARANCE. The minimum dimension measured from the sprung vehicle to ground. Specify location.

Glass Areas

- S1 Windshield area.
- S2 Side windows area. Includes the front door, rear door, vents, and rear quarter windows on both sides of the vehicle.
- S3 Backlight areas.
- S4 Total area. Total of all areas (S1 + S2 + S3).

Fiducial Mark Dimensions

- Fiducial Mark – Number 1**
- L54 "X" coordinate.
- W21 "Y" coordinate.
- H81 "Z" coordinate.
- H161 Height "Z" coordinate to ground at curb weight.
- H163 Height "Z" coordinate to ground.
- Fiducial Mark – Number 2**
- L55 "X" coordinate.
- W22 "Y" coordinate.
- W82 "Z" coordinate.
- H162 Height "Z" coordinate to ground at curb weight.
- H164 Height "Z" coordinate to ground.

Front Compartment Dimensions

- L7 STEERING WHEEL TORSO CLEARANCE. The minimum dimension measured in the side view from the rearmost edge of the steering wheel, with front wheels in the straight ahead position, to the torso line.
- L11 ACCELERATOR HEEL POINT TO STEERING WHEEL CENTER. The dimension measured horizontally from the AHP to the intersection of the steering column centerline and a plane tangent to the upper surface of the steering wheel rim.
- L17 DESIGN H-POINT–FRONT TRAVEL. The dimension measured horizontally between the design H-point–front in the foremost and rearmost seat track positions. (See SAE J1100)
- L23 NORMAL DRIVING AND RIDING SEAT TRACK LEVEL. The dimension measured horizontally between a point on the design H-point travel line from the SgRP to the displaced point on the design H-point travel line with the seat moved to the foremost seat position, but not to include seat track travel used for purposes other than normal driving and riding positions. (See SAE J1100)
- L31 SgRP–FRONT. "X" COORDINATED.

- L34 MAXIMUM EFFECTIVE LEG ROOM–ACCELERATOR. The dimension measured along a line from the ankle pivot center to the SgRP–front plus 254 mm (10.0 in.) measured with right foot on the undepressed accelerator pedal. For vehicles with SgRP to heel (H30) greater than 18 in., the accelerator pedal may be depressed as specified by the manufacturer. If the accelerator is depressed, the manufacturer shall place foot flat on pedal and note the depression of the pedal.
- L40 BACK ANGLE–FRONT. The angle measured between a vertical line through the SgRP–front and the torso line. If the seatback is adjustable, use the normal driving and riding position specified by the manufacturer.
- L42 HIP ANGLE–FRONT. The angle measured between torso line and thigh centerline.
- L44 KNEE ANGLE–FRONT. The angle measured between thigh centerline and lower leg centerline measured on the right leg.
- L46 FOOT ANGLE–FRONT. The angle measured between the lower leg centerline and a line tangent to the ball and heel of the bare foot flesh line measured on the right leg. Ref SAE J826.
- L53 SgRP–FRONT TO HEEL. The dimension measured horizontally from the SgRP–front to the accelerator heel point.
- W3 SHOULDER ROOM–FRONT. The minimum dimension measured laterally between the trimmed surfaces on the "X" plane through the SgRP–front at height between the belt line and 254 mm (10.0 in.) above the SgRP–front, excluding the door assist strap and attaching parts.
- W5 HIP ROOM–FRONT. The minimum dimension measured laterally between the trimmed surfaces on the "X" plane through the SgRP–front within 25 mm (1.0 in.) below and 76 mm (3.0 in.) above the SgRP–front and 76 mm (3.0 in.) fore and aft of the SgRP–front.
- W9 STEERING WHEEL MAXIMUM OUTSIDE DIAMETER. Define if other than round.
- H13 STEERING WHEEL TO CENTERLINE OF THIGH. The minimum dimension measured from the bottom of steering wheel, with front wheels in the straight position, to the thigh centerline.
- H17 ACCELERATOR HEEL POINT TO THE STEERING WHEEL CENTER. The dimension measured vertically from the AHP–front to the intersection of the steering column centerline to a plane tangent to the upper surface of the steering wheel rim.
- H18 STEERING WHEEL ANGLE. The angle measured from a vertical to the surface plane of the steering wheel.
- H30 SgRP–FRONT TO HEEL. The dimension measured vertically from the SgRP–front to the accelerator heel point.
- H37 HEADLINING TO ROOF PANEL–FRONT. The dimension measured from the intersection of the headlining and the extended effective head room line normal to the sheet metal.
- H50 UPPER BODY OPENING TO GROUND–FRONT. The dimension measured vertically from the trimmed body opening to the ground on the SgRP–front "X" plane.
- H61 EFFECTIVE HEAD ROOM–FRONT. The dimension measured along a line 8 deg. rear of vertical from the SgRP–front to the headlining plus 102 mm (4.0 in.).
- H67 FLOOR COVERING THICKNESS–UNDEPRESSED–FRONT. The dimension measured vertically from the surface of the undepressed floor covering to the underbody sheet metal at the accelerator heel point.
- PD1 PASSENGER DISTRIBUTION–FRONT.

Rear Compartment Dimensions

- L3 COMPARTMENT ROOM–SECOND. The dimension measured horizontally from the back of front seat to the front of the second seatback at a height tangent to the top of the second seat cushion.

MVMA Specifications Form

Passenger Car

METRIC (U.S. Customary)

Interior Car And Body Dimensions - Key Sheet

Dimensions Definitions

- L-41 BACK ANGLE-SECOND. The angle measured between a vertical line through the SgRP-second and the torso line.
- L43 HIP ANGLE-SECOND. The angle measured between torso line and thigh centerline.
- L45 KNEE ANGLE-SECOND. The angle measured between thigh centerline and lower leg centerline.
- L47 FOOT ANGLE-SECOND. The angle measured between the lower leg centerline and a line tangent to the ball and heel of the three-dimensional devices bare foot flesh line (Reference J826).
- L48 KNEE CLEARANCE-SECOND. The minimum dimension measured from the knee pivot center to the back of the front seatback minus 51 mm (2.0 in.).
- L50 SgRP COUPLE DISTANCE-SECOND. The dimension measured horizontally from the driver SgRP-front to the SgRP-second.
- L51 MINIMUM EFFECTIVE LEG ROOM-SECOND. The dimension measured along a line from the ankle pivot center to the SgRP-second plus 254mm (10.0 in.)
- W4 SHOULDER ROOM-SECOND. The minimum dimension measured laterally between door or quarter trimmed surfaces on the "X" plane through the SgRP-second at height between 254-406 mm (10.0-16.0 in.) above the SgRP-second, excluding the door assist straps and attaching parts.
- W6 HIP ROOM-SECOND. Measured in the same manner as W5.
- H31 SgRP-SECOND TO HEEL. The dimension measured vertically from the SgRP-second to the two dimensional device heel point on the depressed floor covering.
- H38 HEADLINING TO ROOF PANEL-SECOND. The dimension measured from the intersection of the headlining and the extended effective head room line normally to the roof sheet metal.
- H51 UPPER BODY OPENING TO GROUND-SECOND. The dimension measured vertically from the trimmed body opening to the ground on the "X" plane 330 mm (13.0 in.) forward of the SgRP-second.
- H63 EFFECTIVE HEAD ROOM-SECOND. The dimension measured along a line 8 deg. rear of vertical from the SgRP to the headlining, plus 102 mm (4.0 in.)
- H73 FLOOR COVERING-DEPRESSED-SECOND. The dimension measured vertically from the heel point to the underbody sheet metal.
- PD2 PASSENGER DISTRIBUTION-SECOND.

Luggage Compartment Dimensions

- V1 USABLE LUGGAGE CAPACITY-Total of volumes of individual pieces of standard luggage set plus H-boxes stowed in the luggage compartment in accordance with the procedure described in paragraph 8.2 of SAE-J1100a.
- H195 LIFTOVER HEIGHT. The dimension measured vertically from the luggage compartment lower opening at the zero "Y" plane to ground.

Interior Volumes (EPA Classification)

The Interior Volume Index is listed for each body style except two seaters. The interior volume index estimates the space in a car. It is based on four measurements - head room, shoulder room, hip room, and leg room - for the front and rear seats, plus trunk capacity. The interior volume index is an estimate of the size of the passenger compartment.

The Trunk Cargo Index is an estimate of the size of the trunk/cargo space in station wagons and hatchbacks it is an estimate of the space behind the second seat.

Station Wagon - Third Seat Dimensions

- L85 SgRP COUPLE DISTANCE-THIRD. The dimension measured horizontally from the SgRP-second to the SgRP-third.
- L86 EFFECTIVE LEG ROOM-THIRD. The dimension measured along a line from the ankle pivot center to the SgRP-third plus 254 mm (10.0 in.).
- L87 KNEE CLEARANCE-THIRD. The minimum dimension from the knee pivot center to the back of second seatback minus a constant of 51mm (2.0 in.). With rear-facing third seat, dimension is measured to closure.
- L88 BACK ANGLE-THIRD. Measured in the same manner as L41.
- L89 HIP ANGLE-THIRD. Measured in the same manner as L43.
- L90 KNEE ANGLE-THIRD. Measured in the same manner as L45.
- L91 FOOT ANGLE-THIRD. Measured in the same manner as L47.
- W85 SHOULDER ROOM-THIRD. Measured in the same manner as W4.
- W86 HIP ROOM-THIRD. Measured in the same manner as W5.
- H86 EFFECTIVE HEAD ROOM-THIRD. The dimension, measured along a line 8 deg. from the SgRP-third to the headlining rear of vertical plus a constant of 102 mm (4.0 in.).
- H87 SgRP-THIRD TO HEEL POINT.
- PD3 PASSENGER DIRECTION-THIRD.
- SD1 SEAT FACING DIRECTION-THIRD.

Station Wagon - Cargo Space Dimensions

- L200 CARGO LENGTH-OPEN-FRONT. The minimum dimension measured longitudinally from the back of the front seatback at the height of the undepressed floor covering to the rearmost point on the undepressed floor covering on the open tailgate or cargo surface if the rear closure is a conventional door type tailgate at the zero "Y" plane.
- L201 CARGO LENGTH-OPEN-SECOND. The dimension measured longitudinally from the back of the second seatback at the height of the undepressed floor covering to the rearmost point on the undepressed floor covering on the open tailgate or cargo floor surface if the rear closure is a conventional door type tailgate, at the zero "Y" plane.
- L202 CARGO LENGTH-CLOSED-FRONT. The minimum dimension measured horizontally from the back of the front seat at the height of the undepressed floor covering to the rearmost point on the undepressed floor covering on the closed tailgate or taildoor for station wagons, trucks and mpv's at the zero "Y" plane.
- L203 CARGO LENGTH-CLOSED-SECOND. The dimension measured horizontally from the back of the second seat at the height of the undepressed floor covering to the rearmost point on the undepressed floor covering on the closed tailgate or taildoor for station wagons, trucks and mpv's at the zero "Y" plane.
- L204 CARGO LENGTH AT BELT-FRONT. The minimum dimension measured horizontally from the back of the front seatback at the seatback top to the foremost normal surface of the closed tailgate or inside surface of the cab backpanel at the height of the belt, on the zero "Y" plane.
- L205 CARGO LENGTH AT BELT-SECOND. The minimum dimension measured horizontally from the back of the second seatback at the seatback top to the foremost normal surface of the closed tailgate at the height of the belt, on the zero "Y" plane.
- W201 CARGO WIDTH-WHEELHOUSE. The minimum dimension measured laterally between the trimmed wheelhouseings at floor level. For any vehicle not trimmed, measure to the sheet metal.

MVMA Specifications Form Passenger Car

METRIC (U.S. Customary)

Interior Car And Body Dimensions – Key Sheet Dimensions Definitions

- W203 REAR OPENING WIDTH AT FLOOR. The minimum dimension measured laterally between the limiting interferences of the rear opening at floor level.
- W204 REAR OPENING WIDTH AT BELT. The minimum dimension measured laterally between the limiting interferences of the rear opening at belt height or top of pick up box.
- W205 REAR OPENING WIDTH ABOVE BELT. The minimum dimension measured laterally between the limiting interferences of the rear opening above the belt height.
- H197 FRONT SEATBACK TO LOAD FLOOR HEIGHT. The dimension measured vertically from the horizontal tangent to the top of the seatback to the undepressed floor covering.
- H201 CARGO HEIGHT. The dimension measured vertically from the top of the undepressed floor covering to the headlining at the rear wheel "X" coordinate on the zero "Y" plane.
- H202 REAR OPENING HEIGHT. The dimension measured vertically from the top of the undepressed floor covering to the upper trimmed opening on the zero "Y" plane with rear door fully open.
- H250 TAILGATE TO GROUND CURB MASS (WT.). The dimension measured vertically from the top of the undepressed floor covering on the lowered tailgate to ground on the zero "Y" plane.
- V2 STATION WAGON
Measured in inches:

$$\frac{W4 \times H201 \times L204}{1728} = \text{ft}^3$$
 Measured in mm:

$$\frac{W4 \times H201 \times L204}{10^9} = \text{m}^3 \text{ (cubic meter)}$$
- V4 HIDDEN LUGGAGE CAPACITY-REAR OF FRONT SEAT. The total volumes of individual pieces of one set of standard luggage stowed in any hidden cargo area below the load floor rear of the front seat.
- V5 TRUCKS AND MPV'S WITH OPEN AREA.
Measured in inches:

$$\frac{L506 \times W500 \times H503}{1728} = \text{ft}^3$$
 Measured in mm:

$$\frac{L506 \times W500 \times H503}{10^9} = \text{m}^3 \text{ (cubic meter)}$$
- V6 TRUCKS AND MPV'S WITH CLOSED AREA.
Measured in inches:

$$\frac{L204 \times W500 \times H505}{1728} = \text{ft}^3$$
 Measured in mm:

$$\frac{L204 \times W500 \times H505}{10^9} = \text{m}^3 \text{ (cubic meter)}$$
- V8 HIDDEN LUGGAGE CAPACITY-REAR OF SECOND SEAT. The total volume of individual pieces of one set of standard luggage stowed in any hidden cargo area below the load floor rear of the second seat.
- V10 STATION WAGON CARGO VOLUME INDEX.
Measured in inches:

$$\frac{H201 \times L205 \times \frac{W4 + W201}{2}}{1728} = \text{ft}^3$$
 Measured in mm:

$$\frac{H201 \times L205 \times \frac{W4 + W201}{2}}{10^9} = \text{m}^3 \text{ (cubic meter)}$$

Hatchback – Cargo Space Dimensions

All hatchback cargo dimensions are to be taken with the front seat in full down and rear position, and the rear seat folded down. The hatchback door is in the closed position. (For electrically adjusted seats, see the manufacturer's specifications for Design "H" Point).

- L208 CARGO LENGTH AT FRONT SEATBACK HEIGHT. The minimum horizontal dimension from the "X" plane tangent to the rearmost surface of the driver's seatback to the inside limiting interference of the hatchback door on the vehicle zero "Y" plane.
- L209 CARGO LENGTH AT FLOOR-FRONT-HATCHBACK. The minimum horizontal dimension measured at floor level from the rear of the front seatback to the normal limiting interference of the hatchback door on the vehicle zero "Y" plane.
- L210 CARGO LENGTH AT SECOND SEATBACK HEIGHT-HATCHBACK. The minimum dimension measured from the "X" plane tangent to the rearmost surface of second seatback or the load floor which is stowed at least one half of the H198 dimension height above the rear load floor, to the rearmost inside limiting interference on the zero "Y" plane.
- L211 CARGO LENGTH AT FLOOR-SECOND HATCHBACK. The minimum horizontal dimension measured at floor level from the rear of the second seatback or load floor panel to the normal limiting interference of the hatchback door on the vehicle zero "Y" plane.
- H197 FRONT SEATBACK TO LOAD HEIGHT. The dimension measured vertically from the horizontal tangent to the top of the seatback to the undepressed floor covering.
- H198 SECOND SEATBACK TO LOAD FLOOR HEIGHT: The dimension measured vertically from the second seat back to the undepressed floor covering.
- V3 HATCHBACK.
Measured in inches:

$$\frac{L208 + L209}{2} \times W4 \times H197 = \text{ft}^3$$
 Measured in mm:

$$\frac{L208 + L209}{2} \times W4 \times H197 = \text{m}^3 \text{ (cubic meter)}$$
- V4 HIDDEN LUGGAGE CAPACITY-REAR OF FRONT SEAT. The total volumes of individual pieces of one set of standard luggage stowed in any hidden cargo area below the load floor rear of the front seat.
- V11 HATCHBACK CARGO VOLUME INDEX. Usable luggage (one (1) stand and luggage set) below floor:
Measured in inches:

$$\frac{L210 + L211}{2} \times W4 \times H198 = \text{ft}^3$$
 Measured in mm:

$$\frac{L210 + L211}{2} \times W4 \times H198 = \text{m}^3 \text{ (cubic meter)}$$

MVMA Specifications Form

Passenger Car

METRIC (U.S. Customary)

Index

Subject	Page No.	Subject	Page No.
Aerodynamics	22	Lamps and Headlamp Shape	24
Alternator	16	Legroom	21, 22
Automatic Transmission/Transaxle	8, 9	Lengths - Car and Body	20
Axis, Steering	14	Leveling, Suspension	11
Axle, Drive, Front, Rear	2, 9, 10	Lifters, Valve	4
Axle Shafts	10	Linings - Clutch, Brake	8, 12
Battery	16	Lubrication - Engine Transmission/Transaxle	4, 8, 9
Body and Miscellaneous Information	17	Luggage Compartment	21
Brakes-Parking, Service	12, 13	Mass	25, 26
Camber	15	Models	1
Camshaft	3	Motor Starting	16
Capacities		Muffler	7
Cooling System	5	Passenger Capacity	1
Fuel Tank	6	Passenger Mass Distribution	25
Lubricants		Pistons	3
Engine Crankcase	4	Power Brakes	12
Transmission/Transaxle	8, 9	Power, Engine	2
Rear Axle	10	Power Steering	14
Car Models	1	Power Teams	2
Car and Body Dimensions		Propeller Shaft, Universal Joints	10
Width	20	Pumps - Fuel	6
Length	20	Water	5
Height	20	Radiator - Cap, Hoses, Core	5
Ground Clearance	20	Ratios - Axle, Transaxle	2, 9
Front Compartment	21	Compression	2
Rear Compartment	21	Steering	14
Luggage Compartment	21	Transmission/Transaxle	2, 8, 9
Station Wagon - Third Seat	22	Rear Axle	2, 9, 10
Station Wagon - Cargo Space	22	Regulator - Alternator	16
Hatchback - Cargo Space	22	Restraint System	18
Carburetor	2, 6	Rims	13
Caster	15	Rods - Connecting	4
Choke, Automatic	6	Scrub Radius	14
Clutch - Pedal Operated	8	Seats	17
Coil, Ignition	16	Shock Absorbers, Front & Rear	11
Connecting Rods	4	Spark Plugs	16
Convenience Equipment	19	Speedometer	15
Cooling System	5	Springs - Front & Rear Suspension	11
Crankshaft	4	Stabilizer (Sway Bar) - Front & Rear	11
Cylinders and Cylinder Head	3	Starting System	16
Diesel Information	4	Steering	14
Dimension Definitions		Suppression - Ignition, Radio	16
Key Sheet - Exterior	27, 30, 31	Suspension - Front & Rear	11
Key Sheet - Interior	28, 29, 31, 32, 33	Tail Pipe	7
Electrical System	15, 16	Theft Protection	19
Emission Controls	7	Thermostat, Cooling	5
Engine - General		Tires	13
Bore, Stroke, Type	3	Toe-In	15
Compression Ratio	2	Torque Converter	9
Displacement	2, 3	Torque - Engine	2, 8, 9
Firing Order, Cylinder Numbering	3	Transaxle	9
General Information, Power & Torque	2	Transmission - Types	2, 8, 9
Intake System	4	Transmission - Automatic	2, 8, 9
Power Teams	2	Transmission - Manual	2, 8, 9
Exhaust System	7	Transmission - Ratios	2, 9
Equipment Availability, Convenience	19	Tread	20
Fan, Cooling	5	Trunk Cargo Load	1
Fiducial Marks	23	Trunk Luggage Capacity	21
Filters - Engine Oil, Fuel System	4	Turning Diameter	14
Frame	17	Utilized Construction	17
Front Suspension	11	Universal Joints, Propeller Shaft	10
Front Wheel Drive Unit	10	Valve System	4
Fuel System	6	Voltage Regulator	16
Fuel Injection	6	Water Pump	5
Fuel Tank	6	Weights	25, 26
Glass	18	Wheel Alignment	15
Headroom - Body	21, 22	Wheelbase	20
Heights - Car and Body	20	Wheels & Tires	13
Horns	15	Wheel Spindle	14
Horsepower - Brake	2	Widths - Car and Body	20
Ignition System	16	Windshield	18
Inflation - Tires	13	Windshield Wiper and Washer	15
Interior Volumes	21		
Instruments	15		

**MVMA Specifications Form
Passenger Car**

**METRIC (U.S. Customary)
SUPPLEMENTAL PAGE**

Car Line _____
Model Year _____ Issued _____ Revised (●) _____
