

S-10 BLAZER

1987



S-10 BLAZER

EXTERIOR

- One new color is available, Emerald Metallic (code 44).
- Sunshine Striping decal package, RPO D90, is now available on Blazer models with both solid paint and Custom Two-Tone paint, RPO ZY6.

INTERIOR

- New leather and suede trimmed bucket seats with a "Trail Blazer" label affixed to the headrest are now available on up-trim levels YC2 and YC3. These seats are available in Saddle Tan or Charcoal. The optional rear seat, RPO AM7, is also available with this new leather and suede trim.
- High Country Sheepskin bucket seats have been discontinued.
- A new High Country package, RPO YH9, will be introduced interim 1987. It will feature a black and gold color scheme with gold lower paint color and the use of a decal gradually blending into the black upper body color. Included are special gold painted aluminum wheels, gold color-keyed bumpers with rub strips and gold fender nameplates. The package also contains black chrome grille, black exterior mirrors, black body side moldings, and black plastic wheel-opening moldings. On the inside, Special Custom Cloth seats are included. The optional



leather and suede seat trim, when ordered, adds to the sporty appearance of this exciting new High Country package.

BODY

- Color-keyed vinyl floor mats, RPO BG9, currently included in the YC1 trim level, are now available, when uplevel trim levels YC2 or YC3 are ordered.

CHASSIS AND POWERTRAIN

- The standard 2.5 Liter EFI gas engine incorporates further improvements which include high-flow ports in the cylinder head and a redesigned intake manifold.
- A single belt accessory belt drive, also called serpentine

drive, replaces the conventional multiple V-belts. Benefits are:

- Automatic belt tensioning
- Spring-loaded tensioner
- Less complex system
- 100,000-mile life expectancy

- A three-speed automatic transmission, RPO MX1, is available with the 2.8 Liter V6 and as an interim release with the 2.5 Liter engine.

- A new 85-amp DelcoTron generator replaces the 78-amp unit as standard equipment.

The new unit is lighter and benefits include improved performance, added durability and improved serviceability.

- New Delco Freedom batteries feature a "flat top" case. This new battery provides an increase in cold cranking amps from 405 to 525 and the optional heavy-duty battery, RPO UAI, increases from 540 to 630 cold cranking amps.

S-10 BLAZER

OPTIONS

- New High Country package (interim 1987).
- Custom Two-Tone paint. Provides secondary paint placement from the upper body belt styling line to the bottom of the truck, including the hood and tailgate.
- Sunshine Striping Decal Package (side of vehicle and across rear end gate). Available with solid paint ZY1 or custom Two-Tone ZY6.
- Factory-installed rear-mounted spare tire carrier, RPO P16, is now available.
- Styled wheels for 2WD Blazer feature an attractive paint scheme.
- The Sport trim features black chrome finish on grille and headlamp bezels, black-finish tail lamp bezels, black key cylinder locks and door handles.
- Custom Vinyl and Custom Cloth seat trim fabrics.
- Scots tweed cloth of felt and corduroy.
- The intermittent windshield wiper system control is included in Smart Switch on the steering column.

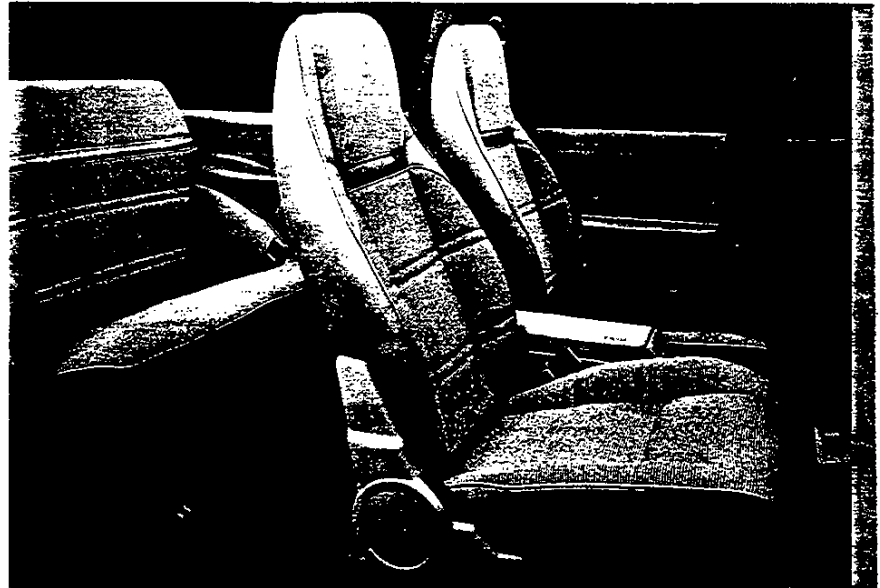

- Usage of all-season tread design includes many optional tires on 4x4 models.
- Cast aluminum spare wheel is available for use with cast aluminum wheels.
- Precleaner air cleaner is available for use with the 2.8 Liter V6 engine only.
- Four-speed automatic transmission with overdrive is available with the 2.5 Liter L4 gas engine on all Blazer models.

STANDARD VALUE FEATURES

ALL THIS AT NO EXTRA COST:

- 2.5 Liter and optional 2.8L V6 Electronic Fuel Injection (EFI) engines for impressive performance.
- Upshift light on instrument panel to indicate best time to shift the manual transmission for best fuel economy.
- Available in 2WD/4WD models.
- Low-pressure gas shock absorbers for impressive ride.
- Double-wall construction has both an inner and outer wall in the hood, doors, front fenders, quarter panels and endgate for added body strength.
- Door hinges welded to door frames in a master control fixture for precision control of gap tolerances.
- Standard 13.2-gallon fuel tank. Optional 20-gallon tank available.
- 15-inch tires and wheels.
- Steel-belted all-season radial ply tires for good traction and tread life.
- RH and LH mirrors with low-gloss black finish.
- Full-length steel, non-removable roof.
- Fold-down endgate and lift-glass window. Center key lock releases endgate and gas-operated lift-glass.
- Tinted glass standard, all windows. Deep tint available.
- Molded plastic grille, chrome and black integral Chevrolet emblem in center of grille.



- Endgate lettering, black or silver decal on embossed Chevrolet letters, depending on exterior color.
- Fluidic windshield washer provides good spray pattern for cleaning.
- Self-adjusting front disc brakes have audible wear sensors as an early warning of front brake wear.
- Rear brake adjusters to eliminate periodic brake adjustments.
- Folding, high-back bucket seats (shown above) with easy-entry feature on RH seat.
- Full interior trim, including rear.
- Single-tone interior color scheme in four colors.
- Seat belts with outboard retractors in front.
- Full door trim panels with armrests and headliner for good appearance and acoustics.
- Sunshades (2), ashtray, inside mirror and coat hooks (2) for convenience.
- Plastic scuff plate at endgate and front door-sill plates.
- Floor mat with bonded insulation for front and rear compartments.
- Rear quarter trim panels cover exposed sheet metal from front door to endgate.
- Column-mounted Smart Switch controls turn signals, headlight beam mode and wiper/washer for driver's convenience.
- Seat adjuster on driver's and passenger's seats.
- Inside hood release provides increased theft protection for engine compartment.
- Sliding door lock levers help deter theft.
- Grab handles on 4x4 Blazers for all passenger seating positions.
- Fuse block for easy serviceability.

ENGINE VALUE FEATURES

The 2.5 Liter L4 gas engine incorporates the latest in high technology and features a computer-controlled Electronic Fuel Injection (EFI) system:

- It's simpler. It takes the complexity out of the engine compartment and places it in the Electronic Control Module (ECM).
- It's more responsive, especially during cold starts and warm-ups.
- It offers outstanding fuel economy.
- It is far less sensitive to the extremes of operating conditions and it is altitude compensated.
- The simpler EFI system has proved to be easier to service. It eliminates the carburetor, choke, needle valve and float.

Other high-technology features include:

- Lightweight castings: head, block and crankshaft.
- Hi-Flow aluminum intake manifold reduces weight.
- Fabricated stainless steel exhaust manifold.
- Roller hydraulic valve lifters reduce friction.
- Low-tension oil rings reduce friction.

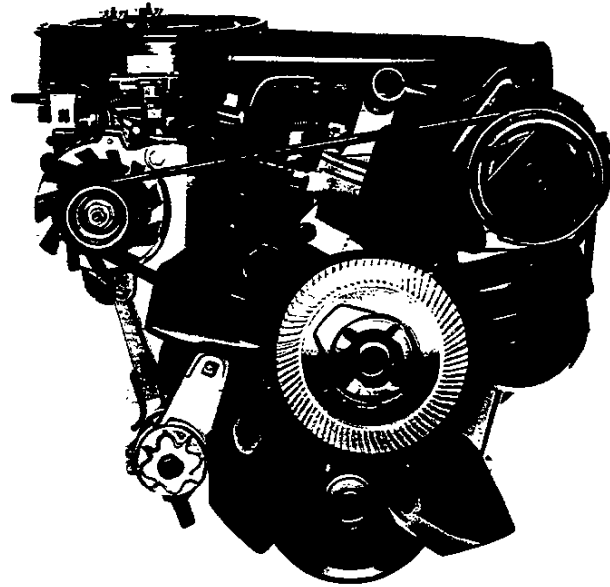

- High torque improves low engine speed operation.
- Centralized, compound angle spark plug.
- Special pistons for truck use.
- 8.9 to 1 compression ratio.
- Serpentine accessory belt drive for 100,000-mile life expectancy.
- 2.8 Liter V6 engine with Electronic Fuel Injection available on all Blazers for improved driveability; net horsepower is 125 @ 4,800 RPM, net torque is 150 @ 2,400 RPM.

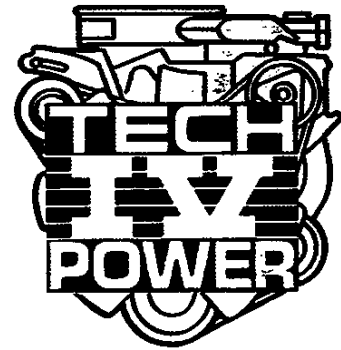

CHASSIS VALUE FEATURES

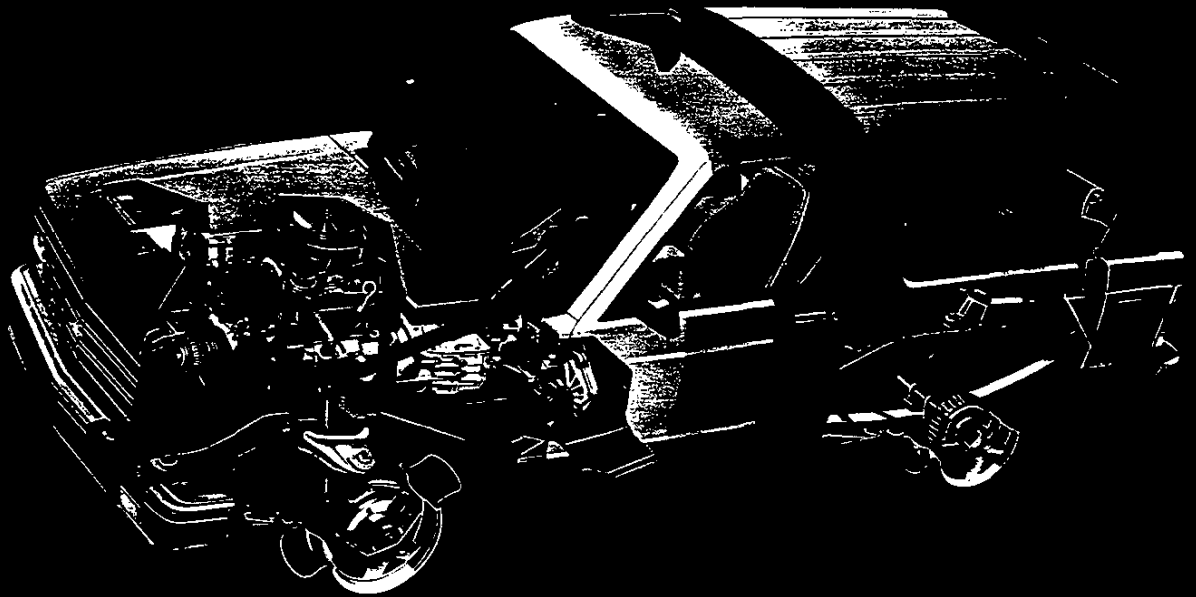

FRAME ASSEMBLIES (2WD AND 4WD)

- Full-frame construction.
- All S-10 frames are hot-wax-coated for corrosion protection.
- Box-section front frame with channel-type rear side rails.
- All welded, except for riveted rear cross members for strength.
- Five cross members for 2WD frames. Six cross members for 4WD frames.

FRONT SUSPENSION (2WD)

- Independent front suspension with coil springs provides an impressive, smooth ride.
- Computer-selected front springs matched to vehicle weight.
- Control arms are rubber bushed for noise and shock damping.

- 1" diameter solid bar front stabilizer standard.
- Ball joints equipped with visible wear indicators.
- 25mm low-pressure gas-filled shock absorbers standard.

FRONT SUSPENSION AND CHASSIS (4WD)

- Rubber-bushed upper and lower control arms with torsion bar springs.
- Insta-Trac 4-wheel-drive system features vacuum-activated center lock feature for free-wheeling in 2WD and easy shift to 4WD Hi while moving at any speed.
- Two-speed transfer case with single shift lever and illuminated shift panel.
- Four universal joints provide independent articulation.
- Torsion bar front springs, computer selected and adjusted for trim at factory.

- 1" diameter front stabilizer bar standard.
- 25mm low-pressure gas-filled shock absorbers standard.

REAR SUSPENSION

- Recambered rear springs for revised trim height.
- Two-state, multileaf springs adjust to the load to provide smooth ride.
- Ionoclad anti-corrosion paint used on rear springs.

TRAILERING

With the available V6 engine and Heavy-Duty Trailering Package, a 2WD S-10 tows up to 5,000 lbs. (4,000 lbs. for 4WD), including trailer and cargo.

S-10 BLAZER 2- & 4-WHEEL DRIVE Paint Applications

SOLID PAINT—ZY1
(w/o Optional Striping)

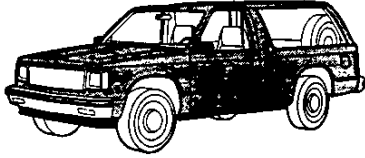

SOLID PAINT—ZY1
(with D85 Body Striping)

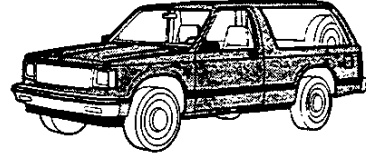

SOLID PAINT—ZY1
(with D90 Sunshine striping)
(Includes body side and end gate striping)

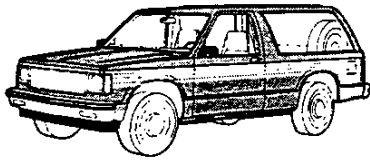

SOLID PAINT—ZY1
(with D98 Rally Striping)

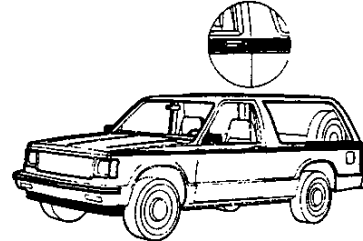

SPORT TWO-TONE PAINT—ZY7
(Includes body side stripe that matches
color code 2 w/o YC3 or YC2)

Color Code 1

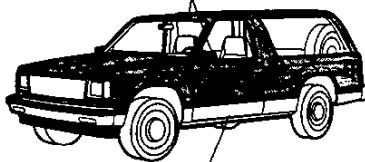

Color Code 2

SPECIAL TWO-TONE PAINT—ZY8
(Includes B84 Body Side and Bright Wheel Opening Moldings)

Color Code 1



Color Code 2

CUSTOM TWO-TONE PAINT—ZY6
(w/o D90 Sunshine Striping)

Color Code 1

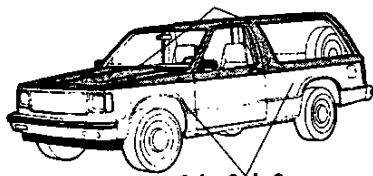

Color Code 2

CUSTOM TWO-TONE PAINT—ZY6
(with D90 Sunshine Striping)
(Includes body side and end gate striping)

Color Code 1

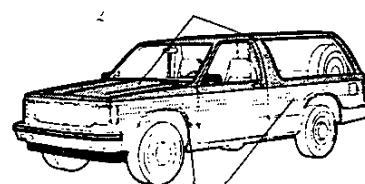

Color Code 2

CUSTOM TWO-TONE PAINT—ZY6
(with YH9 High Country Package)
(Requires YC2/YC3 Package—Includes Decal Striping)

Color Code 1

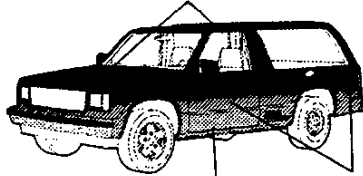

Color Code 2

Decal Striping

S-10 BLAZER 2- & 4-WHEEL DRIVE

INTERIOR AND EXTERIOR COLOR AVAILABILITY CHART

Please Note: Below are the interior trim color and exterior paint combinations recommended by Chevrolet. The only available color code 1/color code 2 exterior color combinations are those shown in the chart below; however, any available interior trim color may be ordered with one of these exterior color combinations if that particular combination is desired by the customer.

WITH ZY1 PAINT—WITHOUT STRIPING

TRIM LEVEL Seat Type	Decor	INTERIOR COLORS			
		Blue	Carmine	Charcoal	Saddle Tan
STANDARD INTERIOR Custom Vinyl High Back Bucket Seats	Std	XDD4	XRR4	XJJ4	XSS4
TAHOE Custom Vinyl High Back Bucket Seats	YC2	XDD4	XRR4	XJJ4	XSS4
Special Custom Cloth High Back Bucket Seats		HDD4	HRR4	HJJ4	HSS4
High Country Sheepskin High Back Bucket Seats					*BSS4
Leather High Back Reclining Bucket Seats				AJJ6	ASS6
EXTERIOR COLORS w/ZY1 PAINT	Color Code 1	Color Code 2	RECOMMENDED INTERIOR TRIM COLORS		
BLACK, MIDNIGHT	19	19		X	
BLACK, MIDNIGHT	19	19			X
BLACK, MIDNIGHT	19	19			X
BLUE, GALAXY (Metallic)	28	28	X		X
BLUE, GALAXY (Metallic)	28	28		X	X
BLUE, LIGHT (Metallic)	21	21	X		X
BRONZE, INDIAN (Metallic)	66	66		X	
BRONZE, INDIAN (Metallic)	66	66			X
EMERALD (Metallic)	44	44		X	
EMERALD (Metallic)	44	44			X
GOLD, NEVADA (Metallic)	67	67		X	X
GRAY, STEEL (Metallic)	90	90	X		
GRAY, STEEL (Metallic)	90	90		X	
GRAY, STEEL (Metallic)	90	90		X	
RED, APPLE	72	72		X	
RED, APPLE	72	72		X	
TAN, DOESKIN	61	61		X	
TAN, DOESKIN	61	61			X
WHITE, FROST	12	12	X		
WHITE, FROST	12	12		X	
WHITE, FROST	12	12		X	
WHITE, FROST	12	12			X

N/A-Not Available

*With YC2 Tahoe, rear seat trim is Special Custom Cloth.

WITH D85 BODY STRIPING AND ZY1 PAINT

TRIM LEVEL Seat Type	Decor	INTERIOR COLORS				D85 STRIPING CHART RECOMMENDED COMBINATIONS							
		Blue	Carmine	Charcoal	Saddle Tan	Additional stripe combinations are available except where N/A is shown, provided the dealer orders (D60) as verification (N/A B84)							
STANDARD INTERIOR Custom Vinyl High Back Bucket Seats	Std	XDD4	XRR4	XJJ4	XSS4								
EXTERIOR COLORS w/ZY1 PAINT	Color Code 1	Color Code 2	RECOMMENDED INTERIOR TRIM COLORS			STRIPE COLORS							
						Black 19A	Blue, Dark 28A	Gold 67A	Gray 90A	Red 72A	Silver 17A	White 12A	
BLACK, MIDNIGHT	19	19		X		N/A	N/A			X			
BLACK, MIDNIGHT	19	19			X	N/A	N/A				X		
BLACK, MIDNIGHT	19	19			X	N/A	N/A	X					
BLUE, GALAXY (Metallic)	28	28	X		X	N/A	N/A		N/A		X		
BLUE, GALAXY (Metallic)	28	28			X	N/A	N/A	X	N/A				
BLUE, LIGHT (Metallic)	21	21	X		X		X	N/A	N/A	N/A			
BRONZE, INDIAN (Metallic)	66	66			X	N/A	N/A		N/A	N/A	X		
BRONZE, INDIAN (Metallic)	66	66			X	N/A	N/A	X	N/A	N/A	N/A		
EMERALD (Metallic)	44	44			X	N/A	N/A		N/A	N/A	N/A	X	
EMERALD (Metallic)	44	44			X	N/A	N/A	X	N/A	N/A	N/A		
GOLD, NEVADA (Metallic)	67	67			X	X	N/A	N/A	N/A	N/A	N/A		
GRAY, STEEL (Metallic)	90	90	X				X	N/A	N/A		N/A		
GRAY, STEEL (Metallic)	90	90		X				N/A	N/A	X	N/A		
GRAY, STEEL (Metallic)	90	90			X	X		N/A	N/A		N/A		
RED, APPLE	72	72		X			N/A			N/A	X		
RED, APPLE	72	72			X	X	N/A			N/A			
TAN, DOESKIN	61	61			X	X		N/A			N/A		
TAN, DOESKIN	61	61			X	X		N/A			N/A		
WHITE, FROST	12	12	X				X					N/A	
WHITE, FROST	12	12		X						X		N/A	
WHITE, FROST	12	12			X				X			N/A	
WHITE, FROST	12	12			X			X				N/A	

N/A-Not Available

S-10 BLAZER 2- & 4-WHEEL DRIVE INTERIOR AND EXTERIOR COLOR AVAILABILITY CHART WITH BODY STRIPING AND ZY6, ZY7 or ZY8 PAINT

Please Note: Below are the interior trim color and exterior paint combinations recommended by Chevrolet. The only available color code 1/color code 2 exterior color combinations are those shown in the chart below, however, any available interior trim color may be ordered with one of these exterior color combinations if that particular combination is desired by the customer.

TRIM LEVEL Seat Type	INTERIOR COLORS				
	Decor	Blue	Carmine	Charcoal	Saddle Tan
STANDARD INTERIOR Custom Vinyl High Back Bucket Seats	Std.	XDD4	XRR4	XJJ4	XSS4
TAHOE Custom Vinyl High Back Bucket Seats	YC2	XDD4	XRR4	XJJ4	XSS4
Special Custom Cloth High Back Bucket Seats		HDD4	HRR4	HJJ4	HSS4
High Country Sheepskin High Back Bucket Seats					*BSS4
Leather High Back Reclining Bucket Seats				AJJ6	ASS6
SPORT (Reqs. ZY6 or ZY7 Paint) Deluxe Cloth High Back Bucket Seats	YC3			DJJ4	DSS4
High Country Sheepskin High Back Bucket Seats					*BSS4
Leather High Back Reclining Bucket Seats				AJJ6	ASS6

EXTERIOR COLORS w/ZY6, ZY7 or ZY8 PAINT	Color Code 1	Color Code 2	RECOMMENDED INTERIOR TRIM COLORS						STRIPE COLORS - ZY7 ONLY (Stripe Colors Cannot be Changed) (N/A ZY8) (With ZY6 Paint Refer to Page 6 for Striping Chart)								
			Black	Blue, Dark	Gold	Red	Silver	White	Black	Blue, Dark	Gold	Red	Silver	White			
BLACK, MIDNIGHT																	
Gold, Nevada (Metallic)	19	67									X						
Red, Apple	19	72			X	X									X		
Silver (Metallic)	19	17			X	X											X
White, Frost	19	12			X	X											
BLUE, GALAXY (Metallic)																	
Gold, Nevada (Metallic)	28	67	X										X				
Silver (Metallic)	28	17	X									X					
White, Frost	28	12	X														X
BLUE, LIGHT (Metallic)																	
Black, Midnight	21	19	X			X				X							
Blue, Galaxy (Metallic)	21	28	X								X						
Silver (Metallic)	21	17	X			X									X		
White, Frost	21	12	X														X
BRONZE, INDIAN (Metallic)																	
Gold, Nevada (Metallic)	66	67							X				X				
Silver (Metallic)	66	17				X									X		
White, Frost	66	12						X									X
EMERALD (Metallic)																	
Gold, Nevada (Metallic)	44	67							X				X				
White, Frost	44	12				X	X										X
GOLD, NEVADA (Metallic)																	
Black, Midnight	67	19			X	X		X									
White, Frost	67	12					X	X									X
GRAY, STEEL (Metallic)																	
Black, Midnight	90	19			X	X		X									
Blue, Galaxy (Metallic)	90	28	X			X				X							
Red, Apple	90	72			X	X						X					
Silver (Metallic)	90	17	X		X	X									X		
White, Frost	90	12	X			X											X
RED, APPLE																	
Black, Midnight	72	19			X	X		X									
Silver (Metallic)	72	17			X	X										X	
White, Frost	72	12			X												X
TAN, DOESKIN																	
Black, Midnight	61	19				X		X			X						
Blue, Galaxy (Metallic)	61	28	X								X						
Red, Apple	61	72			X									X			
White, Frost	61	12				X											X
WHITE, FROST																	
Black, Midnight	12	19			X	X		X									
Blue, Galaxy (Metallic)	12	28	X							X							
Gold, Nevada (Metallic)	12	67				X	X				X				X		
Red, Apple	12	72			X	X										X	
Silver (Metallic)	12	17	X		X	X										X	

*With YC2 Tahoe, rear seat trim is Special Custom Cloth, with YC3 Sport, rear seat trim is Deluxe Cloth.

S-10 BLAZER 2- & 4-WHEEL DRIVE

INTERIOR AND EXTERIOR COLOR AVAILABILITY CHART

WITH D90 SUNSHINE STRIPING

Please Note: Below are the interior trim color and exterior paint combinations recommended by Chevrolet. The only available color code 1/color code 2 exterior color combinations are those shown in the chart below; however, any available interior trim color may be ordered with one of these exterior color combinations if that particular combination is desired by the customer.

TRIM LEVEL Seat Type	Decor	INTERIOR COLORS			
		Blue	Carmine	Charcoal	Saddle Tan
STANDARD INTERIOR Custom Vinyl High Back Bucket Seats	Std.	XDD4	XRR4	XJJ4	XSS4
TAHOE Custom Vinyl High Back Bucket Seats	YC2	XDD4	XRR4	XJJ4	XSS4
Special Custom Cloth High Back Bucket Seats		HDD4	HRR4	HJJ4	HSS4
High Country Sheepskin High Back Bucket Seats					* BSS4
Leather High Back Reclining Bucket Seats				AJJ6	ASS6
SPORT (Reqs ZY6 or ZY7 Paint) Deluxe Cloth High Back Bucket Seats	YC3			DJJ4	DSS4
High Country Sheepskin High Back Bucket Seats					* BSS4
Leather High Back Reclining Bucket Seats				AJJ6	ASS6

EXTERIOR COLORS w/ZY1 PAINT	Color Code 1	Color Code 2	RECOMMENDED INTERIOR TRIM COLORS				STRIPE COLORS				
			Blue	Carmine	Charcoal	Saddle Tan	Black 19A	Gold 67A	Silver 17A	White 12A	Gray 90A
BLACK, MIDNIGHT	19	19	N/A	N/A	X	N/A	N/A	X	X	X	X
BLACK, MIDNIGHT	19	19		X	N/A	N/A	N/A	N/A	X	X	X
BLACK, MIDNIGHT	19	19	N/A	N/A	N/A	X	N/A	X	N/A	X	N/A
BLUE, GALAXY (Metallic)	28	28	X		X	X	N/A	N/A	X	X	N/A
BLUE, LIGHT (Metallic)	21	21	X		X		X	N/A	N/A	X	N/A
BRONZE, INDIAN (Metallic)	66	66			X	N/A	N/A	X	X	X	N/A
BRONZE, INDIAN (Metallic)	66	66	N/A	N/A	N/A	X	N/A	X	N/A	X	N/A
EMERALD (Metallic)	44	44			X	X	N/A	X	N/A	N/A	N/A
GOLD, NEVADA (Metallic)	67	67			X	X	X	N/A	N/A	N/A	N/A
GRAY, STEEL (Metallic)	90	90	X	X	X		X	N/A	N/A	X	N/A
RED, APPLE	72	72		X	X		X	N/A	X	X	X
TAN, DOESKIN	61	61			X	X	X	N/A	N/A	X	X
WHITE, FROST	12	12	X	X	X	N/A	X	N/A	X	N/A	X
WHITE, FROST	12	12	N/A	N/A	N/A	X	X	N/A	N/A	N/A	N/A

w/ZY6 PAINT	STRIPE COLORS (Stripe colors cannot be changed)			
	Black	Gold	Gray	White
BLACK, MIDNIGHT				
Gold, Nevada (Metallic)	19	67	N/A	N/A
Silver (Metallic)	19	17	N/A	X
Red, Apple	19	72	N/A	X
White, Frost	19	12	N/A	X
GOLD, NEVADA (Metallic)				
Black, Midnight	67	19	N/A	N/A
GRAY, STEEL (Metallic)				
Black, Midnight	90	19		X
Blue, Galaxy (Metallic)	90	28	X	N/A
Red, Apple	90	72	N/A	X
Silver (Metallic)	90	17	X	N/A
White, Frost	90	12	X	N/A
WHITE, FROST				
Black, Midnight	12	19	N/A	X
Blue, Galaxy (Metallic)	12	28	X	N/A
Gold, Nevada (Metallic)	12	67		X
Silver (Metallic)	12	17	X	N/A
Red, Apple	12	72	N/A	X

N/A-Not Available

*With YC2 Tahoe, rear seat trim is Special Custom Cloth, with YC3 Sport, rear seat trim is Deluxe Cloth.

S-10 BLAZER 2- & 4-WHEEL DRIVE

INTERIOR AND EXTERIOR COLOR AVAILABILITY CHART

WITH D98 RALLY STRIPING

Please Note: Below are the interior trim color and exterior paint combinations recommended by Chevrolet. The only available color code 1/color code 2 exterior color combinations are those shown in the chart below; however, any available interior trim color may be ordered with one of these exterior color combinations if that particular combination is desired by the customer.

TRIM LEVEL Seat Type	Decor	INTERIOR COLORS			
		Blue	Carmine	Charcoal	Saddle Tan
STANDARD INTERIOR Custom Vinyl High Back Bucket Seats	Std.	XDD4	XRR4	XJJ4	XSS4
TAHOE Custom Vinyl High Back Bucket Seats	YC2	XDD4	XRR4	XJJ4	XSS4
Special Custom Cloth High Back Bucket Seats		HDD4	HRR4	HJJ4	HSS4
High Country Sheepskin High Back Bucket Seats					*BSS4
Leather High Back Reclining Bucket Seats			AJJ6	ASS6	

EXTERIOR COLORS W/ZY1 PAINT	Color Code 1	Color Code 2	RECOMMENDED INTERIOR TRIM COLORS			STRIPE COLORS						
			Black 19A	Dk. Blue 28A	Gold 67A	Red 72A	Silver 17A	White 12A				
BLACK, MIDNIGHT	19	19			X						X	
BLACK, MIDNIGHT	19	19						X				
BLACK, MIDNIGHT	19	19		X					X			
BLUE, GALAXY (Metallic)	28	28	X		X				N/A		X	
BLUE, GALAXY (Metallic)	28	28						X				
BLUE, LIGHT (Metallic)	21	21	X		X				X		N/A	
BRONZE, INDIAN (Metallic)	66	66			X				N/A		N/A	
BRONZE, INDIAN (Metallic)	66	66					X		N/A		N/A	
EMERALD (Metallic)	44	44			X	X			N/A		N/A	N/A
GOLD, NEVADA (Metallic)	67	67			X	X			X		N/A	N/A
GRAY, STEEL (Metallic)	90	90			X				X		N/A	
GRAY, STEEL (Metallic)	90	90	X						X		N/A	
GRAY, STEEL (Metallic)	90	90		X							N/A	
RED, APPLE	72	72			X				X		N/A	
RED, APPLE	72	72		X							N/A	
TAN, DOESKIN	61	61			X				X		N/A	N/A
TAN, DOESKIN	61	61						X			N/A	N/A
WHITE, FROST	12	12			X				X			N/A
WHITE, FROST	12	12	X						X			N/A
WHITE, FROST	12	12						X				N/A
WHITE, FROST	12	12		X							X	N/A

D98 STRIPING CHART
RECOMMENDED COMBINATIONS
 Stripe color options must be specified on all ZY1 Solid Paint applications. Additional stripe combinations are available except where N/A is shown provided the dealer orders (D60) as verification.

N/A-Not Available

*With YC2 Tahoe, rear seat trim is Special Custom Cloth.

S-10 BLAZER 2- & 4-WHEEL DRIVE STRIPING CHART FOR ZY6 CUSTOM TWO-TONE

INTERIOR TRIM COLOR			BLUE	CARMINE	CHARCOAL	SADDLE TAN
EXTERIOR PAINT COLOR	Color Code 1	Color Code 2	STRIPE COLORS			
BLACK, MIDNIGHT/Gold, Nevada (Met)	19	67	*Orange/Yellow	*Orange/Yellow	Orange/Yellow	Orange/Yellow
BLACK, MIDNIGHT/Red, Apple	19	72	*Silver	Silver	Silver	*Silver
BLACK, MIDNIGHT/Silver (Met)	19	17	*Blue	Blue	Blue	*Red
BLACK, MIDNIGHT/White, Frost	19	12	*Blue	Red	Red	*Gold
BLUE, GALAXY (MET)/Gold, Nevada (Met)	28	67	Orange/Yellow	*Orange/Yellow	*Orange/Yellow	Orange/Yellow
BLUE, GALAXY (MET)/Silver (Met)	28	17	Blue	*Red	*Blue	*Blue
BLUE, GALAXY (MET)/White, Frost	28	12	Blue	*Red	*Blue	*Blue
BLUE, LIGHT (MET)/Black, Midnight	21	19	Blue	*Blue	Blue	*Blue
BLUE, LIGHT (MET)/Blue, Galaxy (Met)	21	28	Blue	*Silver	*Silver	*Blue
BLUE, LIGHT (MET)/Silver (Met)	21	17	Blue	*Blue	Blue	*Blue
BLUE, LIGHT (MET)/White, Frost	21	12	Blue	*Red	*Blue	*Blue
BRONZE, INDIAN (MET)/Gold, Nevada (Met)	66	67	*Orange/Yellow	*Orange/Yellow	*Orange/Yellow	Orange/Yellow
BRONZE, INDIAN (MET)/Silver (Met)	66	17	*Orange/Yellow	*Orange/Yellow	Orange/Yellow	*Orange/Yellow
BRONZE, INDIAN (MET)/White, Frost	66	12	*Orange/Yellow	*Orange/Yellow	*Orange/Yellow	Orange/Yellow
EMERALD (MET)/Gold, Nevada (Met)	44	67	*Gold	*Gold	*Gold	Gold
EMERALD (MET)/White, Frost	44	12	*Gold	*Gold	Gold	Gold
✓ GOLD, NEVADA (MET)/Black, Midnight	67	19	*Gold	*Gold	Gold	Gold
✓ GOLD, NEVADA (MET)/White, Frost	67	12	*Orange/Yellow	*Gold	*Orange/Yellow	Gold
GRAY, STEEL (MET)/Black, Midnight	90	19	*Blue	Red	Red	*Silver
GRAY, STEEL (MET)/Blue, Galaxy (Met)	90	28	Blue	*Silver	Silver	*Silver
GRAY, STEEL (MET)/Red, Apple	90	72	*Silver	Silver	Silver	*Silver
GRAY, STEEL (MET)/Silver (Met)	90	17	Blue	Red	Red	*Red
GRAY, STEEL (MET)/White, Frost	90	12	Blue	*Red	Blue	*Blue
RED, APPLE/Black, Midnight	72	19	*Silver	Red	Silver	*Red
RED, APPLE/Silver (Met)	72	17	*Red	Red	Red	*Red
RED, APPLE/White, Frost	72	12	*Silver	Silver	*Silver	*Gold
TAN, DOESKIN/Black, Midnight	61	19	*Orange/Yellow	*Orange/Yellow	Orange/Yellow	*Orange/Yellow
TAN, DOESKIN/Blue, Galaxy (Met)	61	28	Blue	*Blue	*Blue	*Blue
TAN, DOESKIN/Red, Apple	61	72	*Red	Red	*Red	*Red
TAN, DOESKIN/White, Frost	61	12	*Red	*Red	Red	*Red
WHITE, FROST/Black, Midnight	12	19	*Blue	Red	Red	*Gold
WHITE, FROST/Blue, Galaxy (Met)	12	28	Blue	*Blue	*Blue	*Blue
WHITE, FROST/Gold, Nevada (Met)	12	67	*Orange/Yellow	*Orange/Yellow	Orange/Yellow	Orange/Yellow
WHITE, FROST/Red, Apple	12	72	*Silver	Silver	Silver	*Gold
WHITE, FROST/Silver (Met)	12	17	Blue	Red	Red	*Red

*Stripe color/trim color combination available but not recommended.

MODEL AND BODY

Description	Model No	Body	Wheelbase
2-WHEEL-DRIVE GASOLINE MODELS			
≠Tailgate	CS10516	E55	100.5"

Description	Model No	Body	Wheelbase
4-WHEEL-DRIVE GASOLINE MODELS			
≠Tailgate	CT10516	E55	100.5"

≠Reqs N40 Power Steering or N51
Power Steering Not Desired And AM7 Folding Seat
or YG4 Seat Not Desired

EMISSIONS (MUST ORDER ONE)

- _____ NA5 Standard Emission Equipment
- _____ NA6 High Altitude Emission Equipment
- _____ YF5 California Emission Requirements

✓ POWER TEAMS (MUST ORDER ENGINE, TRANSMISSION AND REAR AXLE)

	ENGINE	TRANSMISSION			AXLE			
		4-SP	5-SP	AUTO	3.08	3.42	3.73	4.11
W/NA5 STANDARD EMISSION EQUIPMENT								
—S10516								
LN8 L4 2.5 Liter EFI	MM4		MX0	—	—	GQ1	H04	
		MM5		—	—	—	GQ1	
LL2 V6 2.8 Liter EFI (Reqs N40 Steering)	MM4			GQ1	GU6	—	—	
		MM5		—	GQ1	GT4	—	
			MX0	—	GQ1	GT4	—	
—T10516								
LN8 L4 2.5 Liter EFI	MM4			—	—	*GQ1	\$H04	
		MM5	MX0	—	—	—	GQ1	
LL2 V6 2.8 Liter EFI (Reqs N40 Steering)	MM4			—	*GQ1	GT4	—	
		MM5	MX0	—	—	*GQ1	H04	
W/NA6 HIGH ALTITUDE EMISSION EQUIPMENT								
—S10516								
LN8 L4 2.5 Liter EFI	MM4	MM5	MX0	—	—	—	GQ1	
LL2 V6 2.8 Liter EFI (Reqs N40 Steering)	MM4		MX0	—	—	GQ1	—	
		MM5		—	—	—	GQ1	
—T10516								
LN8 L4 2.5 Liter EFI	MM4	MM5	MX0	—	—	—	GQ1	
LL2 V6 2.8 Liter EFI (Reqs N40 Steering)	MM4			—	—	*GQ1	\$H04	
		MM5	MX0	—	—	*GQ1	H04	
W/YF5 CALIFORNIA EMISSION REQUIREMENTS								
—S10516								
LN8 L4 2.5 Liter EFI	MM4		MX0	—	—	GQ1	H04	
		MM5		—	—	—	GQ1	
LL2 V6 2.8 Liter EFI (Reqs N40 Steering)	MM4		MX0	—	GQ1	GT4	—	
		MM5		—	—	GQ1	H04	
—T10516								
LN8 L4 2.5 Liter EFI	MM4			—	—	*GQ1	\$H04	
		MM5	MX0	—	—	—	GQ1	
LL2 V6 2.8 Liter EFI (Reqs N40 Steering)	MM4			—	—	*GQ1	\$H04	
		MM5	MX0	—	—	*GQ1	H04	

*N/A P235/75R15 Tires
\$Reqs P235/75R15 Tires

S-10 SPORT

FEATURE OPTION: YC3

Sport Equipment (Reqs ZY6 or ZY7 Paint) (Incls Lower Body Color Front and Rear Bumpers w/Rub Strips, Reclining Seat Backs and Console, Gage Package with Trip Odometer, Spare Tire Cover, Visor Mirror, Body Side Midgs, and Black Wheel Opening Midgs) (Incls Rally Wheels on S10) (Incls Wheel Trim Rings on T10)

QUICK-SPEC (OPTIONAL)

EMISSION, ENGINE, TRANSMISSION, AXLE AND TIRE MUST BE ENTERED AS ADDITIONS TO THESE QUICK-SPECS.		B S A 1	B S A 2	B S A 3
Sport Equipment	YC3	x	x	x
Air Conditioning	C60	x	x	x
Body: Standard	E55	x	x	x
Mirrors: Black	D44	x	x	x
Preliminary Price Information	B3W	x	x	x
Radio: ETR AM/FM Stereo	UU9	x	N/I	N/I
Seat: Rear, Folding	AM7	x	x	x
Steering: Power	N40	x	x	x
Steering Wheel: Comfortilt	N33	x	x	x
Tank, Fuel	NK2	x	x	x
Battery: Heavy-Duty	UA1		x	x
Deflector, Air	C51		x	x
Defogger, Rear Window	C49		x	x
Floor Coverings: Front	B32		x	x
Floor Coverings: Rear	B33		x	x
Radio: ETR AM/FM Stereo w/Seek-Scan, Stereo Cassette Tape & Clock	UM6		x	N/I
Speed Control, Electronic	K34		x	x
Tailgate Window Release: Power	AU6		x	x
Windshield Wiper System	CD4		x	x
Carrier, Luggage	V54			x
Headlamps, Halogen	TT4			x
Lamp, Engine Compartment	U26			x
Operating Convenience Pkg	ZQ2			x
Radio: ETR AM Stereo/FM Stereo w/Seek-Scan, Stereo Cassette Tape, Graphic Equalizer & Clock	UX1			x
Shield: Transfer Case (T10 only)	NY7			x
Wheels: Aluminum, Cast (T10 only)	N90			x

PLEASE REVIEW OPTION RESTRICTIONS BEFORE ORDERING

Q-S	OPTION
(1)	K46 AIR CLEANER: (Reqs LL2 Eng)
(1)	C60 AIR CONDITIONING: (Reqs N40 Steering) (w/o V02 Cooling Incls V01 Cooling)
(2)	G80 AXLE, REAR: Locking Differential
(2)	UA1 BATTERY: Heavy-Duty, 630 Cold Cranking Amps Delco Freedom (Incl w/V10 Cold Climate)
(3)	V28 BUMPER EQUIPMENT: Bumper Guards, Front only, Black
(3)	V54 CARRIER, LUGGAGE: Painted, Black
(3)	P16 CARRIER, SPARE WHEEL AND TIRE: (Incls Exterior Cover) (Reqs Full Size Spare Tire)
(3)	Z71 CHASSIS EQUIPMENT: Off Road Package (T10 only) (N/A F51 Shocks) (Reqs QEB Tires) (Incls NY7 Shield, V76 Tow Hooks and ZK5 Spare)
(3)	V10 COLD-CLIMATE PACKAGE: (Incls UA1 Battery)
(3)	COOLING SYSTEM: Heavy-Duty
(3)	Engine Oil Cooler (S10 only) (Reqs LL2 Eng, MX0 Trans and V01 or V02 Cooling)
(3)	V01 Radiator (N/A V02 Cooling) (Incl w/C60 Air)
(3)	V02 Radiator and Transmission Oil Cooler (Reqs LL2 Eng and MX0 Trans)
(2)	C51 DEFLECTOR, AIR
(2)	C49 DEFOGGER, REAR WINDOW: Electric
(2)	AU3 DOOR LOCK SYSTEM, POWER: Side Door (Incl w/ZQ2 Conv Pkg)
(2)	FLOOR COVERING:
(2)	BG9 Full Floor, Rubber Color-Keyed: (Replaces Carpeting) (N/A B32 or B33 Mats)
(2)	B32 Mats, Removable Color-Keyed: Front
(2)	B33 Mats, Removable Color-Keyed: Rear
(2)	U16 GAGE, TACHOMETER
(2)	GLASS:
(2)	AA3 Deep Tinted w/Light Tinted Rear Window (N/A AJ1 Glass)
(2)	AJ1 Deep Tinted
(2)	TT4 HEADLAMPS, HALOGEN
(2)	K05 HEATER, ENGINE BLOCK
(2)	YH9 HIGH COUNTRY PACKAGE: (T10 Only) (Incls AA3 Deep Tinted Glass and D44 Black Mirrors) (Reqs White Lettered Tires, ZK4 or ZK5 Spare, ZY6 Paint w/19 Black Midnight Color Code 1 and 67 Nevada Gold Metallic Color Code 2 Color Combination, and Saddle Tan Deluxe Cloth, Saddle Tan Sheepskin or Saddle Tan Leather Trim) (N/A B93 Midg or N90 Aluminum Wheel)
(3)	U26 LAMP: Engine Compartment
(1)	D44 MIRRORS: Exterior, Below-Eye-Line Type, Black

PLEASE REVIEW OPTION RESTRICTIONS BEFORE ORDERING

Q-S	OPTION
—	B93 MOLDINGS: Door Edge Guard (N/A YH9 Package)
(3)	ZQ2 OPERATING CONVENIENCE PACKAGE: (Incls AU3 Door Locks and A31 Windows)
(1)	B3W PRELIMINARY PRICE INFORMATION
	RADIO EQUIPMENT:
—	U63 AM Radio
—	U69 AM/FM Radio
(1)	UU9 Electronically Tuned AM/FM Stereo Radio
—	UM7 Electronically Tuned AM/FM Stereo Radio w/Seek-Scan and Digital Clock
(2)	UM6 Electronically Tuned AM/FM Stereo Radio w/Seek-Scan, Stereo Cassette Tape and Digital Clock (Incls U66 Speakers)
(3)	UX1 Electronically Tuned AM Stereo/FM Stereo Radio w/Seek-Scan, Stereo Cassette Tape with Search and Repeat, Graphic Equalizer and Digital Clock (Incls U66 Speakers)
—	U66 Speakers, Premium Dual Rear (Reqs UM7 or UU9 Radio) (Incl w/UM6 or UX1 Radio)
	SEATING: (MUST ORDER AM7 or YG4 Seat)
(1)	AM7 Rear, Folding 2-Passenger
—	YG4 Rear Seat Not Desired (N/A AM7 Seat)
(3)	NY7 SHIELD, TRANSFER CASE: (T10 only) (Incl w/Z71 Chassis Equip)
—	F51 SHOCK ABSORBERS: Front and Rear, Heavy-Duty (N/A Z71 Chassis Equip) (Incl w/F60 Susp)
	SPARE TIRE, FULL SIZE: (Replaces Standard Compact Spare)
—	ZK4 Highway/All-Seasons (N/A QEB, QJL or QJT Tires)
—	ZK5 On-Off Road (S10 Reqs QJL, QJT or Q1C Tires) (T10 Reqs QEB, QJL or QJT Tires) (Incl w/Z71 Chassis Equip)
(2)	K34 SPEED CONTROL, ELECTRONIC
	STEERING:
—	N51 Power Not Desired
(1)	N40 Power
(1)	N33 STEERING WHEEL: Comfortilt
—	D90 SUNSHINE STRIPING: (Reqs ZY6 Paint) (Refer Page 4 for Color and Trim Availability)
—	F60 SUSPENSION EQUIPMENT: Front, Heavy-Duty (T10 only) (N/A Z71 Chassis Equip) (Incls F51 Shocks) (Recommended for snowplow type usage only)
(2)	AU6 TAILGATE WINDOW RELEASE, POWER
(1)	NK2 TANK, FUEL: Approx 20 Gallons
	TIRES: (B/W: Blackwall, W/W: Whitewall, W/L: White Lettered) (Incls Compact Spare Tire)
—	QAR All-Seasons Steel Belted Radial Ply (Front and Rear)
—	QAS P195/75R-15 B/W (See Power Teams Chart For Axle Restrictions)
—	QCE P195/75R-15 W/W (See Power Teams Chart For Axle Restrictions)
—	QCF P205/75R-15 B/W
—	Q1C P205/75R-15 W/L
—	QJT Steel Belted Radial Ply (Front-Highway and Rear On-Off Road) (CS10516 only)
—	QJL P205/75R-15 B/W
—	QEB On-Off Road Steel Belted Radial Ply (Front and Rear) (N/A ZK4 Spare)
—	V76 P205/75R-15 B/W
—	VR2 P205/75R-15 W/L (CT10516 only) (Reqs ZK5 Spare) (See Power Teams Chart For Axle Restrictions)
—	Z72 TOWING DEVICE: Two Front Tow Hooks (T10 only) (Incl w/Z71 Chassis Equip)
✓	TRAILER HITCH: Deadweight Type (N/A Z82 Trailing) (Incl w/Z72 Trailing)
✓	Z82 TRAILERING PACKAGE: (N/A Z82 Trailing) (Reqs MX0 Trans and V01 or V02 Cooling or C60 Air) (w/LN8 Eng Reqs 4.11 Rear Axle)
✓	TRAILERING SPECIAL EQUIPMENT: Heavy-Duty (Reqs LL2 Eng, V02 Cooling, and N40 Steering) (S10 Reqs MX0 Trans and 3.73 Rear Axle) (T10 Reqs MX0 Trans and 4.11 Rear Axle) (Refer Trailering Guide)
—	N79 WHEEL, SPARE: Aluminum, Cast (T10 only) (Reqs N90 Wheels and ZK4 or ZK5 Spare)
(3)	N90 WHEELS: Aluminum, Cast (T10 only) (N/A QAR or QAS P195 Tires)
	WINDOWS:
—	A31 Power, Side Door (Incl w/ZQ2 Conv Pkg)
—	AD5 Sliding Side
(2)	CD4 WINDSHIELD WIPER SYSTEM: Intermittent

FEATURE OPTION: YC2

Tahoe Equipment (Incls Visor Mirror, Gage Package with Trip Odometer, Spare Tire Cover, Wheel Trim Rings, Black Body Side Mldgs. and Bright Wheel Opening Mldgs)

QUICK-SPEC (OPTIONAL)

EMISSION, ENGINE, TRANSMISSION, AXLE AND TIRE MUST BE ENTERED AS ADDITIONS TO THESE QUICK-SPECS		B T A 1	B T A 2	B T A 3
Tahoe Equipment	YC2	x	x	x
Air Conditioning	C60	x	x	x
Body: Standard	E55	x	x	x
Console	D55	x	x	x
Mirrors: Bright	D45	x	x	x
Preliminary Price Information	B3W	x	x	x
Radio: ETR AM/FM Stereo	UU9	x	N/1	N/1
Seat: Rear, Folding	AM7	x	x	x
Steering: Power	N40	x	x	x
Steering Wheel: Comfortit	N33	x	x	x
Tank, Fuel	NK2	x	x	x
Battery: Heavy-Duty	UA1		x	x
Deflector, Air	C51		x	x
Defogger, Rear Window	C49		x	x
Floor Coverings: Front	B32		x	x
Floor Coverings: Rear	B33		x	x
Radio: ETR AM/FM Stereo w/Seek-Scan, Stereo Cassette Tape & Clock	UM6		x	N/1
Speed Control, Electronic	K34		x	x
Tailgate Window Release: Power	AU6		x	x
Windshield Wiper System	CD4		x	x
Headlamps, Halogen	TT4			x
Lamp, Engine Compartment	U26			x
Operating Convenience Pkg	ZQ2			x
Radio: ETR AM Stereo/FM Stereo w/Seek-Scan, Stereo Cassette Tape, Graphic Equalizer & Clock	UX1			x
Shield: Transfer Case (T10 only)	NY7			x

PLEASE REVIEW OPTION RESTRICTIONS BEFORE ORDERING

Q-S	OPTION
(1)	K46 AIR CLEANER: (Reqs LL2 Eng)
	C60 AIR CONDITIONING: (Reqs N40 Steering) (w/o V02 Cooling Incls V01 Cooling)
	G80 AXLE, REAR: Locking Differential
(2)	UA1 BATTERY: Heavy-Duty, 630 Cold Cranking Amps Delco Freedom (Incl w/V10 Cold Climate)
	BUMPER EQUIPMENT:
	VE6 Bumpers, Front and Rear Color-Keyed w/Rub Strips (Reqs ZY6, ZY7 or ZY8 Paint)(Incl w/YH9 Package)
	V28 Bumper Guards, Front only, Black
	CARRIER, LUGGAGE:
	V54 Painted, Black
	V55 Bright (N/A YH9 Package)
	P16 CARRIER, SPARE WHEEL AND TIRE: (Incls Exterior Cover) (Reqs Full Size Spare Tire)
	Z71 CHASSIS EQUIPMENT: Off Road Package (T10 only) (N/A F51 Shocks) (Reqs QEB Tires) (Incls NY7 Shield, ZK5 Spare and V76 Tow Hooks)
	V10 COLD CLIMATE PACKAGE: (Incls UA1 Battery)
(1)	D55 CONSOLE (Incl w/YH9 Package)
	COOLING SYSTEM: Heavy-Duty
	KC4 Engine Oil Cooler (S10 only) (Reqs LL2 Eng, MX0 Trans and V01 or V02 Cooling)
	V01 Radiator (N/A V02 Cooling) (Incl w/C60 Air)
	V02 Radiator and Transmission Oil Cooler (Reqs LL2 Eng and MX0 Trans)
(2)	C51 DEFLECTOR, AIR
(2)	C49 DEFOGGER, REAR WINDOW: Electric
	AU3 DOOR LOCK SYSTEM, POWER: Side Door (Incl w/ZQ2 Conv Pkg)
	FLOOR COVERING:
	BG9 Full Floor, Rubber Color-Keyed: (Replaces Carpeting) (N/A B32 or B33 Mats)
(2)	B32 Mats, Removable Color-Keyed: Front
(2)	B33 Mats, Removable Color-Keyed: Rear
	U16 GAGE, TACHOMETER
	GLASS:
	AA3 Deep Tinted w/Light Tinted Rear Window (N/A AJ1 Glass) (Incl w/YH9 Package)
	AJ1 Deep Tinted
(3)	TT4 HEADLAMPS, HALOGEN
	K05 HEATER, ENGINE BLOCK
✓	YH9 HIGH COUNTRY PACKAGE: (T10 Only)(Incls A78 Seat Backs, AA3 Deep Tinted Glass, D44 Black Mirrors, D55 Console, VE6 Color-Keyed Bumpers, and Gold Painted Aluminum Cast Wheels) (Reqs White Lettered Tires, ZK4 or ZK5 Spare, ZY6 Paint w/19 Black Midnight Color Code 1 and 67 Nevada Gold Metallic Color Code 2 Color Combination, and Saddle Tan Special Custom Cloth, Saddle Tan Sheepskin or Saddle Tan Leather Trim)
(3)	U26 LAMP: Engine Compartment
	MIRRORS: Exterior, Below Eye-Line Type
	D44 Black (Incl w/YH9 Package)
(1)	D45 Bright
	MOLDINGS:
	B93 Door Edge Guard (N/A YH9 Package)
	B74 Wheel Opening, Black

PLEASE REVIEW OPTION RESTRICTIONS BEFORE ORDERING

Q-S	OPTION	
(3)	ZQ2	OPERATING CONVENIENCE PACKAGE: (Incls AU3 Door Locks and A31 Windows)
(1)	B3W	PRELIMINARY PRICE INFORMATION
		RADIO EQUIPMENT:
	U63	AM Radio
	U69	AM/FM Radio
(1)	UU9	Electronically Tuned AM/FM Stereo Radio
	UM7	Electronically Tuned AM/FM Stereo Radio w/Seek-Scan and Digital Clock
(2)	UM6	Electronically Tuned AM/FM Stereo Radio w/Seek-Scan, Stereo Cassette Tape and Digital Clock (Incls U66 Speakers)
(3)	UX1	Electronically Tuned AM Stereo/FM Stereo Radio w/Seek-Scan, Stereo Cassette Tape with Search and Repeat, Graphic Equalizer and Digital Clock (Incls U66 Speakers)
	U66	Speakers, Premium Dual Rear (Reqs UM7 or UU9 Radio) (Incl w/UM6 or UX1 Radio)
		SEATING: (MUST ORDER AM7 or YG4 Seat)
(1)	AM7	Rear, Folding, 2-Passenger
	YG4	Rear Seat Not Desired (N/A AM7 Seat)
	A78	SEAT EQUIPMENT: Seat Backs, Reclining (Incl w/YH9 Package)
(3)	NY7	SHIELD, TRANSFER CASE: (T10 only) (Incl w/Z71 Chassis Equip)
	F51	SHOCK ABSORBERS: Front and Rear, Heavy-Duty (N/A Z71 Chassis Equip) (Incl w/F60 Susp)
		SPARE TIRE, FULL SIZE: (Replaces Standard Compact Spare)
	ZK4	Highway (N/A QEB, QJL or QJT Tires)
	ZK5	On-Off Road (S10 Reqs QJL, QJT or Q1C Tires) (T10 Reqs QEB, QJL or QJT Tires) (Incl w/Z71 Chassis Equip)
(2)	K34	SPEED CONTROL, ELECTRONIC
		STEERING:
	N51	Power Not Desired
(1)	N40	Power
(1)	N33	STEERING WHEEL: Comfortilt
		STRIPING:
	D98	Rally (Reqs ZY1 Paint and Stripe Color) (Refer Page 5 for Striping)
	D90	Sunshine (Reqs ZY1 or ZY6 Paint) (w/ZY1 Paint Reqs Stripe Color) (Refer Page 4 for Striping)
	F60	SUSPENSION EQUIPMENT: Front, Heavy-Duty (T10 only) (N/A Z71 Chassis Equip) (Incls F51 Shocks) (Recommended for snowplow type usage only)
(2)	AU6	TAILGATE WINDOW RELEASE, POWER
(1)	NK2	TANK, FUEL: Approx 20 Gallons
		TIRES: (B/W: Blackwall, W/W: Whitewall, W/L: White Lettered) (Incls Compact Spare Tire)
		All-Seasons Steel Belted Radial Ply (Front and Rear)
	QAR	P195/75R-15 B/W (See Power Teams Chart For Axle Restrictions)
	QAS	P195/75R-15 W/W (See Power Teams Chart For Axle Restrictions)
	QCE	P205/75R-15 B/W
	QCF	P205/75R-15 W/L
		Steel Belted Radial Ply (Front-Highway and Rear On-Off Road) (CS10516 only)
	Q1C	P205/75R-15 B/W
		On-Off Road Steel Belted Radial Ply (Front and Rear) (N/A ZK4 Spare)
	QJT	P205/75R-15 B/W
	QJL	P205/75R-15 W/L
	QEB	P235/75R-15 W/L (CT10516 only) (Reqs ZK5 Spare) (See Power Teams Chart for Axle Restrictions)
	V76	TOWING DEVICE: Two Front Tow Hooks (T10 only) (Incl w/Z71 Chassis Equip)
	VR2	TRAILER HITCH: Deadweight Type (N/A Z82 Trailering) (Incl w/Z72 Trailering)
✓	Z72	TRAILERING PACKAGE: (N/A Z82 Trailering) (Reqs MX0 Trans and V01 or V02 Cooling or C60 Air) (w/LN8 Eng Reqs 4.11 Rear Axle)
✓	Z82	TRAILERING SPECIAL EQUIPMENT: Heavy-Duty (Reqs LL2 Eng, V02 Cooling and N40 Steering) (S10 Reqs MX0 Trans and 3.73 Rear Axle) (T10 Reqs MX0 Trans and 4.11 Rear Axle) (Refer Trailering Guide)
	N79	WHEEL, SPARE: Aluminum, Cast (T10 only) (Reqs N90 Wheels and ZK4 or ZK5 Spare)
		WHEELS:
	N90	Aluminum, Cast (T10 only) (N/A QAR or QAS P195 Tires) (N/A YH9 Package)
	ZJ7	Rally (S10 only)
		WINDOWS:
	A31	Power, Side Door (Incl w/ZQ2 Conv Pkg)
	AD5	Sliding Side
(2)	CD4	WINDSHIELD WIPER SYSTEM: Intermittent

QUICK-SPEC (OPTIONAL)

**EMISSION, ENGINE, TRANSMISSION,
AXLE AND TIRE MUST BE
ENTERED AS ADDITIONS TO
THESE QUICK-SPECS.**

		B	B	B
		B	B	B
		A	A	A
		1	2	3
Body: Standard	E55	x	x	x
Console	D55	x	x	x
Gages: Volt, Temp and Oil Pressure w/Trip Odometer	Z53	x	x	x
Preliminary Price Information	B3W	x	x	x
Radio: ETR AM/FM Stereo	UU9	x	x	N/I
Seat: Rear, Folding	AM7	x	x	x
Steering: Power	N40	x	x	x
Tank, Fuel	NK2	x	x	x
Air Conditioning	C60		x	x
Battery: Heavy-Duty	UA1		x	x
Mirrors: Bright	D45		x	x
Shield: Transfer Case (T10 only)	NY7		x	x
Steering Wheel: Comfortilt	N33		x	x
Deflector, Air	C51			x
Defogger, Rear Window	C49			x
Moldings: Body Side and Wheel Opening	B84			x
Radio: ETR AM/FM Stereo w/Seek-Scan, Stereo Cassette				
Tape & Clock	UM6			x
Speed Control, Electronic	K34			x
Tailgate Window Release: Power	AU6			x
Wheel Trim: Trim Rings	P06			x

PLEASE REVIEW OPTION RESTRICTIONS BEFORE ORDERING

Q-S OPTION

- K46 **AIR CLEANER:** (Reqs LL2 Eng)
- (2) C60 **AIR CONDITIONING:** (Reqs N40 Steering) (w/o V02 Cooling Incls V01 Cooling)
- G80 **AXLE, REAR:** Locking Differential
- (2) UA1 **BATTERY:** Heavy-Duty, 630 Cold Cranking Amps Delco Freedom (Incl w/V10 Cold Climate)
- VE6 **BUMPER EQUIPMENT:**
Bumpers, Front and Rear Color-Keyed w/Rub Strips (Reqs ZY6, ZY7 or ZY8 Paint)
- V28 Bumper Guards, Front only. Black
- V54 **CARRIER, LUGGAGE:**
Painted. Black
- V55 Bright
- P16 **CARRIER, SPARE WHEEL AND TIRE:** (N/A P17 Cover) (Incls Exterior Cover) (Reqs Full Size Spare Tire)
- Z71 **CHASSIS EQUIPMENT:** Off Road Package (T10 only) (N/A F51 Shocks) (Reqs QEB Tires) (Incls NY7 Shield, V76 Tow Hooks, ZK5 Spare and P06 Trim Rings)
- V10 **COLD CLIMATE PACKAGE:** (Incls UA1 Battery)
- (1) D55 **CONSOLE**
- ✓ **COOLING SYSTEM:** Heavy-Duty
— KC4 Engine Oil Cooler (S10 only) (Reqs LL2 Eng, MX0 Trans and V01 or V02 Cooling)
- V01 Radiator (N/A V02 Cooling) (Incl w/C60 Air)
- V02 Radiator and Transmission Oil Cooler (Reqs LL2 Eng and MX0 Trans)
- P17 **COVER, SPARE TIRE:** (N/A P16 Carrier)
- (3) C51 **DEFLECTOR, AIR**
- (3) C49 **DEFOGGER, REAR WINDOW:** Electric
- AU3 **DOOR LOCK SYSTEM, POWER:** Side Door (Incl w/ZQ2 Conv Pkg)
- **GAGES:**
— U16 Gage, Tachometer (Incls Z53 Gages)
- (1) Z53 Voltmeter, Temperature and Oil Pressure w/Trip Odometer (Incl w/U16 Gage)
- **GLASS:**
— AA3 Deep Tinted w/Light Tinted Rear Window (N/A AJ1 Glass)
- AJ1 Deep Tinted
- TT4 **HEADLAMPS, HALOGEN**
- K05 **HEATER, ENGINE BLOCK**
- U26 **LAMP:** Engine Compartment
- **MIRRORS:**
— D34 Visor
- D44 Exterior, Below Eye-Line Type. Black
- (2) D45 Exterior, Below Eye-Line Type. Stainless Steel

PLEASE REVIEW OPTION RESTRICTIONS BEFORE ORDERING

Q-S	OPTION	
		MOLDINGS:
(3)	B84	Body Side and Wheel Opening (Incl w/ZY8 Paint) (Incls B96 Mldgs)
—	B93	Door Edge Guard
—	B74	Wheel Opening, Black (N/A B96 Mldgs)
—	B96	Wheel Opening, Bright (Incl w/B84 Mldgs)
—	ZQ2	OPERATING CONVENIENCE PACKAGE: (Incls AU3 Door Locks and A31 Windows)
(1)	B3W	PRELIMINARY PRICE INFORMATION
		RADIO EQUIPMENT:
—	U63	AM Radio
—	U69	AM/FM Radio
(1)	UU9	Electronically Tuned AM/FM Stereo Radio
—	UM7	Electronically Tuned AM/FM Stereo Radio w/Seek-Scan and Digital Clock
(3)	UM6	Electronically Tuned AM/FM Stereo Radio w/Seek-Scan, Stereo Cassette Tape and Digital Clock (Incl. U66 Speakers)
—	UX1	Electronically Tuned AM Stereo/FM Stereo Radio w/Seek-Scan, Stereo Cassette Tape with Search ar Repeat, Graphic Equalizer and Digital Clock (Incls U66 Speakers)
—	U66	Speakers, Premium Dual Rear (Reqs UM7 or UU9 Radio) (Incl w/UM6 or UX1 Radio)
		SEATING: (MUST ORDER AM7 or YG4 Seat)
(1)	AM7	Rear, Folding, 2-Passenger
—	YG4	Rear Seat Not Desired (N/A AM7 Seat)
—	A78	SEAT EQUIPMENT: Seat Backs, Reclining
(2)	NY7	SHIELD, TRANSFER CASE: (T10 only) (Incl w/Z71 Chassis Equip)
—	F51	SHOCK ABSORBERS: Front and Rear, Heavy-Duty (N/A Z71 Chassis Equip) (Incl w/F60 Susp)
—	ZK4	SPARE TIRE, FULL SIZE: (Replaces Standard Compact Spare)
—	ZK5	Highway (N/A QEB, QJL or QJT Tires)
(3)	K34	On-Off Road (S10 Reqs QJL, QJT or Q1C Tires) (T10 Reqs QEB, QJL or QJT Tires) (Incl w/Z71 Chassis Equip)
		SPEED CONTROL, ELECTRONIC
		STEERING:
—	N51	Power Not Desired
(1)	N40	Power
(2)	N33	STEERING WHEEL: Comfortilt
—	D85	STRIPING: (Refer Color and Trim Chart for Availability)
—	D98	Body (Reqs ZY1 Paint) (Stripe Color Incl w/ZY7 Paint) (N/A B84 Moldings) (Refer Pages 2 and 3 for Striping)
—	D90	Rally (Reqs ZY1 Paint and Stripe Color) (Refer Page 5 for Striping)
—	F60	Sunshine (Reqs ZY1 or ZY6 Paint) (w/ZY1 Paint Reqs Stripe Color) (Refer Page 4 for Striping)
(3)	AU6	SUSPENSION EQUIPMENT: Front, Heavy-Duty (T10 only) (N/A Z71 Chassis Equip) (Incls F51 Shocks)
(1)	NK2	(Recommended for snowplow type usage only)
		TAILGATE WINDOW RELEASE, POWER
		TANK, FUEL: Approx 20 Gallons
		TIRES: (B/W: Blackwall, W/W: Whitewall, W/L: White Lettered) (Incls Compact Spare Tire)
—	QAR	All-Seasons Steel Belted Radial Ply (Front and Rear)
—	QAS	P195/75R-15 B/W (See Power Teams Chart For Axle Restrictions)
—	QCE	P195/75R-15 W/W (See Power Teams Chart For Axle Restrictions)
—	QCF	P205/75R-15 B/W
—	Q1C	P205/75R-15 W/L
—	QJT	Steel Belted Radial Ply (Front-Highway and Rear On-Off Road) (CS10516 only)
—	QJL	P205/75R-15 B/W
—	QEB	On-Off Road Steel Belted Radial Ply (Front and Rear) (N/A ZK4 Spare)
—	V76	P205/75R-15 B/W
—	VR2	P205/75R-15 W/L
—	Z72	P235/75R-15 W/L (CT10516 only) (See Power Teams Chart For Axle Restrictions) (Reqs ZK5 Spare)
—		TOWING DEVICE: Two Front Tow Hooks (T10 only) (Incl w/Z71 Chassis Equip)
—		TRAILER HITCH: Deadweight Type (N/A Z82 Trailing) (Incl w/Z72 Trailing)
✓	Z82	TRAILERING PACKAGE: (N/A Z82 Trailing) (Reqs MX0 Trans and V01 or V02 Cooling or C60 Air) (w/LN8 Eng Reqs 4.11 Rear Axle)
✓	Z82	TRAILERING SPECIAL EQUIPMENT: Heavy-Duty (Reqs LL2 Eng, V02 Cooling and N40 Steering) (S10 Reqs MX0 Trans and 3.73 Rear Axle) (T10 Reqs MX0 Trans and 4.11 Rear Axle) (Refer Trailing Guide)
—	N79	WHEEL, SPARE: Aluminum, Cast (T10 only) (Reqs N90 Wheels and ZK4 or ZK5 Spare)
(3)	P06	WHEEL TRIM: Trim Rings (Incl w/Z71 Chassis Equip)
		WHEELS:
—	N90	Aluminum, Cast (T10 only) (N/A QAR or QAS P195 Tires)
—	ZJ7	Rally (S10 only)
		WINDOWS:
—	A31	Power, Side Door (Incl w/ZQ2 Conv Pkg)
—	AD5	Sliding Side
—	CD4	WINDSHIELD WIPER SYSTEM: Intermittent

NOTES

S-10/15 BLAZER/JIMMY 2- & 4-WHEEL DRIVE

**CAB & BODY FEATURES
SEATING ARRANGEMENTS
CAB DIMENSIONS
COLOR & TRIM CHARTS
TWO-TONES**

S-10/15 BLAZER/JIMMY 2- & 4-WHEEL DRIVE

STANDARD MODEL—FEATURES

The standard models include the following items as standard equipment

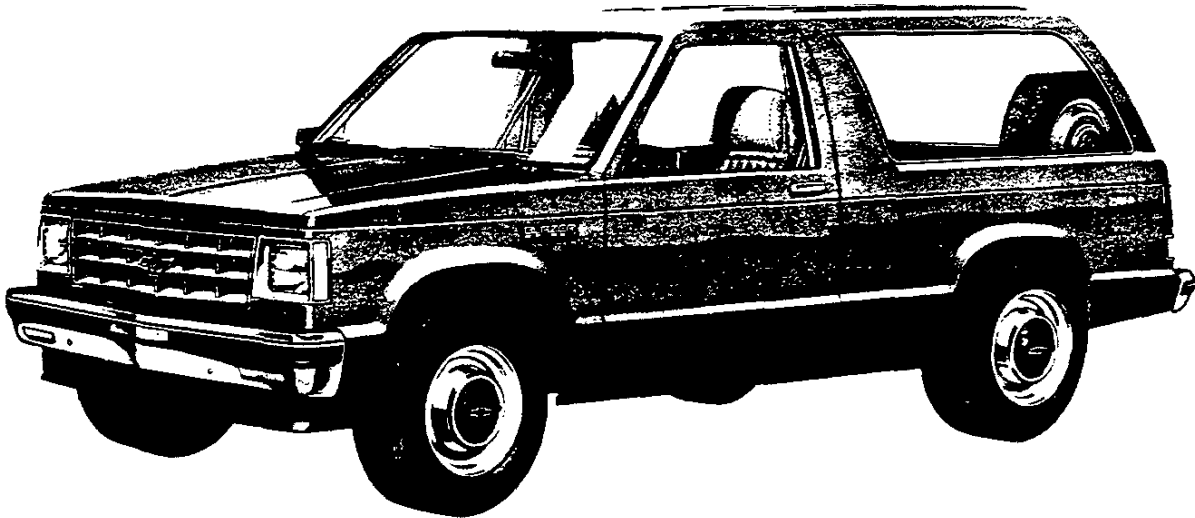

EXTERIOR

- **Bumper:** Front and rear, chromed with black rub strips; front bumper incorporates parking lamps
- **Color:** See Interior and Exterior Color Selection Chart
- **Endgate-Liftglass:** Single pivot hinges on endgate and liftglass; latches on each side of endgate and at center for liftglass; gas cylinders attached to the black metal glass frame operate liftglass and provide check; cable checks on endgate; lift handle on glass. Center Key operated lock releases liftglass when turned to the left and endgate latches when turned to the right.
- **Glass:** Tinted, all windows
- **Grille:** Molded plastic; chrome and black; integral Chevrolet emblem/GMC letters at center of grille
- **Headlamp-Parking Lamp Bezels:** Molded plastic with chromed finish and black trim
- **Horn:** Single, electric, high-note
- **Hub Caps:** Bright metal (2WD). Black trim on Chevrolet model. Black hub caps on 4x4 models
- **Keys:** Two-key system; with separate keys for ignition switch and door locks
- **Lettering, Endgate:** Black or silver decal on embossed Chevrolet/GMC letters depending on exterior color
- **Lights:**
 - Backup lamps: Two rear (integral with taillamps)
 - Combination parking/direction/hazard: Two front
 - Combination tail/stop/direction/hazard: Two rear
 - Headlamps: Two, rectangular
 - License plate lamp: Single rear
 - Side marker lamps with reflectors: Two front; two rear (integral with taillamps)
- **Mirrors:** RH and LH fixed arm with adjustable 6½" wide x 4" high aerodynamic heads; low gloss black finish. RH mirror is convex
- **Moldings:** Low-gloss black windshield and rear window
- **Nameplates:** Bright "Blazer/Jimmy" nameplates on front fenders near doors. Engine designation nameplate under LH headlamp. 4-wheel-drive models have a "4x4" nameplate mounted below the fender nameplate
- **Wheels:** Painted argent
- **Windshield Wipers and Washers:** Electric, 2-speed wipers with low-gloss black finish on exposed metal portions; coordinated washer with fluidic oscillator at center of plenum inlet grille

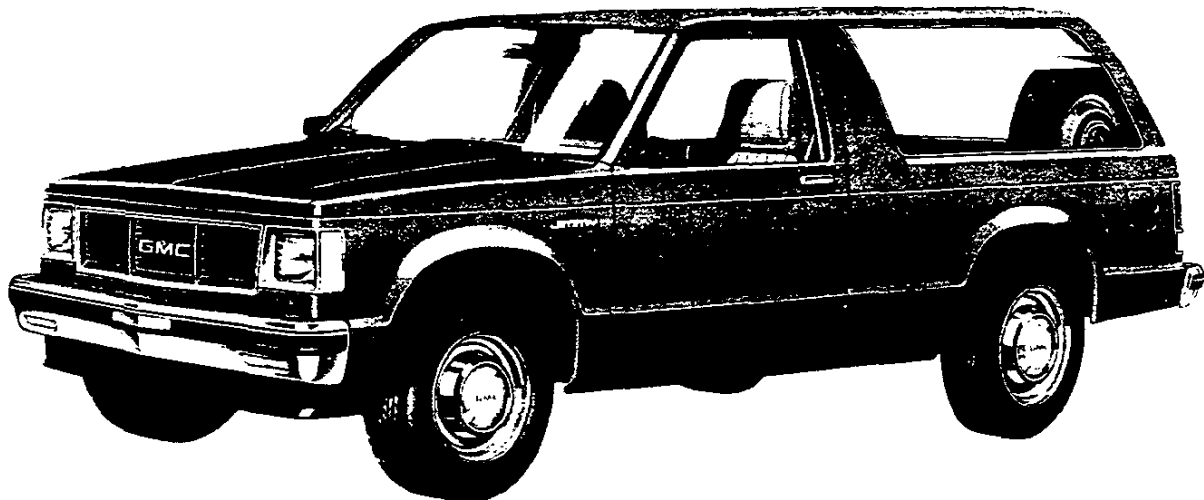

S-10/15 BLAZER/JIMMY 2- & 4-WHEEL DRIVE

STANDARD MODEL—FEATURES

The standard models include the following items as standard equipment

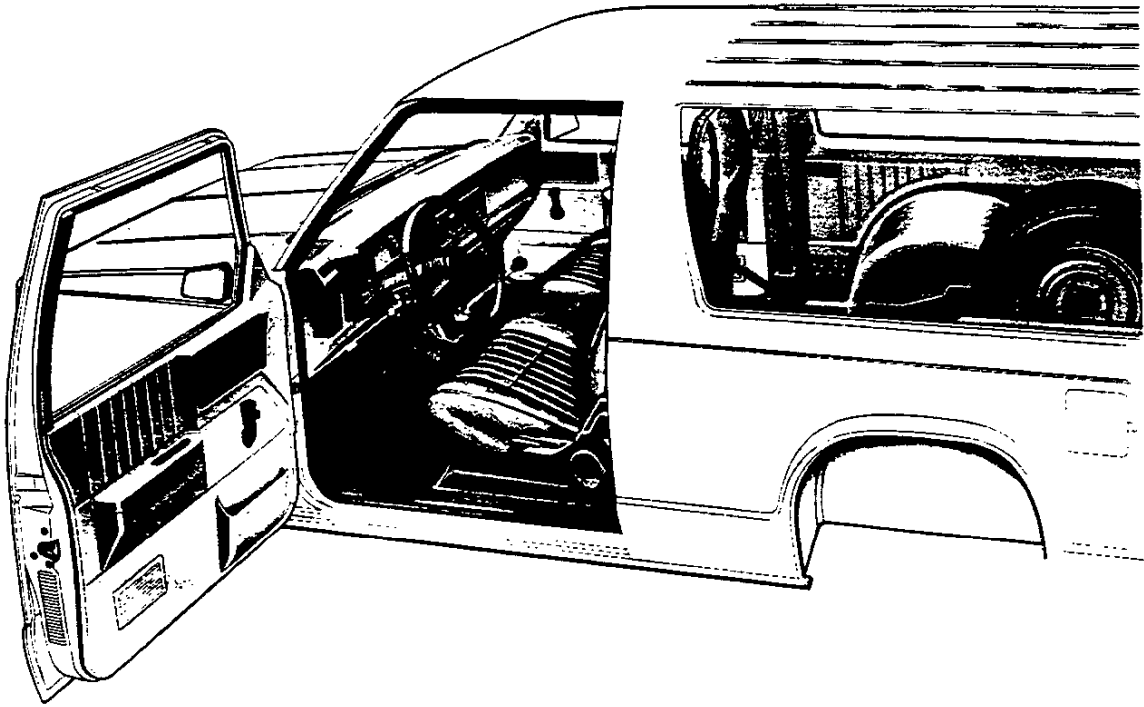

INTERIOR

- **Armrests:** RH and LH padded; integral with door trim panels
- **Ashtray:** In middle of instrument panel
- **Cigar Lighter:** With ashtray light
- **Coat Hook:** RH side
- **Colors:**
 - Painted areas: Same as exterior primary color choice
 - Interior trim: Coordinated with seat trim color choice
- **Dome Lamps:** Front and rear; with bright trim. Door-operated switches
- **Door Sill Plates:** Door-opening protection and floor mat retention; full-length; black plastic. Color-keyed plastic endgate scuff plate
- **Door Trim Panels:** Color-keyed, embossed molded plastic with integral armrests and map pockets; black housing in doorlatch
- **Floor Covering:** Color-keyed rubber mat for entire floor area
- **Grab Handle:** Over RH door (4x4 models only)
- **Headliner:** Color-keyed; full coverage molded styrene full foam with color-keyed cloth cover.
- **Headlamp Warning Buzzer**
- **Heater and Defogger:** Deluxe outside air type with power center and outboard instrument panel vents and side window defoggers
- **Hood Lock Release:** Handle located on LH side of instrument panel
- **Instrument Panel Trim:** Smooth low gloss black finish for instrument cluster bezel, and textured charcoal finished central area. Low gloss black light switch panel, heater/air conditioner control panel and RH/LH air conditioning outlet cover plates
- **Instruments:**
 - Gages: Speedometer, odometer and fuel
 - Switches: Main, for control of exterior lights, instrument cluster lights, and cab interior lights; combination steering column switch for direction signals by moving lever up and down, headlamp beams by moving lever fore and aft, and windshield wiper and washer by turning lever to wipe and pressing lever in to wash; hazard warning; heater fan; ignition with key-in warning buzzer
 - Warning lights: Generator, oil pressure, engine temperature, seat belt, service-parking brake, direction/hazard signal, and high beam
- **Instrument Panel Control Knobs:** Soft black plastic (except heater and wiper-washer controls) with white graphic identification
- **Instrument Panel Pad:** Color-keyed, energy-absorbing foam type with injection molded plastic substrate
- **Insulation and Sound Deadening Material:** On dash (fire-wall), under floor mat, spray deadener inside of doors, plugs on windshield pillars, on roof underside, and on headliner
- **Lights:** Instrument cluster, door-operated courtesy and dome lamps, and glove box lamp
- **Mirror, Rearview:** 10" prismatic with soft vinyl rim
- **Pillar Trim Moldings:** Color-keyed molded plastic on windshield pillars
- **Seats:** Driver and passenger, foam padded high back bucket type with leather grained custom vinyl trim. RH seat includes easy entry feature. See Interior and Exterior Color Selection Chart for color and trim availability
- **Seat Belts:** Driver and passenger non-detachable combination lap and shoulder belts with emergency-locking retractors. Seat belts are color-keyed with pushbutton type buckles
- **Spare Tire Mounting:** On LH side panel behind wheelhousing
Note: P205 and P235 full-size spare tire and wheel (available at extra cost) are stored flat at rear of body on floor.
- **Steering Wheel and Column:** 15¼" deluxe color-keyed soft plastic wheel with 2 spokes; deluxe color-keyed energy-absorbing steering column with anti-theft locking feature
- **Stowage Box:** In RH side of instrument panel; with bright key-operated lock and "S-10/S-15 Sierra" nameplate; lock operated by door key
- **Sunshades:** RH and LH padded; color-keyed
- **Tools:** Mechanical jack and wheel wrench behind rear seat on RH side
- **Tray:** Small package tray on lower right half of instrument panel

S-10/15 BLAZER/JIMMY 2- & 4-WHEEL DRIVE TAHOE/SIERRA CLASSIC MODEL OPTION—RPO YC2

This option includes all standard model items plus the additions or substitutions listed below

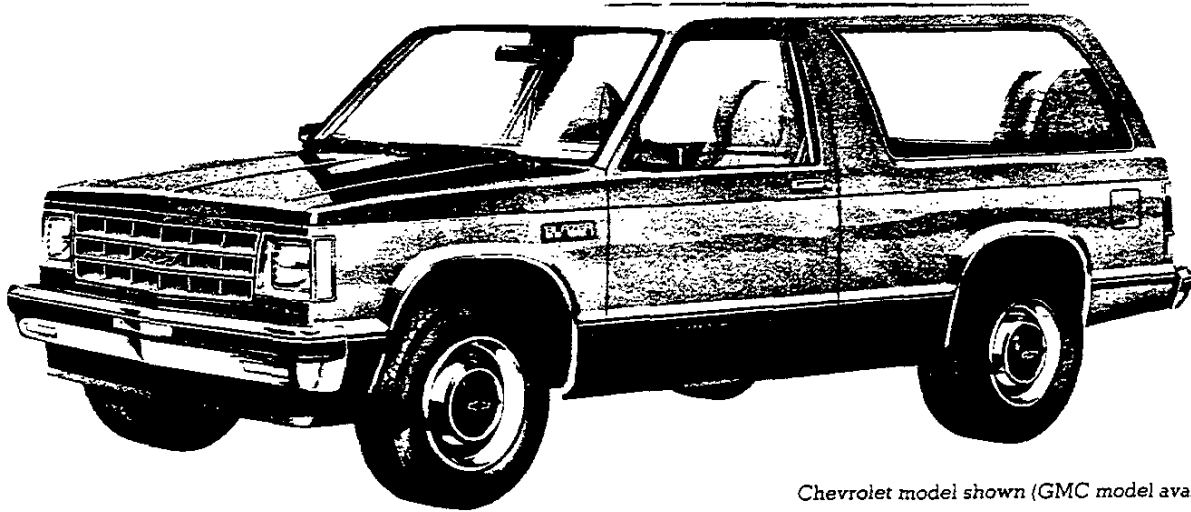

Chevrolet model shown (GMC model available)

EXTERIOR

- **Bright Appearance Items:**
Body side molding trim
Bright wheel opening lip moldings
Wheel trim rings
- **Cab-to-Fender Insulators**
- **Door Handle Inserts:** Body color
- **Hood Insulator**
- **Moldings:** Black plastic body side moldings with bright insert and rear quarter window moldings
- **Endgate Trim:** Black applique with bright "Chevrolet" and red "GMC" lettering and trim

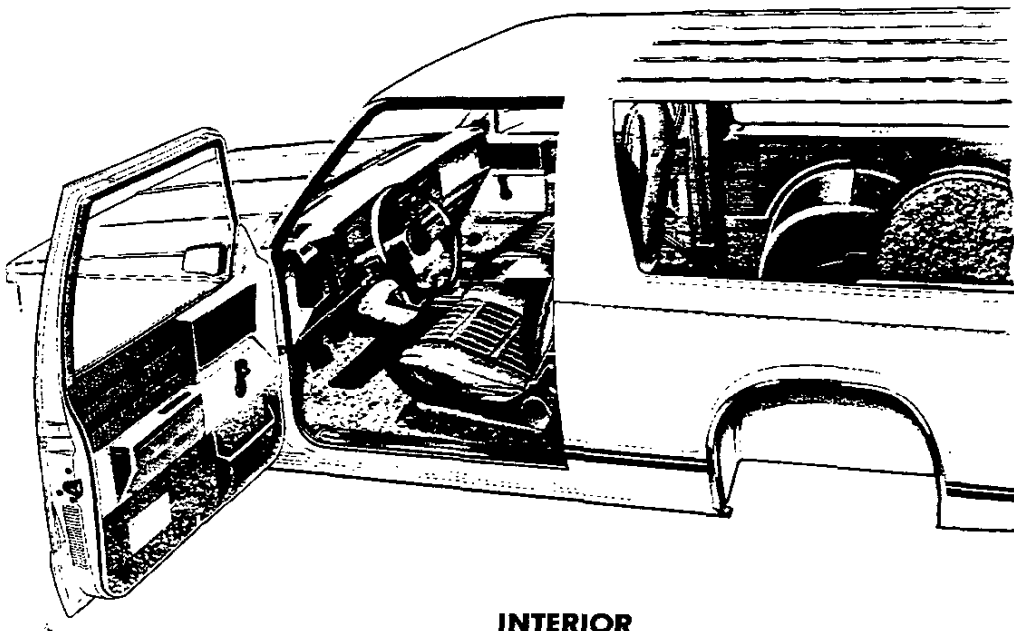

INTERIOR

- **Bright Appearance Items:**
"Tahoe/Sierra Classic" nameplate on stowage box door
- **Door Trim Panels:** Special custom cloth upper insert; carpeted lower insert with pocket, plus coin holder in LH door
- **Floor Covering:** Color-keyed carpeting for entire floor area (Color-keyed rubber mats are available, if desired)
- **Instrument Cluster:** Voltmeter, oil pressure gage and engine temperature gage replace warning lamps; also includes trip odometer
- **Insulation and Sound Deadening Material:** On plenum panels (part of specific dash mat), under floor carpeting, extra-thick on headliner, on door trim panels, and on lower portion of instrument panel
- **Seats:** Choice of: 1) leather grained custom vinyl trim; 2) dual-tone woven special custom cloth/vinyl trim. Also available at extra cost: genuine leather high back bucket seats. See Interior and Exterior Color Selection Chart for color and trim availability
- **Spare Tire Cover:** Color-keyed carpet and vinyl
- **Trim Panels and Moldings:** Color-keyed cowl kick panels; carpeted lower rear quarter and endgate panels
- **Visor Mirror:** On RH sun visor

S-10/15 BLAZER/JIMMY 2- & 4-WHEEL DRIVE

SPORT/GYPSY MODEL OPTION—RPO YC3

This option includes all items in the Tahoe/Sierra Classic model option plus the additions or substitutions listed below



Optional rear bumper shown in illustration
GMC model shown (Chevrolet model available)

EXTERIOR

- **Bright Appearance Items:**
Delete bright wheel opening lip moldings
- **Bumpers:** Color-keyed to lower accent color, with black rub strips
- **Door Handles:** Black chrome; also includes black chrome key cylinder covers
- **Grille:** Black chrome grille and headlamp bezels
- **Two-Tone Paint:** ZY7 lower-accent paint
- **Wheels:** 2-wheel drive—Rally wheel painted argent and black, with black ornamental hubs and bright trim rings; 4-wheel drive—base argent wheels with black ornamental hubs and bright trim rings
- **Wheel Opening Lip Moldings:** Black plastic

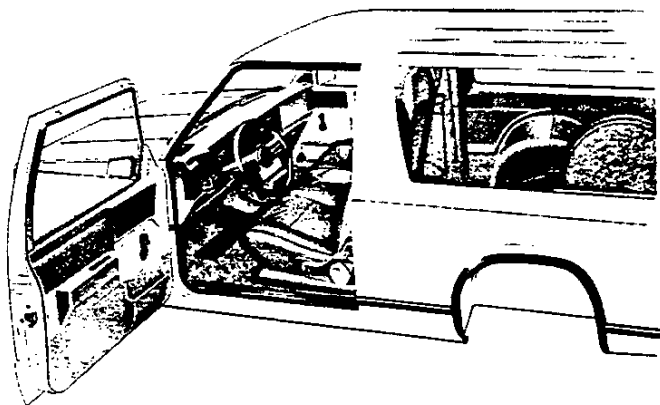

INTERIOR

- **Bright Appearance Items:**
"Sport/Gypsy" nameplate on stowage box door
- **Console:**
Color-keyed molded plastic with lockable stowage compartment; lock operated by door key
- **Seats:** High back, reclining buckets with deluxe cloth. Also available at extra cost: genuine leather trim. See Interior and Exterior Color Selection Chart for color and trim availability
- **Steering Wheel:** Sport wheel with simulated leather look
- **Trim Panel Inserts:** Deluxe cloth

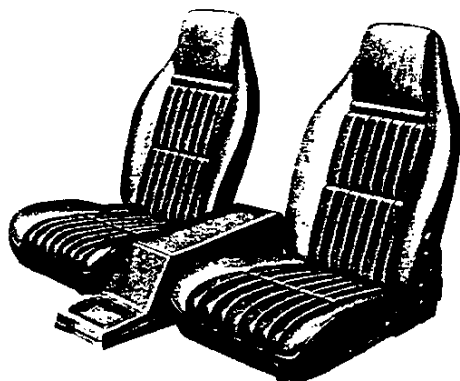

**STANDARD
FRONT BUCKET SEATS**
(Custom Vinyl Seat Trim Shown)

Consists of two high back bucket-type seats with foam padding and folding backrests with inertia latches. RH seat includes easy entry feature. A lockable color-keyed plastic center console with spacious stowage compartment is available. This console is included when the Sport/Gypsy Model Option is ordered. Reclining seat backs are available and are included with Sport/Gypsy Model Option.

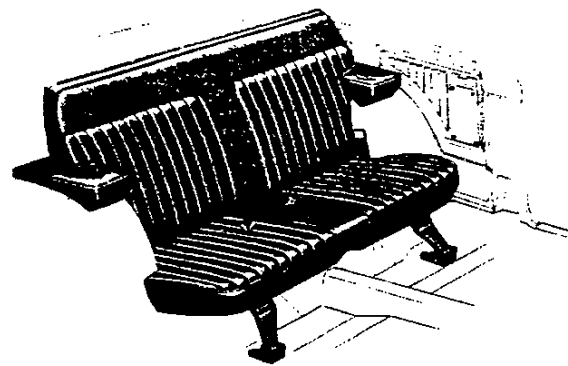

REAR FOLDING SEAT
(Custom Vinyl Seat Trim Shown)

This two-passenger seat is available on all models, and seat trim matches front seats when Custom Vinyl, Special Custom cloth or genuine leather is ordered. The seat cushion pivots forward and down and the seat back folds on to it to provide a flat floor over the entire load area. Armrests are included and attached to wheel housings. A zipper pocket is also included below armrests when Tahoe/Sierra Classic or Sport/Gypsy trim is ordered. Two seat belts included.

S-10/15 BLAZER/JIMMY 2- & 4-WHEEL DRIVE

DIMENSIONS*

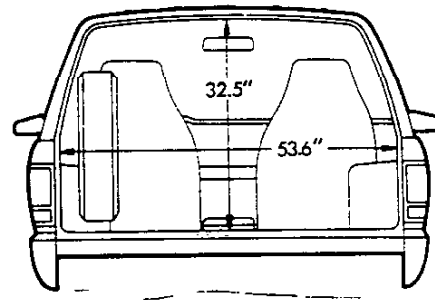
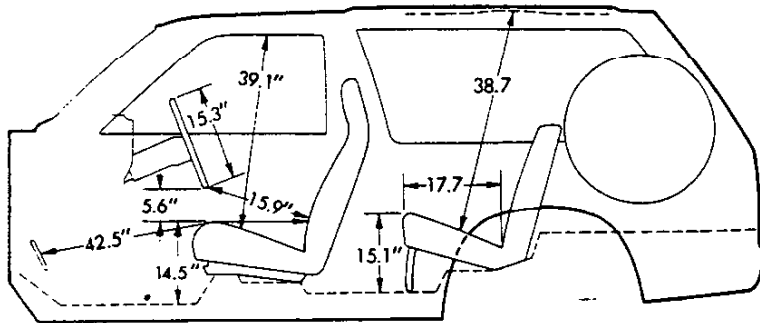

Glass Area (sq in)

Windshield	1138.5	Rear side windows (each side)	752.0
Front side door window (each side)	409.5	Rear window	757.0

**All interior dimensions measured with front seat in rearmost position. Seat travel is 5"*

INSTRUMENT CLUSTER

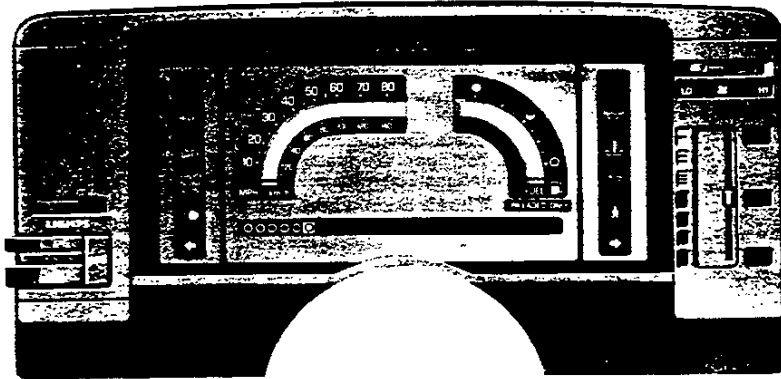

Standard Cluster with warning lights for engine temperature, generator, and oil pressure.

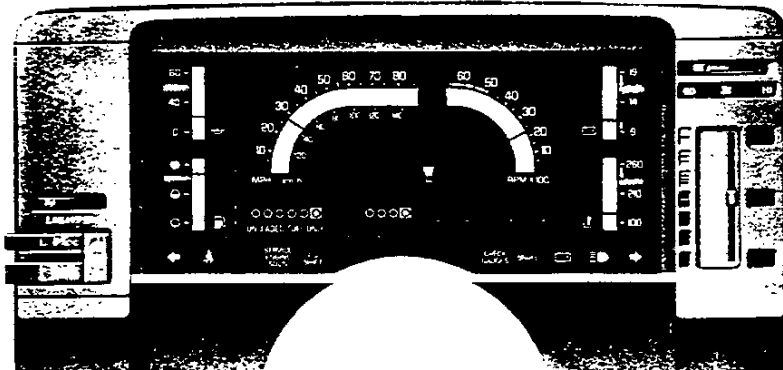

Optional Cluster (RPO Z53) with voltmeter, engine temperature gage, oil pressure gage and trip odometer. Included with tachometer (RPO U16) and in Tahoe/Sierra Classic model options (RPO YC2) and Sport/Gypsy model options (RPO YC3) along with bright brush-finished trim, as illustrated. Cluster faceplate for standard models has argent finish. When the optional tachometer is ordered, it replaces the regular fuel gage, and another fuel gage is added.

S-10/15 BLAZER/JIMMY 2- & 4-WHEEL DRIVE INTERIOR AND EXTERIOR COLOR AVAILABILITY CHART

Please Note: Below are the interior trim color and exterior paint combinations recommended by Chevrolet/GMC. The only available color code 1/color code 2 exterior color combinations are those shown in the chart below; however, any available interior trim color may be ordered with one of these exterior color combinations if that particular combination is desired by the customer.

WITH ZY1 PAINT - WITHOUT STRIPING

TRIM LEVEL Seat Type	Decor	INTERIOR COLORS			
		Blue	Carmine	Charcoal	Saddle Tan
STANDARD INTERIOR Custom Vinyl High Back Bucket Seats	Std	XDD4	XRR4	XJJ4	XSS4
TAHOE/SIERRA CLASSIC Custom Vinyl High Back Bucket Seats	YC2	XDD4	XRR4	XJJ4	XSS4
Special Custom Cloth High Back Bucket Seats		HDD4	HRR4	HJJ4	HSS4
High Country Sheepskin High Back Bucket Seats					*BSS4
Leather High Back Reclining Bucket Seats			AJU6	ASS6	

EXTERIOR COLORS w/ZY1 PAINT	Color Code 1	Color Code 2	RECOMMENDED INTERIOR TRIM COLORS			
BLACK, MIDNIGHT	19	19		X		
BLACK, MIDNIGHT	19	19			X	
BLACK, MIDNIGHT	19	19				X
BLUE, GALAXY (Metallic)	28	28	X		X	
BLUE, GALAXY (Metallic)	28	28				X
BLUE, LIGHT (Metallic)	21	21	X		X	
BRONZE, INDIAN (Metallic)	66	66			X	
BRONZE, INDIAN (Metallic)	66	66				X
EMERALD (Metallic)	44	44			X	
EMERALD (Metallic)	44	44				X
GOLD, NEVADA (Metallic)	67	67			X	X
GRAY, STEEL (Metallic)	90	90	X			
GRAY, STEEL (Metallic)	90	90		X		
GRAY, STEEL (Metallic)	90	90			X	
RED, APPLE	72	72		X		
RED, APPLE	72	72			X	
TAN, DOESKIN	61	61			X	
TAN, DOESKIN	61	61				X
WHITE, FROST	12	12	X			
WHITE, FROST	12	12		X		
WHITE, FROST	12	12			X	
WHITE, FROST	12	12				X

N/A-Not Available

*With YC2 Tahoe/Sierra Classic, rear seat trim is Special Custom Cloth

WITH D85 BODY STRIPING AND ZY1 PAINT

TRIM LEVEL Seat Type	Decor	INTERIOR COLORS				D85 STRIPING CHART RECOMMENDED COMBINATIONS Additional stripe combinations are available except where N/A is shown provided the dealer orders (D60) as verification (N/A B84 YC2 or YC3)							
		Blue	Carmine	Charcoal	Saddle Tan	STRIPE COLORS							
EXTERIOR COLORS w/ZY1 PAINT	Color Code 1	Color Code 2	RECOMMENDED INTERIOR TRIM COLORS				Black 19A	Blue, Dark 28A	Gold 67A	Gray 90A	Red 72A	Silver 17A	White 12A
STANDARD INTERIOR Custom Vinyl High Back Bucket Seats	Std		XDD4	XRR4	XJJ4	XSS4							
BLACK, MIDNIGHT	19	19		X			N/A	N/A					
BLACK, MIDNIGHT	19	19			X		N/A	N/A			X		
BLACK, MIDNIGHT	19	19				X	N/A	N/A	X				
BLUE, GALAXY (Metallic)	28	28	X		X		N/A	N/A			X		
BLUE, GALAXY (Metallic)	28	28				X	N/A	N/A	X	N/A			
BLUE, LIGHT (Metallic)	21	21	X		X				X	N/A	N/A		
BRONZE, INDIAN (Metallic)	66	66			X		N/A	N/A		N/A	N/A	X	
BRONZE, INDIAN (Metallic)	66	66				X	N/A	N/A	X	N/A	N/A		
EMERALD (Metallic)	44	44			X		N/A	N/A		N/A	N/A	X	
EMERALD (Metallic)	44	44				X	N/A	N/A	X	N/A	N/A		
GOLD, NEVADA (Metallic)	67	67			X	X	X	N/A	N/A	N/A	N/A		
GRAY, STEEL (Metallic)	90	90	X					X	N/A	N/A			
GRAY, STEEL (Metallic)	90	90		X					N/A	N/A			
GRAY, STEEL (Metallic)	90	90			X		X		N/A	N/A			
RED, APPLE	72	72		X					N/A	N/A			
RED, APPLE	72	72			X		X		N/A		X		
TAN, DOESKIN	61	61			X		X		N/A		N/A		
TAN, DOESKIN	61	61				X	X		N/A		N/A		
WHITE, FROST	12	12	X					X				N/A	
WHITE, FROST	12	12		X						X		N/A	
WHITE, FROST	12	12			X				X			N/A	
WHITE, FROST	12	12				X		X				N/A	

N/A-Not Available

*With YC2 Tahoe/Sierra Classic, rear seat trim is Special Custom Cloth

S-10/15 BLAZER/JIMMY 2- & 4-WHEEL DRIVE

INTERIOR AND EXTERIOR COLOR AVAILABILITY CHART

WITH BODY STRIPING AND ZY6, ZY7 or ZY8 PAINT

Please Note: Below are the interior trim color and exterior paint combinations recommended by Chevrolet/GMC. The only available color code 1/color code 2 exterior color combinations are those shown in the chart below; however, any available interior trim color may be ordered with one of these exterior color combinations if that particular combination is desired by the customer.

TRIM LEVEL Seat Type	INTERIOR COLORS				
	Decor	Blue	Carmine	Charcoal	Saddle Tan
STANDARD INTERIOR Custom Vinyl High Back Bucket Seats	Std.	XDD4	XRR4	XJJ4	XSS4
TAHOE/SIERRA CLASSIC Custom Vinyl High Back Bucket Seats	YC2	XDD4	XRR4	XJJ4	XSS4
Special Custom Cloth High Back Bucket Seats		HDD4	HRR4	HJJ4	HSS4
High Country Sheepskin High Back Bucket Seats					*BSS4
Leather High Back Reclining Bucket Seats				AJJ6	ASS6
SPORT/GYPSY (Reqs. ZY6 or ZY7 Paint) Deluxe Cloth High Back Bucket Seats	YC3			DJJ4	DSS4
High Country Sheepskin High Back Bucket Seats					*BSS4
Leather High Back Reclining Bucket Seats				AJJ6	ASS6

EXTERIOR COLORS w/ZY6, ZY7 or ZY8 PAINT	Color Code 1	Color Code 2	RECOMMENDED INTERIOR TRIM COLORS	STRIPED COLORS—ZY7 ONLY (Stripe Colors Cannot be Changed) (N/A ZY8) (With ZY6 Paint Refer to Page 6 for Striping Chart)					
				Black	Blue, Dark	Gold	Red	Silver	White
BLACK, MIDNIGHT									
Gold, Nevada (Metallic)	19	67				X			
Red, Apple	19	72		X	X			X	
Silver (Metallic)	19	17		X	X				X
White, Frost	19	12		X	X				X
BLUE, GALAXY (Metallic)									
Gold, Nevada (Metallic)	28	67	X			X		X	
Silver (Metallic)	28	17	X				X		
White, Frost	28	12	X						X
BLUE, LIGHT (Metallic)									
Black, Midnight	21	19	X		X		X		
Blue, Galaxy (Metallic)	21	28	X				X		
Silver (Metallic)	21	17	X		X				X
White, Frost	21	12	X						X
BRONZE, INDIAN (Metallic)									
Gold, Nevada (Metallic)	66	67				X		X	
Silver (Metallic)	66	17			X				X
White, Frost	66	12			X				X
EMERALD (Metallic)									
Gold, Nevada (Metallic)	44	67				X		X	
White, Frost	44	12			X	X			X
GOLD, NEVADA (Metallic)									
Black, Midnight	67	19			X	X	X		
White, Frost	67	12			X	X			X
GRAY, STEEL (Metallic)									
Black, Midnight	90	19		X	X		X		
Blue, Galaxy (Metallic)	90	28	X		X			X	
Red, Apple	90	72		X	X				X
Silver (Metallic)	90	17	X	X	X				X
White, Frost	90	12	X		X				X
RED, APPLE									
Black, Midnight	72	19		X	X		X		
Silver (Metallic)	72	17		X	X				X
White, Frost	72	12		X	X				X
TAN, DOESKIN									
Black, Midnight	61	19			X		X		
Blue, Galaxy (Metallic)	61	28	X					X	
Red, Apple	61	72		X					X
White, Frost	61	12			X				X
WHITE, FROST									
Black, Midnight	12	19		X	X		X		
Blue, Galaxy (Metallic)	12	28	X					X	
Gold, Nevada (Metallic)	12	67			X	X		X	
Red, Apple	12	72		X	X				X
Silver (Metallic)	12	17	X	X	X				X

*With YC2 Tahoe/Sierra Classic, rear seat trim is Special Custom Cloth, with YC3 Sport/Gypsy, rear seat trim is Deluxe Cloth.

S-10/15 BLAZER/JIMMY 2- & 4-WHEEL DRIVE

INTERIOR AND EXTERIOR COLOR AVAILABILITY CHART

WITH D90 SUNSHINE STRIPING

Please Note: Below are the interior trim color and exterior paint combinations recommended by Chevrolet/GMC. The only available color code 1/color code 2 exterior color combinations are those shown in the chart below; however, any available interior trim color may be ordered with one of these exterior color combinations if that particular combination is desired by the customer.

TRIM LEVEL Seat Type	Decor	INTERIOR COLORS			
		Blue	Carmine	Charcoal	Saddle Tan
STANDARD INTERIOR Custom Vinyl High Back Bucket Seats	Std.	XDD4	XRR4	XJJ4	XSS4
TAHOE/SIERRA CLASSIC Custom Vinyl High Back Bucket Seats	YC2	XDD4	XRR4	XJJ4	XSS4
Special Custom Cloth High Back Bucket Seats		HDD4	HRR4	HJJ4	HSS4
High Country Sheepskin High Back Bucket Seats					BSS4
Leather High Back Reclining Bucket Seats				AJJ6	ASS6
SPORT/GYPSY (Reqs ZY6 or ZY7 Paint) Deluxe Cloth High Back Bucket Seats	YC3			DJJ4	DSS4
High Country Sheepskin High Back Bucket Seats					BSS4
Leather High Back Reclining Bucket Seats				AJJ6	ASS6

EXTERIOR COLORS w/ZY1 PAINT	Color Code 1	Color Code 2	RECOMMENDED INTERIOR TRIM COLORS				STRIPE COLORS				
			Blue	Carmine	Charcoal	Saddle Tan	Black 19A	Gold 67A	Silver 17A	White 12A	Gray 90A
BLACK, MIDNIGHT	19	19	N/A	N/A	X	N/A	N/A	X	X	X	X
BLACK, MIDNIGHT	19	19		X	N/A	N/A	N/A	N/A	X	X	X
BLACK, MIDNIGHT	19	19	N/A	N/A	N/A	X	N/A	X	N/A	X	N/A
BLUE, GALAXY (Metallic)	28	28	X		X	X	N/A	N/A	X	X	N/A
BLUE, LIGHT (Metallic)	21	21	X		X		X	N/A	N/A	X	N/A
BRONZE, INDIAN (Metallic)	66	66			X	N/A	N/A	X	X	X	N/A
BRONZE, INDIAN (Metallic)	66	66	N/A	N/A	N/A	X	N/A	X	N/A	X	N/A
EMERALD (Metallic)	44	44			X	X	N/A	X	N/A	N/A	N/A
GOLD, NEVADA (Metallic)	67	67			X	X	X	N/A	N/A	N/A	N/A
GRAY, STEEL (Metallic)	90	90	X	X	X		X	N/A	N/A	N/A	N/A
RED, APPLE	72	72		X	X		X	N/A	N/A	X	N/A
TAN, DOESKIN	61	61			X	X	X	N/A	N/A	X	X
WHITE, FROST	12	12	X	X	X	N/A	X	N/A	X	N/A	X
WHITE, FROST	12	12	N/A	N/A	N/A	X	X	N/A	N/A	N/A	N/A

w/ZY6 PAINT	STRIPE COLORS (Stripe colors cannot be changed)			
	Black	Gold	Gray	White
BLACK, MIDNIGHT				
Gold, Nevada (Metallic)	19	67	N/A	N/A
Silver (Metallic)	19	17	N/A	X
Red, Apple	19	72	N/A	X
White, Frost	19	12	N/A	X
GOLD, NEVADA (Metallic)				
Black, Midnight	67	19	N/A	N/A
GRAY, STEEL (Metallic)				
Black, Midnight	90	19		X
Blue, Galaxy (Metallic)	90	28	X	N/A
Red, Apple	90	72	N/A	X
Silver (Metallic)	90	17	X	X
White, Frost	90	12	X	X
WHITE, FROST				
Black, Midnight	12	19	N/A	X
Blue, Galaxy (Metallic)	12	28	X	N/A
Gold, Nevada (Metallic)	12	67		X
Silver (Metallic)	12	17	X	N/A
Red, Apple	12	72	N/A	X

N/A-Not Available

S-10/15 BLAZER/JIMMY 2- & 4-WHEEL DRIVE

INTERIOR AND EXTERIOR COLOR AVAILABILITY CHART

WITH D98 RALLY STRIPING

Please Note: Below are the interior trim color and exterior paint combinations recommended by Chevrolet/GMC. The only available color code 1/color code 2 exterior color combinations are those shown in the chart below; however, any available interior trim color may be ordered with one of these exterior color combinations if that particular combination is desired by the customer.

TRIM LEVEL Seat Type	Decor	INTERIOR COLORS			
		Blue	Carmine	Charcoal	Saddle Tan
STANDARD INTERIOR Custom Vinyl High Back Bucket Seats	Std.	XDD4	XRR4	XJJ4	XSS4
TAHOE/SIERRA CLASSIC Custom Vinyl High Back Bucket Seats	YC2	XDD4	XRR4	XJJ4	XSS4
Special Custom Cloth High Back Bucket Seats		HDD4	HRR4	HJJ4	HSS4
High Country Sheepskin High Back Bucket Seats					BSS4
Leather High Back Reclining Bucket Seats				AJJ6	ASS6

EXTERIOR COLORS w/ZY1 PAINT	Color Code 1	Color Code 2	RECOMMENDED INTERIOR TRIM COLORS				STRIPE COLORS						
			Blue	Carmine	Charcoal	Saddle Tan	Black 19A	Dk. Blue 28A	Gold 67A	Red 72A	Silver 17A	White 12A	
BLACK, MIDNIGHT	19	19			X		N/A	N/A				X	
BLACK, MIDNIGHT	19	19				X	N/A	N/A	X				
BLACK, MIDNIGHT	19	19		X			N/A	N/A		X			
BLUE, GALAXY (Metallic)	28	28	X		X		N/A	N/A		N/A	X		
BLUE, GALAXY (Metallic)	28	28				X	N/A	N/A	X	N/A			
BLUE, LIGHT (Metallic)	21	21	X		X			X	N/A	N/A			
BRONZE, INDIAN (Metallic)	66	66			X		N/A	N/A	X	N/A			
BRONZE, INDIAN (Metallic)	66	66				X	N/A	N/A	X	N/A	N/A	N/A	
EMERALD (Metallic)	44	44			X	X	N/A	N/A	X	N/A	N/A	N/A	N/A
GOLD, NEVADA (Metallic)	67	67			X	X	X	N/A	N/A	N/A	N/A	N/A	
GRAY, STEEL (Metallic)	90	90			X		X		N/A	N/A		N/A	
GRAY, STEEL (Metallic)	90	90	X					X	N/A			N/A	
GRAY, STEEL (Metallic)	90	90		X					N/A	X		N/A	
RED, APPLE	72	72			X		X	N/A		N/A			
RED, APPLE	72	72		X				N/A		N/A	X		
TAN, DOESKIN	61	61			X		X	N/A	N/A	N/A	N/A	N/A	N/A
TAN, DOESKIN	61	61				X	N/A	N/A	N/A	N/A	N/A	N/A	X
WHITE, FROST	12	12			X		X						N/A
WHITE, FROST	12	12	X					X					N/A
WHITE, FROST	12	12				X			X				N/A
WHITE, FROST	12	12		X						X			N/A

N/A-Not Available

S-10/15 BLAZER/JIMMY 2- & 4-WHEEL DRIVE

STRIPING CHART FOR ZY6 CUSTOM TWO-TONE

INTERIOR TRIM COLOR			BLUE	CARMINE	CHARCOAL	SADDLE TAN
EXTERIOR PAINT COLOR	Color Code 1	Color Code 2	STRIPE COLORS			
BLACK, MIDNIGHT/Gold, Nevada (Met)	19	67	*Orange/Yellow	*Orange/Yellow	Orange/Yellow	Orange/Yellow
BLACK, MIDNIGHT/Red, Apple	19	72	*Silver	Silver	Silver	*Silver
BLACK, MIDNIGHT/Silver (Met)	19	17	*Blue	Blue	Blue	*Red
BLACK, MIDNIGHT/White, Frost	19	12	*Blue	Red	Red	*Gold
BLUE, GALAXY (MET)/Gold, Nevada (Met)	28	67	Orange/Yellow	*Orange/Yellow	*Orange/Yellow	Orange/Yellow
BLUE, GALAXY (MET)/Silver (Met)	28	17	Blue	*Red	*Blue	*Blue
BLUE, GALAXY (MET)/White, Frost	28	12	Blue	*Red	*Blue	*Blue
BLUE, LIGHT (MET)/Black, Midnight	21	19	Blue	*Blue	Blue	*Blue
BLUE, LIGHT (MET)/Blue, Galaxy (Met)	21	28	Blue	*Silver	*Silver	*Blue
BLUE, LIGHT (MET)/Silver (Met)	21	17	Blue	*Blue	Blue	*Blue
BLUE, LIGHT (MET)/White, Frost	21	12	Blue	*Red	*Blue	*Blue
BRONZE, INDIAN (MET)/Gold, Nevada (Met)	66	67	*Orange/Yellow	*Orange/Yellow	*Orange/Yellow	Orange/Yellow
BRONZE, INDIAN (MET)/Silver (Met)	66	17	*Orange/Yellow	*Orange/Yellow	Orange/Yellow	*Orange/Yellow
BRONZE, INDIAN (MET)/White, Frost	66	12	*Orange/Yellow	*Orange/Yellow	*Orange/Yellow	Orange/Yellow
EMERALD (MET)/Gold, Nevada (Met)	44	67	*Gold	*Gold	*Gold	Gold
EMERALD (MET)/White, Frost	44	12	*Gold	*Gold	Gold	Gold
GOLD, NEVADA (MET)/Black, Midnight	67	19	*Gold	*Gold	*Gold	Gold
GOLD, NEVADA (MET)/White, Frost	67	12	*Orange/Yellow	*Gold	Orange/Yellow	Gold
GRAY, STEEL (MET)/Black, Midnight	90	19	*Blue	Red	Red	*Silver
GRAY, STEEL (MET)/Blue, Galaxy (Met)	90	28	Blue	*Silver	Silver	*Silver
GRAY, STEEL (MET)/Red, Apple	90	72	*Silver	Silver	Silver	*Silver
GRAY, STEEL (MET)/Silver (Met)	90	17	Blue	Red	Red	*Red
GRAY, STEEL (MET)/White, Frost	90	12	Blue	*Red	Blue	Blue
RED, APPLE/Black, Midnight	72	19	*Silver	Red	Silver	*Red
RED, APPLE/Silver (Met)	72	17	*Red	Red	Red	*Red
RED, APPLE/White, Frost	72	12	*Silver	Silver	*Silver	*Gold
TAN, DOESKIN/Black, Midnight	61	19	*Orange/Yellow	*Orange/Yellow	Orange/Yellow	*Orange/Yellow
TAN, DOESKIN/Blue, Galaxy (Met)	61	28	Blue	*Blue	*Blue	*Blue
TAN, DOESKIN/Red, Apple	61	72	*Red	Red	*Red	*Red
TAN, DOESKIN/White, Frost	61	12	*Red	*Red	Red	*Red
WHITE, FROST/Black, Midnight	12	19	*Blue	Red	Red	*Gold
WHITE, FROST/Blue, Galaxy (Met)	12	28	Blue	*Blue	*Blue	*Blue
WHITE, FROST/Gold, Nevada (Met)	12	67	*Orange/Yellow	*Orange/Yellow	Orange/Yellow	Orange/Yellow
WHITE, FROST/Red, Apple	12	72	*Silver	Silver	Silver	*Gold
WHITE, FROST/Silver (Met)	12	17	Blue	Red	Red	*Red

*Stripe color/trim color combination available but not recommended.

S-10/15 BLAZER/JIMMY 2- & 4-WHEEL DRIVE

SOLID AND TWO-TONE* EXTERIOR COLOR COMBINATIONS

The application of paint for solid and two-tone exterior color combinations is shown below.

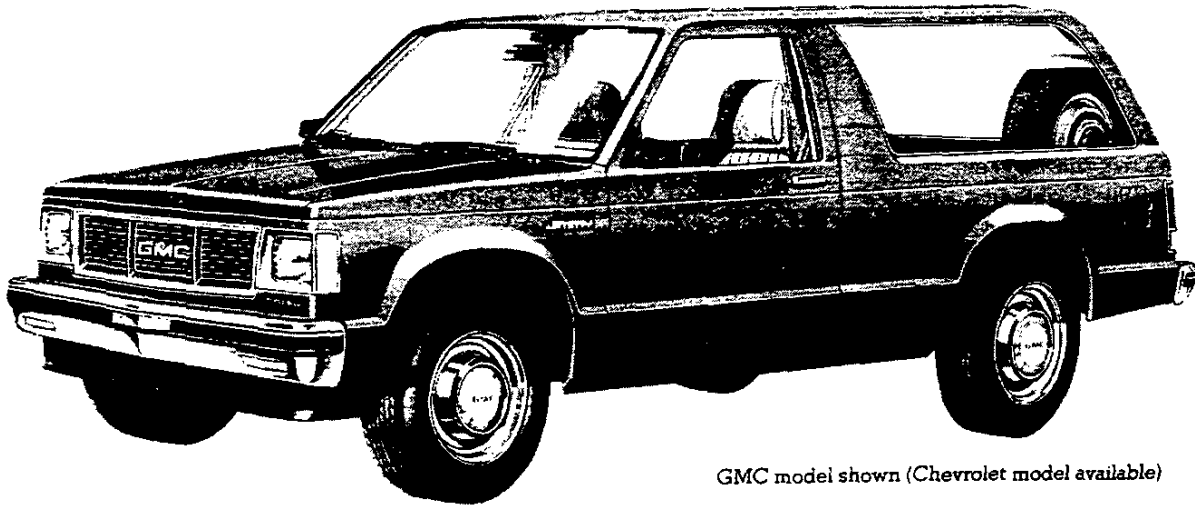

GMC model shown (Chevrolet model available)

SOLID COLOR

Solid paint (ZY1) is standard on all models (except Sport/Gypsy). All painted areas of the body and front end sheet metal are the same color. Tailgate lettering for base models is

silver when Galaxy Blue, Indian Bronze, Midnight Black, or Apple Red exterior colors are specified and black for all other exterior colors.

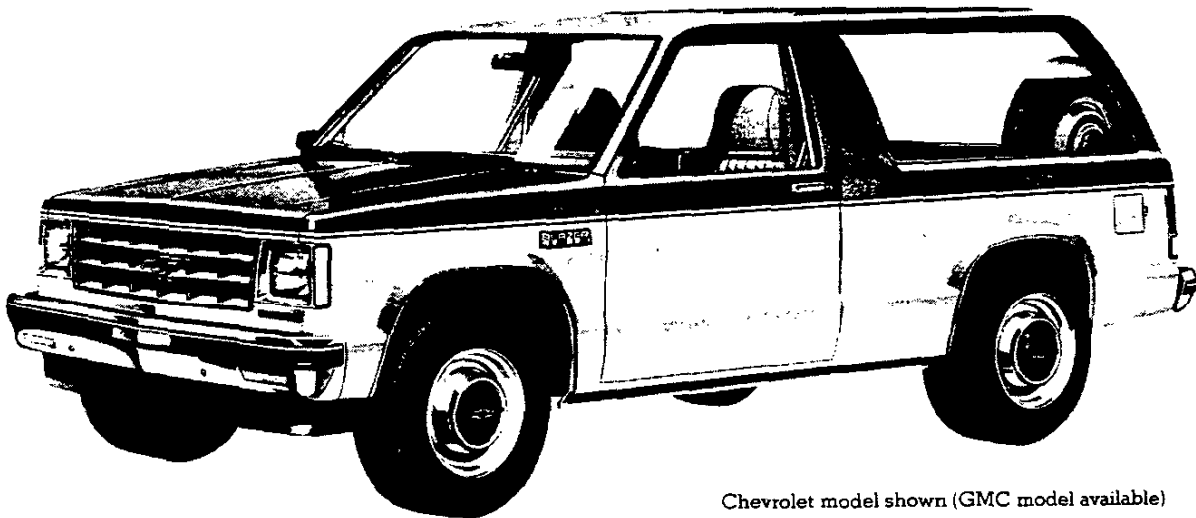

Chevrolet model shown (GMC model available)

CUSTOM TWO-TONE

Custom two-tone paint (ZY6) is available on all models. The areas above the belt styling crease line are painted the color code 1 paint color. The areas below that line are painted the color code 2 color. A color-keyed decal stripe is applied at the belt styling crease line just below the paint

break (See color stripe chart on page 1). Tailgate lettering for base models is silver when Galaxy Blue, Indian Bronze, Midnight Black, or Apple Red color code 2 exterior colors are specified and black for all other colors.

*Optional at extra cost

S-10/15 BLAZER/JIMMY 2- & 4-WHEEL DRIVE

SOLID AND TWO-TONE* EXTERIOR COLOR COMBINATIONS

The application of paint for solid and two-tone exterior color combinations is shown below.

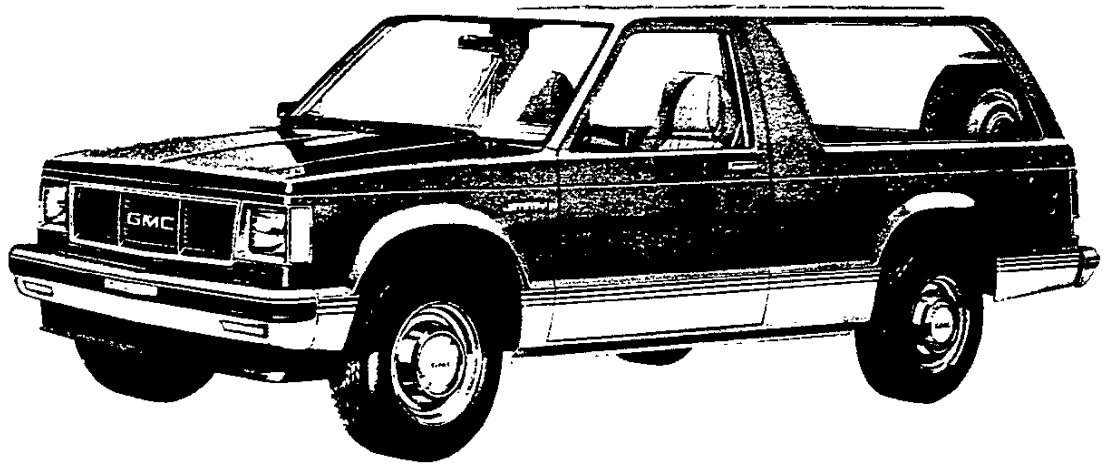

SPORT TWO-TONE

Sport two-tone paint (ZY7), which provides a lower accent two-tone scheme, is available on base and Tahoe/Sierra Classic models, and is included when the Sport/Gypsy Model Option (YC3) is ordered. A wide, four stripe decal is included on base models, and is applied below the lower styling crease lines. The decal color matches the color code 2 paint choice, and is applied over the paint break line in such a way that the color code 1 color paint shows through the clear areas to contrast with the decal colors. The

color code 1 color choice is applied to the areas above the bottom stripe of the decal, and the color code 2 color is applied to the areas below the decal. RPO B84 Body Side Moldings may be ordered with ZY7 on base models, if desired (at extra cost), and will replace the striping decal. Tailgate lettering for base models is silver when Galaxy Blue, Indian Bronze, Midnight Black, or Apple Red exterior colors are specified and black for all other exterior colors.

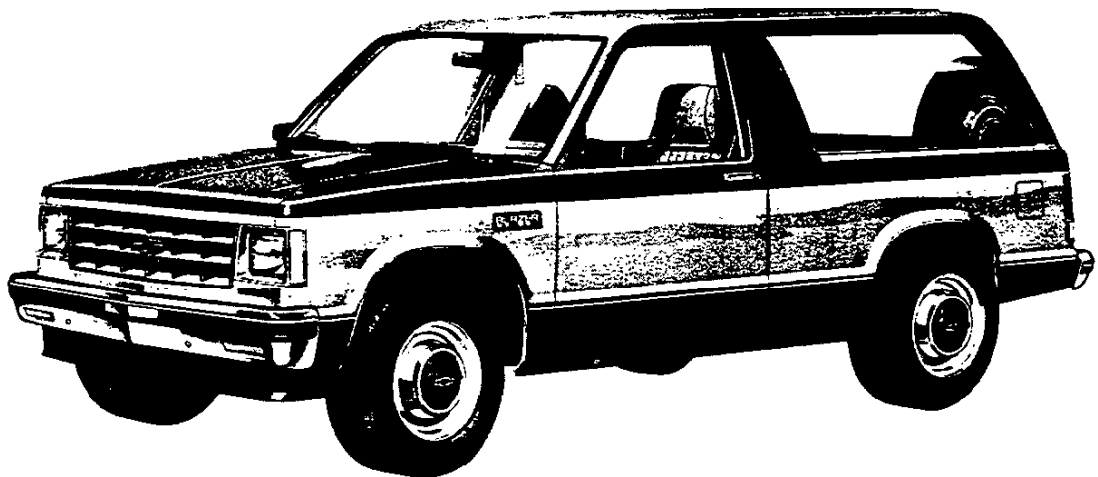

SPECIAL TWO-TONE

Special two-tone paint (ZY8), which provides a mid-accent two-tone scheme, is available on base and Tahoe/Sierra Classic models and includes B84 body side and wheel opening moldings (except on Tahoe/Sierra Classic models where already included) which are applied below the lower styling crease lines. The areas below the molding and above

the belt styling crease line are painted the color code 1 paint color. The areas between the molding and the belt styling crease line are painted the color code 2 color. Tailgate lettering for base models is silver when Galaxy Blue, Indian Bronze, Midnight Black, or Apple Red color code 2 exterior colors are specified and black for all other colors.

*Optional at extra cost

S-10/15 BLAZER/JIMMY 2- & 4-WHEEL DRIVE

SOLID AND TWO-TONE* EXTERIOR COLOR COMBINATIONS

The application of paint for solid and two-tone exterior color combinations is shown below.



Chevrolet model shown (GMC model available)

RALLY STRIPING

RPO D98 Rally Striping is available in six colors and is available on S-10/15 Blazer/Jimmy models only when ZY1 Solid Paint is ordered. A decal stripe color must be selected from the D98 color selection chart on page H. The 6 stripe decal is applied just above the belt styling crease line

on the front fenders, door and body sides. The stripes vary in width from about $\frac{1}{2}$ " at the bottom to $\frac{1}{4}$ " at the top, with an overall width of about 3." Clear areas between the stripes allow the exterior paint color to show through.

*Optional at extra cost

S-10/15 BLAZER/JIMMY 2- & 4-WHEEL DRIVE

SOLID AND TWO-TONE* EXTERIOR COLOR COMBINATIONS

The application of paint for solid and two-tone exterior color combinations is shown below.

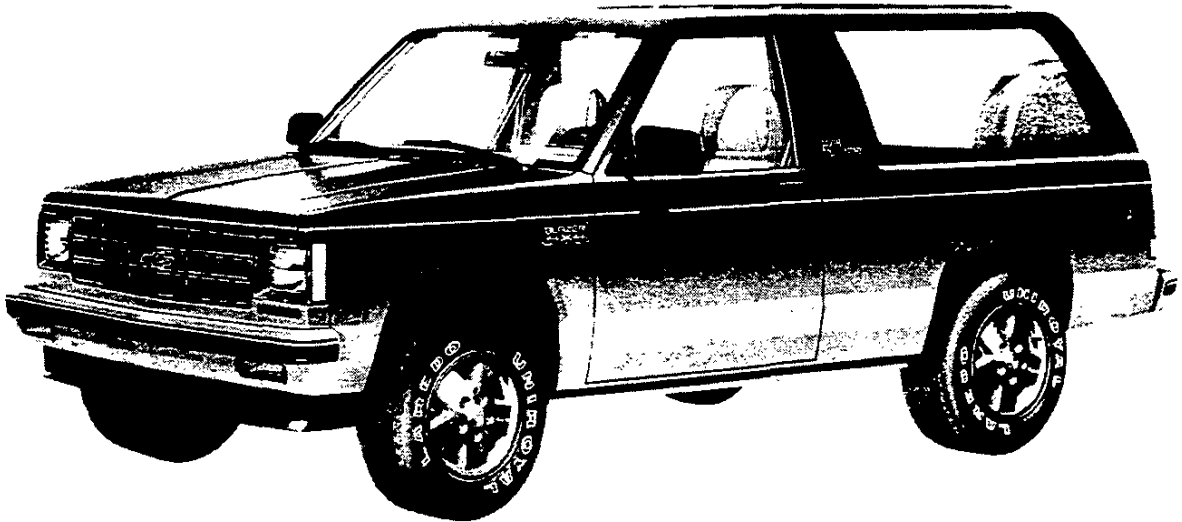

HIGH COUNTRY/TIMBERLINE PACKAGE

The High Country/Timberline Package is available only when the YC2 Tahoe/Sierra Classic model option or YC3 Sport/Gypsy model and ZY6 Custom Two-Tone Paint is ordered on 4x4 Blazer/Jimmy models. Color Code 1 must be Midnight Black and Color Code 2 must be Nevada Gold Metallic. A wide decal is applied across the center of the vehicle and is graduated in color from Black at the top to Gold at the bottom. The decal extends from the belt styling crease line to the lower styling crease line.

The High Country/Timberline Package includes special decal nameplates; black chrome on grille, headlamp trim, taillamp trim, door handles, and nameplates; reclining seat backs and deep tinted glass (with light tinted rear window), black below eyeline mirrors, console (on YC2 models only), color-keyed bumpers and special gold tone aluminum wheels. The package requires white lettered tires, full size spare tire and saddle tan interior trim with either custom cloth or genuine leather seat trim.



*Optional at extra cost

NOTES

S-10/15 BLAZER/JIMMY 2- & 4-WHEEL DRIVE

MODEL SELECTOR

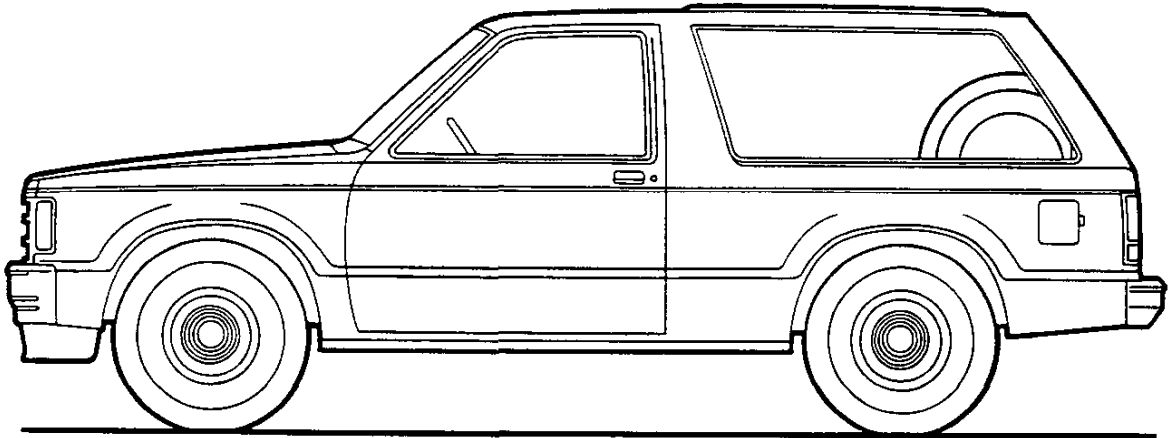

SERIES	MODEL NUMBER	BODY ORDERING CODE
S-10/S-15 (4x2)	S10516	E55
S-10/S-15 (4x4)	T10516	E55

S-10/15 BLAZER/JIMMY 2- & 4-WHEEL DRIVE

STANDARD SPECIFICATIONS

(See Gray Tab Section for Specification Details)

Series	S-10/15 4x2	S-10/15 4x4
Engine	2.5 Liter (151 Cu. In.) EFI L4	
Base Equip.	9.13; 71.86 sq. in.	
Clutch	Oiled-paper Element	
Air Filter	Throwaway Type	
Oil Filter	Single Aluminized	
Exhaust System	Meets Government Requirements	
Emission Control Systems		
Suspension, Front	Independent	Independent Driving Axle
Type	Coil Springs	Torsion Bar
Axle Capacity	2200 lb.	2400 lb.
Axle Ratio	—	3.73
Springs @ Ground	1100 lb. ea.	1200 lb. ea.
Shock Absorbers (Low-pressure Gas)	25mm dia.	25mm dia.
Stabilizer Bar	29mm dia.	32mm dia.
Suspension, Rear	Salisbury Axle; Hypoid Drive; Two-stage Multi-leaf Springs	
Type	Leaf Springs	
Axle Capacity	2600 lb.	2700 lb.
Axle Ratio	3.73	
Springs, Main @ Ground	1350 lb. ea.	
Shock Absorbers (Low-pressure Gas)	25mm dia.	
Brakes	Hydraulic; Self-adjusting	
Front	Disc; 10.51" Rotor	
Rear	Drum; 9.49" x 2"	
Booster	Single Diaphragm	
Parking	Cable to Rear Wheels	
Electrical	12 Volt; Negative Ground	
Battery—Freedom Type	525 CCA ♦ @ 0°F.	
— Reserve Capacity	90 min. @ 80°F.	
Delcotron Generator	85 amp.	
Frame	Carbon Steel; 36,39,000 psi	
Section Modulus	1.78	
Fuel Tank (nominal capacity)	13.2 gal.	
Steering Gear Type	Manual; Recirculating Ball Gear	
Linkage	Parallelogram	
Transmission	4-Speed Manual	
Shift Location	Floor	
Transfer Case	—	New Process 207 2-Speed
Shift Lever	—	Single Lever
Tires	(4) P195/75R15 All Seasons Steel Belted Radial	
Spare	(1) T155/90D16	
Wheels	(4) Disc, 15" x 6"	
Spare	(1) Disc, 16" x 4"	

♦ CCA-Cold Cranking Amps

S-10/15 BLAZER/JIMMY 2- & 4-WHEEL DRIVE

Body Ordering Code: E55

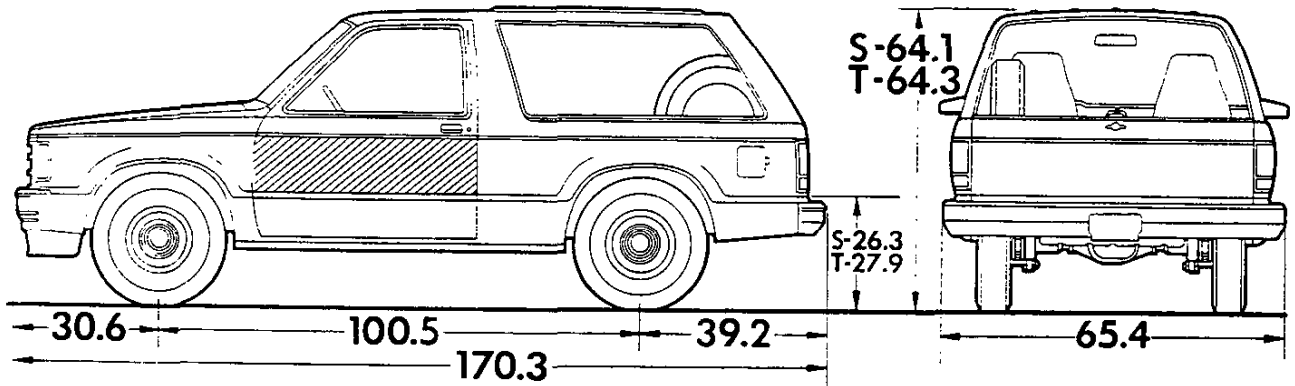

Sign Panel Area (side)
12 3/4" x 45"

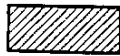

Capacity (Cu. Ft.)
Std - 67.3
w/rear seat - 28.1

Model	Body Ordering Code	Engine No. Cyl.	Curb Weight (lb)			Model Weights (lb)*			Ground Clearance (in)*
			Front	Rear	Total	Front	Rear	Total	Minimum
S10516	E55	4	1458	1422	2880	1597	1583	3180	7.4
T10516	E55	4	1662	1478	3140	1801	1639	3440	6.6

* Dimensions with standard equipment, unloaded.

*Model Weights include curb weight plus occupants (standard seating capacity x 150 lbs.). Total Weight may vary as much as ±50 lbs. to allow for production build variation.

PAYLOAD SELECTOR

‡Maximum Ratings				Minimum Equipment Required for GVW Rating		
Payload (lb)	GVW Range (lb)	†GAWR (lb)		Tires, Front	Tires, Rear	Chassis Equipment
		Front	Rear			
S-10/S-15 MODELS (2-WHEEL DRIVE)						
1000	3894 to 4549	2200	2600	P195/75R15	P195/75R15	Standard
S-10/S-15 MODELS (4-WHEEL DRIVE)						
1000	4149 to 4872	2400	2684	P195/75R15	P195/75R15	Standard

‡GAWRs shown are the maximum for each axle with the equipment listed. Maximum ratings include an additional 50 lbs. allowance for vehicle weight variance.

†GAWR - Gross Axle Weight Rating.

S-10/15 BLAZER/JIMMY 2- & 4-WHEEL DRIVE

POWER TEAMS

Note: All payloads for S Blazer/Jimmy are 1000 lbs

ALL STATES EXCEPT CALIFORNIA

POWER TEAMS (MUST ORDER ENGINE, TRANSMISSION AND REAR AXLE)

ENGINE	TRANSMISSION			AXLE			
	4-SP	5-SP	AUTO	3.08	3.42	3.73	4.11
W/NA5 STANDARD EMISSION EQUIPMENT							
—S10516							
LN8 L4 2.5 Liter EFI	MM4		MX0	—	—	GQ1	H04
		MM5		—	—	—	GQ1
LL2 V6 2.8 Liter EFI (Reqs N40 Steering)	MM4			GQ1	GU6	—	—
		MM5		—	GQ1	GT4	—
			MX0	—	GQ1	GT4	—
—T10516							
LN8 L4 2.5 Liter EFI	MM4			—	—	*GQ1	\$H04
		MM5	MX0	—	—	—	GQ1
LL2 V6 2.8 Liter EFI (Reqs N40 Steering)	MM4			—	*GQ1	GT4	—
		MM5	MX0	—	—	*GQ1	H04
W/NA6 HIGH ALTITUDE EMISSION EQUIPMENT							
—S10516							
LN8 L4 2.5 Liter EFI	MM4	MM5	MX0	—	—	—	GQ1
				—	—	GQ1	—
LL2 V6 2.8 Liter EFI (Reqs N40 Steering)	MM4		MX0	—	—	—	GQ1
		MM5		—	—	—	GQ1
—T10516							
LN8 L4 2.5 Liter EFI	MM4	MM5	MX0	—	—	—	GQ1
				—	—	*GQ1	\$H04
LL2 V6 2.8 Liter EFI (Reqs N40 Steering)	MM4			—	—	*GQ1	\$H04
		MM5	MX0	—	—	*GQ1	H04

CALIFORNIA ONLY

ENGINE	TRANSMISSION			AXLES			
	4-SP	5-SP	AUTO	3.42	3.73	4.11	
W/YF5 CALIFORNIA EMISSION REQUIREMENTS							
—S10516							
LN8 L4 2.5 Liter EFI	MM4		MX0	—	—	GQ1	H04
		MM5		—	—	—	GQ1
LL2 V6 2.8 Liter EFI (Reqs N40 Steering)	MM4		MX0	—	GQ1	GT4	—
		MM5		—	—	GQ1	H04
				—	—	—	—
—T10516							
LN8 L4 2.5 Liter EFI	MM4			—	—	*GQ1	\$H04
		MM5	MX0	—	—	—	GQ1
LL2 V6 2.8 Liter EFI (Reqs N40 Steering)	MM4			—	—	*GQ1	\$H04
		MM5	MX0	—	—	*GQ1	H04

*N/A P235/75R15 Tires
\$Reqs P235/75R15 Tires

ENGINE RATINGS—ALL STATES

SAE Net Ratings @ 85°F	2.5 Liter 151 EFI L4	2.8 Liter 173 EFI V6
Net Horsepower	92 @ 4400 rpm	125 @ 4800 rpm
Net Torque, lb-ft	130 @ 3200 rpm	150 @ 2400 rpm

S10 2 AND 4 WHEEL DRIVE BLAZER (1000-lb Payload)

1987 VEHICLES WITH STANDARD EQUIPMENT

Prices shown are effective with initial shipments of 1987 model motor vehicles

Description	Model Number	Body Code	Wheel Base	Factory D&H(a)	List Price	Mfr's Suggested Retail Price*	Group Number
◆ 4-Cylinder 2.5 Liter E.F.I. L4 Gasoline Engine-Engine Ordering Code LN8							
S10 Series 2-Wheel Drive							
Tailgate	CS10516	E55	100.5"	N.A.	10124.00	10124.00	15
S10 Series 4-Wheel Drive							
Tailgate	CT10516	E55	100.5"	N.A.	11588.00	11588.00	15

★ Manufacturer's Suggested Retail Prices do not include applicable destination charges, state and local taxes, license fees, optional equipment or special items or services.

◆ Refer to Power Team Chart for California Emission Certification Requirements.

OPTIONS WHEN INSTALLED BY GENERAL MOTORS

Prices shown are effective with initial shipments of 1987 model motor vehicles

Description	Option Number	Factory D&H(a)	List Price	Mfr's Suggested Retail Price◇
Tahoe/Sierra Classic Equipment: (See Interior and Exterior Color Selection Charts) Includes color-keyed door handle inserts, B84 Body Side and Bright Wheel Opening Moldings, black quarter window moldings, special tailgate applique, nameplate on instrument panel, special door trim with coin holder in LH door panel, deluxe armrests and map pockets, special color-keyed carpeting, D34 Visor Mirror, special body insulation and Z53 Gage Package with Trip Odometer. Also includes P17 Spare Tire Cover when P16 Spare Tire and Wheel Carrier is not specified				
Without YH9. Includes P08 Trim Rings	YC2	N.A.	657.00	657.00
With YH9	YC2	N.A.	447.00	447.00
Sport/Gypsy Equipment: (See Interior and Exterior Color Selection Charts) Available only when ZY7 Sport or ZY6 Custom Two-Tone Paint and Sport Cloth Trim or Leather is specified. Includes A78 Reclining Seat Backs, D55 Console, VE6 Color-Keyed Front and Rear Bumpers, black door handle inserts, B84 Body Side and Black Wheel Opening Moldings, black quarter window moldings, special tailgate applique, nameplate on instrument panel, special door trim with coin holder in LH door panel, deluxe armrests and map pockets, color-keyed carpeting, D34 Visor Mirror, special body insulation and Z53 Gage Package with Trip Odometer. Also includes P17 Spare Tire Cover when P16 Spare Tire and Wheel Carrier is not specified				
S10516 only. Includes ZJ7 Rally Wheels	YC3	N.A.	1042.00	1042.00
T10516 only				
Without YH9. Includes P06 Trim Rings	YC3	N.A.	1012.00	1012.00
With YH9	YC3	N.A.	645.00	645.00
Seat Trim: (See Interior and Exterior Color Selection Chart for availability and ordering information).				
X**4 Custom Vinyl High Back Buckets. Driver and Passenger. Not available when YC3 is specified			NO ADDITIONAL CHARGE
H**4 Special Custom Cloth High Back Buckets. Available only when YC2 is specified			NO ADDITIONAL CHARGE
D**4 Deluxe Cloth High Back Buckets. Driver and Passenger. Available only when YC3 is specified.				
Without AM7 Rear Seat			NO ADDITIONAL CHARGE
With AM7 Rear Seat	N.A.	26.00	26.00
A**6 Leather High-Back Reclining Buckets. Available only when YC2 or YC3 is specified.				
With YC2				
Without AM7 Rear Seat	N.A.	386.00	386.00
With AM7 Rear Seat	N.A.	486.00	486.00
With YC3				
Without AM7 Rear Seat	N.A.	312.00	312.00
With AM7 Rear Seat	N.A.	412.00	412.00
B**4 High Country Sheepskin High-Back Buckets	N.A.	320.00	320.00

(a) D & H Charges on vehicle and optional equipment include reimbursement to ordering Division for any tax that it has paid, incurred or agreed to pay thereon.

◇ State and local taxes not included.

S10/15 2 AND 4 WHEEL DRIVE BLAZER/JIMMY

OPTIONS WHEN INSTALLED BY GENERAL MOTORS

Prices shown are effective with initial shipments of 1987 model motor vehicles

Description	Option Number	Factory D&H(a)	List Price	Mfr's Suggested Retail Price ◇
Paints, Exterior: (See Interior and Exterior Color Selection Chart for ordering information and paint application).				
Solid	ZY1		NO ADDITIONAL CHARGE	
Custom Two-Tone. Includes dual-tone body striping				
Without YC3	ZY6	N.A.	212.00	212.00
With YC3	ZY6		NO ADDITIONAL CHARGE	
Special Two-Tone. Middle area painted Color Code Two choice.				
Without YC2. Includes B84 Body Side and Bright Wheel Opening Moldings	ZY8	N.A.	329.00	329.00
With YC2	ZY8	N.A.	177.00	177.00
Sport Two-Tone. Included when YC3 is specified.				
Without YC2. Includes striping that matches Color Code Two paint color except when YC3 is specified. Area below striping painted Color Code Two choice	ZY7	N.A.	240.00	240.00
With YC2. Area below B84 Body Side and Bright Wheel Opening Moldings painted Color Code Two choice	ZY7	N.A.	172.00	172.00
Emission Systems: Dealer Note - One of the following emission options must be specified. (See Power Teams Chart for Engine and Transmission Availability). California Emission Requirements. Includes all testing, equipment and /or certification necessary for registration in the state of California. Not Available when NA5 Standard or NA6 High Altitude Emissions are specified				
High Altitude Emission Equipment	YF5		NO ADDITIONAL CHARGE	
Standard Emission Equipment. Not available when YF5 California or NA6 High Altitude Emissions are specified	NA6		NO ADDITIONAL CHARGE	
	NA5		NO ADDITIONAL CHARGE	
Engines: (See Power Teams Chart for availability and complete specifications)				
Gasoline				
2.5 Liter E.F.I. L4	LN8		NO ADDITIONAL CHARGE	
2.8 Liter E.F.I. V6. Available only when N40 Power Steering is specified	LL2	N.A.	295.00	295.00
Transmissions: (See Power Teams Chart for availability and complete specifications).				
3-Speed Automatic. S1 series only	MX1	N.A.	565.00	565.00
4-Speed Automatic with Overdrive	MX0	N.A.	735.00	735.00
4-Speed Manual	MM4		NO ADDITIONAL CHARGE	
5-Speed Manual with Overdrive	MM5	N.A.	185.00	185.00
Axles, Rear: (See Power Teams Chart for option number selection, availability and complete specifications)				
Optional Ratio	N.A.	38.00	38.00
Locking Differential	G80	N.A.	252.00	252.00
Tires: Includes Compact Spare Tire				
All wheel size, Front and Rear are 6.00" except when QEB Tires or N90 Wheels are specified, then wheel size is 7.00".				
TUBELESS				
P195/75R15 All Seasons Steel Belted Radial Ply Blackwall. (Standard) (Maximum Capacity 1342-lbs)	QAR		NO ADDITIONAL CHARGE	
P195/75R15 All Seasons Steel Belted Radial Ply Whitewall. (Maximum Capacity 1342-lbs)	QAS	N.C.	68.00	68.00
P205/75R15 All Seasons Steel Belted Radial Ply Blackwall (Maximum Capacity 1453-lbs)	QCE	N.C.	33.00	33.00
P205/75R15 On-Off Road Steel Belted Radial Ply White Lettered (Maximum Capacity 1453-lbs)	QJL	N.C.	167.00	167.00
P205/75R15 All Seasons Steel Belted Radial Ply White Lettered (Maximum Capacity 1453-lbs)	QCF	N.C.	129.00	129.00
P205/75R15 On-Off Road Steel Belted Radial Ply Blackwall (Maximum Capacity 1453-lbs)	QJT	N.C.	71.00	71.00
P235/75R15 On-Off Road Steel Belted Radial Ply White Lettered (Maximum Capacity 1453-lbs). T1 Series only. Available only when ZK5 Full Size Spare Tire is specified. Included when Z71 Chassis Equipment Package is specified	QEB	N.C.	311.00	311.00
P205/75R15 On-Off Road Steel Belted Radial Ply Blackwall (Front Highway, Rear On-Off Road) (Maximum Capacity 1453-lbs). S1 Series only	Q1C	N.C.	51.00	51.00

(a) D & H Charges on vehicle and optional equipment include reimbursement to ordering Division for any tax that it has paid, incurred or agreed to pay thereon.
◇ State and local taxes not included.

S10/15 2 AND 4 WHEEL DRIVE BLAZER/JIMMY

OPTIONS WHEN INSTALLED BY GENERAL MOTORS

Prices shown are effective with initial shipments of 1987 model motor vehicles

Description	Option Number	Factory D&H(a)	List Price	Mfr's Suggested Retail Price◇
OTHER OPTIONS				
Air Cleaner, Pre-Cleaner: Available only when LL2 2.8 Liter Engine is specified	K46	N.A.	44.00	44.00
Air Conditioning: <i>All-Weather.</i> Available only when N40 Power Steering is specified. Includes V01 H.D. Radiator when V02 H.D. Radiator and Transmission Oil Cooler is not specified.	C60	N.A.	745.00	745.00
Battery: <i>Heavy-Duty.</i> 630 Cold Cranking Amps, Delco Freedom. Included when V10 Cold-Climate Package is specified	UA1	N.A.	56.00	56.00
Bumper Equipment:				
<i>Bumpers, Painted.</i> Color-Keyed with rub strips. Front and Rear. Available only when ZY6 Custom, ZY7 Sport or ZY8 Special Two-Tone Paint is specified. Included when YC3 or YH9 High Country Package is specified	VE6 V28	N.A.	NO ADDITIONAL CHARGE 32.00	32.00
<i>Bumper Guards, Front, Black</i>				
Carriers, Luggage:				
Bright. Not available when YC3 or YH9 High Country Package is specified	V55	N.A.	126.00	126.00
Black	V54	N.A.	126.00	126.00
Carrier, Spare Wheel and Tire: Not available when P17 Spare Tire Cover is specified. Available only when Full Size Spare Tire is specified. Includes exterior cover				
Without YC2 or YC3	P16	N.A.	192.00	192.00
With YC2 or YC3	P16	N.A.	159.00	159.00
Chassis Equipment: <i>Off-Road Package.</i> T10516 only. Not available when F51 H.D. Shock Absorbers are specified. Includes QEB P235/75R15 tires, ZK5 Full Size Spare, special torsion bars, shock absorbers, jounce bumpers, front stabilizer, V76 Tow Hooks and NY7 Transfer Case Shield				
Without YC2 or YC3. Includes P06 Trim Rings	Z71	N.A.	693.00	693.00
With YC2 or YC3	Z71	N.A.	637.00	637.00
Cold-Climate Package: Includes UA1 H.D. Battery and special insulation.				
Without YC2 or YC3	V10	N.A.	156.00	156.00
With YC2 or YC3	V10	N.A.	113.00	113.00
Console: <i>Front Compartment Floor.</i> Included when YC3 or YH9 High Country Package is specified	D55	N.A.	114.00	114.00
Cooling System:				
<i>Engine Oil, S1 Series only.</i> Available only when LL2 2.8 Liter Engine, MX0 or MX1 Automatic Transmission and V01 H.D. Radiator or V02 H.D. Radiator and Transmission Oil Cooler are specified	KC4	N.A.	126.00	126.00
<i>Radiator, Heavy-Duty.</i> Not available when V02 H.D. Radiator and Transmission Oil Cooler is specified. Included when C60 Air Conditioning is specified	V01	N.A.	56.00	56.00
<i>Radiator and Transmission Oil, Heavy-Duty.</i> T1 Series available only when LL2 2.8 Liter Engine and MX0 Automatic Transmission are specified. S1 Series available only when LL2 2.8 Liter Engine and MX0 or MX1 Automatic Transmission is specified				
Without C60 Air Conditioning	V02	N.A.	118.00	118.00
With C60 Air Conditioning	V02	N.A.	63.00	63.00
Cover, Spare Tire: Included when YC2 or YC3 is specified. Not available when P16 Spare Wheel Tire Carrier is specified	P17	N.A.	33.00	33.00
Deflector, Air	C51	N.A.	43.00	43.00
Defogger, Rear Window: <i>Electric.</i>	C49	N.A.	154.00	154.00
Door Lock System, Power: <i>Side Doors only.</i> Included when ZQ2 Operating Convenience Package is specified	AU3	N.A.	144.00	144.00
Floor Covering:				
<i>Mats, Color-Keyed, Removable.</i> Not available when BG9 Full Floor Covering is specified. Available only when YC2 or YC3 is specified.				
Front	B32	N.A.	16.00	16.00
Rear	B33	N.A.	12.00	12.00
<i>Full Floor, Rubber, Color-Keyed.</i> Replaces carpeting when YC2 or YC3 is specified. Available only when YC2 or YC3 is specified	BG9		NO ADDITIONAL CHARGE	
Gages:				
<i>Voltmeter, Temperature, Oil Pressure and Trip Odometer.</i> Included when YC2, YC3 or U16 Tachometer is specified	Z53	N.A.	62.00	62.00
<i>Tachometer.</i>				
Without YC2 or YC3. Includes Z53 Gage Package	U16	N.A.	120.00	120.00
With YC2 or YC3	U16	N.A.	59.00	59.00

(a) D & H Charges on vehicle and optional equipment include reimbursement to ordering Division for any tax that it has paid, incurred or agreed to pay thereon.

◇ State and local taxes not included.

S10/15 2 AND 4 WHEEL DRIVE BLAZER/JIMMY

OPTIONS WHEN INSTALLED BY GENERAL MOTORS

Prices shown are effective with initial shipments of 1987 model motor vehicles

Description	Option Number	Factory D&H(a)	List Price	Mfr's Suggested Retail Price◇
OTHER OPTIONS				
Glass:				
Deep Tinted. Includes dark laminated glass on rear quarters and rear window Without YH9	AJ1	N.A.	200.00	200.00
With YH9	AJ1	N.A.	56.00	56.00
Deep Tinted with Light Tinted Rear Window. Not available when AJ1 Deep Tinted Glass is specified. Included with YH9 High Country Package. Includes dark laminated glass on rear quarter windows	AA3	N.A.	144.00	144.00
Headlamps, Halogen				
	TT4	N.A.	24.00	24.00
Heater, Engine Block: 600 watts, 120 volts.				
	K05	N.A.	33.00	33.00
High Country/Timberline Package: Not available when D90 Sunshine or D98 Rally Striping is specified. Available only when YC2, YC3, white lettered tires, ZY6 Custom Two-Tone Paint, Saddle Tan Custom Cloth or Saddle Tan Leather Trim is specified. Includes AA3 Deep Tinted Glass, Gold Painted Cast Aluminum Wheels, exterior black-out package, D44 Mirrors, special nameplates, stripe decal and VE6 Color-Keyed Bumpers				
With YC2. Also includes D55 Console and A78 Reclining Seat Backs	YH9	N.A.	1025.00	1025.00
With YC3	YH9	N.A.	925.00	925.00
Lamp, Engine Compartment				
	U26	N.A.	16.00	16.00
Mirrors, Exterior: LH and RH. Below-Eye-Line Type. 7.25" x 6".				
Painted. Included with YH9 High Country Package	D44	N.A.	52.00	52.00
Bright. Not available when YC3 is specified	D45	N.A.	87.00	87.00
Mirror, Visor: RH. Included when YC2 or YC3 is specified	D34	N.A.	7.00	7.00
Moldings:				
Body Side and Wheel Opening. Included when YC2, YC3 or ZY8 Special Two-Tone Paint is specified. Includes lower side and rear moldings of black plastic with bright trim and wheel opening moldings.				
Without ZY7 Sport Two-Tone Paint	B84	N.A.	152.00	152.00
With ZY7 Sport Two-Tone Paint	B84	N.A.	83.00	83.00
Guards, Door Edge Not available when YH9 High Country Package is specified	B93	N.A.	18.00	18.00
Wheel Opening.				
Bright. Not available when YC3 is specified. Included when YC2 or ZY8 Special Two-Tone Paint is specified. Also included with B84 Body Side and Wheel Opening Moldings except when YC3 is specified	B96	N.A.	31.00	31.00
Black. Included when YC3 is specified. Not available when B96 Bright Wheel Opening Moldings are specified				
Without B84 Body Side and Wheel Opening Moldings	B74	N.A.	43.00	43.00
With B84 Body Side and Wheel Opening Moldings	B74	N.A.	13.00	13.00
Operating Convenience Package: Includes AU3 Power Door Locks and A31 Power Windows				
	ZQ2	N.A.	344.00	344.00
Preliminary Price Information				
	B3W	N.A.	N.A.	N.A.
Radio Equipment:				
AM Radio	U63	N.A.	122.00	122.00
AM/FM Radio	U69	N.A.	181.00	181.00
AM/FM Stereo Radio. Electronically Tuned	UU9	N.A.	249.00	249.00
AM/FM Stereo Radio with Seek and Scan and Digital Clock. Electronically Tuned	UM7	N.A.	308.00	308.00
AM/FM Stereo Radio with Seek and Scan, Stereo Cassette Tape and Digital Clock. Electronically Tuned. Includes U66 Premium Dual Rear Speakers	UM6	N.A.	454.00	454.00
AM Stereo and FM Stereo Radio with Seek and Scan, Stereo Cassette Tape with Search and Repeat, Digital Clock and Graphic Equalizer. Electronically Tuned. Includes U66 Premium Dual Rear Speakers	UX1	N.A.	604.00	604.00
Speakers, Premium Dual Rear. Available only when UU9 or UM7 Radio is specified. Included with UM6 or UX1 Radio	U66	N.A.	27.00	27.00
Seats: (Dealer Note— AM7 Rear Seat or YG4 Rear Seat Not Desired must be specified. Added weight reflects optional seat weight only. Refer to vehicle and option weight section of Data Book)				
Folding Rear Bench. Includes armrests	AM7	N.A.	359.00	359.00
Optional Seat Not Desired	YG4	NO ADDITIONAL CHARGE		
Seat Backs, Reclining. R.H. and L.H. Included when YC3 or YH9 High Country Package is specified	A78	N.A.	74.00	74.00

(a) D & H Charges on vehicle and optional equipment include reimbursement to ordering Division for any tax that it has paid, incurred or agreed to pay thereon.

◇ State and local taxes not included.

S10/15 2 AND 4 WHEEL DRIVE BLAZER/JIMMY

OPTIONS WHEN INSTALLED BY GENERAL MOTORS

Prices shown are effective with initial shipments of 1987 model motor vehicles

Description	Option Number	Factory D&H(a)	List Price	Mfr's Suggested Retail Price◇
OTHER OPTIONS				
Shield, Transfer Case: T1 Series only. Included when Z71 Chassis Equipment is specified	NY7	N.A.	75.00	75.00
Shock Absorbers: Heavy-Duty, Front and Rear. Not available when Z71 Chassis Equipment is specified. Included when F60 H.D. Front Suspension is specified	F51	N.A.	36.00	36.00
Spare Tire: Full size. Included with Z71 Chassis Equipment. Replaces Standard Compact Spare				
Highway				
With QAR P195/75R15 All Seasons Steel Belted Radial Ply Blackwall	ZK4	N.C.	48.00	48.00
With QAS P195/75R15 All Season Steel Belted Radial Ply Whitewall	ZK4	N.C.	51.00	51.00
With QCE P205/75R15 All Seasons Steel Belted Radial Ply Blackwall	ZK4	N.C.	55.00	55.00
With QCF P205/75R15 All Seasons Steel Belted Radial Ply White Lettered	ZK4	N.C.	74.00	74.00
With Q1C P205/75R15 Highway (Front) On-Off Road (Rear) Steel Belted Radial Ply Blackwall, S1 Series only	ZK4	N.C.	55.00	55.00
On-Off Road				
With QJT P205/75R15 Steel Belted Radial Ply Blackwall On-Off Road Front and Rear Tire	ZK5	N.C.	58.00	58.00
With QJL P205/75R15 On-Off Road Steel Belted Radial Ply White Lettered	ZK5	N.C.	76.00	76.00
With QEB P235/75R15 Steel Belted Radial Ply White Lettered On-Off Road Front and Rear Tires. Mounted flat in loadspace. T1 Series only. Included when Z71 Chassis Equipment is specified	ZK5	N.C.	96.00	96.00
With Q1C P205/75R15 Steel Belted Radial Ply Blackwall On-Off Road	ZK5	N.C.	58.00	58.00
Speed Control, Electronic	K34	N.A.	205.00	205.00
Steering: (One of the following steering options must be specified.)				
Power	N40	N.A.	275.00	275.00
Power, Not Desired. Not available when Z82 Trailing Special is specified	N51	NO ADDITIONAL CHARGE		
Steering Wheel: Comfortilt	N33	N.A.	121.00	121.00
Striping, Body: Available only when ZY1 Solid Paint and the following stripe color is specified. Not available when B84 Body Side and Wheel Opening Moldings, YC2 or YC3 is specified. Included when ZY7 Sport Two-Tone Paint is specified. (See Interior and Exterior Color Availability Charts for Ordering Information)	D85	N.A.	69.00	69.00
Stripe Color:				
Black	19A	NO ADDITIONAL CHARGE		
Blue, Dark	28A	NO ADDITIONAL CHARGE		
Gold Available only when D98 Rally Striping is specified	67A	NO ADDITIONAL CHARGE		
Red	72A	NO ADDITIONAL CHARGE		
Silver	17A	NO ADDITIONAL CHARGE		
White	12A	NO ADDITIONAL CHARGE		
Rally Striping: Available only when ZY1 Paint and stripe color are specified. (See Interior and Exterior Color Availability Charts for Ordering Information)	O98	N.A.	84.00	84.00
Sunshine Striping: Available only when ZY1 Solid or ZY6 Custom Two-Tone Paint is specified. Includes 4 Decal stripes along full length of vehicle. (See Interior and Exterior Color Availability Charts for Ordering Information.) Available only when stripe color is specified	D90	N.A.	116.00	116.00
Suspension Equipment: Front, Heavy-Duty, T1 series only. Includes F51 H.D. front and rear shock absorbers. Recommended for snowplow type usage only	F60	N.A.	63.00	63.00
Tailgate Window Release: Power	AU6	N.A.	43.00	43.00
Tank, Fuel: LH Frame Mounted. Replaces Standard Production Fuel Tank. Approximately 20-gallon capacity	NK2	N.A.	51.00	51.00
Towing Device: Two Front Towing Hooks. T1 Series only. Included when Z71 Chassis Equipment is specified	V76	N.A.	38.00	38.00
Trailer Hitch: Dead Weight Type. 2,000-lb Capacity. Not available when Z82 Trailing Special is specified. Included when Z72 Trailing Special is specified	VR2	N.A.	68.00	68.00

(a) D & H Charges on vehicle and optional equipment include reimbursement to ordering Division for any tax that it has paid, incurred or agreed to pay thereon.

◇ State and local taxes not included.

S10/15 2 AND 4 WHEEL DRIVE BLAZER/JIMMY

OPTIONS WHEN INSTALLED BY GENERAL MOTORS

Prices shown are effective with initial shipments of 1987 model motor vehicles

Description	Option Number	Factory D&H(a)	List Price	Mfr's Suggested Retail Price [◇]
OTHER OPTIONS				
Trailer Special: (See Trailing Guide for GCW ratings with available power team combinations.)				
Heavy-Duty. Available only when LL2 2.8 Liter Engine, N40 Power Steering and V02 H.D. Radiator and Transmission Oil Cooler are specified. T1 Series available only when MX0 Automatic Transmission and 4.11 Rear Axle Ratio are specified. S1 Series available only when MX0 Automatic Transmission and 3.73 Rear Axle Ratio or MX1 Automatic Transmission and 4.11 Rear Axle Ratio are specified. Includes 7-lead wiring harness, weight distributing hitch platform and H.D. flasher				
	Z82	N.A.	211.00	211.00
Light Duty. Available only when V01 H.D. Cooling, V02 H.D. Radiator and Transmission Oil Cooler or C60 Air Conditioning are specified. With LN8 2.5 Liter Engine available only when 4.11 Rear Axle Ratio is specified. S1 Series available only when MX0 or MX1 Automatic Transmission is specified. T1 Series available only when MX0 Automatic Transmission is specified. Includes 5-lead wiring harness and VR2 Dead Weight Trailer Hitch.				
	Z72	N.A.	109.00	109.00
Wheel Trim: Trim Rings.				
S1 Series only. Not available when ZJ7 Rally Wheels or YC3 is specified. Included with YC2				
	P06	N.A.	60.00	60.00
T1 Series only. Included when Z71 Chassis Equipment, YC2 or YC3 is specified				
	P06	N.A.	60.00	60.00
Wheels:				
Rally. Wheel size 15" x 6.5". S1 Series only. Painted argent with P06 Trim Rings and special hub caps. Four wheels only. Included with YC3				
	ZJ7	N.A.	92.00	92.00
Without YC2				
	ZJ7	N.A.	34.00	34.00
With YC2				
Aluminum, Cast. Wheel size 7". Four wheels only. T1 Series only. Not available when P195 Tires are specified.				
	N90	N.A.	308.00	308.00
Without YC2, YC3 or Z71 Chassis Equipment				
	N90	N.A.	252.00	252.00
With YC2, YC3 or Z71 Chassis Equipment				
Wheel, Spare: Aluminum, Cast. T1 Series only. Available only when N90 Aluminum Wheels and ZK4 or ZK5 Spare Tire are specified				
	N79	N.A.	80.00	80.00
Windows:				
Power, Side Doors. Included when ZQ2 Operating Convenience Package is specified				
	A31	N.A.	200.00	200.00
Window, Sliding Side Quarter				
	AD5	N.A.	257.00	257.00
Windshield Wiper System: Intermittent				
	CD4	N.A.	59.00	59.00

(a) D & H Charges on vehicle and optional equipment include reimbursement to ordering Division for any tax that it has paid, incurred or agreed to pay thereon.
[◇] State and local taxes not included.

TECH SPEC'D—S-10/15 BLAZER/JIMMY 4X4 (SNOWPLOW)

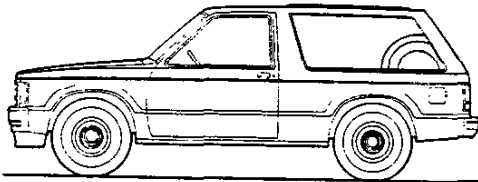

- Model T10516
- GVWR 4,149 to 4,872 lbs.
- Payload 1,000 lbs.

BASIC SPECIFICATIONS

• Engine 2.8 Liter V6 (LL2)	• Tires—Front P205/75R15 On/Off (QJT)
• Transmission 4-Speed Auto (MX0)	—Rear P205/75R15 On/Off (QJT)
• Rear Axle Ratio 4.11 (HO4)	—Spare P205/75R15 On/Off (ZK5)
• Power Brakes (STD)	• Gages (Z53)
• Power Steering (N40)	• Air Conditioning (C60)
• HD Cooling (VO2)	• Mirrors, Below Eyeline (D44)
• Shield, Transfer Case (NY7)	• Radio, AM/FM (U69)
• Battery, HD (UA1)	• Wipers, Intermittent (CD4)
• Suspension Front, HD (F60)	• Defogger, Rear Window (C49)
• Locking Differential, Rear (G80)	• Seat, Folding Rear (AM7)
• Fuel Tank 20-Gal (NK2)	• Cover, Spare Tire (P17)

WEIGHT ANALYSIS

	FRONT	REAR	TOTAL
• Curb Weight	1,662 lbs.	1,487 lbs.	3,149 lbs.
• Option Weight as Equipped	223 lbs.	120 lbs.	343 lbs.
• Total Weight as Equipped	<u>1,885 lbs.</u>	<u>1,607 lbs.</u>	<u>3,492 lbs.</u>
• Gross Axle Weight Rating (GAWR)	2,400 lbs.	2,684 lbs.	

CAUTION: Gross Axle Weight Ratings (GAWR) should never be exceeded.
It is recommended that only a 6½' compact 400-lb weight class plow be utilized on S-10/15 Blazer/Jimmy models.

NOTE: The above items may be included as standard equipment, optional equipment or included as part of an optional equipment package. Refer to the Light-Duty Truck Facts Book/Data Book for details.



EPA RATINGS (ALL STATES)			MODEL
2.8 Liter—V6	City	Hwy	S-10/15 BLAZER/JIMMY 4X4 2.8 LITER V6 SNOWPLOW SPECIFICATIONS
• 4-Speed (M)	16	20	
• 5-Speed (O/D)	16	22	
• 4-Speed Auto (O/D)	16	20	

TECH SPEC'D—S-10/15 BLAZER/JIMMY 4X4 (SNOWPLOW)

COMPONENT SPECIFICATIONS

Engine

- Type: V6 w/EFI
- Size: 2.8 Liter (173 cu. in.)
- Bore & Stroke: 3.50" x 2.99"
- Engine Power Ratings: All States
SAE Net HP 125 @ 4800 RPM
SAE Net Torque 150 @ 2400 RPM
- Compression Ratio: 8.9:1
- Oil Capacity: 4 qts. w/Filter

Cooling

- Crossflow Radiator
- Size: .98 Thick
- Frontal Area: 350 sq. in.
- System Capacity: 3.0 gal.
- Fan
 - No. of Blades: 5
 - Diameter: 15.98"
 - Pitch: 2.83"
 - Temperature Controlled Clutch

Frame

- Material
 - Carbon Steel
 - 36,000-39,000 PSI
- Side Rail Dimensions
 - Width: 2.28"
 - Depth: 5.00"
 - Thickness: .118"
 - Length: 162.46"
- Section Modulus: 1.78
- Width over rails
 - Front: 30.9"
 - Rear: 40.35"

Front Suspension

- Type: Independent Torsion Bar
- Capacity: 2,400 lbs.
- Springs: Torsion Bar
 - 1,200 lb. each @ ground
- Shock Absorbers
 - 32mm diameter

Steering

- Hydraulic Power
 - Integral Type
- Turning Circle Diameter
 - Tire: 35.44 ft.
 - Bumper: 37.17 ft.

Rear Axle/Suspension

- Type: Semi-Floating Axle
 - Salisbury Design
- Capacity: 2,700 lbs.
- Hypoid Gearing
- 8.5" Diameter Ring Gear
- Optional Ratio
 - 4.11:1

Transmission

- Type: 4-Speed Automatic
- Ratio— 1st 3.06
 - 2nd 1.63
 - 3rd 1.00
 - 4th .70
 - Reverse 2.29
- Lubricant Capacity: 19 Pints

Transfer Case

- Type: New Process 207
- Ratio —Lo 2.6:1
 - Hi 1.0:1

Electrical

- Alternator: 85-amps Capacity
 - Delco Model CS 130
 - Ratio: 2.7:1
 - 30-amps @ idle
- Battery
 - Delco Freedom Type
 - Side Terminal
 - 525 CCA @ -20° F
 - Reserve Capacity: 90 min. @ 80° F

Brakes

- Hydraulic; Self-Adjusting
- Front Disc
 - 10.51" Rotor
- Rear Drum
 - 9.49" x 2"
- Effective Lining Area
 - Total 95.41 sq. in.
- Power Booster
 - Vacuum 7.9" x 7.9" Tandem
- Parking Brake
 - Cable to Rear Wheels

Drive Line

- Propeller Shafts
 - Two 2.0" Diameter Front; 2.75" Diameter Rear
- U-Joints
 - Series P23H and S44

Fuel Tank

- Location
 - Inboard LH Frame Rail
- Capacity
 - 20 Gallons
- Filler Location
 - Left Side

Tires

- Size: Front, Rear, Spare
 - P205/75R15
- Type: Radial Blackwall
- Tread: On/Off Road
- Maximum Pressure 35 PSI

Wheels

- Disc 15" x 6.0"
 - Bolt Holes: 5
 - Bolt Hole Circle: 4.75"