



MANUFACTURERS MOTOR VEHICLE SPECIFICATIONS

METRIC (U.S. Customary)

Passenger Car

1987

Manufacturer SUZUKI MOTOR CO., LTD. Hamamatsu-Nishi P.O. Box 1, 432-91, Hamamatsu, Japan	Car Line CHEVROLET SPRINT	
Mailing Address Chevrolet-Pontiac-Canada Group Engineering Center General Motors Corporation 30003 Van Dyke Warren, MI 48090-9060	Issued September, 1986	Revised

Questions concerning these specifications should be directed to the manufacturer whose address is shown above.

The information contained herein is prepared, distributed by, and is solely the responsibility of the automobile manufacturing company to whose products it relates. This specification form was developed by the automobile manufacturing companies under the auspices of the Motor Vehicle Manufacturers Association of the United States, Inc.

The General Specifications herein are those in effect at date of compilation and are subject to change without notice by the manufacturer.

Blank Forms Provided by Technical Affairs Division



Motor Vehicle Manufacturers Association
of the United States, Inc.

MVMA Specifications Form

Passenger Car

METRIC (U.S. Customary)

Table of Contents

1	Car Models
2	Power Teams
3-6	Engine
4	Lubrication System
4	Diesel Information
5	Cooling System
6	Fuel System
7	Vehicle Emission Control
7	Exhaust System
8-10	Transmission, Axles and Shafts
11	Suspension-Front and Rear
12-13	Brakes
13	Tires and Wheels
14-15	Steering
15-16	Electrical
17	Body – Miscellaneous Information
18	Restraint System
18	Frame
18	Glass
19	Convenience Equipment
20-22	Car and Body Dimensions
23	Vehicle Fiducial Marks
24	Lamps and Headlamps
25	Vehicle Mass (Weight)
26	Optional Equipment Differential Mass (Weight)
27-33	Car and Body Dimensions Definitions - Key Sheets
34	Index

NOTE:

1. This form uses both SI metric units and U.S. Customary units. The metric unit of measure is presented first, and the U.S. Customary unit follows in parentheses.
2. UNLESS OTHERWISE INDICATED:
 - a. Specifications apply to standard models without optional equipment. Significant deviations are noted.
 - b. Nominal design dimensions are used throughout these specifications.
 - c. All linear dimensions are in millimeters (inches), and all mass (weight) specifications are in kilograms (pounds).
3. The General Specifications herein are those in effect at date of completion and are subject to change without notice by the manufacturer.
4. Additional Car and Body Dimensions (based in part on SAE J1100 "Motor Vehicle Dimensions") may be available from the manufacturer.

MVMA Specifications Form

Passenger Car

METRIC (U.S. Customary)

Interior Car And Body Dimensions - Key Sheet

Dimensions Definitions

- H104 REAR BUMPER TO GROUND. The minimum dimension measured vertically from the lowest point on the rear bumper to ground, including bumper guards, if standard equipment.
- H105 REAR BUMPER TO GROUND - CURB MASS (WT.). Measured in the same manner as H104.
- H106 ANGLE OF APPROACH. The angle measured between a line tangent to the front tire static loaded radius arc and the initial point of structural interference forward of the front tire to ground. The limiting structural component shall be designated.
- H107 ANGLE OF DEPARTURE. The angle measured between a line tangent to the rear tire static loaded radius arc and the initial point of structural interference rearward of the rear tire to ground. The limiting component shall be designated.
- H147 RAMP BREAKOVER ANGLE. The angle measured between two lines tangent to the front and rear tire static loaded radius and intersecting at a point on the underside of the vehicle which defines the largest ramp over which the vehicle can roll.
- H153 REAR AXLE DIFFERENTIAL TO GROUND. The minimum dimension measured from the rear axle differential to ground.
- H156 MINIMUM RUNNING GROUND CLEARANCE. The minimum dimension measured from the sprung vehicle to ground. Specify location.

Glass Areas

- S1 Windshield area.
- S2 Side windows area. Includes the front door, rear door, vents, and rear quarter windows on both sides of the vehicle.
- S3 Backlight areas.
- S4 Total area. Total of all areas (S1 + S2 + S3).

Fiducial Mark Dimensions

- Fiducial Mark - Number 1**
- L54 "X" coordinate.
- W21 "Y" coordinate.
- H81 "Z" coordinate.
- H161 Height "Z" coordinate to ground at curb weight.
- H163 Height "Z" coordinate to ground.
- Fiducial Mark - Number 2**
- L55 "X" coordinate.
- W22 "Y" coordinate.
- W82 "Z" coordinate.
- H162 Height "Z" coordinate to ground at curb weight.
- H164 Height "Z" coordinate to ground.

Front Compartment Dimensions

- L7 STEERING WHEEL TORSO CLEARANCE. The minimum dimension measured in the side view from the rearmost edge of the steering wheel, with front wheels in the straight ahead position, to the torso line.
- L11 ACCELERATOR HEEL POINT TO STEERING WHEEL CENTER. The dimension measured horizontally from the AHP to the intersection of the steering column centerline and a plane tangent to the upper surface of the steering wheel rim.
- L17 DESIGN H-POINT-FRONT TRAVEL. The dimension measured horizontally between the design H-point-front in the foremost and rearmost seat track positions. (See SAE J1100)
- L23 NORMAL DRIVING AND RIDING SEAT TRACK LEVEL. The dimension measured horizontally between a point on the design H-point travel line from the SgRP to the displaced point on the design H-point travel line with the seat moved to the foremost seat position, but not to include seat track travel used for purposes other than normal driving and riding positions. (See SAE J1100)
- L31 SgRP-FRONT. "X" COORDINATED.
- L34 MAXIMUM EFFECTIVE LEG ROOM-ACCELERATOR. The dimension measured along a line from the ankle pivot center to the SgRP-front plus 254 mm (10.0 in) measured with right foot on the undepressed accelerator pedal. For vehicles with SgRP to heel (H30) greater than 18 in., the accelerator pedal may be depressed as specified by the manufacturer. If the accelerator is depressed, the manufacturer shall place foot flat on pedal and note the depression of the pedal.
- L40 BACK ANGLE-FRONT. The angle measured between a vertical line through the SgRP-front and the torso line. If the seatback is adjustable, use the normal driving and riding position specified by the manufacturer.
- L42 HIP ANGLE-FRONT. The angle measured between torso line and thigh centerline.
- L44 KNEE ANGLE-FRONT. The angle measured between thigh centerline and lower leg centerline measured on the right leg.
- L46 FOOT ANGLE-FRONT. The angle measured between the lower leg centerline and a line tangent to the ball and heel of the bare foot flesh line measured on the right leg. Ref SAE J826.
- L53 SgRP-FRONT TO HEEL. The dimension measured horizontally from the SgRP-front to the accelerator heel point.
- W3 SHOULDER ROOM-FRONT. The minimum dimension measured laterally between the trimmed surfaces on the "X" plane through the SgRP-front at height between the belt line and 254 mm (10.0 in.) above the SgRP-front, excluding the door assist strap and attaching parts.
- W5 HIP ROOM-FRONT. The minimum dimension measured laterally between the trimmed surfaces on the "X" plane through the SgRP-front within 25 mm (1.0 in.) below and 76 mm (3.0 in.) above the SgRP-front and 76 mm (3.0 in.) fore and aft of the SgRP-front.
- W9 STEERING WHEEL MAXIMUM OUTSIDE DIAMETER. Define if other than round.
- H13 STEERING WHEEL TO CENTERLINE OF THIGH. The minimum dimension measured from the bottom of steering wheel, with front wheels in the straight position, to the thigh centerline.
- H17 ACCELERATOR HEEL POINT TO THE STEERING WHEEL CENTER. The dimension measured vertically from the AHP-front to the intersection of the steering column centerline to a plane tangent to the upper surface of the steering wheel rim.
- H18 STEERING WHEEL ANGLE. The angle measured from a vertical to the surface plane of the steering wheel.
- H30 SgRP-FRONT TO HEEL. The dimension measured vertically from the SgRP-front to the accelerator heel point.
- H37 HEADLINING TO ROOF PANEL-FRONT. The dimension measured from the intersection of the headlining and the extended effective head room line normal to the sheet metal.
- H50 UPPER BODY OPENING TO GROUND-FRONT. The dimension measured vertically from the trimmed body opening to the ground on the SgRP-front "X" plane.
- H61 EFFECTIVE HEAD ROOM-FRONT. The dimension measured along a line 8 deg. rear of vertical from the SgRP-front to the headlining plus 102 mm (4.0 in.).
- H67 FLOOR COVERING THICKNESS-UNDEPRESSED FRONT. The dimension measured vertically from the surface of the undepressed floor covering to the underbody sheet metal at the accelerator heel point.
- PD1 PASSENGER DISTRIBUTION-FRONT.

Rear Compartment Dimensions

- L3 COMPARTMENT ROOM-SECOND. The dimension measured horizontally from the back of front seat to the front of the second seatback at a height tangent to the top of the second seat cushion.

MVMA Specifications Form

Passenger Car

METRIC (U.S. Customary)

Interior Car And Body Dimensions - Key Sheet

Dimensions Definitions

- L-41 BACK ANGLE-SECOND. The angle measured between a vertical line through the SgRP-second and the torso line.
- L43 HIP ANGLE-SECOND. The angle measured between torso line and thigh centerline.
- L45 KNEE ANGLE-SECOND. The angle measured between thigh centerline and lower leg centerline.
- L47 FOOT ANGLE-SECOND. The angle measured between the lower leg centerline and a line tangent to the ball and heel of the three-dimensional devices bare foot flesh line (Reference JS26).
- L48 KNEE CLEARANCE-SECOND. The minimum dimension measured from the knee pivot center to the back of the front seatback minus 51 mm (2.0 in.).
- L50 SgRP COUPLE DISTANCE-SECOND. The dimension measured horizontally from the driver SgRP-front to the SgRP-second.
- L51 MINIMUM EFFECTIVE LEG ROOM-SECOND. The dimension measured along a line from the ankle pivot center to the SgRP-second plus 254mm (10.0 in.).
- W4 SHOULDER ROOM-SECOND. The minimum dimension measured laterally between door or quarter trimmed surfaces on the "X" plane through the SgRP-second at height between 254-406 mm (10.0-16.0 in.) above the SgRP-second, excluding the door assist straps and attaching parts.
- W6 HIP ROOM-SECOND. Measured in the same manner as W5.
- H31 SgRP-SECOND TO HEEL. The dimension measured vertically from the SgRP-second to the two dimensional device heel point on the depressed floor covering.
- H38 HEADLINING TO ROOF PANEL-SECOND. The dimension measured from the intersection of the headlining and the extended effective head room line normally to the roof sheet metal.
- H51 UPPER BODY OPENING TO GROUND-SECOND. The dimension measured vertically from the trimmed body opening to the ground on the "X" plane 330 mm (13.0 in.) forward of the SgRP-second.
- H63 EFFECTIVE HEAD ROOM-SECOND. The dimension measured along a line 8 deg. rear of vertical from the SgRP to the headlining, plus 102 mm (4.0 in.).
- H73 FLOOR COVERING-DEPRESSED-SECOND. The dimension measured vertically from the heel point to the underbody sheet metal.
- PD2 PASSENGER DISTRIBUTION-SECOND.

Luggage Compartment Dimensions

- V1 USABLE LUGGAGE CAPACITY-Total of volumes of individual pieces of standard luggage set plus H-boxes stowed in the luggage compartment in accordance with the procedure described in paragraph 8.2 of SAE-J1100a.
- H195 LIFTOVER HEIGHT. The dimension measured vertically from the luggage compartment lower opening at the zero "Y" plane to ground.

Interior Volumes (EPA Classification)

The Interior Volume Index is listed for each body style except two seaters. The interior volume index estimates the space in a car. It is based on four measurements - head room, shoulder room, hip room, and leg room - for the front and rear seats, plus trunk capacity. The interior volume index is an estimate of the size of the passenger compartment.

The Trunk Cargo Index is an estimate of the size of the trunk/cargo space. In station wagons and hatchbacks it is an estimate of the space behind the second seat.

Station Wagon - Third Seat Dimensions

- L85 SgRP COUPLE DISTANCE-THIRD. The dimension measured horizontally from the SgRP-second to the SgRP-third.
- L86 EFFECTIVE LEG ROOM-THIRD. The dimension measured along a line from the ankle pivot center to the SgRP-third plus 254 mm (10.0 in.).
- L87 KNEE CLEARANCE-THIRD. The minimum dimension from the knee pivot center to the back of second seatback minus a constant of 51mm (2.0 in.). With rear-facing third seat, dimension is measured to closure.
- L88 BACK ANGLE-THIRD. Measured in the same manner as L41.
- L89 HIP ANGLE-THIRD. Measured in the same manner as L43.
- L90 KNEE ANGLE-THIRD. Measured in the same manner as L45.
- L91 FOOT ANGLE-THIRD. Measured in the same manner as L47.
- W85 SHOULDER ROOM-THIRD. Measured in the same manner as W4.
- W86 HIP ROOM-THIRD. Measured in the same manner as W5.
- H86 EFFECTIVE HEAD ROOM-THIRD. The dimension, measured along a line 8 deg. from the SgRP-third to the headlining rear of vertical plus a constant of 102 mm (4.0 in.).
- H87 SgRP-THIRD TO HEEL POINT.
- PD3 PASSENGER DIRECTION-THIRD.
- SD1 SEAT FACING DIRECTION-THIRD.

Station Wagon - Cargo Space Dimensions

- L200 CARGO LENGTH-OPEN-FRONT. The minimum dimension measured longitudinally from the back of the front seatback at the height of the undepressed floor covering to the rearmost point on the undepressed floor covering on the open tailgate or cargo surface if the rear closure is a conventional door type tailgate at the zero "Y" plane.
- L201 CARGO LENGTH-OPEN-SECOND. The dimension measured longitudinally from the back of the second seatback at the height of the undepressed floor covering to the rearmost point on the undepressed floor covering on the open tailgate or cargo floor surface if the rear closure is a conventional door type tailgate, at the zero "Y" plane.
- L202 CARGO LENGTH-CLOSED-FRONT. The minimum dimension measured horizontally from the back of the front seat at the height of the undepressed floor covering to the rearmost point on the undepressed floor covering on the closed tailgate or taildoor for station wagons, trucks and mpv's at the zero "Y" plane.
- L203 CARGO LENGTH-CLOSED-SECOND. The dimension measured horizontally from the back of the second seat at the height of the undepressed floor covering to the rearmost point on the undepressed floor covering on the closed tailgate or taildoor for station wagons, trucks and mpv's at the zero "Y" plane.
- L204 CARGO LENGTH AT BELT-FRONT. The minimum dimension measured horizontally from the back of the front seatback at the seatback top to the foremost normal surface of the closed tailgate or inside surface of the cab backpanel at the height of the belt, on the zero "Y" plane.
- L205 CARGO LENGTH AT BELT-SECOND. The minimum dimension measured horizontally from the back of the second seatback at the seatback top to the foremost normal surface of the closed tailgate at the height of the belt, on the zero "Y" plane.
- W201 CARGO WIDTH-WHEELHOUSE. The minimum dimension measured laterally between the trimmed wheelhouseings at floor level. For any vehicle not trimmed, measure to the sheet metal.

MVMA Specifications Form

Passenger Car

METRIC (U.S. Customary)

Exterior Car And Body Dimensions - Key Sheet

Dimensions Definitions

Seating Reference Point

SEATING REFERENCE POINT means the manufacturer's design reference point which -

- (a) Establishes the rearmost normal design driving or riding position of each designated seating position in a vehicle;
- (b) Has coordinates established relative to the design vehicle structure;
- (c) Simulates the position of the pivot center of the human torso and thigh; and
- (d) Is the reference point employed to position the two dimensional templates described in SAE Recommended Practice J826, "Devices for Use in Defining and Measuring Vehicle Seating Accommodations."

Width Dimensions

- W101 TREAD-FRONT. The dimension measured between the tire centerlines at the ground.
- W102 TREAD-REAR. The dimension measured between the tire centerlines at the ground. In case of dual wheels, the dimension will be measured to the centerline of tire and wheel assemblies.
- W103 VEHICLE WIDTH. The maximum dimension measured between the widest point on the vehicle, excluding exterior mirrors, flexible mud flaps, marker lamps, but including bumpers, moldings, sheet metal protrusions or dual wheels, if standard equipment.
- W106 FRONT FENDER WIDTH. The dimension measured between the widest points at the front wheel centerline, excluding moldings.
- W107 REAR FENDER WIDTH. The dimension measured between the widest points at the rear wheel centerline, excluding moldings.
- W117 BODY WIDTH AT SgRP-FRONT. The dimension measured laterally between the widest points on the body at the SgRP-front, excluding door handles, applied moldings, or appliques.
- W120 VEHICLE WIDTH-FRONT DOORS OPEN. The dimension measured between the widest point on the front doors in maximum hold-open position.
- W121 VEHICLE WIDTH-REAR DOORS OPEN. The dimension measured between the widest point on the rear doors in maximum hold-open position. For vehicles with a rear door on only one side, this dimension is to the zero "Y" plane.
- W122 TUMBLE-HOME. STRAIGHT SIDE GLASS. The angle measured from a vertical to the outside surface of the front door glass at the SgRP "X" plane.
CURVED SIDE GLASS. The angle measured from a vertical to a chord extending from the upper DLO to the lower DLO at the outside surface of the front door glass at the front SgRP "X" plane.

Length Dimensions

- L101 WHEELBASE (WB). The dimension measured longitudinally between front and rear wheel centerlines. In case of dual rear axles, the dimension shall be to the midpoint of the centerlines of the rear wheels.
- L103 VEHICLE LENGTH. The maximum dimension measured longitudinally between the foremost point and the rearmost point on the vehicle, including bumper, bumper guards, tow hooks and or rub strips, if standard equipment.
- L104 OVERHANG-FRONT. The dimension measured longitudinally from the centerline of the front wheels to the foremost point on the vehicle including bumper, bumper guards, tow hooks and or rub strips, if standard equipment.
- L105 OVERHANG-REAR. The dimension measured longitudinally from the centerline of the rear wheels; or in the case

of dual rear axles, the dimension shall be the midpoint of the centerlines of the rear wheels, to the rearmost point on the vehicle including rear bumpers, bumper guards, tow hooks and rub strips, if standard equipment.

- L123 UPPER STRUCTURE LENGTH. The dimension measured longitudinally from the cowl point to the deck point.
- L125 COWL POINT "X" COORDINATE.
- L126 FRONT END LENGTH. The dimension measured longitudinally from the cowl point to the foremost point on the vehicle at the zero "Y" plane excluding ornamentation or bumpers. In cases where bumpers and/or grills are integrated with the profile, measurement is made at the foremost point of front end contour.
- L127 REAR WHEEL CENTERLINE "X" COORDINATE or in the case of dual rear axles, the coordinate shall be the midpoint of the distance between the rear axle centerlines.
- L129 REAR END LENGTH. The dimension measured longitudinally from the deck point to the rearmost visible point of the body sheet metal at the zero "Y" plane, excluding ornamentation or bumpers.

Height Dimensions

- H101 VEHICLE HEIGHT. The dimension measured vertically from the highest point on the vehicle body to ground.
- H111 ROCKER PANEL-REAR TO GROUND. The dimension measured vertically from the bottom of the rocker or side quarter panel at the front of the rear wheel opening, excluding flanges, to ground.
- H112 ROCKER PANEL-FRONT TO GROUND. The dimension measured vertically from the foremost point on the bottom of the rocker panels, excluding flanges, to ground.
- H114 COWL POINT TO GROUND. Measured at zero "Y" plane.
- H121 BACKLIGHT SLOPE ANGLE. The angle between the vertical reference line and the surface of backlight at vehicle zero "Y" plane. For curve backlight, the angle is to chord of backlight arc from lower DLO to upper DLO.
- H122 WINDSHIELD SLOPE ANGLE. The angle between the vertical reference line and a chord of the windshield arc running from the lower DLO to the upper DLO at the vehicle zero "Y" plane. In the case of wrap over glass, the angle to be measured will be formed by a chord 457 mm (18.0 in) long drawn from the lower DLO to the intersecting point on the windshield.
- H127 HEADLAMP TO GROUND-CURB MASS (WT.). The dimension measured vertically from the centerline of the lowest headlamp lens to ground.
- H128 TAILLAMP TO GROUND-CURB MASS (WT.). The dimension measured vertically from the centerline of the upper bulb to ground.
- H133 BOTTOM OF DOOR CLOSED-FRONT TO GROUND. The dimension measured vertically from the bottom outside corner of the door on the lock pillar side, in maximum closed position, to ground.
- H135 BOTTOM OF DOOR CLOSED-REAR TO GROUND. The dimension measured vertically from the bottom outside corner of the door on the lock pillar side, in maximum closed position, to ground.
- H138 DECK POINT TO GROUND. Measured at zero "Y" plane.
- H109 STATIC LOAD-TIRE RADIUS-REAR. Specified by the manufacturer in accordance with composite TIRE SECTION STANDARD.

Ground Clearance Dimensions

- H102 FRONT BUMPER TO GROUND. The minimum dimension measured vertically from the lowest point on the front bumper to ground, including bumper guards, if standard equipment.
- H103 FRONT BUMPER TO GROUND-CURB MASS (WT.). Measured in the same manner as H102.

MVMA Specifications Form
Passenger Car
METRIC (U.S. Customary)

Exterior Car And Body Dimensions – Key Sheet

Exterior Width

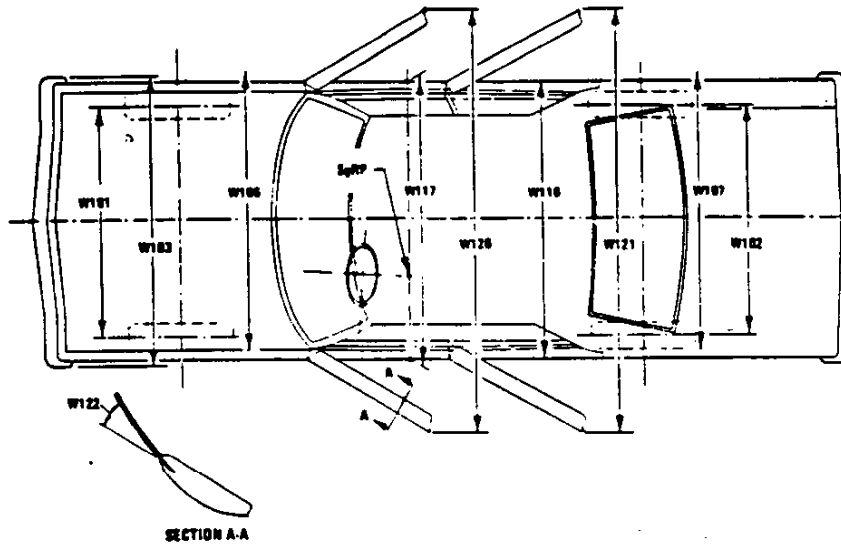

Exterior Length & Height

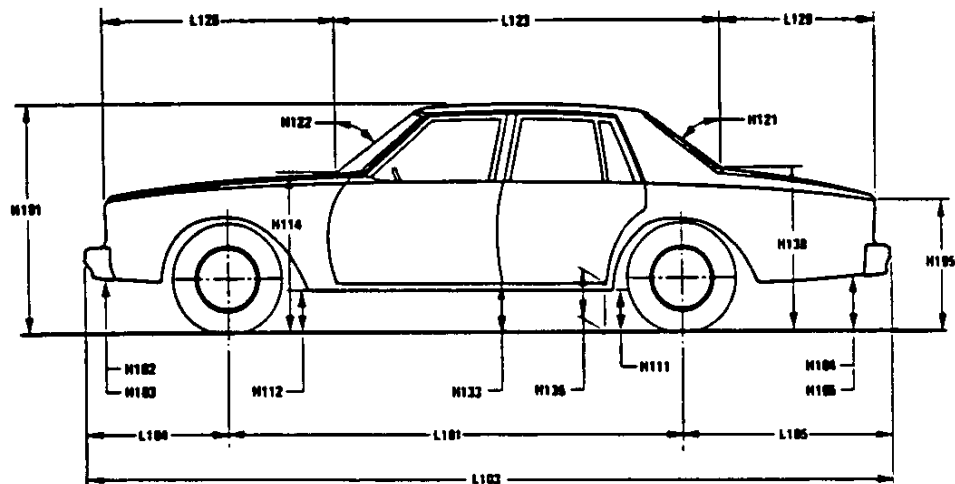

Exterior Ground Clearance

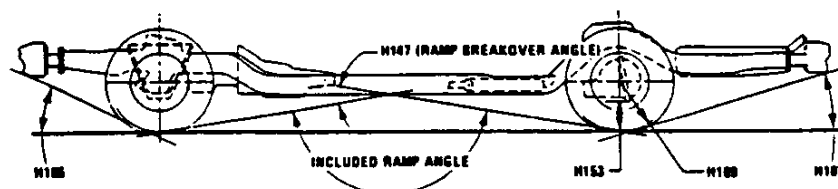

MVMA Specifications Form

Passenger Car

METRIC (U.S. Customary)

Interior Car And Body Dimensions – Key Sheet

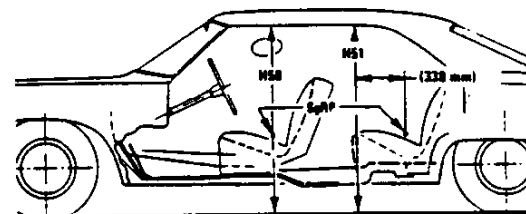
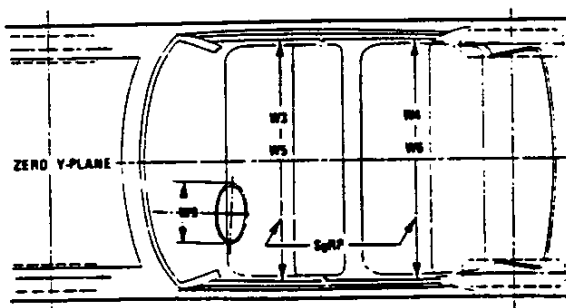
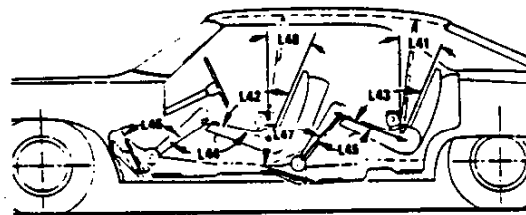
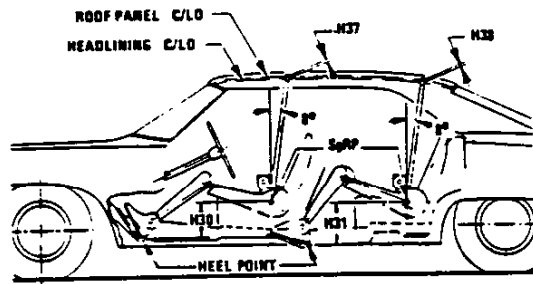
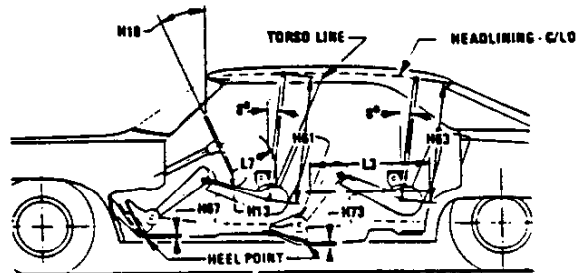
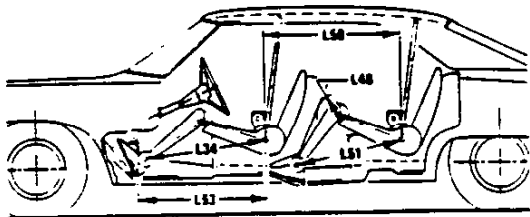

**MVMA Specifications Form
Passenger Car**

Car Line SPRINT/FIREFLY
 Make Year 1987 Issued _____ Revised (or) _____

METRIC (U.S. Customary)

Equipment	Optional Equipment Differential Mass (weight)*			Remarks
	MASS, kg. (weight, lb.)			
	Front	Rear	Total	
Electric Rear Window Defogger	0	0.10	0.10	All models
Air Conditioning and Tinted Glass	16.33	1.17	17.50	2 Door H/B (similar weight distribution for 4 Door H/B)
Tachometer	0.22	0.08	0.30	2 Door H/B (similar weight distribution for 4 Door H/B)
Rear Window Washer & Wiper	-0.50	3.05	2.55	2 Door H/B (similar weight distribution for 4 Door H/B)
Passenger Assist Grip Right Front	0.03 0.06	0.04 0.15	0.07 0.21	2 Door H/B 4 Door H/B
Split Folding Rear Seat Back	0	1.30	1.30	All models
Intermittent Wipers	0.04	0.01	0.05	2 Door H/B (similar weight distribution for 4 Door H/B)
Custom Trim Seat	0	0	0	
Adjustable Head Rest	0.20	0.55	0.75	2 Door H/B (similar weight distribution for 4 Door H/B)
Large Arm Rest	0.20	0.25	0.45	2 Door H/B (similar weight distribution for 4 Door H/B)
Custom Door Trim	0	0	0	
Door Upper Trim	0.04 0.05	0.03 0.08	0.07 0.13	2 Door H/B 4 Door H/B
"B" & "C" Pillar Cover	0.06 0.10	0.20 0.38	0.26 0.48	2 Door H/B 4 Door H/B
Body Side Molding	0.87 0.79	0.88 0.81	1.74 1.60	2 Door H/B " (Canadian version only)
Body Side Molding	1.00 0.80	1.07 0.86	2.06 1.66	4 Door H/B " (Canadian version only)
RH Outside Rear View Mirror				CHEVROLET
Radio - AM/FM				CHEVROLET
Radio - AM/FM Stereo				CHEVROLET

*Also see Engine - General Section for dressed engine mass (weight)

MVMA Specifications Form
Passenger Car
METRIC (U.S. Customary)

Car Line SPRINT
 Model Year 1987 Issued _____ Revised (●) _____

Body Type

2-DOOR HATCHBACK SEDAN 1MR08	4-DOOR HATCHBACK SEDAN 1MR68
------------------------------------	------------------------------------

Lamps and Headlamp Shape*

Height above ground to center of bulb or marker	Headlamp (SAE - H127)	Highest**	635 mm
		Lowest	—
	Tailamp (SAE - H128)	Highest**	730 mm
		Lowest	—
	Sidemarkers	Front	600 mm
		Rear	690 mm
Distance from C-L of car to center of bulb	Headlamp	Inside	—
		Outside**	1,050 mm
	Tailamp	Inside	—
		Outside**	1,250 mm
	Directional	Front	1,070 mm
		Rear	1,140 mm
Halogen headlamp (Std. opt. n.a.)	Lo beam	Standard	
	Hi beam	Standard	
	Replaceable bulb	Standard	
	Shape	Flush	
Headlamp other than above	Lo beam	Not applicable	
	Hi beam	"	
	Replaceable	"	
	Shape	"	
	Type	"	

* Measured at curb mass (weight).
 ** If single lamps are used enter here.
 All linear dimensions are in millimeters (inches) unless otherwise noted.

MVMA Specifications Form
Passenger Car
METRIC (U.S. Customary)
Car and Body Dimensions

Car Line SPRINT
 Model Year 1987 Issued _____ Revised (or) _____

See Key Sheets for definitions

Body Type

SAE Ref. No.	2-DOOR HATCHBACK SEDAN 1MR08	4-DOOR HATCHBACK SEDAN 1MR68
--------------	------------------------------	------------------------------

Station Wagon - Third Seat

Sg RP couple distance	L85	
Shoulder room	W85	
Hip room	W86	Not applicable
Effective leg room	L86	
Effective head room	H86	
Sg RP to heel point	H87	
Knee clearance	L87	
Seat facing direction	SD1	Not applicable
Back angle	L88	
Hip angle	L89	
Knee angle	L90	
Foot angle	L91	

Station Wagon - Cargo Space

Cargo length (open front)	L200	
Cargo length (open second)	L201	
Cargo length (closed front)	L202	
Cargo length (closed second)	L203	
Cargo length at belt (front)	L204	
Cargo length at belt (second)	L205	
Cargo width (wheelhouse)	W201	
Rear opening width at floor	W203	
Opening width at belt	W204	Not applicable
Max. rear opening width above belt	W205	
Cargo height	H201	
Rear opening height	H202	
Tailgate to ground height	H250	
Front seat back to load floor height	H197	
Cargo volume index (m ³ ; ft ³)	V2	
Hidden cargo volume (m ³ ; ft ³)	V4	
Cargo volume index-rear of 2-seat	V10	

Hatchback - Cargo Space

Cargo length at front seatback height	L208	1,026 mm	1,125 mm
Cargo length at floor (front)	L209	1,170 mm	1,270 mm
Cargo length at second seatback height	L210	332 mm	357 mm
Cargo length at floor (second)	L211	552 mm	
Front seatback to load floor height	H197	391 mm	
Second seatback to load floor height	H198	435 mm	
Cargo volume index (m ³ ; ft ³)	V3	0.522 (18.4)	0.571 (20.2)
Hidden cargo volume (m ³ ; ft ³)	V4	—	
Cargo volume index-rear of 2-seat	V11	0.243 (8.6)	0.250 (8.8)

Aerodynamics*

Wheel lip to ground, front	Not available
Wheel lip to ground, rear	"
Frontal area (m ² ; ft ²)	"
Drag coefficient (Cd)	"

* EPA Loaded Vehicle Weight, Loading Conditions
 All linear dimensions are in millimeters (inches) unless otherwise noted.

MVMA Specifications Form
Passenger Car
METRIC (U.S. Customary)

Car Line SPRINT
 Model Year 1987 Issued _____ Revised (#) _____

Body Type	2-DOOR HATCHBACK SEDAN 1MR08	4-DOOR HATCHBACK SEDAN 1MR68
-----------	------------------------------------	------------------------------------

Vehicle Fiducial Marks

Fiducial Mark Number _____ Define Coordinate Location _____

Front Front suspension strut upper center

Rear Rear bumper stay bracket hole center

Fiducial Mark Number

Front	W21*	495	
	L54*	590	
	H81*	550	
	H161*	780	
	H163*	760	

Rear	W22*	510	
	L55*	3,180	3,280
	H82*	215	
	H162*	480	
	H164*	460	

* Reference - SAE Recommended Practice, J182, Motor Vehicle Fiducial Marks.
 All linear dimensions are in millimeters (inches).

MVMA Specifications Form
Passenger Car
METRIC (U.S. Customary)
Car and Body Dimensions See Key Sheets for definitions

Car Line SPRINT
 Mode Year 1987 Issued _____ Revised (or) _____

All dimensions to ground are for comparative purposes only. Dimensions are to be shown for all base body models of each car line.
 SAE Ref. no. refers to the definition published in SAE Recommended Practice J1100 Motor Vehicle Dimensions unless otherwise specified.

Body Type	SAE Ref. No.	2-DOOR HATCHBACK SEDAN	4-DOOR HATCHBACK SEDAN	2-DOOR HATCHBACK SEDAN
Width		1MR08	1MR68	TURSO
Tread (front)	W101	1,335 mm		
Tread (rear)	W102	1,300 mm		
Vehicle width	W103	1,530 mm		1,545 mm
Body width at Sq RP (front)	W117	1,530 mm		
Vehicle width (front doors open)	W120	3,510 mm	3,147 mm	3,510 mm
Vehicle width (rear doors open)	W121	—	2,981 mm	—
Front fender overall width	W106	1,530 mm		
Rear fender overall width	W107	1,526 mm		
Turn-in-tilted	W122	19°55'		

Length

Wheelbase	L101	2,245 mm	2,345 mm	2,245 mm
Vehicle length	L103	3,670 mm	3,770 mm	3,670 mm
Overhang (front)	L104	735 mm		
Overhang (rear)	L105	690 mm		
Upper structure length	L123	2,403 mm	2,503 mm	2,403 mm
Rear wheel C.L. X coordinate	L127	2,800 mm	2,900 mm	2,800 mm
Cowl point X coordinate	L125	904 mm		
Front end length at centerline	L126	1,085 mm		
Rear end length at centerline	L129	183 mm		

Height*

Passenger distribution (front/rear)	PD1:2:1	2/2		
Trunk cargo load		—		
Vehicle height	H101	1,350 mm		
Cowl point to ground	H114	920 mm		
Deck point to ground	H136	—		
Rocker panel (front) to ground	H112	235 mm		
Bottom of door closed (front) to ground	H133	325 mm		
Rocker panel (rear) to ground	H111	255 mm		
Bottom of door closed (rear) to ground	H135	—	328 mm	—
Windshield slope angle	H122	56°30'		
Backlight slope angle	H121	43°50'		

Ground Clearance*

Front bumper to ground	H102	220 mm		190 mm
Rear bumper to ground	H104	235 mm		
Bumper to ground (front) at curb mass wt.	H103	260 mm		
Bumper to ground (rear) at curb mass wt.	H105	305 mm		
Angle of approach (degrees)	H106	20.5		18.5
Angle of departure (degrees)	H107	26.2		
Ramp break-over angle (degrees)	H147	20.0	19.0	20.0
Axle differential to ground (front/rear)	H153	165 mm		
Min. running ground clearance	H156	175 mm		
Location of min. run. gnd. clear.		Pivot of front lower suspension arm		

* All vehicle height and ground clearances are made at the Manufacturer's Design Load Weight unless otherwise specified. Manufacturer's Design Load Weight is defined with indicated passenger distribution and trunk cargo load.
 All linear dimensions are in millimeters (inches) unless otherwise noted.

MVMA Specifications Form
Passenger Car
METRIC (U.S. Customary)
Car and Body Dimensions

Car Line SPRINT
 Model Year 1987 Issued _____ Revised (e) _____

See Key Sheets for definitions

Body Type	SAE Ref. No.	2-DOOR HATCHBACK SEDAN IMR08	4-DOOR HATCHBACK SEDAN IMR68

Front Compartment

Sg RP front "X" coordinate	L31	1,840
Effective head room	H61	940
Max. eff. leg room (accelerators)	L34	1,068
Sg RP to heel point	H30	238
Sg RP to heel point	L53	Right - 832, Left - 867
Back angle	L40	25°
Hip angle	L42	R: 93°, L: 96°
Knee angle	L44	R: 118°, L: 124°
Foot angle	L46	R: 140°, L: 87°
Design H-point front travel	L17	Right - 160, Left - 180
Normal driving & riding seat track travel	L23	Right - 160, Left - 180
Shoulder room	W3	1,280
Hip room	W5	1,275
Upper body opening to ground	H50	1,240
Steering wheel maximum diameter*	W9	375 (Turbo - 380)
Steering wheel angle	H18	27°
Acce. heel pt. to steer. wh. cntr	L11	457
Acce. heel pt. to steer. wh. cntr	H17	620
Steering wheel to C. L. of thigh	H13	85
Steering wheel torso clearance	L7	385
Headlining to roof pane (front)	H37	15
Undepressed floor covering thickness	H67	30

Rear Compartment

Sg RP Point couple distance	L50	670	745
Effective head room	H63	914	923
Min. effective leg room	L51	R: 758, L: 738	R: 827, L: 806
Sg RP (second) to heel	H31	265	
Knee clearance	L48	R: -55, L: -70	R: 13, L: -4
Compartment room	L3	650	725
Shoulder room	W4	1,263	1,277
Hip room	W6	1,034	1,158
Upper body opening to ground	H51	NA	1,240
Back angle	L41	25°	
Hip angle	L43	R: 76°, L: 75°	R: 79.5°, L: 78.5°
Knee angle	L45	R: 67°, L: 64°	R: 77.5°, L: 74.5°
Foot angle	L47	R: 112°, L: 110°	R: 119°, L: 117°
Headlining to roof pane (second)	H38	15	
Depressed floor covering thickness	H73	20	

Luggage Compartment

Usable luggage capacity [cu. ft.]	V1	—
Liftover height	H195	595

Interior Volumes (EPA Classification)

Vehicle class (subcompact, compact, etc.)	Mini-compact	Sub-compact
Interior volume index [cu. ft.]	74.7	79.4
Trunk cargo index [cu. ft.]	8.6	8.8

* See page 14

All linear dimensions are in millimeters (inches) unless otherwise noted

MVMA Specifications Form
Passenger Car
METRIC (U.S. Customary)

Car Line SPRINT
 Model Year 1987 Issued _____ Revised _____

Body Type	2-DOOR HATCHBACK SEDAN 1MR08	4-DOOR HATCHBACK SEDAN 1MR68
-----------	------------------------------------	------------------------------------

Restraint System

Active restraint system	Standard optional	Standard
	Type and description	3 point shoulder and lap belt for driver and front passenger, Lap belt for all other positions
	Location	Front - (2), Rear - (2)
Passive seat belts	Standard optional	Not available
	Power manual	Not applicable
	2 or 3 point	"
	Knee bar / bobble	"

Frame

Type and description (separate frame unitized frame, partially-unitized frame)	Unitized frame
--	----------------

Glass	SAE Ref. No.		
Windshield glass exposed surface area (cm ² in ²)	S1	6,885	
Side glass exposed surface area (cm ² in ²) - total 2-sides	S2	11,490	11,650
Backlight glass exposed surface area (cm ² in ²)	S3	4,830	
Total glass exposed surface area (cm ² in ²)	S4	23,205	23,365
Windshield glass (type)		Curved-laminated plate	
Side glass (type)		Curved-tempered plate	
Backlight glass (type)		"	

MVMA Specifications Form
Passenger Car
METRIC (U.S. Customary)

Car Line SPRINT
 Model Year 1987 Issued _____ Revised (#) _____

Body Type	2-DOOR HATCHBACK SEDAN 1MR08	4-DOOR HATCHBACK SEDAN 1MR68
-----------	------------------------------------	------------------------------------

Convenience Equipment (standard, optional, n.a.)

Air conditioning (manual auto temp control)	Optional (manual control)	
Clock (digital; analog)	Optional, digital, integral with radio	
Compass thermometer	Not available	
Console (floor, overhead)	Optional, floor	
Defroster, elec backing	Optional	
Electronic	Diagnostic monitor (integrated, individual)	Not available
	Instrument cluster (list instruments)	"
	Keyless entry	"
	Indicator (avg. spd, fuel)	"
	Voice alert (list items)	"
Other	"	
Fuel door lock (remote key electric)	Not available	
Lamps	Auto head on/off delay, dimming	"
	Cornering	"
	Courtesy, map reading	"
	Door lock, ignition	"
	Engine compartment	"
	Fog	"
	Glove compartment	"
Trunk	"	
Other	"	
Mirrors	Day/night, auto man.	Standard, manual
	LH remote power heated	Standard, remote
	RH convex remote power heated	Optional, convex
	Visor, LH, RH, LH illuminated	Not available
Parking brake (auto release, warning light)	Manual release, warning light	
Power equipment	Door locks, electric, specify	Not available
	Seat, 1-4-6 way, heated (driver, pass, other), lumbar, mid, high support, power, manual, reclining (driver, pass), memory, 1-2 preset, recline	Not available
	Side windows	"
	Vent windows	"
	Rear window	"
Radio systems	Antenna location, whip w shield power	Whip, front pillar mounted
	AM/FM stereo tape, CE	AM/FM, AM/FM Stereo with/without cassette tape
	Speakers, number, location, Premium sound	Two front std., two rear std. w/ stereo
Roof open air (fixed, fold-down, sliding, etc)	Not available	
Speed control device	"	
Speed warning device (dash, buzzer, etc)	"	
Tachometer (rpm)	Optional	
Telephone system (mobile)	Not available	
Theft protection (type)	Lock mounted on steering column; locks steering wheel and ignition	

MVMA Specifications Form Passenger Car

Model Year 1987 Issue 1987 Revision 1

METRIC (U.S. Customary)

Engine Description/Carb. Engine Code	1.0 LTR L3 (61 CID)	1.0 LTR L3 (61 CID)	1.0 LTR L3 (61 CID)
	2-BBL. CARBURETOR	2-BBL. CARBURETOR	EPI
	RPO LM9	ER	TURBO

Electrical - Supply System

Battery	Manufacturer	Furukawa Battery Co., Ltd.	
	Model, std. (opt.)	55B24R(S) - MF	
	Voltage	12 volt	
	Amps at 0°F cold crank	400	
	Minutes-reserve capacity	70	
	Amp hrs. - 20 hr. rate	45 AH	
Location	L.H. side of engine compartment		
Alternator	Manufacturer	Nippon Denso	
	Rating	(MT): 45A, (AT): 50A	50A
	Ratio (alt. crank/rev.)	2.0 : 1	
	Optional (type & rating)	None	
Regulator	Type	Integral with alternator	

Electrical - Starting System

Start. motor	Current drain at 0°F	200 A Max.
	Engagement type	Positive shift solenoid
Motor drive	Pinion engages from (front, rear)	Front

Electrical - Ignition System

Type	Electronic (std., opt., n.s.)	Not available	Standard	
	Other (specify)	High energy ignition (integral with distributor)		
Coil	Make	Nippon Denso	Diamond Electric	
	Model	029700-5900	E064	
	Current	Engine stopped - A	0	
		Engine idling - A	1.5 Max.	
Spark plug	Make	NGK, ND or AC	NGK or ND	
	Model	BPR6ES-11, W16EXR-U11 or R43CXLS	BPR6ES-11 or W16EXR-U11	
	Thread (mm)	M14 x 1.25		
	Tightening torque (N-m (lb. ft))	20 - 30		
	Gap	1.1, 1.1 and 1.05	1.1 and 1.05	
	Number per cylinder	1		
Distributor	Make	Nippon Denso	Mitsubishi Electric	
	Model	MT - 100291-0251 100291-2050	T004T-73072	

Electrical - Suppression

Locations & type	AT - 100291-0661 MT - 100291-1860 (Canadian version)
	Internal alternator capacitor, resistor high-tension ignition cables, resistor spark plugs, ignition coil by-pass capacitor, flame spraying rotor distributor

MVMA Specifications Form
Passenger Car
METRIC (U.S. Customary)

Car Line SPRINT
 Model Year 1987 Issued _____ Revised (●) _____

Body Type

2-DOOR HATCHBACK SEDAN 1MR08	4-DOOR HATCHBACK SEDAN 1MR68
------------------------------------	------------------------------------

Body

Structure	Unitized frame
Bumper system front - rear	Bumper stays have energy absorption units and bumper member is covered by polypropylene molding skin.
Anti-corrosion treatment	<ol style="list-style-type: none"> 1. Use of surface treatment steel plate in major body components 2. Application of vinyl chloride coating to floor bottom surface 3. Application of tipping coating to side sill outer surface 4. Application of corrosion protection oil to side sill inner surface

Body - Miscellaneous Information

Type of finish (lacquer, enamel, other)	Enamel	
Hood	Hinge location (front, rear)	Rear
	Type (counterbalance, prop)	Prop
	Release control (internal, external)	Internal & external
Trunk lid	Type (counterbalance, other)	Not applicable
	Internal release control (elec., mech., n.a.)	"
Hatch-back lid	Type (counterbalance, other)	2-Telescopic gas strut rods
	Internal release control (elec., mech., n.a.)	Not applicable
Station wagon		"
		"
Vent window control (manual, friction, pivot, power)	Front	None
	Rear	Pivot None
Seat cushion type (e.g., 60-40, bucket, bench, wire, foam, etc.)	Front	Semi-bucket, polyurethane & spring
	Rear	Bench, Polyurethane
	3rd seat	None
Seat back type (e.g., 60-40, bucket, bench, wire, foam, etc.)	Front	Semi-bucket, polyurethane & spring
	Rear	Bench, polyurethane & steel panel
	3rd seat	None

MVMA Specifications Form Passenger Car

Car Line SPRINT
 Model Year 1987 Issued _____ Revised (•) _____

METRIC (U.S. Customary)

Body Type And Or Engine Displacement	2 DOOR HATCHBACK SEDAN 1MR08	4 DOOR HATCHBACK SEDAN 1MR68	2 DOOR HATCHBACK SEDAN TURBO
---	------------------------------------	------------------------------------	------------------------------------

Steering

Manual (std., opt., n.a.)	Standard			
Power (std., opt., n.a.)	Not available			
Adjustable steering wheel column (tilt, telescope, other)	Type	Not applicable		
	Manufacturer	"		
	(Std., opt., n.a.)	Not available		
Wheel diameter** (W9) SAE J110C	Manual	375 mm	380 mm	
	Power	Not available		
Turning diameter* (m (ft.))	Outside front	Wall to wall (l. & r.)	10.0 m 10.4 m	
		Curb to curb (l. & r.)	9.2 m 9.6 m 9.6 m	
	Inside rear	Wall to wall (l. & r.)	Not applicable	
		Curb to curb (l. & r.)	"	
Scrub Radius*	- 2 mm			
Manual	Type	Rack and Pinion		
	Manufacturer	Suzuki Motor		
	Gear Ratios	Gear	Not applicable	
		Overall	18 : 1	
No. wheel turns (stop to stop)	3.5	13.3		
Type (coaxial, linkage, etc.)	-			
Power	Manufacturer	-		
	Type	-		
	Gear Ratios	Gear	Not applicable	
		Overall	-	
		Pump drive	-	
No. wheel turns (stop to stop)	-			
Linkage	Type	End take-off tie rods		
	Location (front or rear of wheels, other)	Rear		
	Tie rods (one or two)	Two		
	Inclination at camber (deg.)	27		
Steering axis	Upper Bearings type	Rubber bush		
	Lower Bearings type	Rubber bush		
	Thrust	Not applicable		
Steering spindle & horn type	Serrated shaft			
Wheel spindle nut	Diameter	Inner bearing	Inner dia. 35 mm, Outer dia. 62 mm	
		Outer bearing	" "	
	Thread size	M8 x 1.25		
	Bearing (type)	Ball bearing		

*The horizontal distance in the front elevation between wheel centerline and kingpin (ball joint) axis at ground

**See Page 2

MVMA Specifications Form
Passenger Car
METRIC (U.S. Customary)

Car Line SPRINT/FIREFLY
 Model Year 1987

Body Type And/Or
 Engine Displacement

1.0 LTR L3 (61CID) 2-BBL. CARBURETOR RPO LM9	1.0 LTR L3 (61CID) 2-BBL. CARBURETOR ER	1.0 LTR L3 (61CID) EPI TURBO
--	---	------------------------------------

Wheel Alignment

Front wheel at curb mass (wt.)	Service checking	Caster (deg.)	3.17
		Camber (deg.)	0.25
		Toe-in (outside track-mm (in.))	-2 ~ 2 mm
	Service reset*	Caster	Not adjustable
		Camber	"
		Toe-in	Adjustable
	Periodic M.V. inspection	Caster	3.17±2°
		Camber	0.25±1°
		Toe-in	-2 ~ 2 mm
Rear wheel at curb mass (wt.)	Service checking	Camber (deg.)	0
		Toe-in (outside track-mm (in.))	0
	Service reset*	Camber	Not adjustable
		Toe-in	"
	Periodic M.V. inspection	Camber	0±1°
		Toe-in	±2 mm

* Indicates pre-set, adjustable, trend set or other.

Electrical - Instruments and Equipment

Speedometer	Type (analog, digital, std., opt.)	Analog
	Trip odometer (std., opt., n.a.)	Standard
EGR maintenance indicator		Not applicable
Charge indicator	Type	Tell-tale warning light
	Warning device (light, audible)	"
Temperature indicator	Type	Electric gauge with pointer
	Warning device (light, audible)	Tell-tale warning light (U.S. version only)
Oil pressure indicator	Type	Tell-tale warning light
	Warning device (light, audible)	"
Fuel indicator	Type	Electric gauge with pointer
	Warning device (light, audible)	"
Wind-shield wiper	Type (standard)	Electric 2-speed
	Type (optional)	Intermittent
	Blade length	425 mm
	Sweep area (cm ² (in. ²))	4,896
Wind-shield washer	Type (standard)	Electric, push-button on instrument panel
	Type (optional)	Not available
	Fluid level indicator (light, audible)	"
Rear window wiper, wiper/washer (std., opt., n.a.)		Optional
Horn	Type	Electric resonator
	Number used	1
Other		Service & parking brake failure warning light, seatbelt warning light and buzzer, headlight high beam indicating light, check engine indicating light, turn signal indicating light, Turbo indicator (Turbo), shift indicator (ER)

MVMA Specifications Form Passenger Car

Car Line SPRINT
 Model Year 1987 Issued _____ Revised (#) _____

METRIC (U.S. Customary)

Body Type And/Or
Engine Displacement

1.0 LTR L3 (61 CID) 2-BBL. CARBURETOR RPO LM9	1.0 LTR L3 (61 CID) 2-BBL. CARBURETOR ER	1.0 LTR L3 (61 CID) EPI TURBO
---	--	-------------------------------------

Brakes - Service

Description		Hydraulic, Front - Floating caliper type Rear - Leading trailing shoe type			
Manufacturer and brake type (std., opt., n.a.)	Front (disc or drum)	Aisin Seiki, Disc			
	Rear (disc or drum)	Nishinbo, Drum			
Self-adjusting (std., opt., n.a.)		Standard			
Special valving	Type (proportion, delay, metering, other)	Proportion			
Power brake (std., opt., n.a.)		Standard			
Booster type (remote, integral, vac. hvd., etc.)		Vacuum			
Vacuum source (inline, pump, etc.)		Inline (intake manifold)			
Vacuum reservoir (volume in. ³)		None			
Vacuum pump-type (elec. gear driven, belt driven, if other so state)		None			
Anti-lock device type (std., opt., n.a.) (F/R)		Not available			
Effective area (cm ² (in. ²))*		136/201			
Gross lining area (cm ² (in. ²))**(F/R)		140/207			
Swept area (cm ² (in. ²))*** (F/R)		861/340			
Rotor	Outerworking diameter	F/R	213/—		
	Inner working diameter	F/R	134/—		
	Thickness	F/R	10		
	Material & type (vented/solid)	F/R	Cast iron, Solid		
Drum	Diameter & width	F/R	—/180 x 30 mm		
	Type and material	F/R	—/Cast iron		
Wheel cylinder bore		F/R	51.1/17.46 mm		
Master cylinder	Bore/stroke	F/R	20.63/28.5 mm		
Pedal arc ratio		4.8 : 1			
Line pressure at 445 N(100 lb.) pedal load (kPa (psi))		—			
Lining clearance		F/R	Self adjusting/Self adjusting		
Brake lining	Front wheel	Bonded or riveted (rivets/seg.)		Bonded	
		Rivet size		Not applicable	
		Manufacturer		Akebono Brake Industry	
		Lining code*****		AK V3512EE	
		Material		Resin mold including metal	
		****	Primary or out-board	103 x 38 x 10 mm	
		Size	Secondary or in-board	104 x 38 x 10 mm	
		Shoe thickness (no lining)		5 mm	
	Rear wheel	Bonded or riveted (rivets/seg.)		Bonded	
		Manufacturer		Nisshin Spinning	
		Lining Code*****		NBK D3216FF	
		Material		Resin mold	
		****	Primary or out-board	173 x 30 x 4 mm	
		Size	Secondary or in-board	173 x 30 x 4 mm	
Shoe thickness (no lining)		1.8 mm			

*Excludes rivet holes, grooves, chamfers, etc.

**Includes rivet holes, grooves, chamfers, etc.

***Total swept area for four brakes. (Drum brake: Widest lining contact width for each brake x its contact circumference.)
(Disc brake: Square of Outer Working Dia. minus Square of inner Working Dia. multiplied by Pi/2 for each brake.)

****Size for drum brakes includes length x width x thickness.

*****Manufacturer I.D., catalog or formulation designation and coefficient of friction classification.

MVMA Specifications Form Passenger Car

Car Line SPRINT
 Model Year 1987 Issued _____ Revised (•) _____

METRIC (U.S. Customary)

Body Type And/Or Engine Displacement	1.0 LTR L3 (61 CID) 2-BBL. CARBURETOR RPO LM9	1.0 LTR L3 (61 CID) 2-BBL. CARBURETOR ER	1.0 LTR L3 (61 CID) EPI TURBO
---	---	--	-------------------------------------

Tires And Wheels (Standard)

Tires	Size (load range, ply)	P145/80R12		P165/70R12	
	Type (bias, radial, etc.)	Radial			
	Inflation pressure (cold) for recommended max. vehicle load	Front (kPa (psi))	220 (32)	240 (35)	180 (26)
		Rear (kPa (psi))	220 (32)	240 (35)	180 (26)
Rev./mile—@: 70 km/h (45 mph)	714		709		
Wheels	Type & material	5° Drop center, steel			
	Rim (size & flange type)	12 x 4.00B		12 x 4.50B	
	Wheel offset	45 mm			
	Attachment	Type (bolt or stud)	Stud		
Circle diameter		114.3 mm			
Number & size		4 - M10			
Spare	Tire and wheel (same, if other describe)	Same			
	Storage position & location (describe)	Flat under rear load floor			

Tires And Wheels (Optional)

Size (load range, ply)	}	
Type (bias, radial, etc.)		
Wheel (type & material)		
Rim (size, flange type and offset)		
Size (load range, ply)		
Type (bias, radial, etc.)		
Wheel (type & material)		Not available
Rim (size, flange type and offset)		
Size (load range, ply)		
Type (bias, radial, etc.)		
Wheel (type & material)		
Rim (size, flange type and offset)		
Size (load range, ply)		
Type (bias, radial, etc.)		
Wheel (type & material)		
Rim (size, flange type and offset)		
Spare tire and wheel		
(if configuration is different than road tire or wheel, describe optional spare tire and/or wheel location & storage position)		

Brakes - Parking

Type of control	Lever - hand operated	
Location of control	Between front seats	
Operates on	Rear service brakes	
If separate from service brakes	Type (internal or external)	Not applicable
	Drum diameter	"
	Lining size (length x width x thickness)	"

MVMA Specifications Form Passenger Car

Car Line SPRINT
 Model Year 1987 Issued _____ Revised (●) _____

METRIC (U.S. Customary)

Engine Description/Carb.
 Engine Code

1.0 LTR L3 (61 CID) 2-BBL. CARBURETOR RPO LM9	1.0 LTR L3 (61 CID) 2-BBL. CARBURETOR ER	1.0 LTR L3 (61 CID) EPI TURBO
---	--	-------------------------------------

Axle Shafts – Front Wheel Drive

Manufacturer and number used		NTN, Two	
Type (straight, solid bar, tubular, etc.)		Left	Solid bar
		Right	Solid bar
Outer diam. x length* x wall thickness	Manual transmission	Left	23 x 445 mm
		Right	23 x 534.5 mm
	Automatic transmission	Left	19.4 x 399.7 mm
		Right	19.4 x 578.6 mm
	Optional transmission	Left	None
		Right	"
Slip yoke	Type		"
	Number of teeth		"
	Spine o.d.		"
Universal joints	Make and mfg. no.	Inner	NTN Toyo Bearing
		Outer	"
	Number used		4
	Type, size, plunge	Inner	Tripod, TJ75
		Outer	Rzeppa, BJ75
	Attach (u-bolt, clamp, etc.)		Serration
Bearing	Type (plain, anti-friction)	Anti-friction	
	Lubrication (fitting, prepack)	Prepack	
Drive taken through (torque tube, arms or springs)		Lower control arm and stabilizer bar, Upper - McPherson stru	
Torque taken through (torque tube, arms or springs)		Engine mounting system	

* Centerline to centerline of universal joints, or to centerline of attachment.

MVMA Specifications Form Passenger Car

METRIC (U.S. Customary)

Car Line SPRINT
 Model Year 1987 Issued _____ Revised (#) _____

Body Type And/Or
 Engine Displacement

1.0 LTR L3 (61 CID) 2-BBL. CARBURETOR RPO LM9	1.0 LTR L3 (61 CID) 2-BBL. CARBURETOR ER	1.0 LTR L3 (61 CID) EPI TURBO
---	--	-------------------------------------

Suspension - General

Car leveling	Std./opt./n.a.	Not available
	Type (air, hyd., etc.)	Not applicable
	Manual/auto. controlled	"
Provision for brake dip control		"
Provision for accel. squat control		"
Provisions for car jacking		Front & rear support locations underneath of body side sill
Shock absorber (front & rear)	Type	Front-McPherson, Rear-direct, double acting hydraulic
	Make	Front-Shock or Kayaba, Rear-Kayaba or Tokico
	Piston diameter	Front - 25 mm, Rear - 20 mm
	Rod diameter	Front - 18 mm, Rear - 10 mm

Suspension - Front

Type and description		McPherson strut with coil springs		
Travel	Full jounce	100 mm		
	Full rebound	50 mm		
Spring	Type (coil, leaf, other) & material	Coil, steel		
	Insulators (type & material)	Rubber		
	Size (coil design height & i.d., bar length x dia.)	(MT) 335 x 90 x 2,445 x 10.2 mm	328.2 x 90 x 2,410 x 10.4 mm	
		(AT) 343.5 x 90 x 2,445 x 10.2 mm		
	Spring rate (N/mm (lb./in.))	16.3	17.9	
Rate at wheel (N/mm (lb./in.))	14.7	16.2		
Stabilizer	Type (link, linkless, frameless)	Linkless		
	Material & bar diameter	Steel, 18 mm	Steel, 22 mm	

Suspension - Rear

Type and description		Torsion beam		
Travel	Full jounce	120 mm		
	Full rebound	50 mm		
Spring	Type (coil, leaf, other) & material	Coil, Steel		
	Size (length x width, coil design height & i.d., bar length & dia.)	4 door 318.5x80.4x2490x9.7	2 door 312.5x80.4x2410x9.6	302.5x80.4x2390x10.
		Spring rate (N/mm (lb./in.))	16.3	17.7
	Rate at wheel (N/mm (lb./in.))	15.7	17.1	
	Insulators (type & material)	Rubber - top only		
	If leaf	No. of leaves	Not applicable	
Shackle (comp. or tens.)		"		
Stabilizer	Type (link, linkless, frameless)	Integral function performed by axle beam		
	Material & bar diameter	Steel tubing, 28.6 mm		
Track bar (type)		Transverse beam design		

MVMA Specifications Form
Passenger Car
METRIC (U.S. Customary)

Car Line SPRINT
 Model Year 1987 Issued _____ Revised (●) _____

Engine Description/Carb. Engine Code	1.0 LTR L3 (61 CID) 2-BBL. CARBURETOR RPO LM9	1.0 LTR L3 (61 CID) 2-BBL. CARBURETOR ER	1.0 LTR L3 (61 CID) EPI TURBO
---	---	--	-------------------------------------

Transmissions/Transaxle

Manual 3-speed (std., opt., n.a.) (mfr.)	Not available
Manual 4-speed (std., opt., n.a.) (mfr.)	"
Manual 5-speed (std., opt., n.a.) (mfr.)	Standrad
Manual overdrve (std., opt., n.a.) (mfr.)	Not available
Automatic (std., opt., n.a.) (mfr.)	Optional Not available
Automatic overdrve (std., opt., n.a.) (mfr.)	Not available

Manual Transmission/Transaxle

Number of forward speeds	5		
Transmission ratios	In first	3.42	
	In second	1.89	
	In third	1.28	
	In fourth	0.91	
	In fifth	0.76	
	In overdrive	—	
	In reverse	2.92	
Synchronous meshing (specify gears)	All forward gears		
Shift lever location	Floor mounted		
Lubricant	Capacity [L (pt.)]	2.3	
	Type recommended	Hypoid gear oil	
	SAE viscosity number	Summer	SAE 75W
		Winter	"
Extreme cold		"	

Clutch (Manual Transmission)

Make, type, engagement (describe) - (hydraulic, cable, rod)	Aisin Seiki, Dry single plate, Cable	Daikin Manufacturing Dry single plate, Cab	
Assist (yes, no / percent)	No		
Type pressure plate springs	Diaphragm		
Total spring load [N (lb.)]	2,550	2,697	
No. of clutch driven discs	1		
Clutch facing	Material	Semi-mold	
	Manufacturer	Aisin Seiki	Daikin Manufacturing
	Part number	22400-82023	22400-82610
	Rivets/plate	—	
	Rivet size	—	
	Outside & inside dia.	160 x 110 mm	190 x 132 mm
	Total eff. area [cm ² (in. ²)]	106	147
	Thickness	3.2 mm	3.5 mm
Engagement cushion method	Separate cushion type		
Release bearing	Type & method of lubrication Automatic center adjusting type with grease lubrication		
Torsional damping	Method: springs, friction material Spring type, Facing: Non asbestos, Friction washer: Asbestos		

MVMA Specifications Form Passenger Car

METRIC (U.S. Customary)

Car Line SPRINT
 Model Year 1987 Issued _____ Revised (●) _____

Engine Description/Carb.
Engine Code

1.0 LTR L3 (61 CID) 2-BBL. CARBURETOR RPO LM9	1.0 LTR L3 (61 CID) 2-BBL. CARBURETOR ER	1.0 LTR L3 (61 CID) EPI TURBO
---	--	-------------------------------------

Automatic Transmission/Transaxle

Trade name		3-speed Automatic
Type and special features (describe)		Torque converter with planetary gears
Selector	Location	Floor mounted on console
	Ltr./No. designation	P-R-N-D-2-L
Gear ratios	1st	2.81 (Equivalent)
	2nd	1.55 (Equivalent)
	3rd	1.00 (Equivalent)
	4th	Not applicable
	Reverse	2.30 (Equivalent)
Max. upshift speed - drive range (km/h (mph))		1 → 2 52 (32.3), 2 → 3 97 (60.3)
Max. kickdown speed - drive range (km/h (mph))		2 → 1 40 (24.9), 3 → 2 88 (54.8)
Min. overdrive speed (km/h (mph))		Not applicable
Torque converter	Number of elements	3
	Max. ratio at stall	2.3 : 1
	Type of cooling (air, liquid)	Liquid
	Nominal diameter	226 mm
Lubricant	Capacity (refill L (pt.))	4.5
	Type Recommended	DEXRON II
Oil cooler (std., opt., NA, internal, external, air, liquid)		Std. integral with radiator

Axle or Front Wheel Drive Unit

Type (front, rear)		Front	
Description		Front differential with helical gears and ball bearings	
Limited slip differential (type)		None	
Drive pinion offset		Not applicable	
Drive pinion (type)		Helical gear	
No. of differential pinions		2	
Pinion / differential adjustment (shim, other)		Shim	
Pinion / differential bearing adjustment (shim, other)		Not applicable	
Driving wheel bearing (type)		Ball bearing	
Lubricant	Capacity (L (pt.))		Not applicable, part of automatic transmission assembly
	Type recommended		Automatic transmission fluid
	SAE viscosity number	Summer	"
		Winter	"
		Extreme cold	"

Axle or Transaxle Ratio and Tooth Combinations (See 'Power Teams' for axle ratio usage.)

Axle ratio (or overall top gear ratio)		Reduction gear 0.98, final gear 3.95
No. of teeth	Pinion	51, 20
	Ring gear or gear	50, 79
Ring gear o.d.		186.98 mm
Transaxle	Transfer gear ratio	—
	Final drive ratio	—

MVMA Specifications Form
Passenger Car
METRIC (U.S. Customary)

Car Line SPRINT
 Model Year 1987 Issued _____ Revised (#) _____

Engine Description/Carb.
 Engine Code

1.0 LTR L3 (61 CID) 2- BBL. CARBURETOR RPO LM9	1.0 LTR L3 (61 CID) 2-BBL. CARBURETOR ER	1.0 LTR L3 (61 CID) EPI TURBO
--	--	-------------------------------------

Vehicle Emission Control

Exhaust Emission Control	Type (air injection, engine modifications, other)		Feedback carb. + 3 way cata. + EGR + Pulse air	EFI + TWC + EGR
	Air Injection	Pump or pulse	Pulse	N/A
		Driven by	---	
		Air distribution (head, manifold, etc.)	---	
		Point of entry	Exhaust manifold port	---
	Exhaust Gas Recirculation	Type (controlled flow, open orifice, other)	Back pressure controlled	Port pressure controlled
		Exhaust source	Manifold	
		Point of exhaust injection (spacer, carburetor, manifold, other)	Manifold	
	Catalytic Converter	Type	Single bed	
		Number of	1	2
Location(s)		Under floor	1st-Exhaust manifold 2nd-Under floor	
Volume (L (in ³))		0.95	0.3(1st), 0.95(2nd)	
Substrate type		Monolith		
Crankcase Emission Control	Type (ventilates to atmosphere, induction system, other)		Induction system	
	Energy source (manifold vacuum, carburetor, other)		Manifold vacuum	
	Discharges (to intake manifold, other)		Intake manifold	
	Air inlet (breather cap, other)		Carburetor air cleaner	Air intake hose
Evaporative Emission Control	Vapor vented to (crankcase, canister, other)	Fuel tank	Canister	
		Carburetor	Canister	N/A
	Vapor storage provision		Canister	
Electronic system	Closed loop (yes/no)		Yes	
	Open loop (yes/no)		Yes	

Engine - Exhaust System

Type (single, single with cross-over, dual, other)		Single	
Muffler no. & type (reverse flow, straight thru, separate resonator) Material & Mass (kg (weight lbs))		One, straight thru	
Resonator no. & type		One, straight thru	
Exhaust pipe	Branch o.d., wall thickness	---	
	Main o.d., wall thickness	48.6 - 1.6 & 38.1 - 1.2 mm	54.0-1.6 & 42.7-1.2mm
	Material & Mass (kg (weight lbs))	Inner: Stainless steel, Outer: Aluminum coated steel	
Intermediate pipe	o.d. & wall thickness	45.0 - 1.6 & 35.0 - 1.2 mm	45.0-1.6 & 41.3-1.2mm
	Material & Mass (kg (weight lbs))	Inner: Stainless steel, Outer: Aluminum coated steel	
Tail pipe	o.d. & wall thickness	35.0 - 1.2 mm	35.0 - 1.2 mm (dual)
	Material & Mass (kg (weight lbs))	Aluminum coated steel	

MVMA Specifications Form

Passenger Car

METRIC (U.S. Customary)

Car Line SPRINT/FIREFLY
 Model Year 1987 Issued _____ Revised (●) _____

Engine Description/Carb.
 Engine Code

1.0 LTR L3 (61 CID)	1.0 LTR L3 (61 CID)
2-BBL. CARBURETOR	EPI
RPO LM9	TURBO

Vehicle Emission Control

Exhaust Emission Control	Type (air reaction, engine modifications, other)		M/T: Engine modifications A/T: EGR	EFI + TWC + EGR
	Air Injection	Pump or pulse	Not applicable	N/A
		Driven by	"	
		Air distribution (head, manifold, etc.)	"	
		Point of entry	"	
	Exhaust Gas Recirculation	Type (controlled flow, open orifice, other)	M/T: Not applicable A/T: Back pressure controlled	Port pressure controlled
		Exhaust source	M/T: Not applicable, A/T: Manifold	
		Point of exhaust injection (spacer, carburetor, manifold, other)	M/T: Not applicable, A/T: Manifold	
	Catalytic Converter	Type	Not applicable	Single bed
		Number of	"	2
		Location(s)	"	1st - Exhaust manifold 2nd - Under floor
		Volume [L (in ³)]	"	0.3 (1st), 0.95 (2nd)
		Substrate type	"	
	Crankcase Emission Control	Type (ventilates to atmosphere, induction system, other)		Induction system
		Energy source (manifold vacuum, carburetor, other)		Manifold vacuum
Discharges (to intake manifold, other)		Intake manifold		
Air inlet (breather cap, other)		Carburetor air cleaner Air intake nose		
Evaporative Emission Control	Vapor vented to (crankcase, canister, other)	Fuel tank	Canister	
		Carburetor	Canister N/A	
	Vapor storage provision		Canister	
Electronic system	Closed loop (yes/no)		No Yes	
	Open loop (yes/no)		Yes Yes	

Engine - Exhaust System

Type (single, single with cross-over, dual, other)		Single
Muffler no. & type (reverse flow, straight thru, separate resonator) Material & Mass [kg (weight lbs)]		One, straight thru
Resonator no. & type		One, straight thru
Exhaust pipe	Branch o.d., wall thickness	—
	Main o.d., wall thickness	48.6 - 1.6 & 38.1 - 1.2 mm 54.0 - 1.6 & 42.7 - 1.2 mm
	Material & Mass [kg (weight lbs)]	Inner: Stainless steel, Outer: Aluminum coated steel
Intermediate pipe	o.d. & wall thickness	45.0 - 1.6 & 35.0 - 1.2 mm 45.0 - 1.6 & 41.3 - 1.2 mm
	Material & Mass [kg (weight lbs)]	Inner: Stainless steel, Outer: Aluminum coated steel
Tail pipe	o.d. & wall thickness	35.0 - 1.2 mm 35.0 - 1.2 mm (dual)
	Material & Mass [kg (weight lbs)]	Aluminum coated steel

MVMA Specifications Form Passenger Car

Car Line SPRINT
 Model Year 1987 Issued _____ Revised (●) _____

METRIC (U.S. Customary)

Engine Description: Carb.
 Engine Code

1.0 LTR L3 (61 CID) 2-BBL. CARBURETOR RPO LM9	1.0 LTR L3 (61 CID) 2-BBL. CARBURETOR ER	1.0 LTR L3 (61 CID) EPI TURBO
---	--	-------------------------------------

Engine - Cooling System

Coolant recovery system (std., opt., n.a.)		Standard	
Coolant fill location (rad., bottle)		Bottle, coolant recovery	
Radiator cap relief valve pressure (kPa (psi))		88.2	
Circulation thermostat	Type (choke, bypass)	Choke	
	Starts to open at °C (°F)	88	82
Water pump	Type (centrifugal, other)	Centrifugal	
	GPM 1000 pump rpm	15 l/min.	
	Number of pumps	1	
	Drive (V-belt, other)	V-belt	
	Bearing type	Ball	
	Impeller material	Steel	
Housing material		Aluminum alloy	
By-pass recirculation (type (inter., ext.))		External	
Cooling system capacity	With heater—L (qt.)	4.3	4.6
	With air cond.—L (qt.)	4.3	4.6
	Opt. equipment (specify—L (qt.))	—	
Water jackets full length of cyl. (yes, no)		Yes	
Water all around cylinder (yes, no)		Yes	
Water jackets open at head face (yes, no)		Yes	
Radiator core	Std., A/C, HD	Std.	
	Type (cross-flow, etc.)	Vertical flow	
	Construction (fin & tube mechanical, braze, etc.)	Fin & tube	
	Material, mass [kg (wgt. lbs.)]	Copper & brass, 1.6	Copper & brass, 2.2
	Width	358 mm	328 mm
	Height	350 mm	325 mm
	Thickness	16 mm	32 mm
Fins per inch		10 (Manual), 11.3 (Automatic)	8
Radiator end tank material		Plastic	Brass
Fan	Std., elec., opt.	Std. Elec.	
	Number of blades & type (flex, solid, material)	4, Solid, Plastic	
	Diameter & projected width	300 mm	
	Ratio (fan to crankshaft rev.)	—	
	Fan cutout type	—	
	Drive type (direct, remote)	Electric Motor Drive	
	RPM at idle (elec.)	2,100	
	Motor rating (wattage) (elec.)	80	
	Motor switch (type & location) (elec.)	Wax type, on thermostat cap	
	Switch point (temp., pressure) (elec.)	Temp., 96°C - ON, 91°C - OFF Temp., 91°C - ON, 86°C - OFF	
Fan shroud (material)		Steel	

MVMA Specifications Form Passenger Car

METRIC (U.S. Customary)

Car Line SPRINT FIREFLY
 Model Year 1987 Issued _____ Registered _____

Engine Description/Carb. Engine Code	1.0 LTR L3 (61 CID) 2-BBL. CARBURETOR RPO LM9	1.0 LTR L3 (61 CID) 2-BBL. CARBURETOR ER	1.0 LTR L3 (61 CID) EPI TURBO
---	---	--	-------------------------------------

Engine - Fuel System (See supplemental page for details of Fuel Injection, Supercharger, Turbocharger, etc. if used)

Induction type: carburetor, fuel injection system, etc.	Carburetor	Fuel injection	
Manufacturer	U.S.-Hitachi, Canada-Aisan		
Carburetor	Choke (type)	Full auto wax type	
	Idle spd.-rpm (spec. neutral or drive and propane if used)	Manual	750 Neutral
		Automatic	850 Neutral
Idle A/F mix.	Preset - no adjustment provided		
Fuel injection	Point of injection (no.)	—	
	Constant pulse flow	—	
	Control (electronic, mech.)	—	
	System pressure (kPa (psi))	—	
Intake manifold heat control (exhaust or water thermostatic or fixed)	Water (coolants)	N/A	
Air cleaner type	Standard	Replaceable paper element, single snorkel	
	Options	—	
Fuel pump	Type (elec. or mech.)	Mechanical	
	Location (eng., tank)	Engine	
	Pressure range (kPa (psi))	29	

Fuel Tank

Capacity (refill L (gallons))	33 (8.7)	
Location (describe)	Under-floor-rear	
Attachment	Bolt	
Material & Mass (kg (weight lbs))	Steel, 7.0 kg	
Filler pipe	Location & material	Left side rear quarter panel, Steel
	Connection to tank	Rubber hose
Fuel line (material)	Steel	
Fuel hose (material)	Rubber	
Return line (material)	Steel	
Vapor line (material)	Steel	
Extended range tank	Opt., n.a.	Not available
	Capacity (L (gallons))	Not applicable
	Location & material	"
	Attachment	"
Auxiliary tank	Opt., n.a.	Not available
	Capacity (L (gallons))	Not applicable
	Location & material	"
	Attachment	"
	Selector switch or valve	"
	Separate fill	"

MVMA Specifications Form Passenger Car

Car Line SPRINT
Model Year 1987 Issue: _____ Rev. _____

METRIC (U.S. Customary)

Engine Description/Carb.
Engine Code

1.0 LTR L3 (61 CID) 2-BBL. CARBURETOR RPO LM9	1.0 LTR L3 (61 CID) 2-BBL. CARBURETOR ER	1.0 LTR L3 (61 CID) EPI TURBO
---	--	-------------------------------------

ENGINE - GENERAL

Type & description (inline, V, angle, flat, location, front, mid, rear, transverse, longitudinal, sohc, dohc, ohv, hemi, wedge, pre-camber, etc.)	Inline, Front SOHC Transverse, front of engine faces right side of vehicle		
Manufacturer	Suzuki		
No. of cylinders	3		
Bore	74 mm		
Stroke	77 mm		
Bore spacing (C/L to C/L)	84 mm		
Cylinder block material & mass kg (lbs.) (machined)	Aluminum alloy, 11.85		
Cylinder block deck height	186.8 mm		
Cylinder block length	288 mm		
Deck clearance (minimum) (above or below block)			
Cylinder head material & mass kg (lbs.)	Aluminum alloy, 0.55		
Cylinder head volume (cm ³)	32.2		36.0
Cylinder liner material	Cast iron		
Head gasket thickness (compressed)	1.2 mm		
Minimum combustion chamber total volume (cm ³)	38.96	37.61	45.45
Cyl. no. system (front to rear)*	L Bank	1-2-3	
	R Bank	-	
Firing order	1-3-2		
Intake manifold material & mass (kg (lbs.))**	Aluminum alloy, 1.74		Aluminum alloy, 1.89
Exhaust manifold material & mass (kg (lbs.))**	Cast iron, 2.64		Cast iron, 1.75
Recommended fuel (leaded, unleaded, diesel)	Unleaded		
Fuel antiknock index (R + M) 2	87		
Total dressed engine mass (wt) dry***	67kg (M/T), 60kg (A/T) 66 kg		78 kg

Engine - Pistons

Material & mass, g (weight, oz.) - piston on	Aluminum alloy, 217	Aluminum alloy, 232
--	---------------------	---------------------

Engine - Camshaft

Location	In cylinder head	
Material & mass kg (weight, lbs.)	Cast iron, 1.51	
Drive type	Chain/belt	Belt
	Width/pitch	19.1/9.53 mm

* Rear of engine - drive takeoff. View from drive takeoff end to determine left & right side of engine.

** Finished state.

*** Dressed engine mass (weight) includes the following:

All those items necessary to make the engine a complete ready-to-run unit.

MVMA Specifications Form
Passenger Car
METRIC (U.S. Customary)

Car Line SPRINT
 Model Year 1987 Issued _____ Revised (☉) _____

Engine Description/Carb.
 Engine Code

1.0 LTR L3 (61 CID) 2-BBL. CARBURETOR RPO LM9	1.0 LTR L3 (61 CID) 2-BBL. CARBURETOR ER	1.0 LTR L3 (61 CID) EPI TURBO
---	--	-------------------------------------

Engine - Valve System

Hydraulic lifters (std., opt., NA)	NA	
Valves	Number intake / exhaust	3/3
	Head O.D. intake / exhaust	36.0/30.0 mm

Engine - Connecting Rods

Material & mass (kg., (weight, lbs.))*	Forged steel, 0.415	Forged steel, 0.360	Forged steel, 0.455
--	---------------------	---------------------	---------------------

Engine - Crankshaft

Material & mass (kg., (weight, lbs.))*	Nodular iron, 6.666	Nodular iron, 5.900	Nodular iron, 6.666
End thrust taken by bearing (no.)	2		
Number of main bearings	4		
Seal (material, one, two piece design, etc.)	Front	One	
	Rear	One	

Engine - Lubrication System

Normal oil pressure (kPa (psi) at engine rpm)	333 @4,000	392 @4,000
Type oil intake (floating, stationary)	Stationary	
Oil filter system (full flow, part, other)	Full flow	
Capacity of c/case, less filter-refill-L (qt.)	3.5	

Engine - Diesel Information

Diesel engine manufacturer	} Not applicable	
Glow plug, current drain at 0°F		
Injector nozzle		Type
		Opening pressure (kPa (psi))
Pre-chamber design		
Fuel injection pump		Manufacturer
		Type
Fuel injection pump drive (belt, chain, gear)		
Supplementary vacuum source (type)		
Fuel heater (yes/no)		
Water separator, description (std., opt.)		
Turbo manufacturer		
Oil cooler-type (oil to engine coolant; oil to ambient air)		
Oil filter		

Engine - Intake System

Turbo charger - manufacturer	Not applicable	I.H.I.
Super charger - manufacturer	"	
Charge cooler	"	Toyo Radiator

*Finished State

I.H.I. - ISHIKAWAJIMA HARIMA

Model Specifications Form
Passenger Car

Model Year 1987 Issued _____ Revised _____

METRIC (U.S. Customary)

Power Teams (Indicate whether standard or optional)
SAE J1349 Net bhp (brake horsepower) and net torque corrected to 77°F/25° C and 29.61 in. Hg/100 kPa atmospheric pressure

SERIES AVAILABILITY	ENGINE					E x h a u s t S/D	TRANSMISSION TRANSAXLE	AXLE RATIO (std. first)
	Displ. Liters (in ³)	Carb. (Barrels, Fl. etc.)	Compr. Ratio	SAE Net at RPM				
				Power (bhp)	Torque N·m (lb. ft.)			
SPRINT Base - All States	L-3 1.0 L (61)	2-Bbl Carb.	9.5:1	48 HP	77	S	Man. 5-speed (3.42 Low) - Base	4.10
				@ 5,100	@ 3,200		Auto. 3-speed Avail.	
SPRINT ER except High Altitude	L-3 1.0 L (61)	2-Bbl Carb.	9.8:1	46 HP @ 4,700	78 @ 3,200	S	Man. 5-speed (3.42 Low) - Base	3.79
TURBO SPRINT	L-3 1.0 L (61)	*EPI	8.3:1	70 HP @ 5,500	107 @ 3,500	S	Man. 5-speed (3.42 Low) - Base	4.10
* - Electronic Fuel Injection								

MVMA Specifications Form
Passenger Car

Model: SPRINT/FIREFLY
Model Year: 1987

METRIC (U.S. Customary)

Power Teams (Indicate whether standard or optional)
SAE J1349 Net bhp (brake horsepower) and net torque corrected to 77°F/25° C and 29.61 in. Hg/100 kPa atmospheric pressure.

SERIES AVAILABILITY	ENGINE					E x h a u s t S/D	TRANSMISSION/ TRANSAXLE	AXLE RATIO (std. first)
	Displ. Liters (in ³)	Carb. (Barrels, Fl. etc.)	Compr. Ratio	SAE Net at RPM				
				Power (bhp)	Torque N·m (lb. ft.)			
SPRINT/FIREFLY Base - All States	L-3 1.0 L (61)	2-Bbl Carb.	9.5:1	48 HP @ 5,100	77 @ 3,200	S	Man. 5-speed (3.42 Low) - Base	4.10
							Auto. 3-speed Avail.	3.87 (Equivalent)
TURBO SPRINT -TURBO FIREFLY	L-3 1.0 L (61)	*EPI	8.3:1	70 HP @ 5,500	107 @ 3,500	S	Man. 5-speed (3.42 Low) - Base	4.10
* - Electronic Fuel Injection								

MVMA Specifications Form
Passenger Car
METRIC (U.S. Customary)

Car Line SPRINT
 Model Year 1987 Issued _____ Revised (e) _____

Car Models

Model Description & Drive (FWD/RWD)	Introduction Date	Make Car Line Series, Body Type (Mfr's Model Code)	No. of Designated Seating Positions (Front/Rear)	Max. Trunk Cargo Load—Kilograms (Pounds)
FRONT WHEEL DRIVE				
		MODEL NUMBER	FRONT/REAR	
SPRINT 2-Door Hatchback Sedan		1MR08	2/2	40 (88)
4-Door Hatchback Sedan		1MR68	2/2	40 (88)
SPRINT ER 2-Door Hatchback Sedan		1MS08	2/2	40 (88)
TURBO SPRINT 2-Door Hatchback Sedan		1MR08	2/2	40 (88)

MVMA Specifications Form
Passenger Car
METRIC (U.S. Customary)

Car Line SPRINT/FIREFLY
 Model Year 1987 Issued

Car Models

Mode Description & Drive (FWD/RWD)	Introduction Date	Make, Car Line, Series, Body Type (Mfr's Model Code)	No. of Design Seating Positi (Front/Rear)
FRONT WHEEL DRIVE			
MODEL NUMBER			
FRONT/RE.			
SPRINT 2-Door Hatchback Sedan		1MR08	2/2
4-Door Hatchback Sedan		1MR68	2/2
FIREFLY 2-Door Hatchback Sedan		7MR08	2/2
4-Door Hatchback Sedan		7MR68	2/2
TURBO SPRINT 2-Door Hatchback Sedan		1MR08	2/2
TURBO FIREFLY 2-Door Hatchback Sedan		7MR08	2/2

**MVMA Specifications Form
Passenger Car**

Car Line _____
Model Year _____ Issued _____ Revised (•) _____

**METRIC (U.S. Customary)
SUPPLEMENTAL PAGE**



MVMA Specifications Form Passenger Car

METRIC (U.S. Customary)

Interior Car And Body Dimensions - Key Sheet Dimensions Definitions

- W203 REAR OPENING WIDTH AT FLOOR. The minimum dimension measured laterally between the limiting interferences of the rear opening at floor level.
- W204 REAR OPENING WIDTH AT BELT. The minimum dimension measured laterally between the limiting interferences of the rear opening at belt height or top of pick up box.
- W205 REAR OPENING WIDTH ABOVE BELT. The minimum dimension measured laterally between the limiting interferences of the rear opening above the belt height.
- H197 FRONT SEATBACK TO LOAD FLOOR HEIGHT. The dimension measured vertically from the horizontal tangent to the top of the seatback to the undepressed floor covering.
- H201 CARGO HEIGHT. The dimension measured vertically from the top of the undepressed floor covering to the headlining at the rear wheel "X" coordinate on the zero "Y" plane.
- H202 REAR OPENING HEIGHT. The dimension measured vertically from the top of the undepressed floor covering to the upper trimmed opening on the zero "Y" plane with rear door fully open.
- H250 TAILGATE TO GROUND CURB MASS (WT.). The dimension measured vertically from the top of the undepressed floor covering on the lowered tailgate to ground on the zero "Y" plane.
- V2 STATION WAGON
Measured in inches:
$$\frac{W4 \times H201 \times L204}{1728} = \text{ft}^3$$

Measured in mm:
$$\frac{W4 \times H201 \times L204}{10^9} = \text{m}^3 \text{ (cubic meter)}$$
- V4 HIDDEN LUGGAGE CAPACITY-REAR OF FRONT SEAT. The total volumes of individual pieces of one set of standard luggage stowed in any hidden cargo area below the load floor rear of the front seat.
- V5 TRUCKS AND MPV'S WITH OPEN AREA.
Measured in inches:
$$\frac{L506 \times W500 \times H503}{1728} = \text{ft}^3$$

Measured in mm:
$$\frac{L506 \times W500 \times H503}{10^9} = \text{m}^3 \text{ (cubic meter)}$$
- V6 TRUCKS AND MPV'S WITH CLOSED AREA.
Measured in inches:
$$\frac{L204 \times W500 \times H505}{1728} = \text{ft}^3$$

Measured in mm:
$$\frac{L204 \times W500 \times H505}{10^9} = \text{m}^3 \text{ (cubic meter)}$$
- V8 HIDDEN LUGGAGE CAPACITY-REAR OF SECOND SEAT. The total volume of individual pieces of one set of standard luggage stowed in any hidden cargo area below the load floor rear of the second seat.
- V10 STATION WAGON CARGO VOLUME INDEX.
Measured in inches:
$$\frac{H201 \times L205 \times \frac{W4 + W201}{2}}{1728} = \text{ft}^3$$

Measured in mm:
$$\frac{H201 \times L205 \times \frac{W4 + W201}{2}}{10^9} = \text{m}^3 \text{ (cubic meter)}$$

Hatchback - Cargo Space Dimensions

All hatchback cargo dimensions are to be taken with the front seat in full down and rear position, and the rear seat folded down. The hatchback door is in the closed position. (For electrically adjusted seats, see the manufacturer's specifications for Design "H" Point).

- L208 CARGO LENGTH AT FRONT SEATBACK HEIGHT. The minimum horizontal dimension from the "X" plane tangent to the rearmost surface of the driver's seatback to the inside limiting interference of the hatchback door on the vehicle zero "Y" plane.
- L209 CARGO LENGTH AT FLOOR-FRONT-HATCHBACK. The minimum horizontal dimension measured at floor level from the rear of the front seatback to the normal limiting interference of the hatchback door on the vehicle zero "Y" plane.
- L210 CARGO LENGTH AT SECOND SEATBACK HEIGHT-HATCHBACK. The minimum dimension measured from the "X" plane tangent to the rearmost surface of second seatback or the load floor which is stowed at least one half of the H198 dimension height above the rear load floor, to the rearmost inside limiting interference on the zero "Y" plane.
- L211 CARGO LENGTH AT FLOOR-SECOND HATCHBACK. The minimum horizontal dimension measured at floor level from the rear of the second seatback or load floor panel to the normal limiting interference of the hatchback door on the vehicle zero "Y" plane.
- H197 FRONT SEATBACK TO LOAD HEIGHT. The dimension measured vertically from the horizontal tangent to the top of the seatback to the undepressed floor covering.
- H198 SECOND SEATBACK TO LOAD FLOOR HEIGHT: The dimension measured vertically from the second seat back to the undepressed floor covering.
- V3 HATCHBACK.
Measured in inches:
$$\frac{L208 + L209}{2} \times W4 \times H197 = \text{ft}^3$$

Measured in mm:
$$\frac{L208 + L209}{2} \times W4 \times H197 = \text{m}^3 \text{ (cubic meter)}$$
- V4 HIDDEN LUGGAGE CAPACITY-REAR OF FRONT SEAT. The total volumes of individual pieces of one set of standard luggage stowed in any hidden cargo area below the load floor rear of the front seat.
- V11 HATCHBACK CARGO VOLUME INDEX. Usable luggage (one (1) stand and luggage set) below floor:
Measured in inches:
$$\frac{L210 + L211}{2} \times W4 \times H198 = \text{ft}^3$$

Measured in mm:
$$\frac{L210 + L211}{2} \times W4 \times H198 = \text{m}^3 \text{ (cubic meter)}$$

MVMA Specifications Form

Passenger Car

METRIC (U.S. Customary)

Index

Subject	Page No.
Aerodynamics	22
Alternator	16
Automatic Transmission/Transaxle	8, 9
Axis, Steering	14
Axle, Drive, Front, Rear	2, 9, 10
Axle Shafts	10
Battery	16
Body and Miscellaneous Information	17
Brakes—Parking, Service	12, 13
Camber	15
Camshaft	3
Capacities	
Cooling System	5
Fuel Tank	6
Lubricants	
Engine Crankcase	4
Transmission/Transaxle	8, 9
Rear Axle	10
Car Models	1
Car and Body Dimensions	
Width	20
Length	20
Height	20
Ground Clearance	20
Front Compartment	21
Rear Compartment	21
Luggage Compartment	21
Station Wagon - Third Seat	22
Station Wagon - Cargo Space	22
Hatchback - Cargo Space	22
Carburetor	2, 6
Caster	15
Choke, Automatic	6
Clutch - Pedal Operated	8
Coil, Ignition	16
Connecting Rods	4
Convenience Equipment	19
Cooling System	5
Crankshaft	4
Cylinders and Cylinder Head	3
Diesel Information	4
Dimension Definitions	
Key Sheet - Exterior	27, 30, 31
Key Sheet - Interior	28, 29, 31, 32, 33
Electrical System	15, 16
Emission Controls	7
Engine—General	
Bore, Stroke, Type	3
Compression Ratio	2
Displacement	2, 3
Firing Order, Cylinder Numbering	3
General Information, Power & Torque	2
Intake System	4
Power Teams	2
Exhaust System	7
Equipment Availability, Convenience	19
Fan, Cooling	5
Fiducial Marks	23
Filters - Engine Oil, Fuel System	4
Frame	17
Front Suspension	11
Front Wheel Drive Unit	10
Fuel System	6
Fuel Injection	6
Fuel Tank	6
Glass	18
Headroom - Body	21, 22
Heights - Car and Body	20
Horns	15
Horsepower - Brake	2
Ignition System	16
Initiation - Tires	13
Interior Volumes	21
Instruments	15

Subject	Page No.
Lamps and Headlamp Shape	24
Legroom	21, 22
Lengths - Car and Body	20
Leveling, Suspension	11
Lifters, Valve	4
Linings - Clutch, Brake	8, 12
Lubrication - Engine Transmission/Transaxle	4, 8, 9
Luggage Compartment	21
Mass	25, 26
Models	1
Motor Starting	16
Muffler	7
Passenger Capacity	1
Passenger Mass Distribution	25
Pistons	3
Power Brakes	12
Power, Engine	2
Power Steering	14
Power Teams	2
Propeller Shaft, Universal Joints	10
Pumps - Fuel	6
Water	5
Radiator - Cap, Hoses, Core	5
Ratios - Axle, Transaxle	2, 9
Compression	2
Steering	14
Transmission/Transaxle	2, 8, 9
Rear Axle	2, 9, 10
Regulator - Alternator	16
Restraint System	18
Rims	13
Rods - Connecting	4
Scrub Radius	14
Seats	17
Shock Absorbers, Front & Rear	11
Spark Plugs	16
Speedometer	15
Springs - Front & Rear Suspension	11
Stabilizer (Sway Bar) - Front & Rear	11
Starting System	16
Steering	14
Suppression - Ignition, Radio	16
Suspension - Front & Rear	11
Tail Pipe	7
Theft Protection	19
Thermostat, Cooling	5
Tires	13
Toe-In	15
Torque Converter	9
Torque - Engine	2, 8, 9
Transaxle	9
Transmission - Types	2, 8, 9
Transmission - Automatic	2, 8, 9
Transmission - Manual	2, 8, 9
Transmission - Ratios	2, 9
Tread	20
Trunk Cargo Load	2
Trunk Luggage Capacity	2
Turning Diameter	14
Unitized Construction	17
Universal Joints, Propeller Shaft	10
Valve System	4
Voltage Regulator	16
Water Pump	16
Weights	25, 26
Wheel Alignment	11
Wheelbase	2
Wheels & Tires	13
Wheel Spindle	1
Widths - Car and Body	2
Windshield	1
Windshield Wiper and Washer	1