

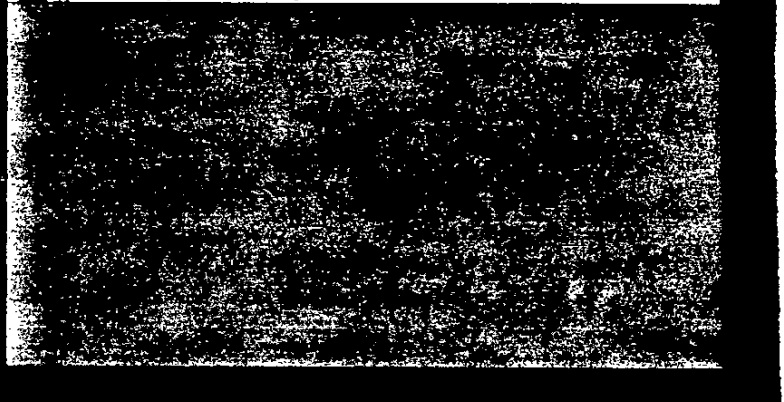

SUBURBAN

1987 -- ORIGINAL



SUBURBAN



EXTERIOR

- All paint colors and placements are carryover for 1987.
- New "Fuel Injection" nameplate is located on the LH side of the LH door on models with panel doors; on the LH side of the tailgate on models with endgate.
- The use of windshield and rear quarter window reveal moldings with bright bead in Scottsdale and Silverado models has been discontinued.

BODY

- Seat-back angle and carefully designed bench seat cushion result in comfortable seating positions.
- Wet-arm windshield wiper/washer system provides good spray of the fluid and cleaning of the windshield.
- Large fuse block provides good serviceability.

CHASSIS AND POWER TEAM

- Note: For 1987, all gasoline engines in these models will be

certified using light-duty emissions test procedure. This will require the use of a catalytic converter and unleaded fuel.

All gasoline engines have Electronic Fuel Injection (EFI).

The advantages are:

- Improved fuel control for enhanced cold starting
- Reduced plug fouling
- Improved fuel economy
- Improved drivability under all operating conditions
- Greater reliability through the use of fewer parts
- No external adjustments.

THE RPO LO3 5.0 LITER (305 CU. IN.) V8 EFI ENGINE

is now available nationwide, as well as California, and is now available in ½-ton Suburbans. HP and torque are increased by about 6%.

THE 5.7 LITER (350 CU. IN.) V8 EFI ENGINE,

RPO LO5, is now available nationwide in ½- and ¾-ton Suburbans. Horsepower increases about 18% and torque about 4%.

THE 7.4 LITER (454 CU. IN.) V8 EFI ENGINE,

RPO L19, continues with the same availability and power ratings.

A 6.2 Liter V8 Diesel engine, RPO LM6, is available on 10 series with Federal Emissions System. The HD emissions engine, RPO LL4, is available on 20 series in all states.

New Delco Freedom battery which is lighter in weight and features a "flat top" case pro-

vides higher cold-cranking amps for all engines except the 6.2 Liter Diesel. The increases are:

Engine	Cold-Cranking Amps	
	1986	1987
5.0 & 5.7 Liter V8	405	525
7.4 Liter V8	540	630
H.D. Battery, RPO UA1	540	630

Delco generator capacities have been increased for all gas engine applications. The base capacity increases from 37 amps to 66 amps. Suburban models equipped with either rear air conditioning, RPO C69, or a combination of auxiliary heater, RPO C36, and rear defogger, RPO C49, have a 78-amp unit with diesel engines or a 105-amp unit with gas engines.

OPTIONS

- Deluxe Front Appearance option, RPO V22, standard on Silverado. Highlights include dual rectangular headlamps and grille with body-color paintfill treatment.
- Custom Vinyl and Custom Cloth seat fabric available for upper trim levels.
- All optional 15" highway-tread steel-belted radial tires will feature all-season tread.
- Front tow hooks available on all models.
- Cast aluminum wheels for improved appearance. Includes four 15" x 7" cast aluminum wheels and center hub covers, RPO N90.
- Power door locks available for panel rear doors.

STANDARD VALUE FEATURES

ALL THIS AT NO EXTRA COST:

- Front stabilizer bar for better roadability standard on R20, all 4-wheel-drive and diesel models.
- Electronic Fuel Injection for better drivability.
- Fade-resistant front disc brakes with audible lining wear sensors.
- Power steering.
- More room than regular station wagons offer. Seats up to nine with available seating.
- Able to carry bigger loads (cargo and people) because under it all is a tough truck chassis.
- Over 60% more load space than the largest full-size car-type station wagon. Approximately 167 cubic feet of inside luggage space when second seat is folded down and available third seat is not installed.
- Contemporary styling makes Suburban a versatile passenger/cargo-carrying vehicle. An ideal travel wagon that's excellent for trailer towing.
- Suburban does most anything a station wagon can, and many things a station wagon can't.
- All-season-tread-design steel-belted radial tires for superb traction, long tread life.
- Self-adjusting hydraulic clutch control for smooth operation with manual transmission.

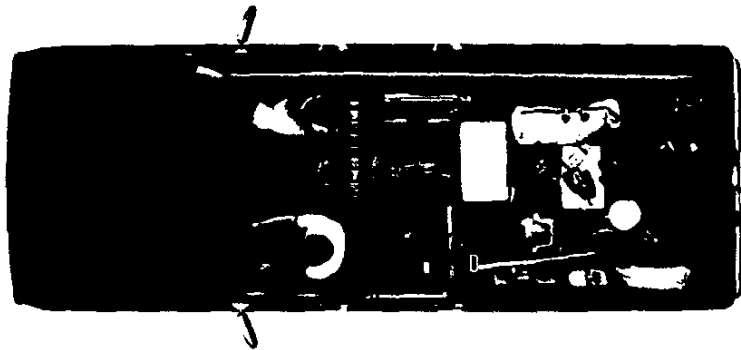

- Bright metal roof drip moldings direct water away from door openings.
- Chrome front and rear bumpers.
- Bright metal hubcaps.
- Full-depth foam front bench seat in vinyl.
- Tinted glass in all windows, standard, deep-tinted glass available.
- Four side doors for easy accessibility to passenger and cargo area.
- Two rear panel doors standard.
- Wagon-type tailgate available with manually retractable window glass.
- Large fuse block for good serviceability.
- Wet-arm windshield wiper/washer system provides precise fluid spray and efficient coverage.
- Anti-chip coating along lower sides.
- Impressive anti-corrosion protection.
- Electric tailgate window available.
- Reclining bucket seats with center console available.

CHASSIS VALUE FEATURES

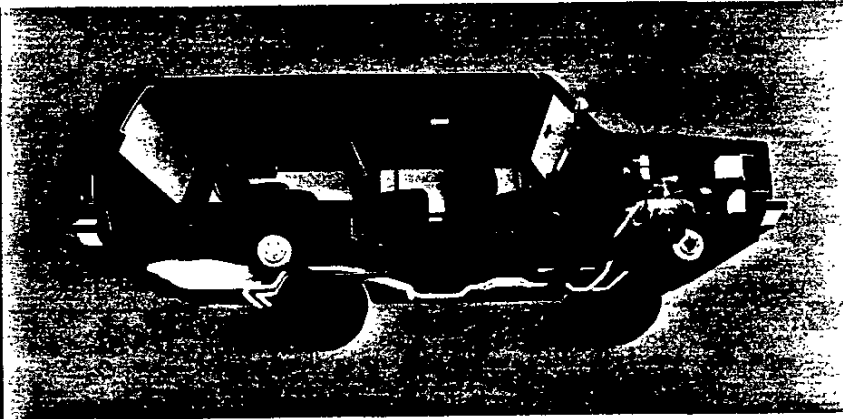

TOUGH TRUCK FRAME AND SUSPENSION

- Rugged girder beam independent front suspension, with coil springs on 2-wheel-drive models, provides a smooth ride.
- Two-stage, multileaf rear springs automatically adjust for heavier loads.
- Rubber-bushed spring eye shackles to reduce noise and ride harshness.

4-WHEEL-DRIVE MODELS

- Includes two-speed transfer case, leaf-type front suspension and front stabilizer bar with hypoid front driving axle.

FRONT DISC BRAKES STANDARD

- Durable and self-adjusting.
- Resist fade, recover quickly from water immersion.
- Shielded for dust protection.
- Lining wear sensors on front disc brakes audibly signal when pads should be replaced.
- Semi-metallic lining material.

FINNED REAR BRAKE DRUMS

- For efficient cooling.
- Outer edges formed to help exclude contaminants.

STAGGERED REAR SHOCKS

- Positioned with one slanting forward, the other aft.
- Reduces brake and power hop.

SALISBURY REAR AXLE

- Tapered roller bearings.
- Broad ratio coverage.
- Semi-floating design for most models.
- 6,000-lb. capacity on Series 20 models.

GVW RATINGS

- 6,100 to 8,600 lbs.

TOWING

- Tows up to 9,500 lbs. when properly equipped. Various optional equipment available including fuel tank with up to 40-gallon capacity.

ANTI-CORROSION MEASURES IN CRITICAL AREAS

- Galvanized metal used on the floor panels, side door inner panels, hood inner panel, side door frames, front fender inner panels and spare tire well.
- Zincrometal[®] used on outer hood panel, outer front fenders and door panels, rear quarter panels and rear doors.

- Protective coatings are used for inner surfaces of door inner rocker panels, front part of hood panels, front fender panels and outer front surfaces of radiator support.

- Precoated steel (with primer baked on one side) used for outer panels and door frames, side outer panels, floor panel front cross sills, windshield frame and cowl panel assembly. Galvanized steel used for side door inner panels and venti-panels, radiator grille lower filler panel and jack stowage retainer. Radiator support lower reinforcement and radiator grille upper panel are made of zinc-iron alloy steel.

- Use of Zincroterne[®] coating on brake pipes.
- Anti-chip coating on lower body side surfaces.
- Zincroterne coating on power steering hydraulic pressure lines.
- Body and sheet metal are primed, with the Suburban steel body, doors and tailgate totally immersed in electrically charged primer, drawing paint into hidden seams and crevices for added corrosion protection.
- After the finish paint is applied and baked on, aluminum wax preservative is sprayed inside the cowl chamber, the door rocker panels and the lower portion of the doors and fenders.

BODY VALUE FEATURES

SEATS UP TO NINE FACING FORWARD

- Full-width front seat standard.
- Folding second seat available.
- Third seat is available with second seat and includes quick-release feature for easy removal.

SPLIT DESIGN OF SECOND SEAT lets either section fold independently for access to available third seat, or to handle long loads.

WITH BOTH SECTIONS FOLDED DOWN, Suburban presents a large, flat, unobstructed load area that's over 8 feet long.

SUBURBAN'S LOAD SPACE between back of third seat and tailgate is 40 cubic feet.

- With available third seat removed, there's 103 cubic feet of load space.
- With second seat folded down and third seat removed, Suburban has 165 cubic feet of carrying capacity.

EVEN WITH AVAILABLE THIRD SEAT IN PLACE, Suburban has plenty of space left for cargo.

CARGO BARRIER IS PROVIDED by Suburban's second seat in the folded position; it helps protect the lower front seat-back from impact damage.

FRONT BUCKET SEATS

- Reclining front bucket seats with outboard armrest and center console available. (See illustration on page 6A.)

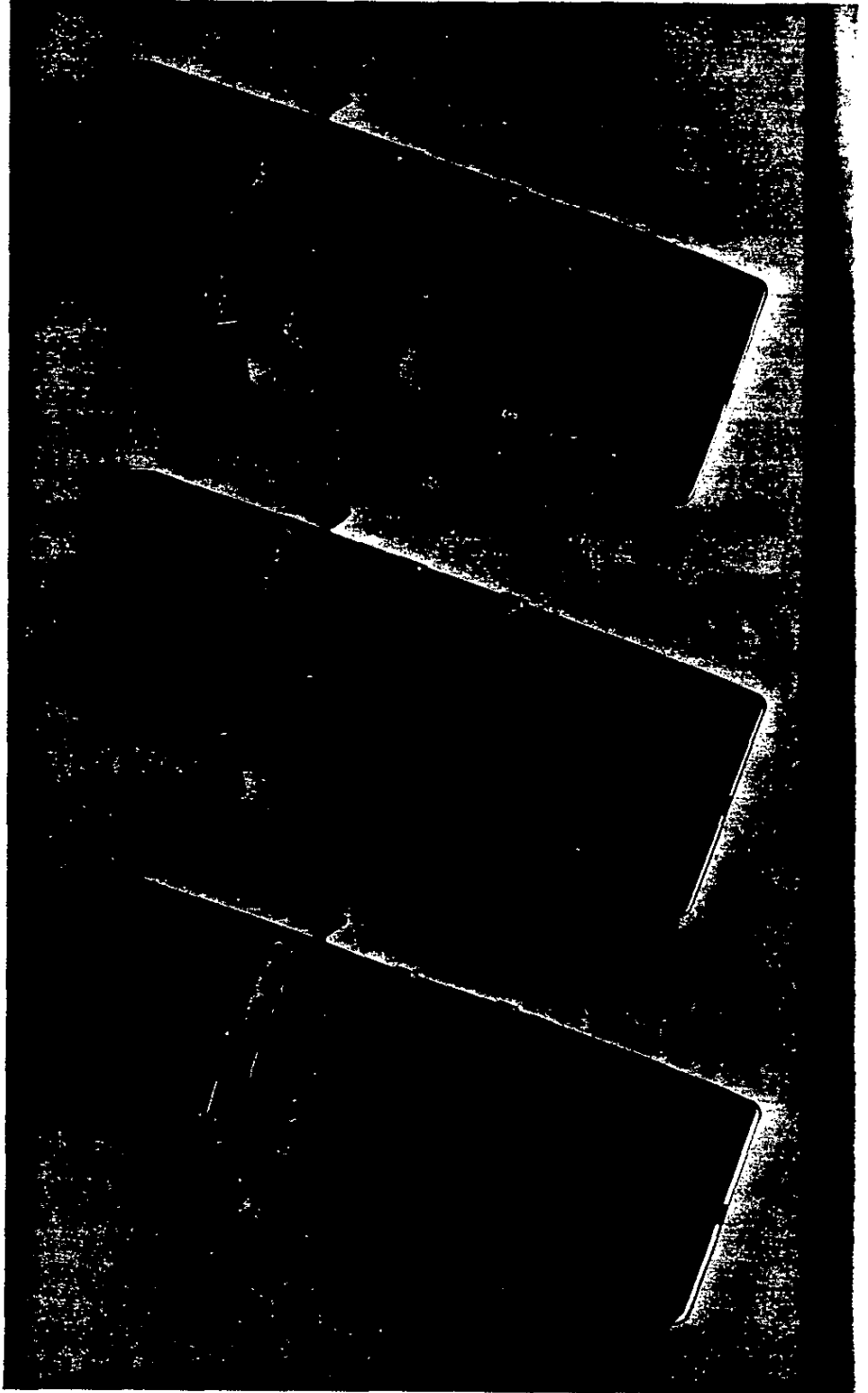

SCOTTSDALE/SILVERADO TRIM OPTION

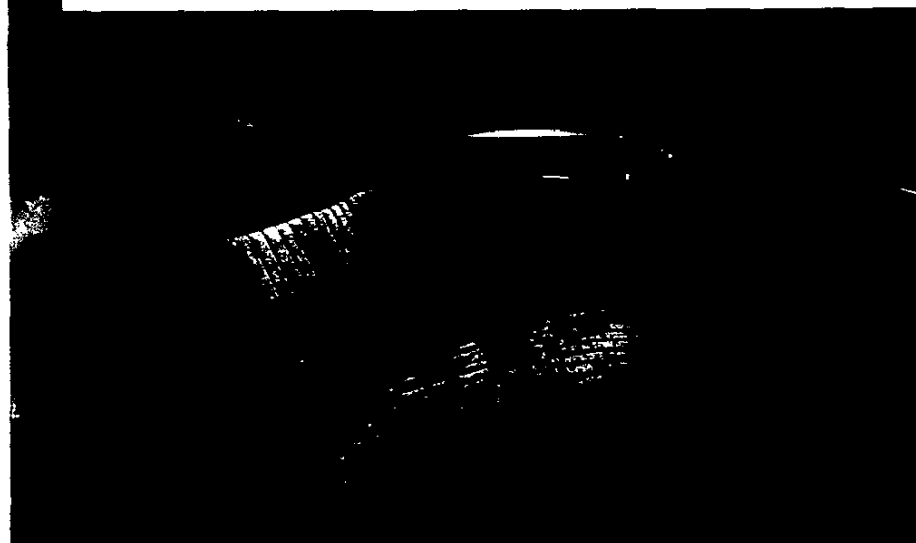

The Scottsdale option is available in vinyl bench seat, Custom Vinyl bench seat and Custom Cloth bench seat. Colors: Blue and Saddle Tan.

The Silverado option is available in Custom Vinyl bench seat (Blue, Burgundy, Saddle Tan), Custom Cloth bench seat (Blue, Burgundy, Saddle Tan, Slate Gray), Custom Vinyl reclining bucket (Blue, Saddle Tan) and Custom Cloth reclining bucket (Blue, Saddle Tan, Slate Gray). See pages D and E for complete details on other trim features of the Scottsdale and Silverado options.

R/V SUBURBAN

SUBURBAN MODEL SELECTOR

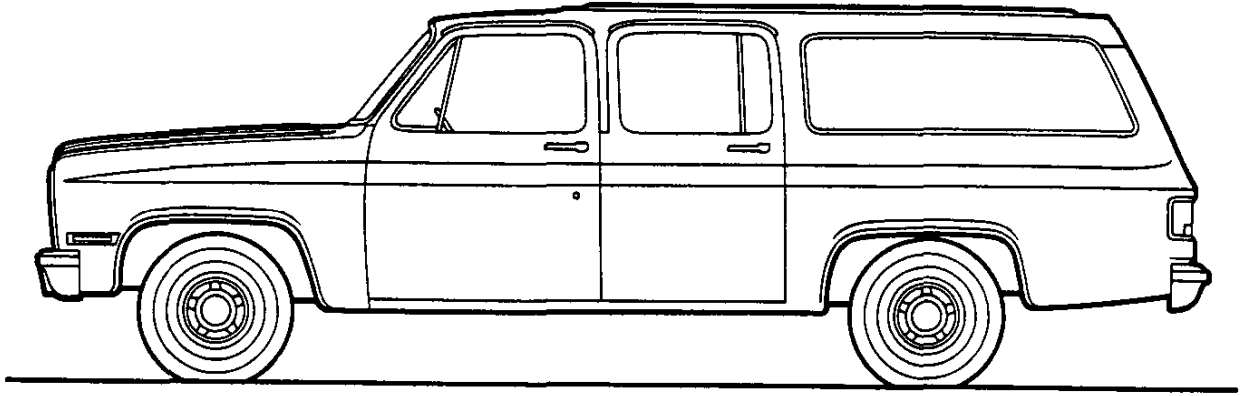

SERIES	MODEL NUMBER	BODY ORDERING CODE			
		GASOLINE MODELS		DIESEL MODELS	
		PANEL REAR DOORS	TAILGATE	PANEL REAR DOORS	TAILGATE
R10/1500	R10906	ZW9	E55	ZW9/B3J	E55/B3J
R20/2500	R20906	ZW9	E55	ZW9/B3J	E55/B3J
V10/1500 (4X4)	V10906	ZW9	E55	ZW9/B3J	E55/B3J
V20/2500 (4X4)	V20906	ZW9	E55	ZW9/B3J	E55/B3J

GASOLINE

R/V SUBURBAN — 2-Wheel Drive

STANDARD SPECIFICATIONS

(See Gray Tab Section for Specification Details)

Series	R10/1500	R20/2500
Engine		
Base Equip.	■5.0 Liter, 305 EFI V8	5.7 Liter, 350 EFI V8
Clutch	—	12," 150 sq. in.
Air Filter	Oiled-paper Element	
Oil Filter	Throwaway Type	
Exhaust System	*Single; Aluminized	**Single; Stainless Steel
Emission Control Systems	See Engine & Cooling Section for specific model applications	
Suspension, Front	Independent; Coil Springs	
Capacity	3250 lb.	3800 lb.
Springs @ Ground	1625 lb. ea.	1900 lb. ea.
Shock Absorbers	25mm dia.	32mm dia.
Stabilizer Bar	—	1.06" dia.
Suspension, Rear	Salisbury Axle; Hypoid Drive; Two-stage Multi-leaf Springs	
Axle Capacity	4000 lb.	6000 lb.
Axle Ratio	3.08	3.42
Springs @ Ground	2000 lb. ea.	3000 lb. ea.
Shock Absorbers	25mm dia.	32mm dia.
Brakes	Hydraulic; Self-adjusting	
Front	Disc; 11.86" Rotor	Disc; 12.5" Rotor
Rear	Drum; 11.15" x 2.75"	Drum; 13.0" x 2.5"
Booster	Dual Diaphragm	
Parking	Cable to Rear Wheels	
Electrical	12 Volt; Negative Ground	
Battery — Freedom Type	425 CCA♦ @ 0°F.	
— Reserve Capacity	90 min. @ 80°F.	
Delcotron Generator	66 amp.	
Frame	Carbon Steel; 36,39,000 psi	
Section Modulus	3.10	3.88
Fuel Tank (nominal capacity)	25 gal.	
Steering Gear Type	Manual; Recirculating Ball Gear	
Linkage	Parallelogram	
Transmission	4-Speed Automatic w/Overdrive	4-Speed Manual (SM 465)
Shift Location	Steering Column	Floor
Tires	(5) P235/75R15 All Seasons Steel Belted Radial	Fr. (2) LT235/85R16D (8PR) Rr. (2) LT235/85R16E (10PR)
Wheels	(5) Disc 15" x 6"	(4) Disc 16" x 6.5"

■Standard engine not available for registration in the State of California; see Power Teams chart.

*Dual tail pipe

**Single; Aluminized for California

♦CCA-Cold Cranking Amps

R/V SUBURBAN—2-Wheel Drive

DIESEL

STANDARD SPECIFICATIONS

(See Gray Tab Section for Specification Details)

Series	★R10/1500	R20/2500
Engine	6.2 Liter, 379 Cu. In. V8 Diesel	
Base Equip.	Poly-wrapped, Oiled-paper Element	
Air Filter	Throwaway Type	
Oil Filter	Standard	
Oil Cooler	Dual; Aluminized	
Exhaust System		
Emission Control Systems	See Engine & Cooling Section for specific model applications	
Suspension, Front	Independent; Coil Springs	
Capacity	3400 lb.	3800 lb.
Springs @ Ground	1700 lb. ea.	1900 lb. ea.
Shock Absorbers	25mm dia.	32mm dia.
Stabilizer Bar	1.06" dia.	
Suspension, Rear	Salisbury Axle; Hypoid Drive; Two-stage Multi-leaf Springs	
Axle Capacity	4000 lb.	6000 lb.
Axle Ratio	3.08	3.73
Springs @ Ground	2000 lb. ea.	3000 lb. ea.
Shock Absorbers	25mm dia.	32mm dia.
Brakes	Hydraulic; Self-adjusting	
Front	Disc; 11.86" Rotor	Disc; 12.5" Rotor
Rear	Drum; 11.15" x 2.75"	Drum; 13.0" x 2.5"
Booster	Hydraulic Power	
Parking	Cable to Rear Wheels	
Electrical	12 Volt; Negative Ground	
Battery—Freedom Type	Two; 540 CCA♦ ea. @ 0°F.	
—Reserve Capacity	115 min. ea. @ 80°F.	
Delcotron Generator	66 amp.	
Engine Block Heater	600 watts, 120 volts	
Frame	Carbon Steel; 36-39,000 psi	
Section Modulus	3.10	3.88
Fuel Tank (nominal capacity)	27 gal.	
Steering Gear Type	Integral Power	
Transmission	4-Speed Automatic w/Overdrive	3-Speed Automatic
Shift Location	Steering Column	
Tires	(5) P235/75R15 XL All Seasons Steel Belted Radial	Fr. (2) LT235/85R16D (8PR) Rr. (2) LT235/85R16E (10PR)
Wheels	(5) Disc 15" x 6"	(4) Disc 16" x 6.5"

★ Not available for registration in State of California

♦ CCA-Cold Cranking Amps

GASOLINE**R/V SUBURBAN—4-Wheel Drive****STANDARD SPECIFICATIONS**

(See Gray Tab Section for Specification Details)

Series	V10/1500	V20/2500
Engine	5.7 Liter, 350 EFI V8 12"; 150 sq. in.	
Base Equip.	Oiled-paper Element	
Clutch	Throwaway Type	
Air Filter	*Single; Aluminized	**Single; Stainless Steel
Oil Filter	See Engine & Cooling Section for specific model applications	
Exhaust System		
Emission Control Systems		
Suspension, Front	Salisbury Axle, Hypoid Drive; Single-stage 2-leaf Springs	
Capacity	3600 lb.	3800 lb.
Axle Ratio	3.42	3.42
Springs @ Ground	1850 lb. ea.	1850 lb. ea.
Shock Absorbers	25mm dia.	32mm dia.
Stabilizer Bar	1.25" dia.	1.25" dia.
Hubs, Manual Locking	Standard	Standard
Suspension, Rear	Salisbury Axle, Hypoid Drive; Two-stage Multi-leaf Springs	
Axle Capacity	4000 lb.	6000 lb.
Axle Ratio	3.42	3.42
Springs @ Ground	2000 lb. ea.	3000 lb. ea.
Shock Absorbers	25mm dia.	32mm dia.
Brakes	Hydraulic; Self-adjusting	
Front	Disc; 11.86" Rotor	Disc; 12.5" Rotor
Rear	Drum; 11.15" x 2.75"	Drum; 13" x 2.5"
Booster	Dual Diaphragm	
Parking	Cable to Rear Wheels	
Electrical	12 Volt; Negative Ground	
Battery—Freedom Type	525 CCA♦ @ 0°F.	
—Reserve Capacity	90 min. @ 80°F.	
Delcotron Generator	66 amp.	
Frame	Carbon Steel; 36,-39,000 psi	
Section Modulus	3.57	3.88
Fuel Tank (nominal capacity)	25 gal.	
Steering Gear Type	Integral Power	
Transmission	4-Speed Manual (SM 465)	
Shift Location	Floor	
Transfer Case	New Process 208 2-Speed	
Shift Lever	Single Lever	
Tires	(5) P215/75R15 All Seasons Steel Belted Radial	Fr. (2) LT235/85R16D (8PR) Rr. (2) LT235/85R16E (10PR)
Wheels	(5) Disc 15" x 6"	(4) Disc 16" x 6.5"

*Dual tail pipe on V10/1500 model.

**Single, Aluminized for California.

♦CCA-Cold Cranking Amps.

R/V SUBURBAN—4-Wheel Drive

DIESEL

STANDARD SPECIFICATIONS

(See Gray Tab Section for Specification Details)

Series	★V10/1500	V20/2500
Engine	6.2 Liter, 379 Cu. In. V8 Diesel	
Base Equip.	Poly-wrapped, Oiled-paper Element	
Air Filter	Throwaway Type	
Oil Filter	Standard	
Oil Cooler	Dual; Aluminized	
Exhaust System	See Engine & Cooling Section for specific model applications	
Emission Control Systems		
Suspension, Front	Salisbury Axle, Hypoid Drive; Single-stage 2-leaf Springs	
Capacity	3600 lb.	3800 lb.
Axle Ratio	3.42	3.73
Springs @ Ground	1850 lb. ea.	1850 lb. ea.
Shock Absorbers	25mm dia.	32mm dia.
Stabilizer Bar	1.25" dia.	1.25" dia.
Hubs, Manual Locking	Standard	Standard
Suspension, Rear	Salisbury Axle, Hypoid Drive; Two-stage Multi-leaf Springs	
Axle Capacity	4000 lb.	6000 lb.
Axle Ratio	3.42	3.73
Springs @ Ground	2000 lb. ea.	3000 lb. ea.
Shock Absorbers	25mm dia.	32mm dia.
Brakes	Hydraulic; Self-adjusting	
Front	Disc; 11.86" Rotor	Disc; 12.5" Rotor
Rear	Drum; 11.15" x 2.75"	Drum; 13" x 2.5"
Booster	Hydraulic Power	
Parking	Cable to Rear Wheels	
Electrical	12 Volt; Negative Ground	
Battery—Freedom Type	Two; 540 CCA ♦ ea. @ 0° F.	
—Reserve Capacity	115 min. ea. @ 80° F.	
Delcotron Generator	66 amp.	
Engine Block Heater	600 watts, 120 volts	
Frame	Carbon Steel; 36,-39,000 psi	
Section Modulus	3.57	3.88
Fuel Tank (nominal capacity)	27 gal.	
Steering Gear Type	Integral Power	
Transmission	4-Speed Automatic w/Overdrive	3-Speed Automatic
Shift Location	Steering Column	
Transfer Case	New Process 208 2-Speed	
Shift Lever	Single Lever	
Tires	(5) P235/75R15 All Seasons Steel Belted Radial	Fr. (2) LT235/85R16D (8PR) Rr. (2) LT235/85R16E (10PR)
Wheels	(5) Disc 15" x 6"	(4) Disc 16" x 6.5"

★ Not available for registration in State of California

♦ CCA-Cold Cranking Amps

GASOLINE

R/V SUBURBAN

Body Ordering Codes:
Panel Rear Doors—ZW9
Endgate—E55†

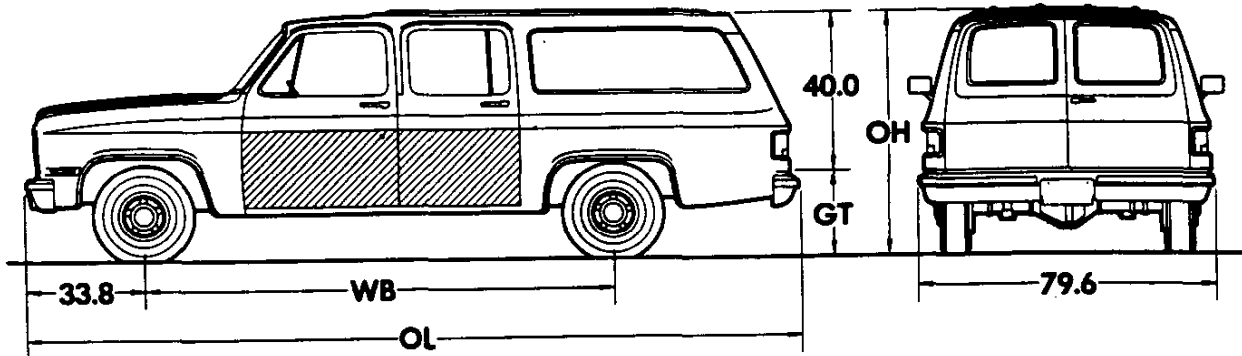

Capacity—165 cu ft
Load Floor Area—40 sq ft

Sign Panel Area (side)
22" x 72 1/4"

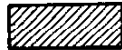

Series	Ground Clearance (in)*	
	Front	Rear
R1	6.6	6.7
R2	8.5	8.5
V1	6.9	7.1
V2	8.6	8.6

Model	Engine No. Cyl.	Dimensions (in)*				†Curb Weight (lb)			†Model Weight (lb)*		
		WB	OL	OH	GT	Front	Rear	Total	Front	Rear	Total
R10/1500 SERIES											
R10906	8	129.5	219.1	72.0	29.0	2112	2170	4284	2355	2379	4734
R20/2500 SERIES											
R20906	8	129.5	219.1	74.3	31.7	2323	2396	4719	2566	2603	5169
V10/1500 SERIES											
V10906	8	129.5	219.1	73.8	30.1	2460	2208	4668	2703	2415	5118
V20/2500 SERIES											
V20906	8	129.5	219.1	76.1	33.6	2578	2449	5027	2821	2656	5477

*Dimensions with standard equipment, unloaded.

*Model Weight includes Curb Weight plus occupants (standard seating capacity x 150 lb). Total Model Weight may vary as much as ± 50 lbs. to allow for production build variation.

†Curb Weights and Model Weights shown are for models with ZW9 Panel Rear Doors. For models with E55 Endgate, weights must be adjusted as follows: Front -2 lb.; Rear +41 lb.; Total added weight 39 lb.

R/V SUBURBAN

DIESEL

Body Ordering Codes:
Panel Rear Doors—ZW9/B3J
Endgate—E55/B3J†

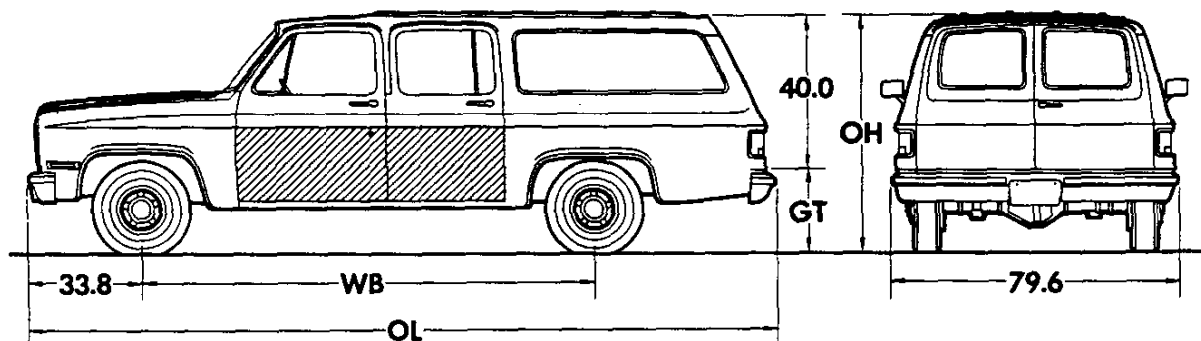

Capacity—165 cu ft
Load Floor Area—40 sq ft

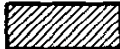
Sign Panel Area (side)
 22" x 72¼" 

Series	Ground Clearance (in)*	
	Front	Rear
R1	6.6	6.7
R2	8.5	8.5
V1	6.9	7.1
V2	8.6	8.6

Model	Engine No. Cyl.	Dimensions (in)*				†Curb Weight (lb)			†Model Weight (lb)*		
		WB	OL	OH	GT	Front	Rear	Total	Front	Rear	Total
R10/1500 SERIES											
R10906	8	129.5	219.1	72.0	29.0	2466	2248	4714	2709	2455	5164
R20/2500 SERIES											
R20906	8	129.5	219.1	74.3	31.7	2665	2511	5176	2908	2718	5626
V10/1500 SERIES											
V10906	8	129.5	219.1	73.8	30.1	2764	2312	5076	3007	2519	5526
V20/2500 SERIES											
V20906	8	129.5	219.1	76.1	33.6	2935	2557	5492	3178	2764	5942

*Dimensions with standard equipment, unloaded.

*Model Weight includes Curb Weight plus occupants (standard seating capacity x 150 lb). Total Model Weight may vary as much as ±50 lbs. to allow for production build variation.

†Curb Weights and Model Weights shown are for models with ZW9 Panel Rear Doors. For models with E55 Endgate, weights must be adjusted as follows: Front -2 lb.; Rear +41 lb.; Total added weight 39 lb.

R/V SUBURBAN

POWER TEAMS

ALL STATES EXCEPT CALIFORNIA

POWER TEAMS (MUST ORDER ENGINE, TRANSMISSION AND REAR AXLE)
 (Consult GVWR Selector and Tire Chart to insure tire capacity and availability)

ENGINE	TRANSMISSION		AXLES				GVWR
	4-SP	AUTO	2.73	3.08	3.42	3.73	
W/NA5 STANDARD EMISSION EQUIPMENT							
-R10906							
L03 V8 5.0 Liter (305 Cu In)-EFI		MXO	—	GQ1	GU6	—	61/6800
L05 V8 5.7 Liter (350 Cu In)-EFI		MXO	GQ1	GU4	—	#GT4	6100
		MXO	—	GQ1	GU6	#GT4	6800
LH6 Diesel 6.2 Liter V8 (379 Cu In)(Reqs B3J)		MXO	—	GQ1	GU6	#GT4	7000
-V10906							
L05 V8 5.7 Liter (350 Cu In)-EFI	MM4		—	—	GQ1	GT4	61/7000
		MXO	—	—	GQ1	#GT4	61/7000
LH6 Diesel 6.2 Liter V8 (379 Cu In)(Reqs B3J)		MXO	—	—	GQ1	GT4	70/7300
W/NA6 HIGH ALTITUDE EMISSION EQUIPMENT							
-R10906							
L03 V8 5.0 Liter (305 Cu In)-EFI		MXO	—	GQ1	GU6	—	61/6800
L05 V8 5.7 Liter (350 Cu In)-EFI		MXO	—	GQ1	GU6	GT4	61/6800
LH6 Diesel 6.2 Liter V8 (379 Cu In)(Reqs B3J)		MXO	—	—	GQ1	GT4	7000
-V10906							
L05 V8 5.7 Liter (350 Cu In)-EFI	MM4		—	—	GQ1	GT4	61/7000
		MXO	—	—	GQ1	GT4	61/7000
LH6 Diesel 6.2 Liter V8 (379 Cu In)(Reqs B3J)		MXO	—	—	GQ1	GT4	70/7300

#Reqs Z82 Trailering Special

CALIFORNIA ONLY

POWER TEAMS (MUST ORDER ENGINE, TRANSMISSION AND REAR AXLE)
 (Consult GVWR Selector and Tire Chart to insure tire capacity and availability)

ENGINE	TRANSMISSION		AXLES				GVWR
	4-SP	AUTO	2.73	3.08	3.42	3.73	
W/YF5 CALIFORNIA EMISSION REQUIREMENTS							
-R10906							
L03 V8 5.0 Liter (305 Cu In)-EFI		MXO	—	GQ1	GU6	—	61/6800
L05 V8 5.7 Liter (350 Cu In)-EFI		MXO	—	GQ1	GU6	—	61/6800
-V10906							
L05 V8 5.7 Liter (350 Cu In)-EFI		MXO	—	—	GQ1	GT4	61/7000

#Reqs Z82 Trailering Special

R/V SUBURBAN

POWER TEAMS

ALL STATES

POWER TEAMS (MUST ORDER ENGINE, TRANSMISSION AND REAR AXLE)

(Consult GVWR Selector and Tire Chart to insure tire capacity and availability)

W/NA5 STANDARD Satisfies High Altitude Emission Requirements), **NA6 HIGH ALTITUDE** ■ OR **YF5 CALIFORNIA EMISSION**

ENGINE	TRANSMISSION						GVWR
	4-SP	AUTO	3.42	3.73	4.10	4.56	
-R20906							
§§L05 V8 5.7 Liter (350 Cu In)-EFI	MM4		GQ1	GT4	GT5	—	8600
		MX1	—	GQ1	GT5	HC4	8600
§§L19 V8 7.4 Liter (454 Cu In)-EFI (Reqs N41 and UA1)		MX1	GQ1	GT4	GT5	—	8600
LL4 Diesel 6.2 Liter V8 (379 Cu In)(Reqs B3J)		MX1	—	GQ1	GT5	HC4	8600
-V20906							
§§L05 V8 5.7 Liter (350 Cu In)-EFI	MM4		GQ1	GT4	GT5	—	8600
		MX1	—	GQ1	GT5	—	8600
LL4 Diesel 6.2 Liter V8 (379 Cu In)(Reqs B3J)		MX1	—	GQ1	GT5	—	8600

§§N/A NA6 High Altitude Emissions. With NA5 Emissions Satisfies High Altitude Requirements

■ High Altitude Emission Equipment (FOR EXHAUST SMOKE REDUCTION PURPOSES AT HIGH ALTITUDE; NOT REQUIRED TO SATISFY HIGH ALTITUDE REGULATIONS)(REQS LL4 ENG)

ENGINE RATINGS

ALL STATES

SAE Net Ratings	*5.0 Liter 305 EFI V8	*5.7 Liter 350 EFI V8	**5.7 Liter 350 EFI V8
Net Horsepower	170 @ 4000 rpm	210 @ 4000 rpm	†195 @ 4000 rpm
Net Torque, lb-ft	255 @ 2400 rpm	300 @ 2800 rpm	†300 @ 2800 rpm

SAE Net Ratings	**7.4 Liter 454 EFI V8	*6.2 Liter 379 V8 Diesel	**6.2 Liter 379 V8 Diesel
Net Horsepower	230 @ 3600	130 @ 3600 rpm	148 @ 3600 rpm
Net Torque, lb-ft	385 @ 1600	240 @ 2000 rpm	246 @ 2000 rpm

*Series 10/1500 models.

**Series 20/2500 models.

†For California models only: HP—185 @ 4000 rpm. Torque—295 @ 2400 rpm.

R/V SUBURBAN

GVWR SELECTOR—ALL STATES

GVW Rating (lbs)	†GAWR (lbs)		Minimum Equipment Required for GVW Rating		
	Front	Rear	Tire Capacity (lbs ea)		Chassis Equipment
			Front	Rear	

R10/1500 SERIES

▲#6100	3250	3686	1843	1843	Standard
▲#6800	3250	3968	1984	1984	Stabilizer Bar (F59)
◆7000	3400	3968	1984	1984	Standard

V10/1500 SERIES

▲#6100	3166	3166	1583	1583	Standard
●#7000	3600	3686	1843	1843	
◆7300	3600	3968	1984	1984	Center and Rear Seats (AS3)

†GAWR's shown are the maximum for each axle with equipment listed. Other GAWR's are available, and they are determined as the minimum capacity of either axle, springs or tires.

▲Not available on diesel engine models.

●On diesel engine models, not available with Center and Rear Seats (AS3).

■Center seat (AT5) available on all GVWRs; Center and Rear seats (AS3) available on 6800 or above GVWRs.

◆Available on diesel engine models only.

FRONT AND REAR TIRE AVAILABILITY CHART—ALL STATES

R-V10/1500 SERIES

**Spare tire to match either front or rear tires must be ordered.
V10/1500 models require matching front and rear tread**

Description	Capacity (lbs ea)	Highway		On-Off Road		Spare
		Front	Rear	*Front	Rear	
TUBELESS						
#P215/75R15 Steel Belted Radial	1583	XCU	YCU	—	—	ZCU
#P215/75R15 Whitewall Steel Belted Radial	1583	XCV	YCV	—	—	ZCV
P235/75R15 Steel Belted Radial	1843	XFL —	YFL —	*XES	YES	ZFL ZES
P235/75R15 Whitewall Steel Belted Radial	1843	XFM	YFM	—	—	ZFM
P235/75R15 XL Steel Belted Radial	1984	XHA	YHA	—	—	ZHA
P235/75R15 Whitewall XL Steel Belted Radial	1984	XHB	YHB	—	—	ZHB

*On-Off road front tires available on V1 models only.

#V1 models only. Not available on Diesel Equipment models.

R/V SUBURBAN

GVWR SELECTOR—ALL STATES

GVW Rating (lbs)	†GAWR (lbs)		Minimum Equipment Required for GVW Rating		
	Front	Rear	Tire Capacity (lbs ea)		Chassis Equipment
			Front	Rear	

R20/2500 SERIES

8600	3800	6000	2623	3042	Standard
------	------	------	------	------	----------

V20/2500 SERIES

8600	3700	6000	2623	3042	Standard
------	------	------	------	------	----------

†GAWR's shown are the maximum for each axle with equipment listed. Other GAWR's are available, and they are determined as the minimum capacity of either axle, springs or tires.

FRONT AND REAR TIRE AVAILABILITY CHART—ALL STATES

R-V20/2500 SERIES

Spare tire to match either front or rear tires is available at extra cost.
V20/2500 models require matching front and rear tread

Description	Capacity (lbs ea)	Highway		On-Off Road		Spare
		Front	Rear	★Front	Rear	
TUBELESS						
LT235/85R16D Steel Belted Radial	2623	XYM	—	—	—	—
LT235/85R16E Steel Belted Radial	3042	—	YYN	—	—	ZYN
		—	—	—	#YYT	#ZYT
		—	—	—	#YYT	#ZYN
LT235/85R16E Steel Belted Radial	3042	XYN	YYN	—	—	ZYN
		—	—	★XYT	YYT	ZYT
		—	—	—	#YYT	#ZYN

★On-Off road front tires available on V2 models only.
#Available on R2 models only.

R/V SUBURBAN

THE FOLLOWING EQUIPMENT IS STANDARD ON DIESEL ENGINE MODELS (ALSO SEE STANDARD SPECIFICATIONS PAGES)

- Low Coolant Sensor
- Poly-wrapped Paper Element Air Cleaner
- Auxiliary Engine Oil Cooler provided with 4.56 ratio rear axle (in addition to cooler in radiator tank)
- Power Steering
- Engine Block Heater (600 watts, 120 volts)
- Water/fuel separator unit which incorporates a water sensor and sending unit, a fuel filter, a fuel heater and water drain capability
- Hydraulic Power-assisted Brakes
- 66-amp Generator
- Engine Oil Cooler (located in radiator tank)
- Dual 540 Cold Cranking Amp/115 min. Reserve Capacity Batteries
- HD Radiator
- Dual Exhaust System
- Additional Insulation:
 - Cab-to-fender insulators
 - Fiberglass hood insulator
 - Fiberglass engine compartment firewall insulator
 - Cowl side spray-on deadener
 - Driver compartment dash mat with increased mastic layer
 - Resinated cotton and mastic floor insulation
 - Full cowl interior trim panels with resinated cotton insulation
 - Full-length, foam-backed cloth headliner
- Warning Lights: Glow Plugs, Water-in-fuel (or fuel filter), and Low Coolant
- Diesel Engine Identification:
 - Hood ornament
 - Fender nameplates
 - Rear door or tailgate nameplate
 - "Diesel Fuel Only" filler cap and label

R-V SUBURBAN

1987 VEHICLES WITH STANDARD EQUIPMENT

Prices shown are effective with initial shipments of 1987 model motor vehicles

Description	Model Number	Body Code	Wheel Base	Factory D&H(a)	List Price	Mfr's Suggested Retail Price*	Group Number
◆ 8-Cylinder 5.0 Liter (305 Cu. In.) E.F.I. V8 Gasoline Engine-Engine Ordering Code L03							
R10 Series 2-Wheel Drive							
Panel Doors	CR10906	ZW9	129.5"	N.A.	12435.00	12435.00	16
Tailgate	CR10906	E55	129.5"	N.A.	12477.00	12477.00	16
◆ 8-Cylinder 5.7 Liter (350 Cu. In.) E.F.I. V8 Gasoline Engine-Engine Ordering Code L05							
V10 Series 4-Wheel Drive							
Panel Doors	CV10906	ZW9	129.5"	N.A.	13512.00	13512.00	16
Tailgate	CV10906	E55	129.5"	N.A.	13553.00	13553.00	16
R20 Series 2-Wheel Drive							
Panel Doors	CR20906	ZW9	129.5"	3.78	13032.00	13035.78	16
Tailgate	CR20906	E55	129.5"	3.78	13073.00	13076.78	16
V20 Series 4-Wheel Drive							
Panel Doors	CV20906	ZW9	129.5"	3.78	14938.00	14941.78	16
Tailgate	CV20906	E55	129.5"	3.78	14979.00	14982.78	16
◆ 8-Cylinder 6.2 Liter (379 Cu. In.) L.D. Diesel V8 Engine-Engine Ordering Code LH6							
R10 Series 2-Wheel Drive							
Panel Doors	CR10906	ZW9&B3J	129.5"	N.A.	15193.00	15193.00	16
Tailgate	CR10906	E55&B3J	129.5"	N.A.	15235.00	15235.00	16
V10 Series 4-Wheel Drive							
Panel Doors	CV10906	ZW9&B3J	129.5"	N.A.	16762.00	16762.00	16
Tailgate	CV10906	E55&B3J	129.5"	N.A.	16803.00	16803.00	16
◆ 8-Cylinder 6.2 Liter (379 Cu. In.) H.D. Diesel V8 Engine-Engine Ordering Code LL4							
R20 Series 2-Wheel Drive							
Panel Doors	CR20906	ZW9&B3J	129.5"	3.78	15665.00	15668.78	16
Tailgate	CR20906	E55&B3J	129.5"	3.78	15708.00	15711.78	16
V20 Series 4-Wheel Drive							
Panel Doors	CV20906	ZW9&B3J	129.5"	3.78	17300.00	17303.78	16
Tailgate	CV20906	E55&B3J	129.5"	3.78	17341.00	17344.78	16

★ Manufacturer's Suggested Retail Prices do not include applicable destination charges, state and local taxes, license fees, optional equipment or special items or services.

◆ Refer to Power Team Chart for California Emission Certification Requirements.

OPTIONS WHEN INSTALLED BY GENERAL MOTORS

Prices shown are effective with initial shipments of 1987 model motor vehicles

Description	Option Number	Factory D&H(a)	List Price	Mfr's Suggested Retail Price◇
Scottsdale/High Sierra: (See Interior and Exterior Color Selection Chart) Not available when YE9 is specified. Includes B84 Black Body Side Moldings, turn signal and side marker lamp bezels, bright taillight trim, dual horns, nameplates on front fender and instrument panel, U37 Cigarette Lighter, dome lamp with bright bezels, bright sill plates and special insulation. Also includes spare tire cover when spare tire is specified.				
Without B3J Diesel Equipment. Also includes B85 Headliner	Z62	N.A.	485.00	485.00
With B3J Diesel Equipment	Z62	N.A.	329.00	329.00
Silverado/Sierra Classic: Available only when custom vinyl or cloth seats are specified. Includes wheel opening moldings, custom steering wheel, YG3 Deluxe Molding Package, bright taillight trim and rear door or tailgate moldings, bright front turn signal and front side marker lamp bezels, fender nameplates, carpeting, bright sill plates, plastic door trim panels with storage pockets and bright brushed-finish accents, dual horns, visor mirror, B85 Bright Body Side Moldings, V22 Deluxe Front Appearance, nameplate on instrument panel, U37 Cigarette Lighter, dome lamp with bright bezels, special insulation, pillar trim panels, Z53 Voltmeter, Temperature, and Oil Pressure Gages. Also includes spare tire cover when spare tire is specified.				
Without B3J Diesel Equipment. Also includes B85 Headliner	YE9	N.A.	1330.00	1330.00
With B3J Diesel Equipment	YE9	N.A.	1176.00	1176.00

(a) D & H Charges on vehicle and optional equipment include reimbursement to ordering Division for any tax that it has paid, incurred or agreed to pay thereon.

◇ State and local taxes not included.

R-V SUBURBAN

OPTIONS WHEN INSTALLED BY GENERAL MOTORS

Prices shown are effective with initial shipments of 1987 model motor vehicles

Description	Option Number	Factory D&H(a)	List Price	Mfr's Suggested Retail Price [◇]
Seat Trim: Driver and Passenger. (See Interior and Exterior Color Selection Chart for ordering information)				
V**1 Vinyl Bench Seat. Not available when Z62 or YE9 is specified	...		NO ADDITIONAL CHARGE	
L**1 Custom Cloth Bench Seat. Available only when Z62 or YE9 is specified.				
With Z62				
Without AT5 or AS3 Seats	...	N.A.	52.00	52.00
With AT5 Center Seat without AS3 Center and Rear Seats. Includes full floor mats	...	N.A.	126.00	126.00
With AS3 Center and Rear Seats. Includes full floor mats	...	N.A.	180.00	180.00
With YE9				
Without AT5 or AS3 Seats	...		NO ADDITIONAL CHARGE	
With AT5 Center Seat without AS3 Center and Rear Seats. Includes full carpeting	...	N.A.	149.00	149.00
With AS3 Center and Rear Seats. Includes full carpeting	...	N.A.	202.00	202.00
X**1 Custom Vinyl Bench Seat. Available only when Z62 or YE9 is specified.				
With Z62				
Without AT5 or AS3 Seats	...	N.A.	52.00	52.00
With AT5 Center Seat without AS3 Center and Rear Seats. Includes full floor mats	...	N.A.	126.00	126.00
With AS3 Center and Rear Seats. Includes full floor mats	...	N.A.	180.00	180.00
With YE9				
Without AT5 or AS3 Seats	...		NO ADDITIONAL CHARGE	
With AT5 Center Seat without AS3 Center and Rear Seats. Includes full carpeting	...	N.A.	149.00	149.00
With AS3 Center and Rear Seats. Includes full carpeting	...	N.A.	202.00	202.00
L**6 Custom Cloth Reclining Bucket Seats. Includes console and folding armrests				
Without AT5 or AS3 Seats	...	N.A.	385.00	385.00
With AT5 Center Seat without AS3 Center and Rear Seats. Includes full carpeting	...	N.A.	534.00	534.00
With AS3 Center and Rear Seats. Includes full carpeting	...	N.A.	586.00	586.00
X**6 Custom Vinyl Reclining Bucket Seats. Includes console and folding armrests				
Without AT5 or AS3 Seats	...	N.A.	385.00	385.00
With AT5 Center Seat without AS3 Center and Rear Seats. Includes full carpeting	...	N.A.	534.00	534.00
With AS3 Center and Rear Seats. Includes full carpeting	...	N.A.	586.00	586.00
Paints, Exterior: (See Interior and Exterior Color Selection Chart for ordering information).				
Solid	ZY1		NO ADDITIONAL CHARGE	
Special Two-Tone.				
Without Z62 or YE9. Includes YG1 Custom Molding Package and wheel opening moldings	ZY3	N.A.	345.00	345.00
With Z62. Includes YG1 Custom Molding Package and wheel opening moldings	ZY3	N.A.	210.00	210.00
With YE9	ZY3	N.A.	180.00	180.00
Exterior Decor Package. Includes dual-tone side and rear decal striping				
Without Z62 or YE9. Also includes YG1 Custom Package and wheel opening moldings	ZY5	N.A.	512.00	512.00
With Z62. Also includes YG1 Custom Package and wheel opening moldings	ZY5	N.A.	376.00	376.00
With YE9	ZY5	N.A.	347.00	347.00
Emission Systems: Dealer Note - One of the following emission options must be specified. (See Power Teams Chart for availability and complete specifications)				
California Emission Requirements: Not available when LH6 6.2 Liter Diesel Engine, L03 5.0 Liter Engine, NA5 Standard or NA6 High Altitude Emissions are specified. Includes all testing, equipment and/or certification necessary for registration in the State of California				
	YF5	N.A.	99.00	99.00
High Altitude Emission Equipment. Not available when NA5 Standard or YF5 California Emissions are specified				
	NA6		NO ADDITIONAL CHARGE	
Standard Emission Equipment. Not available when YF5 California or NA6 High Altitude Emissions are specified				
	NA5		NO ADDITIONAL CHARGE	

(a) D & H Charges on vehicle and optional equipment include reimbursement to ordering Division for any tax that it has paid, incurred or agreed to pay thereon.
[◇] State and local taxes not included.

R-V SUBURBAN

OPTIONS WHEN INSTALLED BY GENERAL MOTORS

Prices shown are effective with initial shipments of 1987 model motor vehicles

Description	Option Number	Factory D&H(a)	List Price	Mfr's Suggested Retail Price◇
Engines: (See Power Teams Chart for availability and complete specifications)				
Gasoline.				
5.0 Liter (305 Cu. In.) E.F.I. V8. R1 Series only	L03			NO ADDITIONAL CHARGE
5.7 Liter (350 Cu. In.) E.F.I. V8. Standard on V1, R-V2 Series. R1 Series only	L05			NO ADDITIONAL CHARGE
7.4 Liter (454 Cu. In.) E.F.I. V8. R2 Series only. Available only when N41 Power Steering and UA1 H.D. Battery are specified	L19	N.A.	385.00	385.00
Diesel.				
6.2 Liter (379 Cu. In.) L.D. V8 Diesel. R-V1 Series only. Available only when B3J Diesel Equipment is specified. Not available when YF5 California Emission Requirements is specified	LH6			NO ADDITIONAL CHARGE
6.2 Liter (379 Cu. In.) H.D. V8 Diesel. R-V2 Series only. Available only when B3J Diesel Equipment is specified	LL4			NO ADDITIONAL CHARGE
Transmissions:				
4-Speed Manual. R2 or V1-2 Series only. Not available when L19 7.4 Liter Engine or B3J Diesel Equipment is specified	MM4			NO ADDITIONAL CHARGE
4-Speed Automatic Overdrive. Standard on R1 Gasoline and Diesel Series and V1 Diesel Series.	MX0	N.A.	735.00	735.00
3-Speed Automatic. R-V2 Series only. Standard with B3J Diesel Equipment	MX1	N.A.	585.00	585.00
Axles, Rear: (See Power Teams Chart for option number selection, availability and complete specifications)				
Optional Ratio	...	N.A.	38.00	38.00
Locking Differential	G80	N.A.	252.00	252.00
Tires: (See Tire Charts for Tire Availability)				
All rim sizes are 6.00" on R-V1 Series except when N67, PF2 or PA6 wheels are specified.				
All rim sizes are 6.50" on R-V2 Series.				
TUBELESS				
P215/75R15 All Seasons Steel Belted Radial Ply Blackwall (Maximum Capacity 1583-lbs)				
V1 Series only. Not available when B3J Diesel Equipment is specified				
Front (Standard)	XCU			NO ADDITIONAL CHARGE
Rear (Standard)	YCU			NO ADDITIONAL CHARGE
Spare (Standard)	ZCU			NO ADDITIONAL CHARGE
P215/75R15 All Seasons Steel Belted Radial Ply Whitewall. (Maximum Capacity 1583-lbs).				
Front	XCV	N.C.	30.00	30.00
Rear	YCV	N.C.	30.00	30.00
Spare	ZCV	N.C.	15.00	15.00
P235/75R15 All Seasons Steel Belted Radial Ply Blackwall (Maximum Capacity 1843-lbs)				
Front				
R1 Series only (Standard). Not available when B3J Diesel Equipment is specified	XFL			NO ADDITIONAL CHARGE
V1 Series only				
Without B3J Diesel Equipment	XFL	N.C.	52.00	52.00
With B3J Diesel Equipment (Standard)	XFL			NO ADDITIONAL CHARGE
Rear				
R1 Series only (Standard). Not available when B3J Diesel Equipment is specified	YFL			NO ADDITIONAL CHARGE
V1 Series only				
Without B3J Diesel Equipment	YFL	N.C.	52.00	52.00
With B3J Diesel Equipment (Standard)	YFL			NO ADDITIONAL CHARGE
Spare				
R1 Series only (Standard). Not available when B3J Diesel Equipment is specified	ZFL			NO ADDITIONAL CHARGE
V1 Series only				
Without B3J Diesel Equipment	ZFL	N.C.	26.00	26.00
With B3J Diesel Equipment (Standard)	ZFL			NO ADDITIONAL CHARGE

(a) D & H Charges on vehicle and optional equipment include reimbursement to ordering Division for any tax that it has paid, incurred or agreed to pay thereon.
◇ State and local taxes not included.

R-V SUBURBAN

OPTIONS WHEN INSTALLED BY GENERAL MOTORS

Prices shown are effective with initial shipments of 1987 model motor vehicles

Description	Option Number	Factory D&H(a)	List Price	Mfr's Suggested Retail Price ^o
Tires: (Continued)				
<i>P235/75R15 On-Off Road Steel Belted Radial Ply Blackwall</i> (Maximum Capacity 1843-lbs)				
Front. V1 Series only				
Without B3J Diesel Equipment	YES	N.C.	74.00	74.00
With B3J Diesel Equipment	YES	N.C.	22.00	22.00
Rear				
R1 Series only. Not available when B3J Diesel Equipment is specified ..				
V1 Series only	YES	N.C.	22.00	22.00
Without B3J Diesel Equipment	YES	N.C.	74.00	74.00
With B3J Diesel Equipment	YES	N.C.	22.00	22.00
Spare				
R1 Series only. Not available when B3J Diesel Equipment is specified ..				
V1 Series only	ZES	N.C.	11.00	11.00
Without B3J Diesel Equipment	ZES	N.C.	37.00	37.00
With B3J Diesel Equipment	ZES	N.C.	11.00	11.00
<i>P235/75R15 All Seasons Steel Belted Radial Ply Whitewall</i> (Maximum Capacity 1843-lbs)				
Front				
R1 Series only. Not available when B3J Diesel Equipment is specified ..				
V1 Series only	XFM	N.C.	36.00	36.00
Without B3J Diesel Equipment	XFM	N.C.	88.00	88.00
With B3J Diesel Equipment	XFM	N.C.	36.00	36.00
Rear				
R1 Series only. Not available when B3J Diesel Equipment is specified ..				
V1 Series only	YFM	N.C.	36.00	36.00
Without B3J Diesel Equipment	YFM	N.C.	88.00	88.00
With B3J Diesel Equipment	YFM	N.C.	36.00	36.00
Spare				
R1 Series only. Not available when B3J Diesel Equipment is specified ..				
V1 Series only	ZFM	N.C.	18.00	18.00
Without B3J Diesel Equipment	ZFM	N.C.	44.00	44.00
With B3J Diesel Equipment	ZFM	N.C.	18.00	18.00
<i>P235/75R15 All Seasons Steel Belted Radial Ply Blackwall</i> (Maximum Capacity 1984-lbs). Standard on R1 Series when B3J Diesel Equipment is specified				
Front				
R1 Series only				
Without B3J Diesel Equipment	XHA	N.C.	20.00	20.00
With B3J Diesel Equipment	XHA	NO ADDITIONAL CHARGE		
V1 Series only				
Without B3J Diesel Equipment	XHA	N.C.	72.00	72.00
With B3J Diesel Equipment	XHA	N.C.	20.00	20.00
Rear				
R1 Series only				
Without B3J Diesel Equipment	YHA	N.C.	20.00	20.00
With B3J Diesel Equipment	YHA	NO ADDITIONAL CHARGE		
V1 Series only				
Without B3J Diesel Equipment	YHA	N.C.	72.00	72.00
With B3J Diesel Equipment	YHA	N.C.	20.00	20.00
Spare				
R1 Series only				
Without B3J Diesel Equipment	ZHA	N.C.	10.00	10.00
With B3J Diesel Equipment	ZHA	NO ADDITIONAL CHARGE		
V1 Series only				
Without B3J Diesel Equipment	ZHA	N.C.	36.00	36.00
With B3J Diesel Equipment	ZHA	N.C.	10.00	10.00

(a) D & H Charges on vehicle and optional equipment include reimbursement to ordering Division for any tax that it has paid, incurred or agreed to pay thereon.
^o State and local taxes not included.

R-V SUBURBAN

OPTIONS WHEN INSTALLED BY GENERAL MOTORS

Prices shown are effective with initial shipments of 1987 model motor vehicles

Description	Option Number	Factory D&H(a)	List Price	Mfr's Suggested Retail Price [◇]
Tires: (Continued)				
<i>P235/75R15 All Seasons Steel Belted Radial Ply Whitewall</i> (Maximum Capacity 1984-lbs)				
Front				
R1 Series only				
Without B3J Diesel Equipment	XHB	N.C.	58.00	58.00
With B3J Diesel Equipment	XHB	N.C.	38.00	38.00
V1 Series only				
Without B3J Diesel Equipment	XHB	N.C.	110.00	110.00
With B3J Diesel Equipment	XHB	N.C.	58.00	58.00
Rear				
R1 Series only				
Without B3J Diesel Equipment	YHB	N.C.	58.00	58.00
With B3J Diesel Equipment	YHB	N.C.	38.00	38.00
V1 Series only				
Without B3J Diesel Equipment	YHB	N.C.	110.00	110.00
With B3J Diesel Equipment	YHB	N.C.	58.00	58.00
Spare				
R1 Series only				
Without B3J Diesel Equipment	ZHB	N.C.	29.00	29.00
With B3J Diesel Equipment	ZHB	N.C.	19.00	19.00
V1 Series only				
Without B3J Diesel Equipment	ZHB	N.C.	55.00	55.00
With B3J Diesel Equipment	ZHB	N.C.	29.00	29.00
<i>LT235/85R16D Highway Steel Belted Radial Ply Blackwall</i> (Maximum Capacity 2623-lbs) R-V2 Series only.				
Front. (Standard)	XYM		NO ADDITIONAL CHARGE	
<i>LT235/85R16E Highway Steel Belted Radial Ply Blackwall</i> (Maximum Capacity 3042-lbs) R-V2 Series only.				
Front	XYN	.14	32.00	32.14
Rear. (Standard)	YYN		NO ADDITIONAL CHARGE	
Spare	ZYN	.98	352.00	352.98
<i>LT235/85R16E On-Off Road Steel Belted Radial Ply Blackwall</i> (Maximum Capacity 3042-lbs.)				
Front. V2 Series only	XYT	.88	88.00	88.88
Rear. R-V2 Series only	YYT	.74	56.00	56.74
Spare. R-V2 Series only	ZYT	1.35	380.00	381.35

OTHER OPTIONS

Air Cleaner, Pre-Cleaner	K46	N.A.	44.00	44.00
Air Conditioning: All-Weather. Not available when V10 Cold-Climate Package is specified. Includes extra cooling. Front. Included when C69 Front and Rear Air Conditioning is specified. Recommended for front seat area cooling only.				
Without B3J Diesel Equipment				
Without Z62 or YE9. Also includes 8B5 Headliner	C60	N.A.	940.00	940.00
With Z62 or YE9	C60	N.A.	781.00	781.00
With B3J Diesel Equipment. Includes 78-Amp Generator				
Front and Rear. Rear Interior Roof Mounted. Available only when YE9 or Z62 is specified. Rear system operates on recirculating air.	C80	N.A.	719.00	719.00
Without B3J Diesel Equipment. Includes 105-Amp Generator				
With B3J Diesel Equipment. Includes 78-Amp Generator	C89	N.A.	1227.00	1227.00
	C89	N.A.	1161.00	1161.00
Appearance, Deluxe Front: Included when YE9 is specified. Includes dark argent grille with bright trim and dual rectangular headlamps.				
	V22	N.A.	115.00	115.00
Batteries: 12-Volt. Not available when B3J Diesel Equipment is specified.				
Auxiliary. 540 Cold Cranking Amps Delco Freedom	TP2	N.A.	134.00	134.00
Heavy-Duty. 630 Cold Cranking Amps Delco Freedom. Included when V10 Cold-Climate Package is specified	UA1	N.A.	56.00	56.00
Bumper Equipment:				
Bumpers, Deluxe. Front and Rear. Not available when V31 Bumper Guards are specified. Includes front and rear bumpers and black resilient impact strips				
Guards, Chromed. Front Bumper	VE5	N.A.	51.00	51.00
	V31	N.A.	43.00	43.00

(a) D & H Charges on vehicle and optional equipment include reimbursement to ordering Division for any tax that it has paid, incurred or agreed to pay thereon.

◇ State and local taxes not included.

R-V SUBURBAN

OPTIONS WHEN INSTALLED BY GENERAL MOTORS

Prices shown are effective with initial shipments of 1987 model motor vehicles

Description	Option Number	Factory D&H(a)	List Price	Mfr's Suggested Retail Price◇
OTHER OPTIONS				
Clock: Quartz Electric Not available when UM6 Radio is specified				
Without YE9. Includes Z53 Voltmeter, Temperature and Oil Pressure Gages	U35	N.A.	83.00	83.00
With YE9	U35	N.A.	41.00	41.00
Cold-Climate Package: Not available when B3J Diesel Equipment, C60 Front or C69 Front and Rear Air Conditioning is specified. Includes special heater and defroster, K05 Engine Block Heater, anti-freeze protection to -32 degrees, and UA1 H.D. Battery.	V10	N.A.	134.00	134.00
Cooling System: Recommended for heavy-duty trailering.				
Engine Oil. Not available when B3J Diesel Equipment is specified. Included when Z82 Trailing Special is specified	KC4	N.A.	126.00	126.00
Radiator, Heavy-Duty. Not available when B3J Diesel Equipment, C60 Front or C69 Front and Rear Air Conditioning is specified. R-V2 Series also not available when MX0 or MX1 Automatic Transmission is specified	V01	N.A.	58.00	56.00
Radiator and Transmission Oil, Heavy-Duty. Available only when MX0 or MX1 Automatic Transmission is specified. Not available when V01 H.D. Raditor is specified. Included when Z82 Trailing Special is specified.	V02	N.A.	63.00	63.00
Defogger, Rear Window: Electric. Available only when A33 Power Tailgate Window is specified. Not available when AJ1 Deep Tinted Glass is specified.				
Without B3J Diesel Equipment.	C49	N.A.	154.00	154.00
With B3J Diesel Equipment. Includes 78-Amp Generator	C49	N.A.	92.00	92.00
Door Lock System, Power: Side and Rear Doors. Available only when BB5 Headliner, B3J Diesel Equipment, Z62, YE9, C60 Front or C69 Front and Rear Air Conditioning is specified. Included with ZQ2 Operating Convenience Package				
With E55 Tailgate	AU3	N.A.	211.00	211.00
With ZW9 Body	AU3	N.A.	275.00	275.00
Floor Covering: Mats, Color-Keyed, Floor, Removable. Available only when YE9 is specified				
Front only	B32	N.A.	16.00	16.00
Rear only. Available only when B32 Front Mats are specified	B33	N.A.	22.00	22.00
Gages: Voltmeter, Temperature and Oil Pressure. Included when YE9 or U35 Electric Clock is specified	Z53	N.A.	42.00	42.00
Glass:				
Deep Tinted. Not available when C49 Defogger is specified. Includes tinted glass on passenger and driver's side door. Also includes dark laminated glass on side windows and rear door	AJ1	N.A.	298.00	298.00
Deep Tinted with Light Tinted Rear Window. Not available when AJ1 Deep Tinted Glass is specified. Includes tinted glass on passenger, driver's side and rear doors. Also includes dark laminated glass on side windows	AA3	N.A.	252.00	252.00
Harness, Trailer Wiring: Heavy-Duty 7-Lead. Included when Z82 Trailing Special is specified	UY7	N.A.	46.00	46.00
Headlamps: Halogen Hi-Beam. Available only when V22 Deluxe Front Appearance Package or YE9 is specified				
	TT5	N.A.	18.00	18.00
	T63	N.A.	12.00	12.00
Headlamp Warning Buzzer				
Headliner, Interior: Full Length. Included when YE9, Z62, B3J Diesel Equipment, C60 Front or C69 Front and Rear Air Conditioning is specified. Includes dome lamp	BB5	N.A.	160.00	160.00
Heaters:				
Engine Block, 600 Watts, 120 Volts. Not available when B3J Diesel Equipment is specified. Included when V10 Cold-Climate Package is specified	K05	N.A.	33.00	33.00
Rear. Located on right side, behind rear fender well.				
Without B3J Diesel Equipment	C36	N.A.	267.00	267.00
With B3J Diesel Equipment. Includes 78-Amp Generator	C36	N.A.	205.00	205.00
Front, Heavy-Duty. Not available when C60 Front or C69 Front and Rear Air Conditioning is specified	C42	N.A.	45.00	45.00
Hubs: V1-2 Series only				
Automatic Locking	X6Z	N.A.	60.00	60.00
Manual	X8W	NO ADDITIONAL CHARGE		
Lamps: Roof Marker, Five. Not available when YF5 California Emissions is specified.	U01	N.A.	52.00	52.00

- (a) D & H Charges on vehicle and optional equipment include reimbursement to ordering Division for any tax that it has paid, incurred or agreed to pay thereon.
 ◇ State and local taxes not included.

R-V SUBURBAN

OPTIONS WHEN INSTALLED BY GENERAL MOTORS

Prices shown are effective with initial shipments of 1987 model motor vehicles

Description	Option Number	Factory D&H(s)	List Price	Mfr's Suggested Retail Price◇
OTHER OPTIONS				
Lighter, Cigarette: Included when YE9 or Z62 is specified	U37	N.A.	32.00	32.00
Mirrors, Exterior: LH and RH.				
Below-Eye-Line Type. 9" x 6.5"				
Painted	D44	N.A.	52.00	52.00
Stainless Steel	D45	N.A.	87.00	87.00
Camper Type. 7.5" x 10.5". Stainless steel. Adjustable arm feature to provide field of vision for vehicles to 98" wide. Shipped loose for dealer installation	DF2	N.A.	100.00	100.00
Moldings:				
Body Side, Black. Bright with black insert. Not available when YE9, B85 Bright Body Side Molding or YG3 Deluxe Molding Package is specified. Included when YG1 Custom Molding Package, ZY3 Special Two-Tone Paint, ZY5 Exterior Decor Package or Z62 is specified. Includes lower side and rear moldings of black plastic with bright trim	B84	N.A.	121.00	121.00
Body Side, Bright. Not available when ZY3 Special Two-Tone Paint, ZY5 Exterior Decor Package, B84 Black Body Side Moldings or YG1 Custom Molding Package is specified. Included when YG3 Deluxe Molding Package or YE9 is specified. Includes bright plastic body side and rear lower moldings with black paint trim plus bright trim for front side marker lamps and taillights				
Without Z62	B85	N.A.	152.00	152.00
With Z62	B85	N.A.	16.00	16.00
Custom Package. Not available when B85 Bright Body Side Moldings, YE9 or YG3 Deluxe Molding Package is specified. Included when ZY3 Special Two-Tone Paint or ZY5 Exterior Decor Package is specified. Includes bright trim for front side marker lamps and taillights, B84 Black Body Side and wheel opening moldings.				
Without Z62	YG1	N.A.	166.00	166.00
With Z62	YG1	N.A.	31.00	31.00
Deluxe Package. Included when YE9 is specified. Includes B85 Bright Body Side Moldings, bright trim for front side marker lamps and taillights and wheel opening moldings.				
Without ZY3 Special Two-Tone Paint, Z62 or ZY5 Exterior Decor Package	YG3	N.A.	183.00	183.00
With ZY3 Special Two-Tone Paint or ZY5 Exterior Decor Package	YG3	N.A.	17.00	17.00
With Z62	YG3	N.A.	46.00	46.00
Guards, Door Edge	B93	N.A.	24.00	24.00
Operating Convenience Package: Available only when Z62, YE9, B3J Diesel Equipment, C80 Front or C69 Front and Rear Air Conditioning or B85 Interior Headliner is specified. Includes A31 Power Windows and AU3 Power Side and Rear Door Locks				
With E55 Tailgate	ZQ2	N.A.	519.00	519.00
With ZW9 Body	ZQ2	N.A.	583.00	583.00
Preliminary Price Information	B3W	N.A.	N.A.	N.A.
Radio Equipment:				
AM Radio	U63	N.A.	122.00	122.00
AM/FM Radio	U69	N.A.	181.00	181.00
AM/FM Stereo Radio	U68	N.A.	208.00	208.00
AM/FM Stereo Radio with Stereo Cassette Tape	UN3	N.A.	308.00	308.00
AM/FM Stereo Radio with Seek and Scan, Stereo Cassette Tape and Digital Clock.				
Includes dual rear speakers	UM6	N.A.	429.00	429.00
Windshield Antenna. Included with Radio	U78	N.A.	34.00	34.00
Seats: Seat trim matches front seat whether standard or optional. Includes seat area floor covering, floor insulation and (3) seat belts. Dealer Note - One of the following seat options must be specified. (Added weight includes passenger weight allowance of 150-lbs per seating position. Refer to vehicle and option weight section of Data Book).				
Center only. Non-adjustable type with independent LH and RH folding sections	AT5	N.A.	401.00	401.00
Center and Rear. Includes non-adjustable center and quick release removable type rear seats, (3) additional seat belts plus LH and RH rear arm rests with ashtrays.				
R1 Series only. Available only when HA or HB P235/75R15 Tires are specified.				
Without B3J Diesel Equipment. Also includes F59 Stabilizer	AS3	N.A.	785.00	785.00
With B3J Diesel Equipment	AS3	N.A.	725.00	725.00
R-V2 or V1 Series only. V1 Series available only when HA or HB P235/75R15 Tires are specified	AS3	N.A.	725.00	725.00

(a) D & H Charges on vehicle and optional equipment include reimbursement to ordering Division for any tax that it has paid, incurred or agreed to pay thereon.

◇ State and local taxes not included.

R-V SUBURBAN

OPTIONS WHEN INSTALLED BY GENERAL MOTORS

Prices shown are effective with initial shipments of 1987 model motor vehicles

Description	Option Number	Factory D&H(a)	List Price	Mfr's Suggested Retail Price◇
OTHER OPTIONS				
Seats: (Continued)				
Optional Seat Not Desired	YG4		NO ADDITIONAL CHARGE	
Shield, Fuel Tank:				
R1-2 Series only.				
Without NE2 Fuel Tank	NY1	N.A.	51.00	51.00
With NE2 Fuel Tank	NY1	N.A.	130.00	130.00
V1-2 Series only. Includes transfer case skid plate.				
Without NE2 Fuel Tank	NY1	N.A.	96.00	96.00
With NE2 Fuel Tank	NY1	N.A.	175.00	175.00
Shock Absorbers: Front and Rear, Heavy-Duty. R1 Series only. Standard on R-V2 Series. Included when Z82 Trailing Special is specified	F51	N.A.	36.00	36.00
Shocks, Front Quad: V1-2 Series only. Includes dual left and right hand shock absorbers on front, heavy-duty shock absorbers on rear and a front axle nose bumper to limit axle windup.				
V1 Series only	Z75	N.A.	136.00	136.00
V2 Series only	Z75	N.A.	100.00	100.00
Speed Control, Electronic: Not available when MM4 4-Speed Transmission is specified	K34	N.A.	205.00	205.00
Springs: Front, Heavy-Duty. Capacity 2250-lb each.				
V1 Series only. Recommended for snowplow type usage only.				
Without Z75 Front Quad Shock Absorbers. Includes H.D. front and rear shock absorbers	F60	N.A.	98.00	98.00
With Z75 Front Quad Shock Absorbers	F60	N.A.	63.00	63.00
V2 Series only	F60	N.A.	63.00	63.00
Stabilizers:				
Front. 1" diameter. R1 Series only. Included when AS3 Seats or B3J Diesel Equipment is specified	F59	N.A.	40.00	40.00
Front, Heavy-Duty. 1.25" diameter. R2 Series only. Standard on V1-2 Series ..	F58	N.A.	19.00	19.00
Steering:				
Power. Standard on V1-2 Series. Included when Z82 Trailing Special or B3J Diesel Equipment is specified	N41	N.A.	275.00	275.00
Power, Not Desired. R1-2 Series only. Not available when Z82 Trailing Special or B3J Diesel Equipment is specified	N51		NO ADDITIONAL CHARGE	
	N33	N.A.	121.00	121.00
Steering Wheel: Comfortilt				
Tanks, Fuel: Replaces production fuel tank.				
Approximately 31-Gallon Capacity for Gasoline and 32-Gallon Capacity for Diesel	NK7	N.A.	45.00	45.00
Approximately 40-Gallon Capacity for Gasoline and 41-Gallon Capacity for Diesel	NE2	N.A.	105.00	105.00
Towing Device: Two front towing hooks.	V76	N.A.	38.00	38.00
Trailer Hitch:				
Deadweight Type. Not available when Z82 Trailing Special is specified	VR2	N.A.	62.00	62.00
Weight Distributing Platform Type. Not available when VR2 Deadweight Type Trailer Hitch is specified. Included when Z82 Trailing Special is specified	VR4	N.A.	164.00	164.00
Trailing Special Equipment: Includes VR4 Weight Distributing Hitch Platform, UY7 Wiring Harness and V02 H.D. Radiator Transmission Oil Cooler. (See Trailing Guide for GCW Ratings with available power team combinations.)				
R1 Series only. Available only when 3.73 or 3.42 rear axle ratio is specified. With B3J Diesel Equipment not available when YF5 California Emissions are specified. Also includes F51 H.D. Shock Absorbers.				
Without B3J Diesel Equipment. Available only when L05 5.7 Liter Engine is specified. Also includes KC4 Engine Oil Cooler and N41 Power Steering	Z82	N.A.	709.00	709.00
With B3J Diesel Equipment	Z82	N.A.	272.00	272.00
R2 Series only. Available only when MX0 or MX1 Automatic Transmission is specified.				
Without B3J Diesel Equipment. Also includes N41 Power Steering and KC4 Engine Oil Cooler.	Z82	N.A.	673.00	673.00
With B3J Diesel Equipment	Z82	N.A.	272.00	272.00
V1-2 Series only. V2 Series available only when MX0 or MX1 Automatic Transmission is specified. LT9 5.7 Liter Engine on V2 Series also available only when 4.10 Rear Axle Ratio is specified. V1 Series available only when MX0 Automatic Transmission and 3.42 or 3.73 Rear Axle Ratio is specified. V1 Series also requires V01 H.D. Radiator unless C60 Front or C69 Front and Rear Air Conditioning is specified.				
Without B3J Diesel Equipment. Also includes KC4 Engine Oil Cooler.	Z82	N.A.	398.00	398.00
With B3J Diesel Equipment	Z82	N.A.	272.00	272.00

(a) D & H Charges on vehicle and optional equipment include reimbursement to ordering Division for any tax that it has paid, incurred or agreed to pay thereon.
 ◇ State and local taxes not included.

R-V SUBURBAN

OPTIONS WHEN INSTALLED BY GENERAL MOTORS

Prices shown are effective with initial shipments of 1987 model motor vehicles

Description	Option Number	Factory D&H(s)	List Price	Mfr's Suggested Retail Price ◊
OTHER OPTIONS				
Wheel Trim:				
Wheel Covers, R-V1 Series only	P01	N.A.	42.00	42.00
Wheel Covers, Special, Bright Metal, R-V2 Series only	PA1	N.A.	124.00	124.00
Wheels:				
Rally, R-V1 Series only. Includes special hub caps, trim rings and 15" x 8" wheels Not available when P215/75R15 tires are specified	N87	N.A.	121.00	121.00
Styled, V1 Series only. Four Wheels only. Includes 15" x 8" wheels. Not available when P215/75R15 tires are specified	PA6	N.A.	185.00	185.00
Aluminum, Forged, R-V1 Series only. Four Wheels only. Includes 15" x 7" wheels and special hub caps	PF2	N.A.	449.00	449.00
Aluminum, Cast. Four Wheels only. Includes 15" x 7" wheels and special hub caps	N80	N.A.	318.00	318.00
Windows: Electric.				
Power Side Door Glass. Available only when BB5 Headliner, Z62, YE9, B3J Diesel Equipment, C60 Front or C69 Front and Rear Air Conditioning is specified. Included when ZQ2 Operating Convenience Package is specified	A31	N.A.	308.00	308.00
Power Tailgate. Available only when E55 Tailgate is specified	A33	N.A.	103.00	103.00
Windshield Wiper System: Intermittent	CD4	N.A.	59.00	59.00

(a) D & H Charges on vehicle and optional equipment include reimbursement to ordering Division for any tax that it has paid, incurred or agreed to pay thereon.
◊ State and local taxes not included.

NOTES

R/V SUBURBAN

**CAB & BODY FEATURES
CAB DIMENSIONS
SEATING ARRANGEMENTS
COLOR & TRIM CHARTS
TWO-TONES**

R/V SUBURBAN

CUSTOM DELUXE/SIERRA FEATURES—STANDARD MODEL

The Custom Deluxe/Sierra standard models include the following items as standard equipment



EXTERIOR

- **Bumpers:** Front and rear; chromed
- **Color:** See Interior and Exterior Color Selection Chart
- **Doors:** Four side doors, two LH and two RH; two rear panel doors (optional endgate with drop-glass available)
- **Glass:** Tinted; all windows; includes shade band on upper windshield
- **Grille and Headlamp Bezels:** Molded plastic; painted argent; integral Chevrolet emblem/GMC letters at center of grille
- **Horn:** Single, electric, low-note
- **Hub Caps:** Bright metal with black trim
- **Keys:** Two-key system with separate keys for ignition switch and door locks
- **Lights:**
 - Backup lamps: Two rear (integral with taillamps)
 - Combination parking/direction/hazard: Two front
 - Combination tail/stop/direction/hazard: Two rear
 - Headlamps: Two, rectangular
 - License plate lamp: Single rear
 - Side marker lamps with reflectors: Two front; two rear (integral with taillamps)
- **Mirrors:** RH and LH fixed arm with adjustable 5-7/16" wide x 4" high head; chrome finish
- **Moldings:** Bright, drip moldings over side and rear doors; headlamp and grille outline moldings
- **Nameplates:** Bright "Custom Deluxe/Sierra" nameplates, with series designation, on front fenders near doors; bright "Suburban" nameplate on RH rear door
- **Tools:** Mechanical jack and wheel wrench
- **Wheels:** Painted white
- **Windshield Wipers and Washers:** Electric, 2-speed wipers with black finish on exposed metal portions; wet-arm demand-type washer system



R/V SUBURBAN

CUSTOM DELUXE/SIERRA FEATURES—STANDARD MODEL

The Custom Deluxe/Sierra standard models include the following items as standard equipment

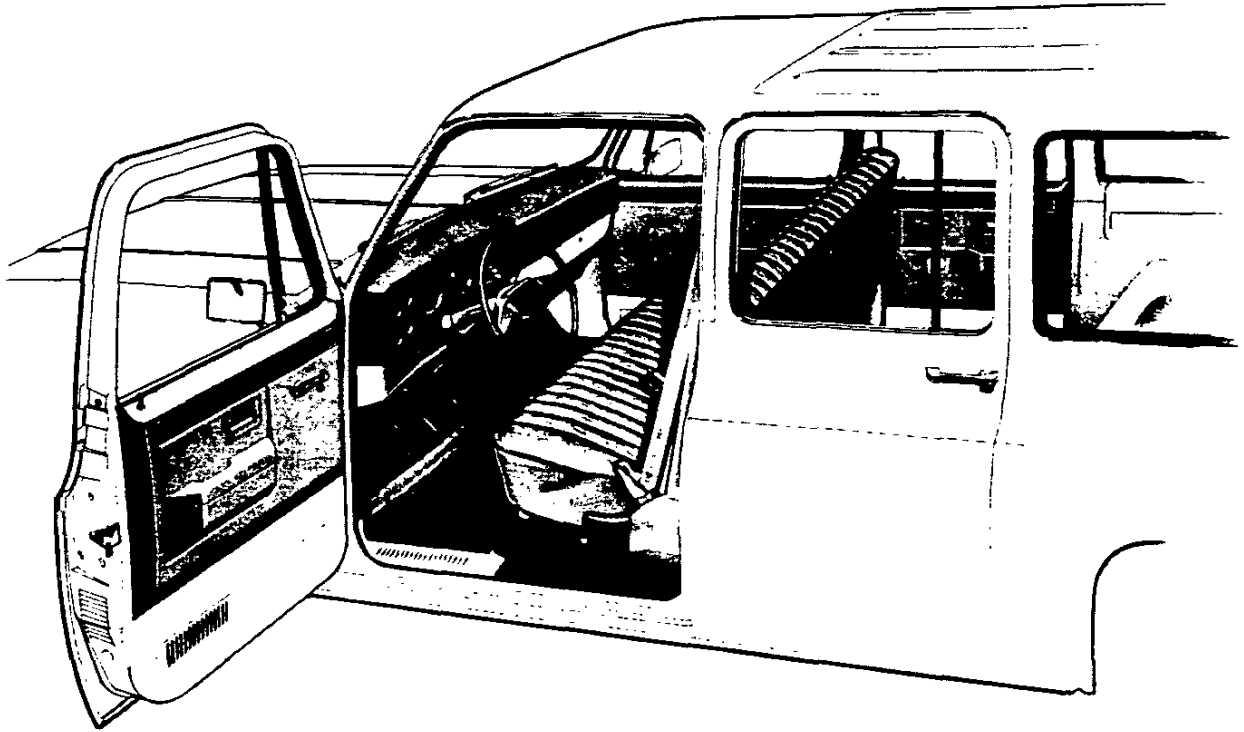

INTERIOR

- **Armrests:** RH and LH padded; integral with side door trim panels
- **Ashtrays:** In middle of instrument panel and in rear side door trim panels
- **Coat Hooks:** Over RH and LH rear side door openings
- **Colors:**
 - Painted areas: Same as exterior primary color choice
 - Interior trim: Coordinated with seat trim color choices
- **Floor Covering:** Embossed black rubber mats over entire floor area; color-keyed carpeting on rear face of seat backs on center seats (when optional center seats are ordered)
- **Heater and Defogger:** Deluxe-air
- **Hood Lock Release:** Handle located on LH side under instrument panel
- **Instrument Cluster Bezel:** Black crackle finish with bright trim
- **Instruments:**
 - Gages: Speedometer, odometer and fuel
 - Switches: Main, for control of exterior lights, instrument cluster lights, and interior lights; multi-function switch on steering column for direction signals by moving lever up or down (includes lane change position), headlamp beams by pulling lever toward driver, windshield wiper by turning band marked "WIPER" toward or away from driver, and windshield washer by pushing in the lever knob; ignition with key-in warning buzzer; hazard warning; heater fan
 - Warning lights: Generator, oil pressure, engine temperature, seat belt, service-parking brake, direction/hazard signal, high beam
- **Instrument Panel Control Knobs:** Soft black plastic (except heater and wiper-washer controls) with white graphic identification
- **Instrument Panel Pad:** Color-keyed, energy-absorbing foam type with grained vinyl skin; has black crackle finish applique on RH side with bright, black, and silver trim and bright "Custom Deluxe/Sierra" nameplate
- **Insulation and Sound Deadening Material:** Dash (firewall), under floor mats and under front seat at center (includes extra-thick insulation in center seat area when optional seat is ordered)
- **Lights:** Instrument cluster and cab interior lights
- **Mirror, Rearview:** 10" prismatic with soft vinyl rim
- **Seat:** Full-width, full-depth foam bench-type front seat only with embossed grained all-vinyl trim. See Interior and Exterior Color Selection Chart for color and trim availability
- **Seat Belts:** Front only; non-detachable combination lap and shoulder belts for outboard positions with automatic-locking retractors on lap belts; emergency-locking retractors on shoulder belts, and switch in driver's lap belt retractor for buzzer warning system; lap belt with manual adjustment for center position. All seat belts are color-keyed with pushbutton type buckles
- **Sill Plates:** Door-opening protection and floor mat retention; bright metal; partial for front side doors, full-length for rear side doors, and full-width front and rear for rear compartment platform
- **Spare Tire Carrier:** LH rear side
- **Steering Wheel and Column:** 16" black, soft plastic wheel with 2 spokes; black energy-absorbing steering column with anti-theft locking feature
- **Stowage Box:** In RH side of instrument panel; door has bright turn-type latch release
- **Sunshades:** RH and LH padded; color-keyed
- **Trim Panels:** Color-keyed, embossed molded plastic on side doors with integral armrests; painted steel panels on rear quarter areas

R/V SUBURBAN

SCOTTSDALE/HIGH SIERRA MODEL OPTION—RPO Z62

This option includes all Custom Deluxe/Sierra standard model items plus the additions or substitutions listed below

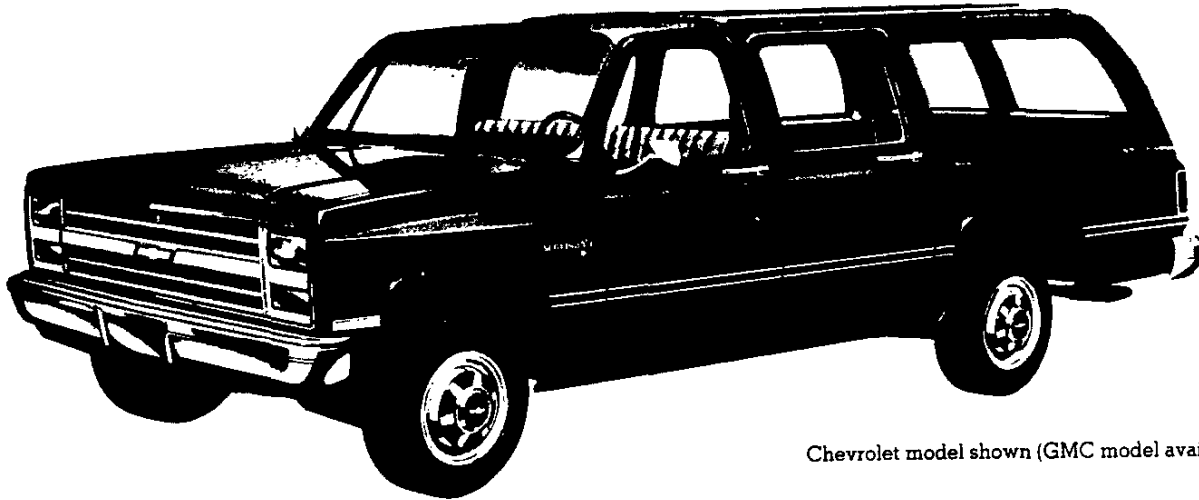

Chevrolet model shown (GMC model available)

EXTERIOR

- **Bright Appearance Items:**

- "Scottsdale/High Sierra" nameplates, with series designation, on front fenders
- Body side and rear molding trim
- Chevrolet emblem/GMC letters at grille center
- Dome lamp trim

Side marker lamp and taillamp trim

- **Horn:** Additional, electric, high-note
- **Moldings:** Black plastic body side and rear moldings with bright trim

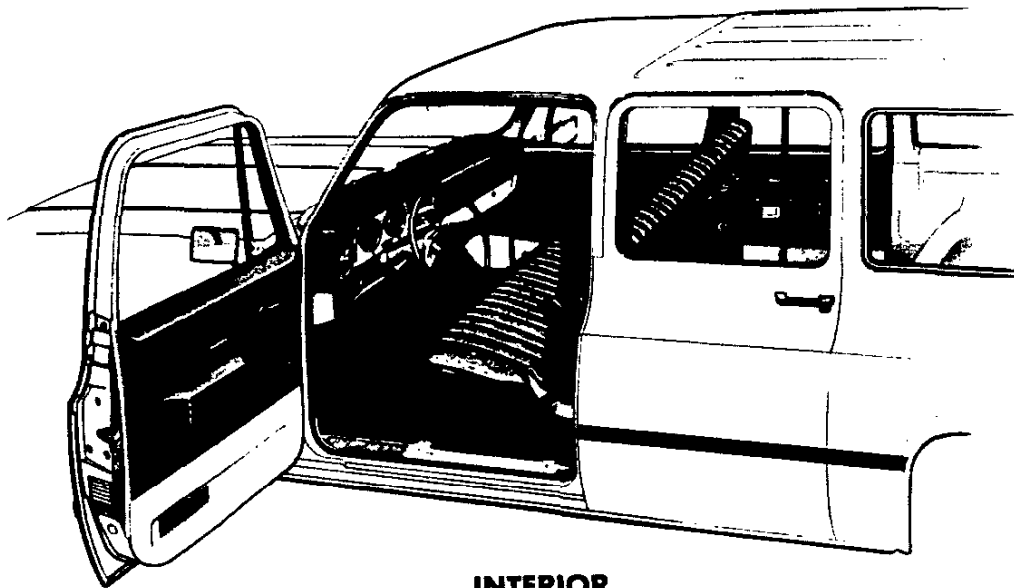

INTERIOR

- **Bright Appearance Items:**

- "Scottsdale/High Sierra" nameplate on instrument panel pad
- Trim on instrument cluster bezel and instrument panel pad applique
- **Cigar Lighter:** With fiber optic illuminated ashtray
- **Dome Lamps:** Two; one front, one rear
- **Dome and Interior Lamp Switches:** Front and rear side door actuated (dome and interior lamps also may be activated by main light switch)
- **Floor Covering:** Color-keyed rubber mat in front seat area (also in center and rear seat areas when optional center seat is ordered)
- **Headliner:** Full-length, color-keyed, perforated molded plastic

with fiberglass blanket backing; includes matching retainer moldings

- **Insulation:** Under cowl panel and on back of headliner
- **Pillar Trim Panels:** Color-keyed molded plastic on windshield pillars and center door pillars
- **Seats:** Embossed grained all-vinyl trim standard. Also available at extra cost: 1) textured velour cloth/vinyl trim; or 2) all-vinyl pigskin grained trim. See Interior and Exterior Color Selection Chart for color and trim availability
- **Sill Plates:** Full-length bright metal for front side doors
- **Spare Tire Cover:** Color-keyed carpet
- **Sunshades:** Mystic colored to match headliner

R/V SUBURBAN

SILVERADO/SIERRA CLASSIC MODEL OPTION—RPO YE9

This option includes all items in the Scottsdale model option plus the additions or substitutions listed below



GMC model shown (Chevrolet model available)

EXTERIOR

• **Bright Appearance Items:**

- "Silverado/Sierra Classic" nameplates, with series designation, on front fenders
- Chrome-trimmed grille and headlamp bezels (Chevrolet models only)
- Body side and rear door (or tailgate) moldings with black paint trim

Bright wheel opening lip moldings

- **Body-to-Fender Insulators**
- **Grille and Headlamp Bezel Paint:** Dark argent (Chevrolet); argent/dark argent (GMC)
- **Hood Insulator**
- **Special Headlamps:** Rectangular; dual RH and LH

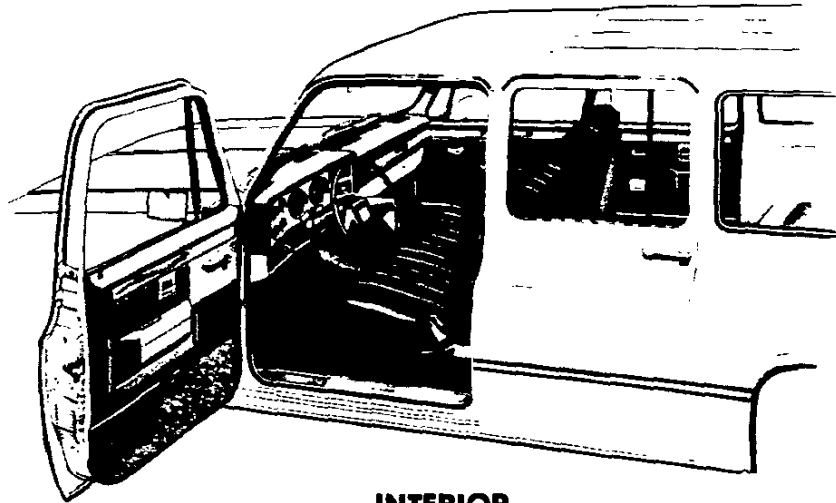

INTERIOR

• **Bright Appearance Items:**

- "Silverado/Sierra Classic" nameplate on instrument panel pad
- MM4 four-speed transmission shift lever (C1-2 models only)
- Trim on side door trim panels, and on horn button
- **Cowl Panel Trim:** Color-keyed molded plastic on entire surface of cowl side panels
- **Floor Covering:** Color-keyed carpeting; front seat area (also in center and rear seat areas and on wheelhousings)
- **Garnish Moldings:** Color-keyed molded plastic for body sides (in side rear window areas), lower rear lock pillars, and upper rear doors
- **Headliner:** Full length, color-keyed, foam backed cloth; includes matching retainer moldings
- **Instrument Cluster:** Voltmeter, engine temperature gage, and oil pressure gage replace warning lights; includes pewter-toned brush-finished bezel
- **Instrument Panel Pad Applique:** Pewter-toned brushed finish with bright, black, and silver trim
- **Insulation:** Extra-thick front compartment floor insulators, including full-width insulator under front seat (also in center and

rear seat areas when optional center seat is ordered), on back of headliner, and on body side trim panels

- **Seats:** Choice of: 1) all-vinyl pigskin grained trim; or 2) textured velour cloth/vinyl trim. Also available at extra cost: High back bucket seats are available in Custom Vinyl or Custom Cloth (includes console). See Interior and Exterior Color Selection Chart for color and trim availability
- **Trim Panels:** Color-keyed molded plastic door trim panels (with door closing assist strap and vinyl stowage pockets; on front door units only); includes pewter-toned brush-finished upper decorative inserts having bright, black, and silver borders, cloth inserts in armrest area plus carpeting on lower portions. Vinyl-covered color-keyed molded plastic body side trim panels (in rear quarter areas) with carpet trim. Vinyl-covered color-keyed hardboard lower rear door trim panels with carpet trim. (Color-keyed molded plastic tailgate trim panel with carpet trim for models with optional tailgate)
- **Steering Wheel:** Bright trim on horn button
- **Visor Mirror:** On RH sun visor

R/V SUBURBAN REAR DOOR TYPES

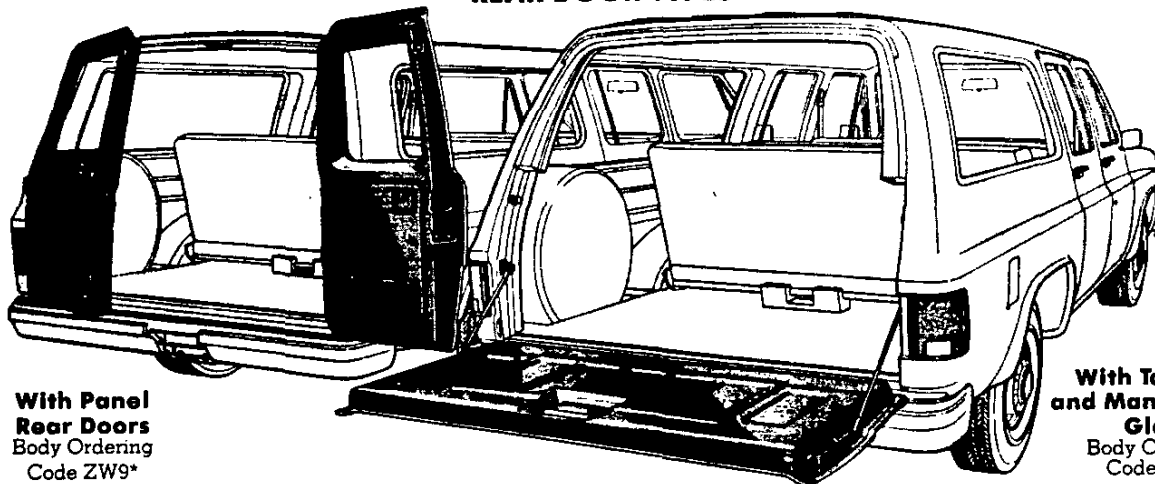

**With Panel
Rear Doors**
Body Ordering
Code ZW9*

**With Tailgate
and Manual Drop
Glass**
Body Ordering
Code E55*

Suburban models have 4 side doors, two front and two rear. Front side doors are equipped with drop-glass and ventipane assemblies; the rear side doors have a drop-glass in the forward portion and fixed glass in the rear portion. The rear quarter windows have fixed glass.

All Suburbans ordered with Body Ordering Code ZW9 have panel-type rear doors incorporating fixed glass, positive fork-cam latches, and an outside key lock. A 2-position, strap-type check on each door permits either a 118- or 162-degree door opening, depending on how the retaining pin is positioned; full door opening of 172-degrees is obtained by removing the retaining pin.

Suburbans ordered with Body Ordering Code E55 have a tailgate with a manually-controlled curved drop glass. Operation of the window is through an articulated crank-type regulator handle on the tailgate outer panel; a key lock cylinder is concealed in the regulator handle, and must be unlocked before the window can be lowered. After the window is lowered, the tailgate can be lowered by moving the release handle at the upper center of the tailgate inner panel. When the tailgate is open, it is supported by reel-type cables. Embossments on the tailgate inner panel facilitate loading of large objects. An optional electric tailgate window is available by ordering RPO A33.

*Both models shown with optional folding center and removable rear seats

CUSTOM OPTIONS

Chromed Bumpers with Rub Strips (RPO VES)



Chromed bumpers with rub strips are available optionally on all Suburban models.

Custom Trim Moldings (RPO B84, B96, YG1)

Body side and rear trim moldings (RPO B84) are black plastic with bright trim and are available for standard Suburban models. They are included in the Custom Molding Package (RPO YG1) for standard and Scottsdale/High Sierra models which also includes bright wheel opening moldings with black paint trim (RPO B96) and bright trim for front side marker lamps and taillamps.

(RPO B85, B96, YG3)

Bright plastic body side and rear moldings with black paint trim (RPO B85) are available for standard and Scottsdale/High Sierra Suburban models. They are included in the Deluxe Molding Package (RPO YG3) which also includes the wheel opening moldings (RPO B96) and other bright lamp trim items described above for RPO YG1.

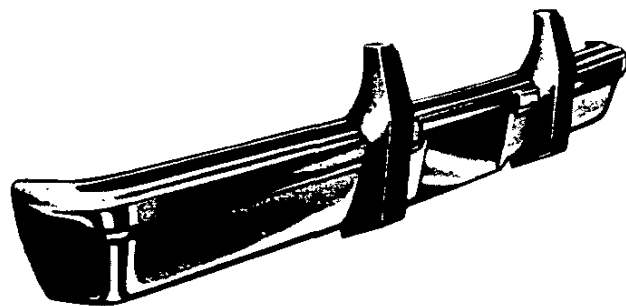

Chromed Front Bumper Guards (RPO V31)

Chromed front bumper guards with rub strips are available optionally on Suburban models. Not available when chromed bumpers with rub strips are ordered.

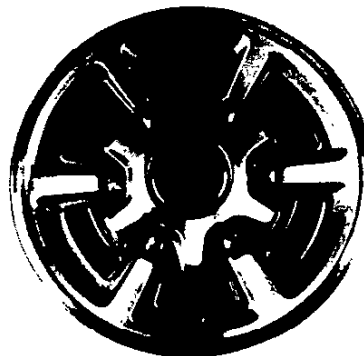

Wheel Covers

Stainless steel wheel covers are available on all Suburban models. The front units for V10/1500-20/2500 models with 4WD have a cut-out at the center to clear the axle hubs.

R/V SUBURBAN

SOLID AND TWO-TONE* EXTERIOR COLOR COMBINATIONS

The application of paint for solid and two-tone exterior color combinations is shown below.

Solid color paint (ZY1) is standard on all models. All painted areas of the body and front end sheet metal are the same color.



GMC model shown (Chevrolet model available)



Chevrolet model shown (GMC model available)

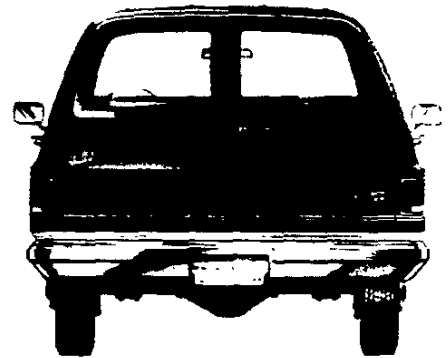

Special two-tone (ZY3) paint colors include the YG1 molding package consisting of black vinyl body side and rear moldings with bright trim, bright wheel opening moldings, and bright trim for front side marker lights and tail lights (except with the YG3 molding package or the Silverado/

Sierra Classic Model Option where bright body side and rear moldings with black paint trim are substituted). Color code 1 is applied to the areas above the moldings (including the roof). Color code 2 is applied to the areas below the moldings.



GMC model shown (Chevrolet model available)

Exterior Decor Package (ZY5) paint colors and trim are available (see Interior and Exterior Color Availability Chart). The package includes the moldings described under Special Two-Tone. In addition, it includes dual-tone body side and rear tape decal striping keyed to the exterior body color. This striping is applied to the front fenders, side doors and body sides and rear a few inches above the styling crease line. The areas above the striping and below the molding are painted color code 1. Color code 2 is used between the striping and the molding. A bright spring-loaded, stand-up type hood ornament is included on gasoline engine models.

*Optional at extra cost.

NOTES

R/V SUBURBAN

DIMENSIONS

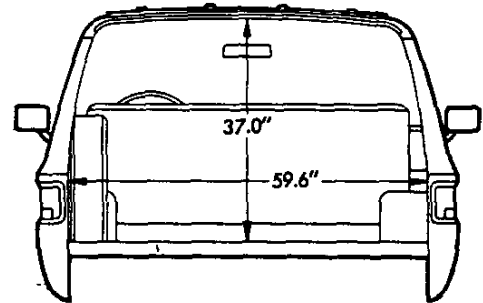
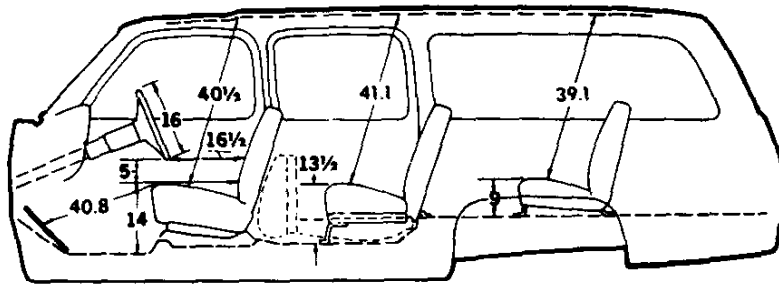

GLASS AREA (Sq. in.)

Windshield..... 1421
 Front side door, including
 ventipane (each side) 470
 Rear side door (each side) 488

Side rear window (each side)... 1074
 Rear:
 ZW9 panel doors (total)..... 654
 E55 tailgate..... 1041

SEATING ARRANGEMENTS

Front Seat
 Standard full-depth foam front seat

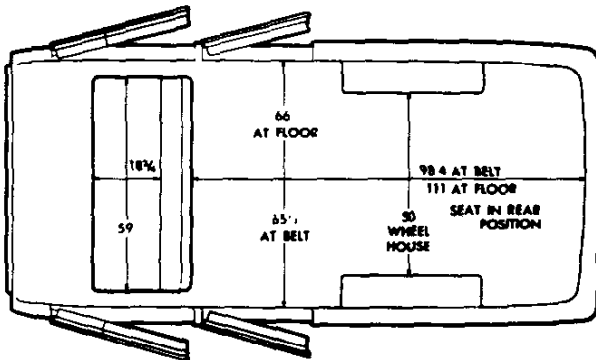

Front and Folding Center Seats
 Standard front and RPO AT5 folding center seats

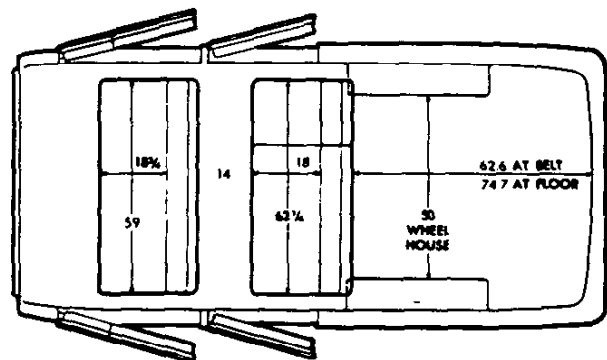

Front and Folding Center Seats
 Standard front and RPO AT5 folding center seats
 (Center seats shown in folded position)

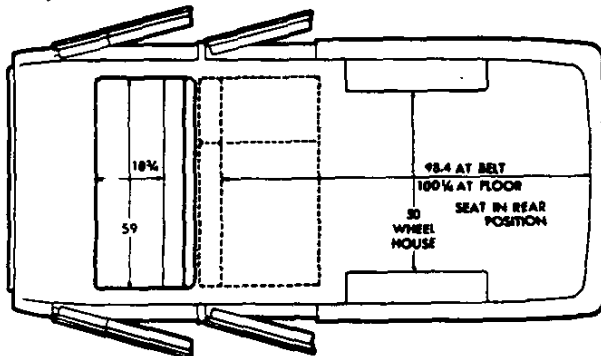

Front, Folding Center and Rear Removable Seats
 Standard front, RPO AT5 folding center and
 RPO AS3 removable rear seats

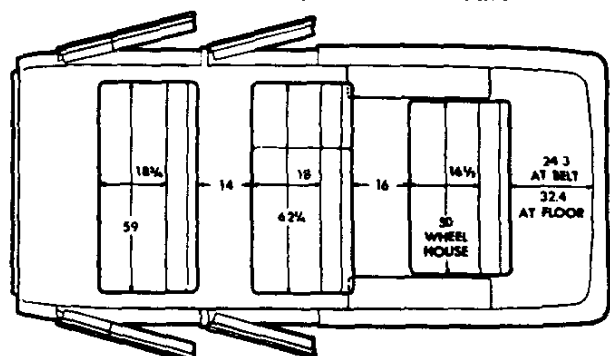

R/V SUBURBAN

INTERIOR AND EXTERIOR COLOR AVAILABILITY CHART

Please Note: Below are the interior trim color and exterior paint combinations recommended by Chevrolet/GMC. The only available color code 1/color code 2 exterior color combinations are those shown in the chart below; however, any available interior trim color may be ordered with one of these exterior color combinations if that particular combination is desired by the customer.

TRIM LEVEL Seat Type	Decor	INTERIOR COLORS				
		Steel	Rangemaster	Saddle Tan	Slate Gray	
CUSTOM DELUXE/SIERRA Vinyl Bench Seat	Std.	VDD1		VSS1		
SCOTTSDALE/HIGH SIERRA Custom Vinyl Bench Seat Custom Cloth Bench Seat	Z62	XDD1 LDD1		XSS1 LSS1		
SILVERADO/SIERRA CLASSIC Custom Vinyl Bench Seat Custom Cloth Bench Seat Custom Vinyl Reclining Bucket Custom Cloth Reclining Bucket	YE9	XDD1 LDD1 XDD6 LDD6	XEE1 LEE1	XSS1 LSS1 XSS6 LSS6	LTT1 LTT6	
EXTERIOR COLORS w/ZY1 or ZY3 PAINT	Color Code 1	Color Code 2	RECOMMENDED INTERIOR TRIM COLOR			
BLACK, MIDNIGHT	19	19		X	X	
Gray, Steel (Metallic)	19	90			X	
Tan, Doeskin	19	61		X		
White, Frost	19	12			X	
BLUE, LIGHT (Metallic)	21	21	X			
Blue, Midnight	21	29	X			
Gray, Steel (Metallic)	21	90	X		X	
White, Frost	21	12	X			
BLUE, MIDNIGHT	29	29	X			
Blue, Light (Metallic)	29	21	X			
Gray, Steel (Metallic)	29	90	X		X	
White, Frost	29	12	X			
BRONZE, INDIAN (Metallic)	66	66		X		
Tan, Doeskin	66	61		X		
White, Frost	66	12		X		
COPPER, CANYON (Metallic)	55	55		X		
Black, Midnight	55	19		X		
Tan, Doeskin	55	61		X		
White, Frost	55	12		X		
GOLD, NEVADA (Metallic)	67	67		X		
Black, Midnight	67	19		X		
Tan, Doeskin	67	61		X		
White, Frost	67	12		X		
GRAY, STEEL (Metallic)	90	90	X	X	X	
Black, Midnight	90	19			X	
Blue, Light (Metallic)	90	21	X			
Blue, Midnight	90	29	X			
Red, Apple	90	72			X	
White, Frost	90	12			X	
RED, APPLE	72	72		X	X	
Gray, Steel (Metallic)	72	90		X		
Tan, Doeskin	72	61		X	X	
White, Frost	72	12		X		
TAN, DOESKIN	61	61		X		
Black, Midnight	61	19		X		
White, Frost	61	12		X		
WHITE, FROST	12	12	X	X	X	
Black, Midnight	12	19		X	X	
Blue, Light (Metallic)	12	21	X			
Blue, Midnight	12	29	X			
Red, Apple	12	72		X	X	
Gray, Steel (Metallic)	12	90		X	X	
Tan, Doeskin	12	61		X	X	
w/ZY5 PAINT (Interior and Exterior Combinations Shown are the Only Combinations Available)						STRIPE COLOR
BLACK, MIDNIGHT/Red, Apple	19	72		X		Vermillion/Black
BLACK, MIDNIGHT/Gray, Steel (Met)	19	90			X	Vermillion/Black
BLACK, MIDNIGHT/Tan, Doeskin	19	61		X		Vermillion/Black
BLACK, MIDNIGHT/White, Frost	19	12			X	Vermillion/Black
BLUE, LIGHT (Met)/Blue, Midnight	21	29	X			Light Blue/Dark Blue
BLUE, LIGHT (Met)/Gray, Steel (Met)	21	90	X		X	Dark Blue/Light Slate
BLUE, LIGHT (Met)/White, Frost	21	12	X			Dark Blue/White
BLUE, MIDNIGHT/Blue, Light (Met)	29	21	X			Light Blue/Dark Blue
BLUE, MIDNIGHT/Gray, Steel (Met)	29	90	X		X	Vermillion/Light Slate
BRONZE, INDIAN (Met)/Tan, Doeskin	66	61		X		Almond/Dark Brown
BRONZE, INDIAN (Met)/White, Frost	66	12		X		Almond/Dark Brown
COPPER, CANYON (Met)/Tan, Doeskin	55	61		X		Dark Brown/Almond
COPPER, CANYON (Met)/White, Frost	55	12		X		Almond/Dark Brown
RED, APPLE/Black, Midnight	72	19		X		Vermillion/Black
RED, APPLE/Gray, Steel (Metallic)	72	90		X		Vermillion/Dark Carmine
RED, APPLE/Tan, Doeskin	72	61		X	X	Vermillion/Black
RED, APPLE/White, Frost	72	12		X		Vermillion/Black
GRAY, STEEL (Met)/Black, Midnight	90	19			X	Vermillion/Black
GRAY, STEEL (Met)/Blue, Light (Met)	90	21	X			Dark Blue/Light Blue
GRAY, STEEL (Met)/Blue, Midnight	90	29	X			Light Blue/Dark Blue
GRAY, STEEL (Met)/Red, Apple	90	72			X	Vermillion/Black
TAN, DOESKIN/Black, Midnight	61	19		X		Vermillion/Dark Carmine
TAN, DOESKIN/Red, Apple	61	72		X		Vermillion/Black