



CHEVY VAN

1



ADVERTISING INFORMATION

CHEVY VAN

EXTERIOR

- One new color is available, Champagne Metallic (Code 62).
- New "Fuel Injection" nameplate for all Chevy Van models is located below the Chevrolet nameplate on the LH rear door.

BODY

- New base seat trim material. This new color-printed vinyl replaces the "basket-weave" vinyl previously used. The new material is more durable.

CHASSIS AND POWER TEAM

- Note: For 1987, all gas engines in Chevy Van with GVWRs of 10,000 lbs. and under will be certified using light-duty emissions test procedure. This will require the use of a catalytic converter and unleaded fuel.
- All gas engines in models 10,000 lbs. GVWR and under will have Electronic Fuel Injection (EFI). The advantages are:
 - Improved fuel control for enhanced cold starting
 - Reduced plug fouling
 - Improved fuel economy
 - Improved drivability under all operating conditions
 - Greater reliability through the use of fewer parts
 - No external adjustments.

THE VORTEC 4.3 LITER V6 ENGINE also features anti-friction roller hydraulic valve lifters for 1987. This new feature helps reduce friction and improve fuel economy.

THE RPO LO3 5.0 LITER (305 CU. IN.) V8 EFI ENGINE is now available nationwide, as well as California. HP and torque are increased by about 6%.

THE 5.7 LITER (350 CU. IN.) V8 EFI ENGINE RPO LO5 is now available nationwide. Horsepower increases about 18% and torque about 4%.

New "serpentine" drive belt replaces the conventional multiple V-belts on all engines with EFI. Benefits are:

- Automatic belt tensioning
- Spring-loaded tensioner
- Less complex system
- 100,000-mile life expectancy.

New Delco Freedom batteries are lighter in weight and feature a newly designed "flat top" case. They provide higher cold cranking amps for all engines except the 6.2 Liter Diesel. The increases are:

Engine	Cold Cranking Amps	
	1986	1987
4.3 Liter V6	500	525
5.0 & 5.7 Liter V8	405	525
H.D. Battery, RPO UA1	540	630

Delcotron generator capacities have also been increased for all gas engine applications. The base capacity increases from 37 amps to 85 amps. Models equipped with air conditioning have 100-amp unit.

OPTIONS

- Custom Vinyl seat-trim fabric.
- Front floor carpeting includes carpet wear pads on the front wheelhousing kickup area for improved durability.
- AM/FM stereo radio/ stereo cassette with Seek and Scan feature and clock.
- Rear compartment combination dome and reading lights with interrupter switch allow doors to remain open with dome lamps off.
- All 15" highway-tread steel-belted radial tires have all-season tread on G10 and G20 models.
- Cast aluminum wheels for stylish appearance. Includes four 15" x 6.5" wheels.
- Trailering: When properly equipped, Chevy Van can move up to 13,500 lbs. (including van, passengers, equipment, cargo and trailer).

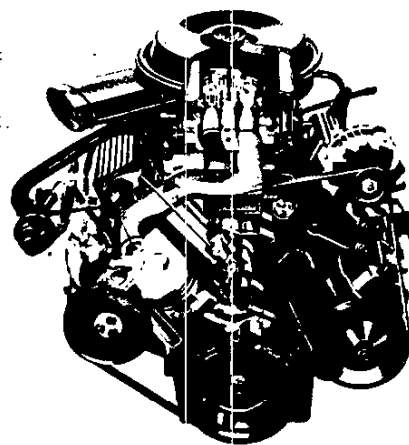

STANDARD VALUE FEATURES

ALL THIS AT NO EXTRA COST:

- "Vortec" 4.3 Liter V6 engine for impressive performance.
- All-season, steel-belted radial ply tires are base equipment on all G10-20 models.
- Wide tread contributes to stable, impressive handling.
- Power steering standard on G20-30.
- Styled for good looks and utility.
- Stylish grille surrounded by headlamp/parking lamp bezels, painted light argent.
- Inside hood release for greater security.
- Windshield washers with nozzles attached to the wiper arms for effective cleaning.
- Custom Vinyl seat-trim fabric, matching passenger seat available.
- Driver seat mounted on extended track for more leg room.
- Large fuse block for easy serviceability.
- Instrument panel extension features an ashtray, handy storage bin and parcel tray.
- Epoxy bonding, instead of spot-welding, joins door inner and outer panels for better appearance.
- G30 Vans with 8,600-lb. GWR have height-sensing rear brake proportioning valve for better braking balance when loaded or unloaded.
- Swing-out side doors with new solid 90° door check available as a no-cost option with or without windows on Chevy Van.
- Right-side sliding door for easy loading. Requires only 4½" of side clearance.
- Front-opening hood permits access to 27 maintenance items.
- High-level air intake for heating/ventilation system.
- Concealed front and side door steps for easy access to cargo or seating area.
- Unitized body construction.
- Wide rear door opening—an impressive 54.4". Opens a full 180° for easy dock loading.
- Chevy 125" wheelbase van has a spacious cargo area—up to 260 cu. ft. of load space, up to 14-ft. maximum load length.
- Fully independent coil-spring front suspension helps minimize road shock and smooth the ride.
- Two-stage multileaf rear springs for easy ride when empty, firm support when fully loaded.
- V8 power available.** For extra power, Chevrolet offers a choice of rugged V8s: The 5.0 Liter (305 Cu. In.) and 5.7 Liter (350 Cu. In.) with Electronic Fuel Injection. The 5.7 Liter (350 Cu. In.) is standard on heavy-duty G30 Chevy Vans.
- 6.2 Liter (379 Cu. In.) V8 Diesel.** L.D. for G20 Series and H.D. for G30 Series. Proven design. Provides impressive torque with diesel efficiency.

IMPROVED ANTI-CORROSION PROTECTION

- Special steels used for selected components to help fight corrosion: two-sided galvanized steel inner and outer hood panels, LH and RH body side door outer panels, body sliding side-door outer panel, sliding side-door upper outer track and cover.
- Anti-chip coating along the lower body and protective coating over front-door hinge pins.
- Sealers help keep moisture from critical joints in wheel-housings, rocker panels and front door. Step panels are sprayed with underbody protective coating.
- Cab and entire underbody are ELPO primed through immersion in an electrically charged primer paint. A positive and negative charge draws paint into hard-to-reach cracks and crevices for corrosion protection.
- Aluminized exhaust system for corrosion protection.



ENGINE VALUE FEATURES

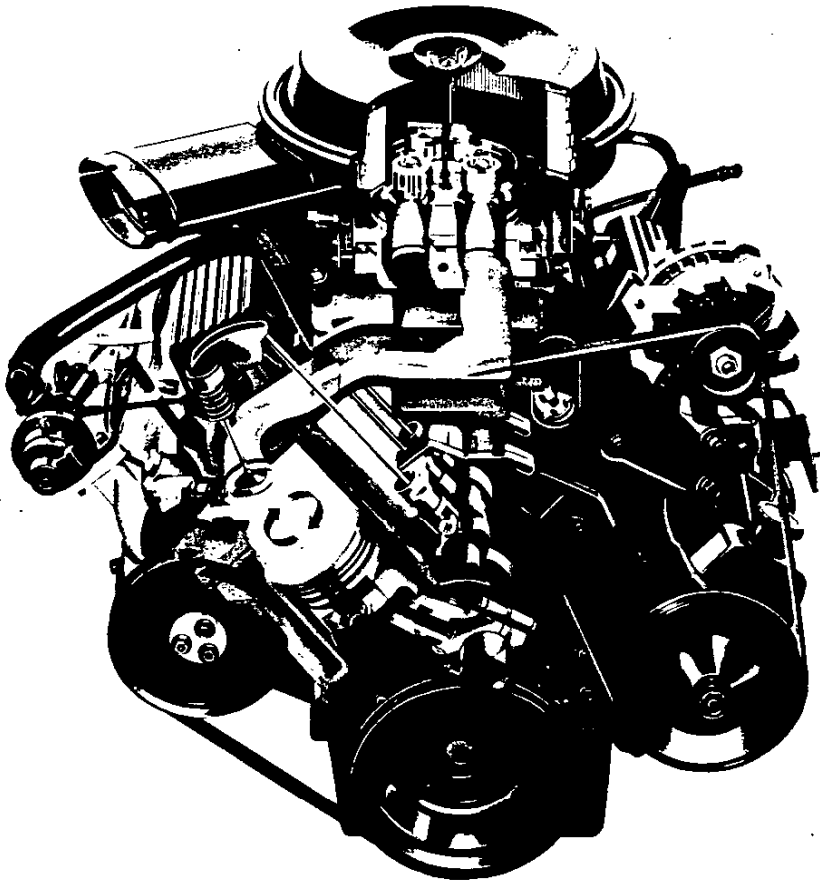

The Vortec 4.3 Liter V6 gas engine is a naturally aspirated 90° V6 with 4-cycle design. Advantages of this engine include:

- Electronic Fuel Injection
- Improved mixing of fuel and air as a result of the swirl-port induction system.
- More complete fuel burning due to the centralized spark plug combustion chamber.
- Volumetric efficiency is the major result of the higher 9.3 to 1 compression ratio. The higher compression ratio is coupled with the Electronic Spark Control (ESC), which controls spark knock. In addition to the above, the 4.3 Liter V6 basic features are:
- Copper-core spark plugs help prevent plug fouling.
- Single-point air injection.
- Even firing results in smooth operation and allows a low idle speed.
- Stone-ground, microfinished crankshaft.
- Tubular stainless steel exhaust manifolds.
- Low-tension oil rings for reduced friction.
- Rocker arm covers fit into a recess in the cylinder heads for better sealing.

CHASSIS VALUE FEATURES

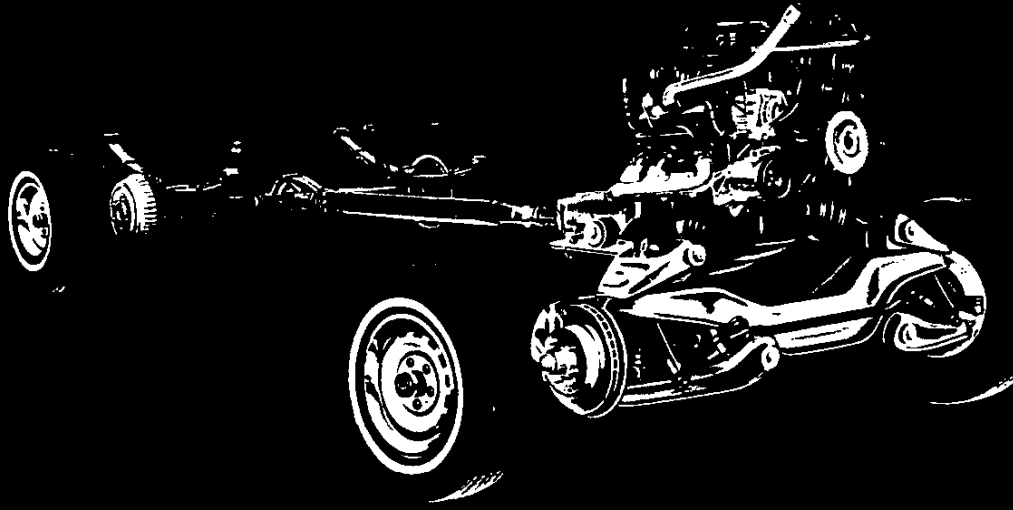

ALUMINIZED EXHAUST SYSTEM

- Coated inside and out to help fight corrosion.
- Special hangers allow for heat expansion.

TRANSMISSIONS

- Floor-mounted, fully synchronized, 3-speed manual transmissions standard in G10 Chevy Vans, G20 gasoline-engine Chevy Vans.
- 4-speed, synchronized manual transmissions with overdrive standard in G20 Chevy Vans with diesel engines.

- 3-speed automatic transmissions standard in G30/C6P Chevy Vans.

FRONT SUSPENSION

- Chevy's rugged girder-beam independent front suspension puts a husky coil spring at each wheel, along with tough suspension members, for a smooth, quiet ride.

REAR AXLES

- 5,700-lb.-capacity Salisbury semi-floating design for G30 models features a 9½" ring gear.
- Locking rear differential, RPO G80, available on all models.
- Two-stage multileaf rear springs automatically adjust to the load.

COUNTER-ANGLED REAR SHOCKS

- Designed to help reduce wheel hop.

BRAKES

Front disc brakes and finned-drum rear brakes are incorporated into complete braking systems, which are computer matched to each model. Audible wear sensors warn of need to replace front brake pads. Semi-metallic front brake linings on G10 and G20, as well as nonasbestos rear linings on most vehicles.

DIMENSIONS AND WINDOWS



AVAILABLE WINDOW COMBINATIONS

Include any or all of the following:

Rear door windows (stationary or swing-out).

Windows on right side only.

Window in sliding door (one-piece fixed or two-piece swing-out) and two-piece swing-out on left side.

Windows all around.

Note: Clear, tinted and deep-tinted glass available for all combinations.

DIMENSIONS (inches)	Chevy Van 110		Chevy Van 125	
	G10	G20	G10	G20
Wheelbase	110.0		125.0	
Overall Length	178.2		202.2	
Overall Width	79.5		79.5	
Back of Seat to Rear Doors at Belt	94.2		118.2	
Back of Seat to Rear Doors at Floor	102.5		126.5	
Back of Engine Housing to Rear Doors at Floor	118.0		142.0	
Maximum Cargo Length at Floor (W/O RH pass. seat)	150.6		174.7	
Distance Between Wheelhousings	53.5		53.5	
Maximum Inside Width at Floor	70.5		70.6	
Maximum Inside Width at Belt	71.9		71.9	
Maximum Inside Height	53.7		53.8	
Rear Door Opening Width	54.4		54.4	
Rear Door Opening Height	48.8		48.8	
Side Door Opening Width	44.2		44.2	
Side Door Opening Height	49.2		49.2	

CHEVY VAN/VANDURA

CHEVY VAN/VANDURA MODEL SELECTOR

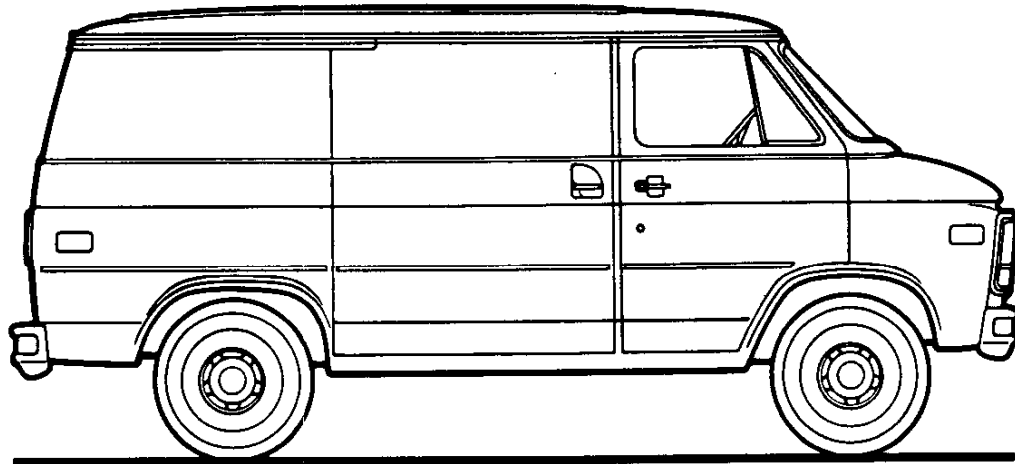

SERIES	MODEL NUMBER		BODY ORDERING CODE	
	110" WB	125" WB	GASOLINE MODELS	DIESEL MODELS
G10/1500	G11005	G11305	ZW9	—
G20/2500	G21005	G21305	ZW9	ZW9/B3J
*G30/3500	—	G31305	ZW9	—
G30/3500/C6P	—	G31305	ZW9/C6P	ZW9/C6P/B3J

*Not available for registration in the State of California.

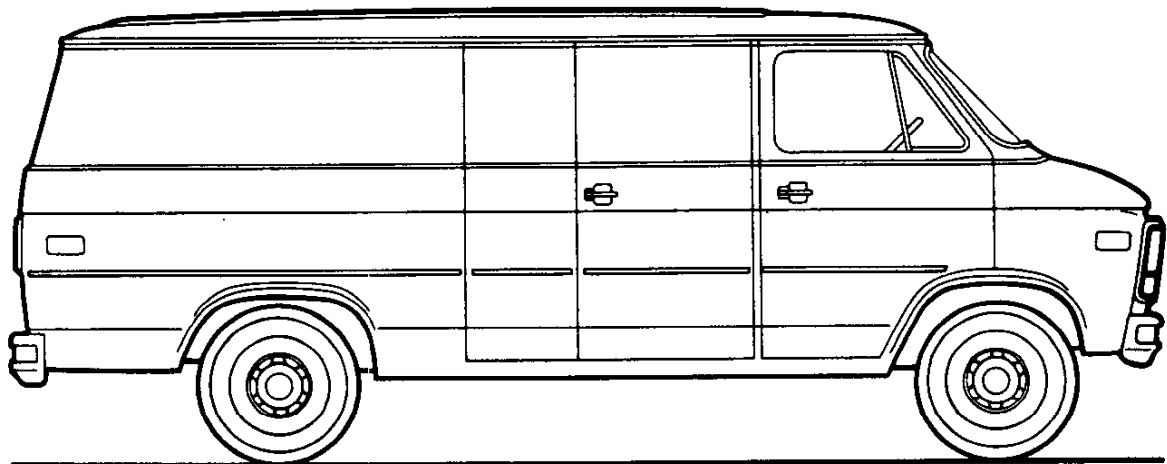

GASOLINE

CHEVY VAN/VANDURA

STANDARD SPECIFICATIONS

(See Gray Tab Section for Specification Details)

Series	G10/1500	G20/2500
Engine	4.3 Liter, 262 EFI V6	
Base Equip.	11"; 124 sq. in.	
Clutch	Oiled-paper Element	
Air Filter	Throwaway Type	
Oil Filter	Single; Aluminized	
Exhaust System		
Emission Control Systems	See Engine & Cooling Section for specific model applications	
Suspension, Front	Independent; Coil Springs	
Capacity	3400 lb.	3400 lb.
Springs @ Ground	1310 lb. ea.	1700 lb. ea.
Shock Absorbers	25mm dia.	25mm dia.
Suspension, Rear	Salisbury Axle; Hypoid Drive; Two-stage Multi-leaf Springs	
Axle Capacity	3500 lb.	3500 lb.
Axle Ratio	3.08	3.42
Springs @ Ground	1200 lb. ea.	1700 lb. ea.
Shock Absorbers	25mm dia.	25mm dia.
Brakes	Hydraulic; Self-adjusting	
Front	Disc; 11.86" Rotor	Disc; 11.86" Rotor
Rear	Drum; 11" x 2"	Drum; 11.15" x 2.75"
Booster	—	Dual Diaphragm
Parking	Cable to Rear Wheels	
Electrical	12 Volt; Negative Ground	
Battery	525 CCA♦ @ 0°F.	
— Freedom Type	90 min. @ 80°F.	
— Reserve Capacity	85 amp.	
Delcotron Generator		
Frame	Integral Body-frame	
Fuel Tank (nominal capacity)	22 gal.	
Steering Gear Type	Manual; Recirculating Ball Gear	Integral Power
Linkage	Parallelogram	
Transmission	Fully Synchronized 3-Speed Manual	
Shift Location	Floor	
Tires	(5) P195/75R15 All Seasons Steel Belted Radial	(4) P225/75R15 All Seasons Steel Belted Radial
Wheels	(5) Disc 15" x 6"	

♦CCA-Cold Cranking Amps

CHEVY VAN/VANDURA



STANDARD SPECIFICATIONS

(See Gray Tab Section for Specification Details)

Series [▲]	★G20/2500
Engine Base Equip. Clutch Air Filter Oil Filter Oil Cooler Exhaust System Emission Control Systems	6.2 Liter, 379 Cu. In. V8 Diesel 12", 150 sq. in. Poly-wrapped, Oiled-paper Element Throwaway Type Standard Dual; Aluminized See Engine & Cooling Section for specific model applications
Suspension, Front Capacity - 110" WB - 125" WB Springs @ Ground - 110" WB - 125" WB Shock Absorbers	Independent; Coil Springs 3500 lb. 3675 lb. 1750 lb. ea. 1835 lb. ea. 25mm dia.
Suspension, Rear Axle Capacity Axle Ratio Springs @ Ground Shock Absorbers	Salisbury Axle; Hypoid Drive; Two-stage Multi-leaf Springs 3500 lb. 3.42 1700 lb. ea. 25mm dia.
Brakes Front Rear Booster Parking	Hydraulic; Self-adjusting Disc; 11.86" Rotor Drum; 11.15" x 2.75" Hydraulic Power Cable to Rear Wheels
Electrical Battery - Freedom Type - Reserve Capacity Delcotron Generator Engine Block Heater	12 Volt; Negative Ground Two; 540 CCA♦ ea. @ 0°F. 115 min. ea. @ 80°F. 66 amp. 600 watts, 120 volts
Frame	Integral Body-frame
Fuel Tank (nominal capacity)	22 gal.
Steering Gear Type	Integral Power
Transmission Shift Location	<i>MM7</i> 4-Speed Automatic w/Overdrive Steering Column <i>STANDARD 4 SPD</i>
Tires	(4) P225/75R15 All Seasons Steel Belted Radial
Wheels	(5) Disc 15" x 6"

▲Note: G10/1500 models not available with diesel engines

★Not available for registration in the State of California

♦CCA-Cold Cranking Amps

Price 2 MM7
Base

GASOLINE

CHEVY VAN/VANDURA

STANDARD SPECIFICATIONS

(See Gray Tab Section for Specification Details)

Series	*G30/3500	G30/3500/G6P
Engine		
Base Equip.	4.3 Liter, 262 EFI V6	5.7 Liter, 350 EFI V8
Air Filter	Oiled-paper Element	
Oil Filter	Throwaway Type	
Exhaust System	Single; Aluminized	*Dual; Stainless Steel
Emission Control Systems	See Engine & Cooling Section for specific model applications	
Suspension, Front	Independent; Coil Springs	
Capacity	3900 lb.	3900 lb.
Springs @ Ground	1700 lb. ea.	1950 lb. ea.
Shock Absorbers	25mm dia.	25mm dia.
Stabilizer Bar	—	1.06" dia.
Suspension, Rear	Salisbury Axle; Hypoid Drive; Two-stage Multi-leaf Springs	
Axle Capacity	5700 lb.	5700 lb.
Axle Ratio	3.73	3.73
Springs @ Ground	2100 lb. ea.	2700 lb. ea.
Shock Absorbers	25mm dia.	25mm dia.
Brakes	Hydraulic; Self-adjusting	
Front	Disc; 12.5" Rotor	Disc; 12.5" Rotor
Rear	Drum; 13" x 2.5"	Drum; 13" x 2.5"
Booster	Dual Diaphragm	Dual Diaphragm
Parking	Cable to Rear Wheels	
Electrical	12 Volt; Negative Ground	
Battery		
— Freedom Type	525 CCA♦ @ 0°F.	
— Reserve Capacity	90 min. @ 80°F.	
Delcotron Generator	85 amp.	
Frame	Integral Body-frame	
Fuel Tank (nominal capacity)	22 gal.	
Steering Gear Type	Integral Power	
Transmission	4-Speed Automatic w/Overdrive	3-Speed Automatic
Shift Location	Steering Column	Steering Column
Tires	(4) 8.75R-16.5C (6PR)	(4) 8.75-16.5E (10PR)
Wheels	(5) Disc 16.5" x 6.75"	(5) Disc 16.5" x 6.75"

*Not available for registration in the State of California

*Single; Aluminized for California

♦CCA-Cold Cranking Amps

CHEVY VAN/VANDURA

DIESEL

STANDARD SPECIFICATIONS

(See Gray Tab Section for Specification Details)

Series▲	G30/3500/C6P
Engine	6.2 Liter, 379 Cu. In. V8 Diesel
Base Equip.	Poly-wrapped, Oiled-paper Element
Air Filter	Throwaway Type
Oil Filter	Standard
Oil Cooler	Dual; Aluminized
Exhaust System	
Emission Control Systems	See Engine & Cooling Section for specific model applications
Suspension, Front	Independent; Coil Springs
Capacity	3900 lb.
Springs @ Ground	1950 lb. ea.
Shock Absorbers	25mm dia.
Stabilizer Bar	1.06" dia.
Suspension, Rear	Salisbury Axle; Hypoid Drive; Two-stage Multi-leaf Springs
Axle Capacity	5700 lb.
Axle Ratio	3.73
Springs, @ Ground	2700 lb. ea.
Shock Absorbers	25mm dia.
Brakes	Hydraulic; Self-adjusting
Front	Disc; 12.5" Rotor
Rear	Drum; 13" x 2.5"
Booster	Hydraulic Power
Parking	Cable to Rear Wheels
Electrical	12 Volt; Negative Ground
Battery	
- Freedom Type	Two; 540 CCA♦ ea. @ 0°F.
- Reserve Capacity	115 min. ea. @ 80°F.
Delcotron Generator	66 amp.
Engine Block Heater	600 watts, 120 volts
Frame	Integral Body-frame
Fuel Tank (nominal capacity)	22 gal.
Steering Gear Type	Integral Power
Transmission	3-Speed Automatic
Shift Location	Steering Column
Tires	(4) 8.75-16.5E (10PR)
Wheels	(5) Disc 16.5" x 6.75"

▲Note: G30/3500 models without C6P not available with diesel engine.

♦CCA-Cold Cranking Amps

GASOLINE

CHEVY VAN/VANDURA

Body Ordering Codes:
Chevy Van/Vandura—ZW9

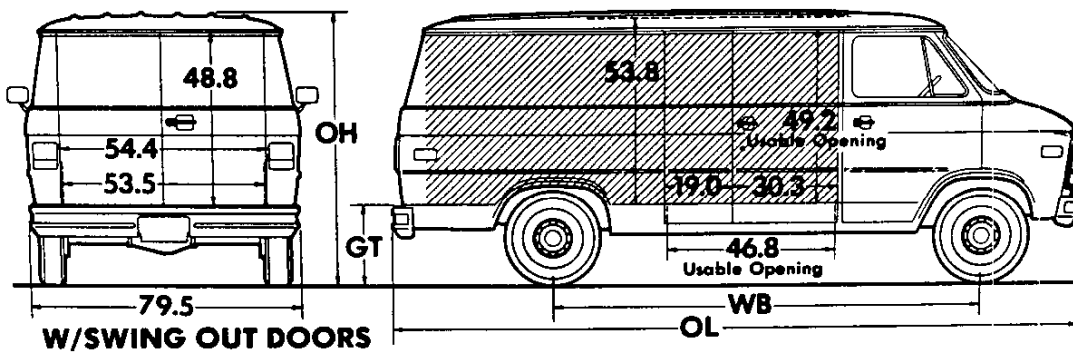
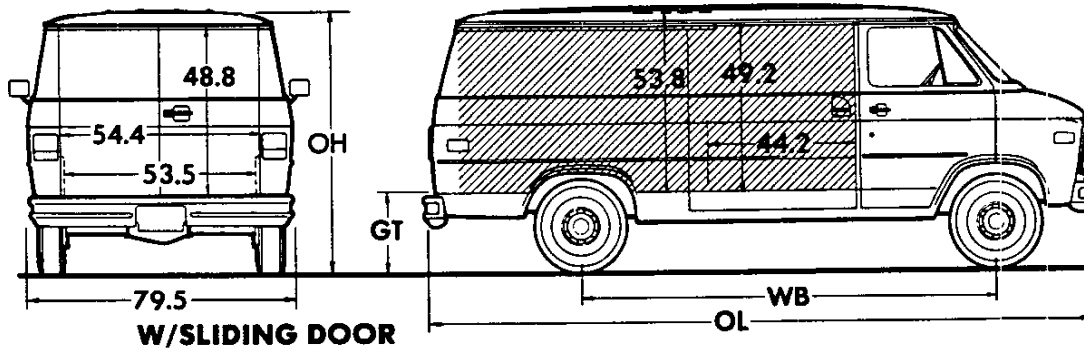

Side slide-in opening clearance 44.2" with sliding door; 46.8" with swing out doors; max. box cargo height 49.2" with standard front passenger seat.

Rear slide-in opening clearance 52" with spare tire in position or 53.5" with spare tire removed; height 48.8".

Sign Panel Area (side)

110" WB—51¼" x 94"
125" WB—51¼" x 118¼"

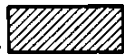

Capacity (cu ft)

110" WB—207
125" WB—260

Series	Ground Clearance (in)*	
	Front	Rear
G1	6.3	6.7
G2	7.3	7.3
G3	9.0	7.0

Model	Engine No. Cyl.	Dimensions (in)*				Curb Weight (lb)			Model Weight (lb)*		
		WB	OL	OH	GT	Front	Rear	Total	Front	Rear	Total

G10/1500 SERIES

G11005	6	110	178.2	79.4	25.0	2080	1586	3666	2186	1630	3816
G11305	6	125	202.2	79.2	24.6	2129	1676	3805	2240	1715	3955

G20/2500 SERIES

G21005	6	110	178.2	79.8	25.4	2140	1614	3754	2246	1658	3904
G21305	6	125	202.2	79.5	25.4	2188	1705	3893	2299	1744	4043

G30/3500 SERIES

G31305Δ	6	125	202.2	81.9	28.0	2473	1963	4436	2584	2002	4586
G31305 (W/C6P)	8	125	202.2	81.9	28.0	2473	1963	4436	2584	2002	4586

*Dimensions with standard equipment, unloaded.

*Model Weight includes Curb Weight plus occupants (standard seating capacity x 150 lb). Total Model Weight may vary as much as ±50 lbs. to allow for production build variation.

Δ Not available for registration in the State of California.

CHEVY VAN/VANDURA

Body Ordering Codes:
Chevy Van/Vandura--ZW9/B3J

DIESEL

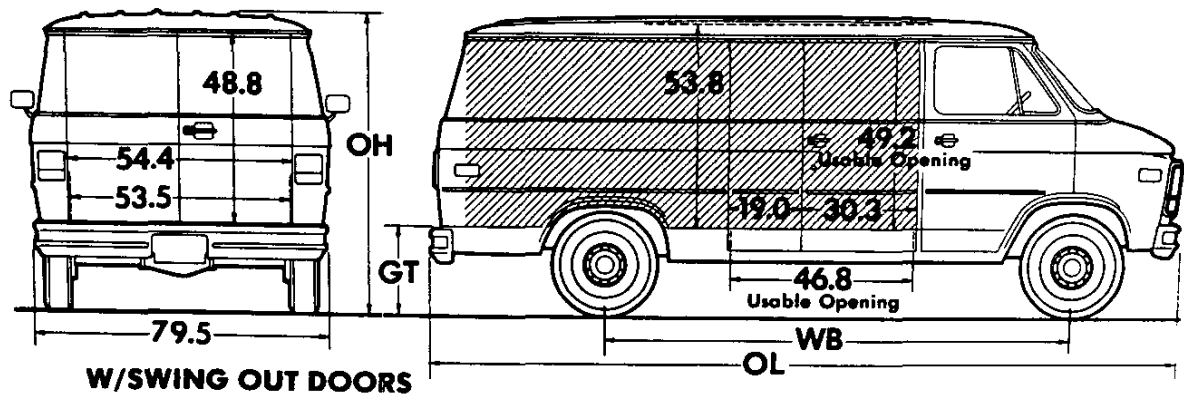
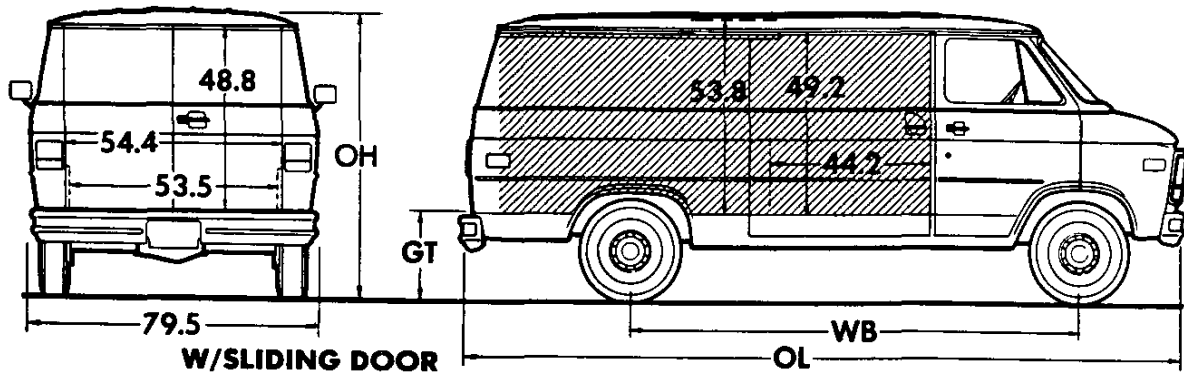

Side slide-in opening clearance 44.2" with sliding door; 46.8" with swing out doors; max. box cargo height 49.2" with standard front passenger seat.

Rear slide-in opening clearance 52" with spare tire in position or 53.5" with spare tire removed; height 48.8"

Sign Panel Area (side)

110" WB - 51 1/4" x 94"
125" WB - 51 1/4" x 118 1/4"



Capacity (cu ft)

110" WB - 207
125" WB - 280

Series	Ground Clearance (in)*	
	Front	Rear
G2	7.3	7.3
G3	9.0	7.0

Model	Engine No. Cyl.	Dimensions (in)*				Curb Weight (lb)			Model Weight (lb)*		
		WB	OL	OH	GT	Front	Rear	Total	Front	Rear	Total

G20/2500 SERIES

G21005	8	110	178.2	79.8	25.4	2546	1684	4230	2652	1728	4380
G21305	8	125	202.2	79.5	25.4	2600	1777	4377	2711	1816	4527

G30/3500 SERIES

G31305 (W/C6P)	8	125	202.2	81.9	28.0	2734	1977	4711	2845	2016	4861
-----------------------	---	-----	-------	------	------	------	------	------	------	------	------

*Dimensions with standard equipment, unloaded.

*Model Weight includes Curb Weight plus occupants (standard seating capacity x 150 lb). Total Model Weight may vary as much as ±50 lbs. to allow for production build variation.

CHEVY VAN/VANDURA
POWER TEAMS
ALL STATES EXCEPT CALIFORNIA
G10/1500 SERIES

POWER TEAMS (MUST ORDER ENGINE, TRANSMISSION AND REAR AXLE)
 (Consult GVWR Selector and Tire Chart to insure tire capacity and availability)

ENGINE	TRANSMISSION				AXLES				GVWR
	3-SP	4-SP	AUTO		3.08	3.42	3.73		
W/NA5 STANDARD EMISSION EQUIPMENT									
LB4 V6 4.3 Liter EFI	MM3		MX0	—	*GQ1	*GT4			ALL
			MX1	GQ1	GU6	—			4900
			MX1	#GQ1	GU6	—			4900
	MM3		MX0	#GQ1	GU6	—			5350/5600
			MX1	#GQ1	*GU6	—			5350/5600
			MX1	—	GQ1	—			6000
L03 V8 5.0 Liter EFI	MM3	MM7	MX0/1	GQ1	GU6	—			6000
			MX0/1	GQ1	GU6	—			4900
			MX0/1	—	GQ1	—			ALL
		MX0/1	#GQ1	GU6	—			5350/5600	
		MX0/1	GQ1	GU6	—			6000	
W/NA6 HIGH ALTITUDE EMISSION EQUIPMENT									
LB4 V6 4.3 Liter EFI	MM3		MX0	—	*GQ1	*GT4			ALL
			MX1	—	GQ1	—			ALL
			MX1	—	*GQ1	—			ALL
L03 V8 5.0 Liter EFI	MM3	MM7	MX0	—	GQ1	—			ALL
			MX0	GQ1	GU6	—			4900
			MX1	—	GQ1	GT4			ALL
			MX0	#GQ1	GU6	—			5350/5600
			MX0	—	GQ1	—			6000

#With G80 Locking Differential Reqs J55 Brakes
 *Reqs KC4 Cooling

CALIFORNIA ONLY
G10/1500 SERIES

ENGINE	TRANSMISSION				AXLES				GVWR
	3-SP	4-SP	AUTO		2.73	3.08	3.42	3.73	
W/YF5 CALIFORNIA EMISSION REQUIREMENTS									
LB4 V6 4.3 Liter EFI	MM3				GQ1	GU6	—		4900
			MX0	—	*GQ1	*GT4			4900
			MX0	#GQ1	GU6	—			5350/5600
	MM3		MX0	—	*GQ1	*GT4			5350/5600
			MX0	—	GQ1	—			6000
			MX0	—	—	*GQ1	—		6000
L03 V8 5.0 Liter EFI			MX0	GQ1	—	—			4900
			MX0	#GQ1	—	—			5350
			MX0	#GQ1	—	—			5600
			MX0	GQ1	—	—			6000
			MX0	GQ1	—	—			6000

#With G80 Locking Differential Reqs J55 Brakes
 *Reqs KC4 Cooling

CHEVY VAN/VANDURA

POWER TEAMS

ALL STATES EXCEPT CALIFORNIA

G20/2500 SERIES

POWER TEAMS (MUST ORDER ENGINE, TRANSMISSION AND REAR AXLE)

(Consult GVWR Selector and Tire Chart to insure tire capacity and availability)

ENGINE	TRANSMISSION			AXLES				GVWR
	3-SP	4-SP	AUTO	2.73	3.08	3.42	3.73	
W/NA5 STANDARD EMISSION EQUIPMENT								
LB4 V6 4.3 Liter EFI	MM3		MX0	—	—	#GQ1	%GT4	6600
			MX1	—	—	GQ1	—	6600
L03 V8 5.0 Liter EFI	MM7		MX1	—	GQ1	#GU6	—	6600
			MX0	—	GQ1	GU6	#GT4	6600
				—	—	GQ1	@GT4	6600
*L05 V8 5.7 Liter EFI			MX0	GQ1	GU4	—	#GT4	6600
LH6 Diesel 6.2 Liter V8 (379 Cu In)(Reqs B3J)	MM7		MX0	—	GQ1	GU6	#GT4	6600
				—	—	GQ1	—	6600
W/NA6 HIGH ALTITUDE EMISSION EQUIPMENT								
LB4 V6 4.3 Liter EFI	MM3		MX0	—	—	#GQ1	%GT4	6600
			MX1	—	—	GQ1	—	6600
L03 V8 5.0 Liter EFI	MM7		MX1	—	GQ1	GU6	—	6600
			MX0	—	—	GQ1	@GT4	6600
				—	—	GQ1	@GT4	6600
*L05 V8 5.7 Liter EFI			MX0	—	GQ1	GU6	#GT4	6600
LH6 Diesel 6.2 Liter V8 (379 Cu In)(Reqs B3J)	MM7		MX0	—	—	GQ1	#GT4	6600
				—	—	GQ1	—	6600

*Reqs Z82 Trailing Special; N/A G80 Locking Differential. #Reqs KC4 Cooling @N/A G80 Locking Differential
 %N/A G80 Locking Differential; Reqs KC4 Cooling. *G21305 Only

G30/3500 SERIES

ENGINE	TRANSMISSION			AXLES		GVWR
		AUTO		3.73	4.10	
W/NA5 STANDARD OR NA6 HIGH ALTITUDE EMISSION EQUIPMENT						
LB4 V6 4.3 Liter EFI (N/A C6P)		MX0		GQ1	—	7100
*L05 V8 5.7 Liter EFI (Reqs C6P)		MX1		GQ1	GT5	8600
■ LL4 Diesel 6.2 Liter V8 (379 Cu In) (Reqs C6P and B3J)		MX1		GQ1	GT5	8600

■ High Altitude Emission Equipment (FOR EXHAUST SMOKE REDUCTION PURPOSES AT HIGH ALTITUDE; NOT REQUIRED TO SATISFY HIGH ALTITUDE EMISSION REGULATIONS). (REQS. LL4 ENG)
 *N/A NA6 High Altitude Emission. With NA5 Standard Emission Satisfies High Altitude Emission Requirements.

CALIFORNIA ONLY

G20/2500 SERIES

ENGINE	TRANSMISSION			AXLES				GVWR
	3-SP		AUTO	2.73	3.08	3.42	3.73	
W/YF5 CALIFORNIA EMISSION REQUIREMENTS								
LB4 V6 4.3 Liter EFI	MM3		MX0	—	—	GQ1	—	6600
			MX0	—	—	#GQ1	%GT4	6600
L03 V8 5.0 Liter EFI			MX0	—	GQ1	—	—	6600
*L05 V8 5.7 Liter EFI			MX0	GQ1	GU4	—	#GT4	6600

*Reqs Z82 Trailing Special; N/A G80 Locking Differential. #Reqs KC4 Cooling
 %N/A G80 Locking Differential; Reqs KC4 Cooling. *G21305 Only

G30/3500 SERIES

ENGINE	TRANSMISSION			AXLES		GVW
		AUTO		3.73	4.10	
W/YF5 CALIFORNIA EMISSION REQUIREMENTS						
L05 V8 5.7 Liter EFI (Reqs C6P)		MX1		GQ1	GT5	8600
LL4 Diesel 6.2 Liter V8 (379 Cu In) (Reqs C6P and B3J)		MX1		GQ1	GT5	8600

CHEVY VAN/VANDURA GVWR SELECTOR—ALL STATES

G10/1500 SERIES

GVW Rating (lbs)	†GAWR (lbs)		Minimum Equipment Required for GVW Rating		
			Tire Capacity (lbs ea)		Chassis Equipment
	Front	Rear	Front	Rear	
4900	2620	2400	1342	1342	Standard
5350	2684	2684	1342	1342	HD Front Springs (F60); HD Rear Springs (G50); Power Brakes (J50); Power Steering (N40)
5600	2906	2906	1453	1453	
6000	3166	3166	1583	1583	HD Front Springs (F60); HD Rear Springs (G50); HD Power Brakes (J55); Power Steering (N40)

†GAWR's shown are the maximum for each axle with equipment listed. Other GAWR's are available, and they are determined as the minimum capacity of either axle, springs or tires.

FRONT AND REAR TIRE AVAILABILITY CHART—ALL STATES

G10/1500 SERIES

Spare tire to match either front or rear tires must be ordered

Description	Capacity (lbs ea)	Highway		On-Off Road	Spare
		Front	Rear	Rear	
TUBELESS					
P195/75R15 Steel Belted Radial	1342	XAR	YAR	—	ZAR
#P205/75R15 Steel Belted Radial	1453	XCE	YCE	— YJT	ZCE ZJT
#P205/75R15 Whitewall Steel Belted Radial	1453	XCG	YCG	—	ZCG
#P205/75R15 White Letter Steel Belted Radial	1453	XCF	YCF	—	ZCF
#P215/75R15 Steel Belted Radial	1583	XCU	YCU	—	ZCU
#P215/75R15 Whitewall Steel Belted Radial	1583	XCV	YCV	—	ZCV
#P215/75R15 White Letter Steel Belted Radial	1583	XCW	YCW	—	ZCW

#Requires Power Steering (N40).

ENGINE RATINGS

ALL STATES

SAE Net Ratings	*4.3 Liter 262 EFI V6	*5.0 Liter 305 EFI V8	*5.7 Liter 350 EFI V8
Net Horsepower	150 @ 4000 rpm	170 @ 4000 rpm	195 @ 4000 rpm
Net Torque, lb-ft	230 @ 2400 rpm	255 @ 2400 rpm	290 @ 2800 rpm

SAE Net Ratings	**5.7 Liter 350 EFI V8	*6.2 Liter 379 V8 Diesel	**6.2 Liter 379 V8 Diesel
Net Horsepower	185 @ 4000 rpm	130 @ 3600 rpm	145 @ 3600 rpm
Net Torque, lb-ft	295 @ 2400 rpm	240 @ 2000 rpm	243 @ 2000 rpm

*Models with GVWR up to 8500 lbs.

**Models with GVWR of 8501 lbs and above.

CHEVY VAN/VANDURA

GVWR SELECTOR—ALL STATES

G20/2500 SERIES

GVWR Rating (lbs)	†GAWR (lbs)		Minimum Equipment Required for GVWR Rating		
	Front	Rear	Tire Capacity (lbs ea)		Chassis Equipment
			Front	Rear	
6600	3400	3400	1703	1703	Standard (Gasoline Models)
	*3500	3400	1843	1843	Standard (Diesel Models)

†GAWR's shown are the maximum for each axle with equipment listed. Other GAWR's are available, and they are determined as the minimum capacity of either axle, springs or tires.

*Front GAWR is 3670 on G21305 model.

FRONT AND REAR TIRE AVAILABILITY CHART—ALL STATES

G20/2500 SERIES

Spare tire to match either front or rear tires is available at extra cost

Description	Capacity (lbs each)	Highway		Spare
		Front	Rear	
TUBELESS (With LB4, L03 or L05 Engine)				
P225/75R15 Steel Belted Radial	1703	XET	YET	ZET
P225/75R15 Whitewall Steel Belted Radial	1703	XEU	YEU	ZEU
P225/75R15 White Letter Steel Belted Radial	1703	XEV	YEV	ZEV
TUBELESS (With LH6 Engine)				
P235/75R15 Steel Belted Radial	1843	XFL	YFL	ZFL
P235/75R15 Whitewall Steel Belted Radial	1843	XFM	YFM	ZFM
P235/75R15 White Letter Steel Belted Radial	1843	XFN	YFN	ZFN

GVWR SELECTOR—ALL STATES EXCEPT CALIFORNIA

G30/3500 SERIES

GVWR Rating (lbs)	†GAWR (lbs)		Minimum Equipment Required for GVWR Rating		
	Front	Rear	Tire Capacity (lbs ea)		Chassis Equipment
			Front	Rear	
▲7100	3400	3980	1990	1990	Standard

▲Requires LB4 V6 engine.

GVWR SELECTOR—ALL STATES

G30/3500/C6P SERIES

GVWR Rating (lbs)	†GAWR (lbs)		Minimum Equipment Required for GVWR Rating		
	Front	Rear	Tire Capacity (lbs ea)		Chassis Equipment
			Front	Rear	
8600	3900	5360	2680	2680	Standard

†GAWR's shown are the maximum for each axle with equipment listed. Other GAWR's are available, and they are determined as the minimum capacity of either axle, springs or tires.

FRONT AND REAR TIRE AVAILABILITY CHART—ALL STATES

G30/3500 SERIES

Spare tire to match either front or rear tires is available at extra cost

Description	Capacity (lbs each)	Highway		Spare
		Front	Rear	
TUBELESS (With LB4 Engine)				
8.75R-16.9C Steel Belted Radial	1990	XWU	YWU	ZWU
TUBELESS (With L05 or LL4 Engine)				
8.75-16.5E Nylon Bias Ply	2680	XTH	YTH	ZTH
8.75R-16.5E Steel Belted Radial	2680	XVD	YVD	ZVD

CHEVY VAN/VANDURA

THE FOLLOWING EQUIPMENT IS STANDARD ON DIESEL ENGINE MODELS (ALSO SEE STANDARD SPECIFICATIONS PAGES)

- Low Coolant Sensor
- Poly-wrapped Paper Element Air Cleaner
- Power Steering
- Engine Block Heater (600 watts, 120 volts)
- Water/fuel separator unit which incorporates a water sensor and sending unit, a fuel filter, a fuel heater and water drain capability
- Hydraulic Power-assisted Brakes
- K81 66-amp Generator
- Engine Oil Cooler (located in radiator tank)
- Dual 540 Cold Cranking Amp/115 min. Reserve Capacity Batteries
- HD Radiator
- Dual Exhaust System
- Warning Lights: Glow Plugs, Water-in-fuel (or fuel filter), and Low Coolant
- Diesel Engine Identification:
 - Fender nameplates
 - LH rear door nameplate
 - "Diesel fuel only" filler cap and label
- Additional Insulation:
 - Fiberglass/aluminum engine cover and engine cover extension insulators
 - Special mastic/fibre front floor insulators
 - Front floor mats which extend under seats
 - Interior compartment dash panel insulation
 - Engine compartment dash panel insulation
 - Hush panels under instrument panel
 - Engine hood insulation
 - Special rubber seal at cowl

CHEVY VAN/VANDURA

**CAB & BODY FEATURES
BODY CONSTRUCTION
SEATING ARRANGEMENTS
COLOR & TRIM CHARTS
TWO-TONES**

CHEVY VAN/VANDURA

STANDARD MODEL—BODY ORDERING CODE—ZW9

The standard model includes the following items as standard equipment

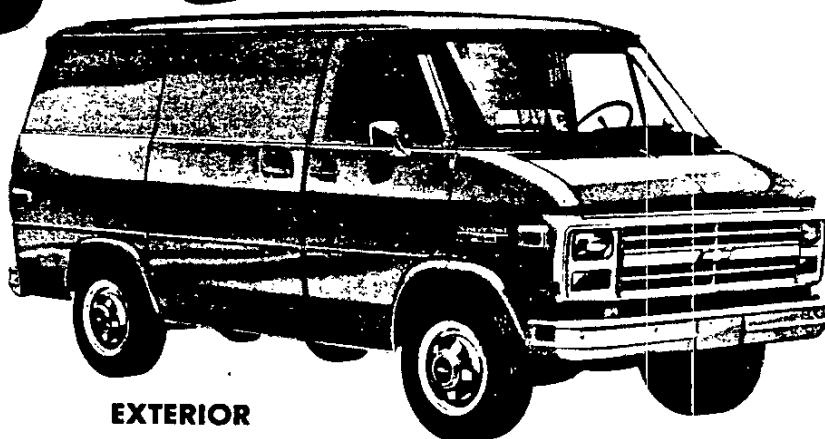
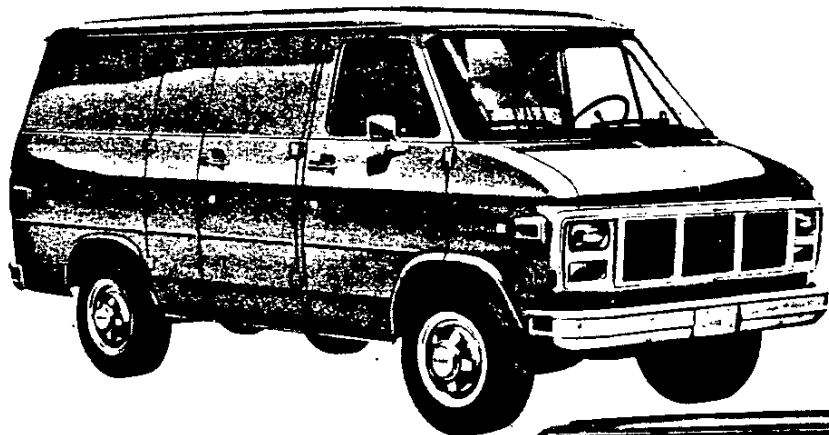

EXTERIOR

- **Bumpers:** Front and rear, painted silver
- **Colors:** See Interior and Exterior Color Selection Chart
- **Doors:** RH and LH front side doors; RH and LH rear load doors; a RH sliding side load door is standard, however, hinged RH side loading doors are available
- **Door Opening and Locking Methods:**
Front side doors: Outside pushbutton latch release in door handle with separate key lock; keyless outside locking
Sliding side load door: turning outside handle counterclockwise releases both front and rear latches; to close door, reverse procedure; for opening and closing of door from inside, reverse outside procedure; door is locked from outside through a separate key lock
RH and LH rear doors: Pushbutton latch release in RH door handle opens door, and after opening RH door, LH door latch is released by lower inside lift handle; separate key lock cylinder in RH door
- **Glass:** Windshield; RH and LH front side door drop glass and pivoting ventpanes
- **Grille:** Molded plastic; painted light argent; integral Chevrolet emblem/GMC letters at center
- **Grille Frame:** Headlamp/parking lamp bezels plus upper and lower moldings joining extensions of lamp bezels; painted light argent
- **Horn:** Single, electric low-note
- **Hub Caps:** Bright metal with black trim
- **Keys:** Two-key system with separate keys for ignition switch and doors and tailgate
- **Lights:**
Backup lamps: Two rear (integral with taillamps)
Combination parking/direction/hazard: Two front
Combination tail/stop/direction/hazard: Two rear
Headlamps: Two; Rectangular
License plate lamp: Single rear
Side marker lamps with reflectors: Two front and two rear
- **Mirrors:** RH and LH chrome; fixed arm with adjustable 6" wide x 4⁹/₁₆" high head

- **Nameplates:** Bright "Chevy Van/Vandura/Series" plate on front fenders; bright "Chevrolet/GMC letters" plate on LH rear door
- **Tools:** Mechanical jack and wheel wrench
- **Undercoating:** On body rocker panels, step panels, wheel-housings
- **Wheels:** Painted white
- **Windshield Wipers and Washers:** Electric, 2-speed wipers with black finish on exposed metal portions; wet-arm design demand-type washer system

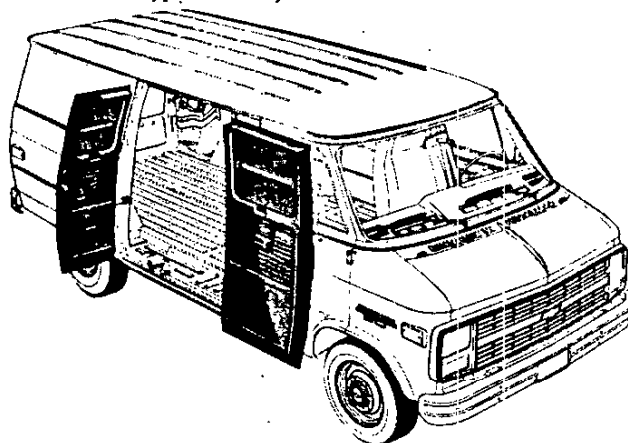

SIDE SWING OUT DOORS—RPO E24

These hinged double side doors are available at no extra cost to replace the standard sliding side door. They feature stainless steel hinge pins and galvanized steel outer panels. The forward door is approximately 12 inches wider than the rearward door to provide a wide opening for cargo or passengers when only the forward door is opened.

CHEVY VAN/VANDURA

STANDARD MODEL—BODY ORDERING CODE—ZW9

The standard model includes the following items as standard equipment

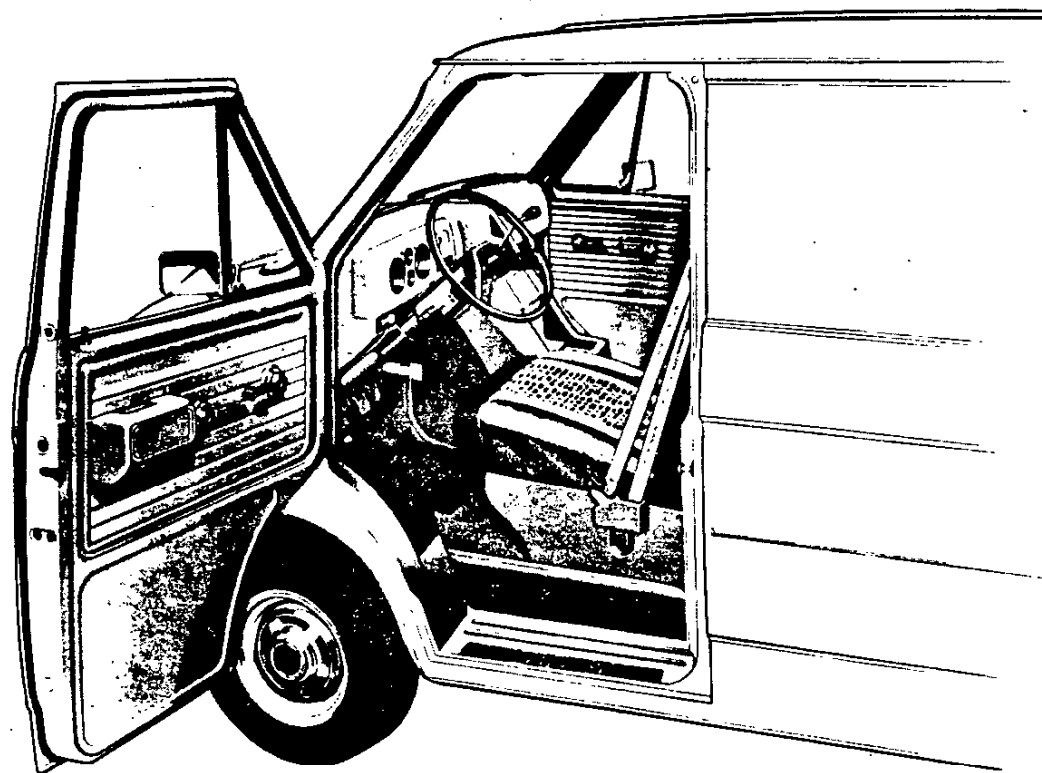

INTERIOR

- **Air Vents:** RH and LH; individually controlled
- **Armrest:** LH side door; padded
- **Ashtray:** At top of instrument panel extension; with door
- **Coat Hooks:** On LH side panel to rear of driver's seat
- **Colors:**
 - Painted areas: Same as exterior primary color choice
 - Interior trim: Coordinated with seat trim color choice
- **Dome Lamps:** Two; with front door-actuated switches (dome lamps may also be activated by main light switch)
- **Door Locks:** Inside pushbutton lock/release for front doors; rotating locking knob for sliding side door
- **Door Seals:** Latex foam rubber
- **Floor Covering:** Embossed black rubber mats, LH front floor area and wheelhousing
- **Headliner:** Mystic-colored perforated hardboard; driver area
- **Heater and Defogger:** Deluxe-air
- **Hood Lock Release:** Handle located on LH side of instrument panel
- **Instruments:**
 - Gages: Speedometer, odometer, and fuel
 - Switches: Main, for control of exterior lights, instrument lights and dome lights; multi-function switch on steering column for direction signals by moving lever up or down (includes lane change position), headlight beams by pulling lever toward driver, windshield wiper by turning band marked "WIPER" toward or away from driver, and windshield washer by pushing in the lever knob; ignition with key-in warning buzzer; hazard warning; heater fan; door-operated dome lamp
 - Warning lights: Generator, oil pressure, engine temperature, service-parking brake, direction/hazard signal, and high beam
- **Instrument Panel:** Bright trim on gauge bezels; black applique with bright trim on area below instrument cluster
- **Insulation and Sound Deadening Material:** Dash (fire-wall), LH front floor panel, engine cover front extension and inside engine cover
- **Lights:** Instruments, front and rear dome
- **Main Light Switch Control Knob:** Bright, with brushed finish and black graphic identification
- **Parcel Tray:** On top surface of instrument panel extension; includes beverage holder provisions
- **Safety Step Pads:** Front and rear side door step panels
- **Seat:** Front, bucket driver; adjustable; all-vinyl trim; foam padded. Also available at extra cost: High back driver and passenger seats in standard vinyl or Custom vinyl. See Interior and Exterior Color Selection Chart for color and trim availability
- **Seat Belt:** Color-keyed with pushbutton release and outboard retractor
- **Spare Tire Carrier:** RH rear side
- **Steering Wheel and Column:** 15.25" diameter black soft vinyl wheel with 2 spokes; black energy-absorbing steering column with anti-theft locking feature
- **Stowage Box:** In front face of instrument panel extension; with latched door
- **Sunshade:** LH padded, color-keyed
- **Trim Panels:** Painted metal with decorative embossments; front and rear side doors

CHEVY VAN/VANDURA

BODY GLASS COMBINATIONS

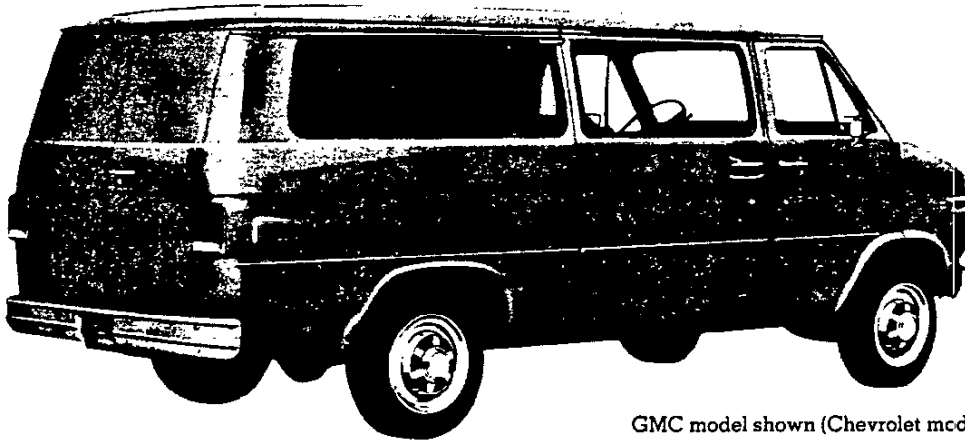

GMC model shown (Chevrolet model available)

2-WINDOW RH BODYSIDE GLASS (RPO A08)

Two-window glass for RH side of vehicle only. Windows with fixed glass provided in RH rear-quarter panel and in side cargo door(s). Included in 6-Window Body Glass (RPO A07).

FIXED SIDE DOOR GLASS (RPO A13)

A single large fixed glass in the RH sliding cargo door or a single fixed glass in each hinged side cargo door. Included with 2-Window Body Glass (RPO A08).

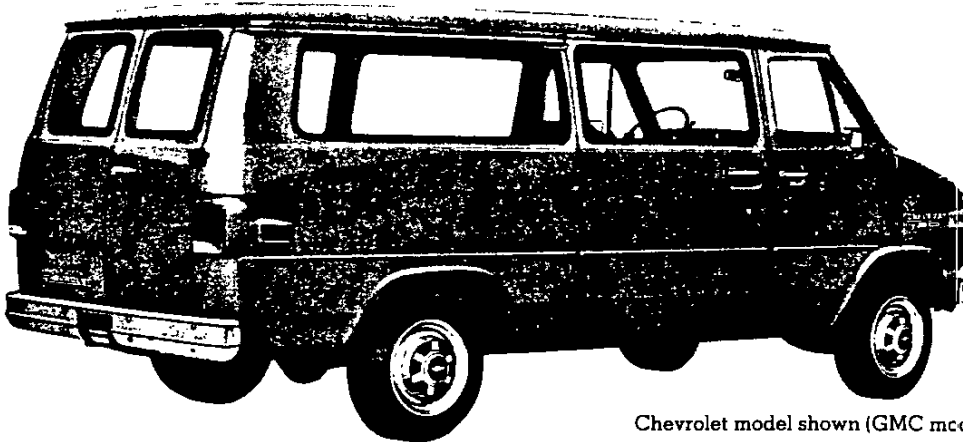

Chevrolet model shown (GMC model available)

6-WINDOW BODY GLASS (RPO A07)

Full body glass consisting of six fixed-glass windows. Option is comprised of LH and RH rear-quarter window glass, LH front-quarter window glass, side cargo door glass, and LH and RH rear cargo door glass. Includes interior non-glare mirror.

FIXED REAR DOOR GLASS (RPO A12)

Consists of RH and LH rear door fixed glass. Includes interior non-glare mirror. Included with 6-Window Body Glass (RPO A07).

SWING-OUT LH SIDE GLASS (RPO A17)

Consists of divided, bright-framed swing-out glass installed on the LH side of the body opposite the side cargo door(s). Individual latches allow independent operation. Requires Swing-Out Side Door Glass (RPO A19).

SWING-OUT SIDE DOOR GLASS (RPO A19)

Swing-out windows for the side cargo door(s) are bright framed. Sliding door unit is divided at the center for individual operation.

SWING-OUT REAR DOOR GLASS (RPO A18)

Consists of LH and RH rear cargo door glass with swing-out hinge and latch. Includes interior non-glare mirror.

CHEVY VAN/VANDURA

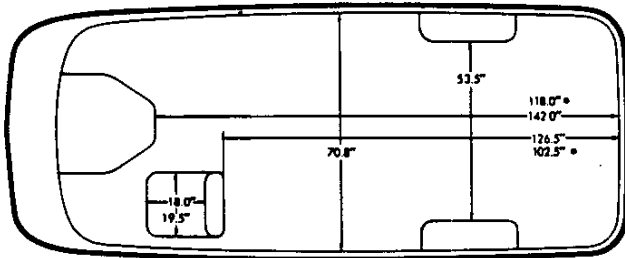

STANDARD DRIVER'S SEAT ONLY

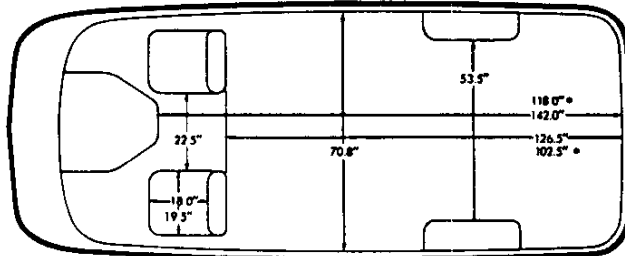

WITH OPTIONAL RH PASSENGER SEAT

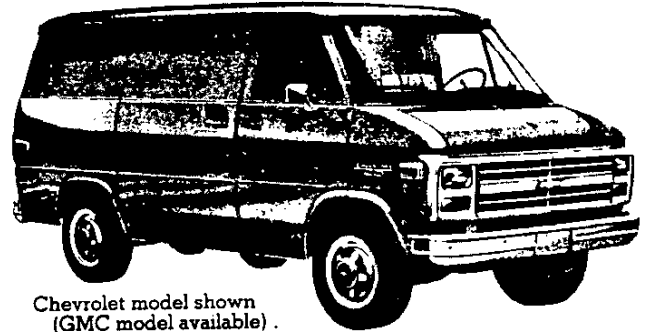

Chevrolet model shown
(GMC model available).

CHEVY VAN/VANDURA SEATING AND LOADSPACE

Seating arrangement for standard and optional front seat.

*110" WB MODELS

INSTRUMENTS

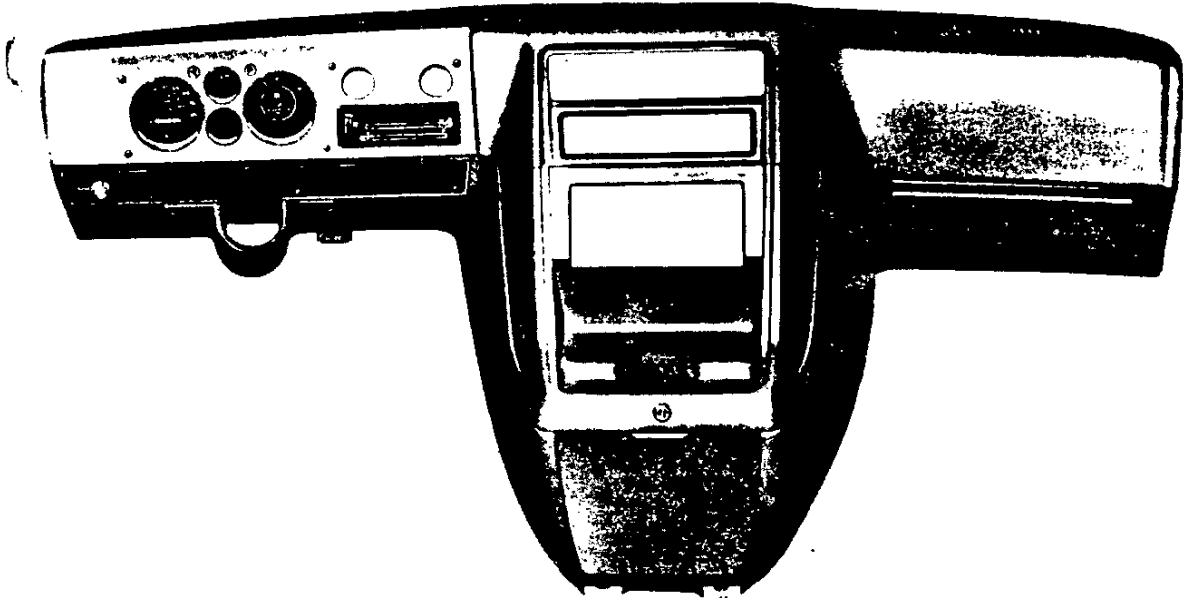

The standard instrument cluster gages and heater controls are set into the molded plastic instrument panel and have bright bezels. The large LH opening contains the speedometer, odometer, high beam indicator, and service-parking brake warning light. Diesel engine models will also have warning lights for low coolant, glow plugs and water-in-fuel.

The large RH opening contains the fuel gage with a graphic symbol. An "Unleaded Fuel Only" notation is carried on the face of the fuel gage for models which require this fuel. The upper small opening between these two large openings houses the warning lights with graphic symbols for temperature, low oil pressure and generator. The lower opening is provided to house the RPO U35 electric clock.

On the upper RH side the two small openings are provided to house the controls for the RPO C36 rear heater (LH) and the RPO C69 rear air conditioner (RH). Below these openings are the heater/defogger and optional front air conditioner controls with graphic symbols for the fan and defogger. A similar instrument cluster with voltmeter, oil pressure gage and engine temperature gage is available as RPO Z53.

The area below the instrument cluster contains, from left to right, the windshield washer/wiper switch, with graphic symbol, main light switch, and ignition switch. This lower area has a black applique with bright trim. At the far left is the provision for the LH front air conditioner air outlet.

CHEVY VAN/VANDURA

BODY CONSTRUCTION FEATURES

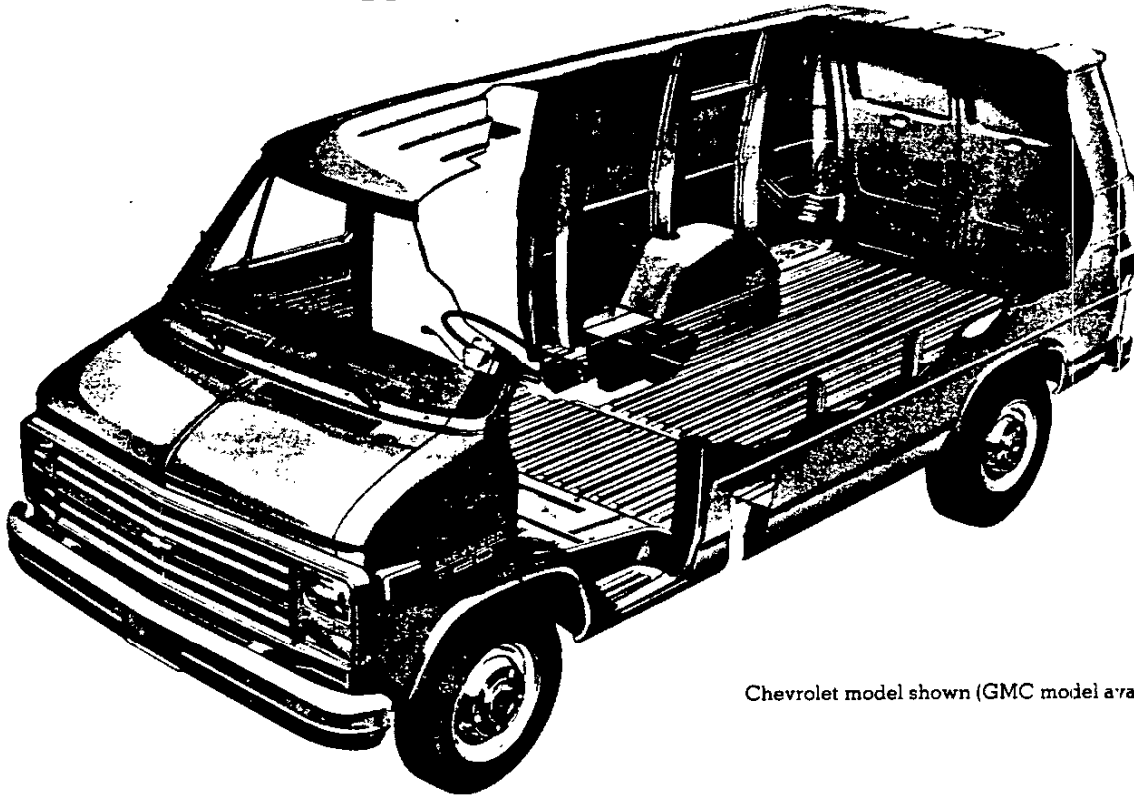

Chevrolet model shown (GMC model available)

The all-steel, Chevy Van/Vandura and Sportvan/Rally bodies feature body-frame integral construction for outstanding structural rigidity and excellent durability. The basic bodies of either the nominal 15 foot (110" WB) or 17 foot (125" WB) models are comprised of an underbody structure, front end structure, left and right hand side panel structures, and a roof panel structure.

Longitudinal side rails, cross sills, and outriggers form the integral frame to which front and rear floor panels are welded, completing the underbody structure. Main structural members are of heavy-gage steel. A step well is incorporated in the underbody in the area adjacent to the front doors and sliding side door to provide convenient entry and exit.

The front end structure incorporates an engine compartment with outside opening hood panel which affords quick and easy access to 27 service points, such as the engine, radiator, battery, brake master cylinder and windshield washer reservoir. The radiator support upper tie bar and baffles are mechanically attached to facilitate engine removal. A plenum chamber with high-level air intake is utilized in the front end structure to assure a plentiful supply of dry, outside air for interior heating and ventilating as well as to add rigidity to the overall body structure. Air outlets to the interior are provided on the left hand and right hand sides by manually controlled doors (RH door omitted with optional air conditioning).

Side panel structures are comprised basically of seamless, one-piece outer panels reinforced with vertical strainers and welded to roof rails at the top and to rocker panels at the bottom. Left hand side panel structures utilize three vertical strainers, with a fourth strainer added for 17-foot bodies. Right hand side panel structures, which are smaller because of the provision for the base side load door, are reinforced with one vertical strainer in 15-foot body applications and two strainers in 17-foot body applications. Two window openings are incorporated in the left hand side panel for all Sportvans/Rally, or for Chevy Vans/Vandura with RPO A07 body glass; one window is incorporated for Chevy Vans/Vandura with RPO A17 body glass. The right hand side panel for Sportvan/Rally models, or Chevy Van/Vandura with RPO A07 or A08 body glass, has one window. Provision is made at the rear of the left hand side panel for incorporation of a door to conceal the fuel tank filler.

Roof panels are of one-piece design and are embossed with six longitudinal stiffening ribs. Four roof bows support the 15-foot body roof panel, while five roof bows are used for the 17-foot body.

Special attention is given to corrosion prevention during the construction and final finishing of the body. The following body design features occur during the construction of the body:

1. Use of special steel (galvanized, zinc iron alloy, zinc coated) for body components especially subject to corrosion.
2. Use of one-piece outer panels to minimize exterior joints where corrosion might occur.
3. Use of heavy-gage steel for main underbody components.
4. Use of weld-through sealers in the assembly process to assure strong welds.

After body construction is completed, additional corrosion preventative steps are taken in the final finishing operation. The following occur:

1. The body, doors and hood are thoroughly cleaned by processing them through a 7-stage zinc phosphate washer.
2. Next, the body, doors and hood are primed by the Elpo electro-coating process which is the deposition of an electrically charged colloidal paint using an electric current. Electro-coating assures uniform application of primer even on surfaces normally inaccessible. In the process, the body, doors and hood are submerged in an emulsion of water and paint; the body, doors and hood and the emulsion are then oppositely charged, causing the paint to adhere to the metal.
3. Sealers are then applied to all critical interior-exterior joints.
4. Undercoating is sprayed on the undersurfaces of the wheel-housings, front door step panels and body rocker panels.
5. The body, doors and hood are painted with enamel.
6. A sealer pad is installed on the top surface of the floor panel at the left hand side, and is bonded to the floor panel as the body bakes in the topcoat oven.
7. The lower inside surfaces of the doors and rocker panels are sprayed with aluminum wax preservative.
8. A protective coating is applied to the front door hinge pins.
9. Finally, an anti-chip coating is added which extends from the rear of the front wheel openings to the rear door openings to prevent stone chipping.

CHEVY VAN/VANDURA

SOLID AND TWO-TONE* EXTERIOR COLOR COMBINATIONS

The application of paint for solid and two-tone exterior color combinations is shown below.



Chevrolet model shown
(GMC model available)

Solid color paint (ZY1) is standard on all models. All painted areas of the body are the same color.

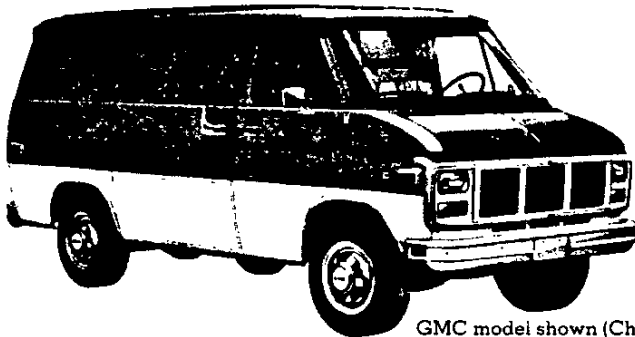

GMC model shown (Chevrolet model available)

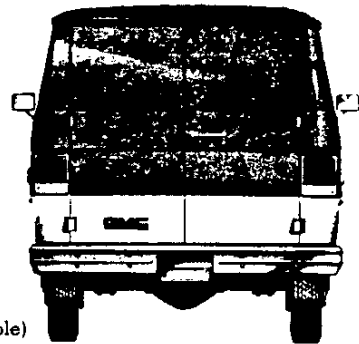

Special two-tone (ZY3) paint colors include black body side and rear moldings. Color code 1 is applied to the areas above the moldings. Color code 2 is applied to the areas below the moldings.

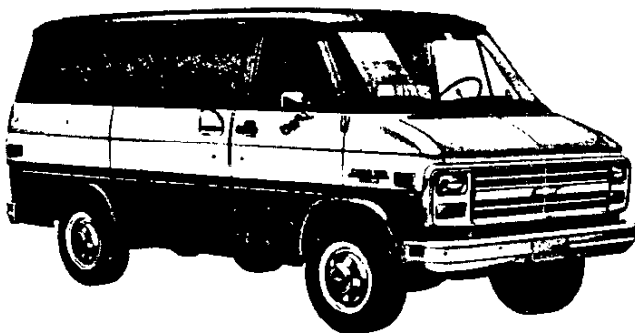

Chevrolet model shown (GMC model available)



Deluxe two-tone (ZY4) paint colors include black body side and rear moldings with bright trim. Color code 1 is applied to the areas above the belt line styling crease line and below the moldings. Color code 2 is applied to the areas between the belt line styling crease line and the moldings.

*Optional at extra cost.

CHEVY VAN/VANDURA

INTERIOR AND EXTERIOR COLOR AVAILABILITY CHART

Please Note: Below are the interior trim color and exterior paint combinations recommended by Chevrolet/GMC. The only available color code 1/color code 2 exterior color combinations are those shown in the chart below, however, any available interior trim color may be ordered with one of these exterior color combinations if the particular combination is desired by the customer.

TRIM LEVEL Seat Type			INTERIOR COLORS				
			Black	Blue	Burgundy	Saddle Tan	Slate Gray
STANDARD MODEL (Two Seats w/A57)							
Vinyl Driver Seat				VDD2		VS S2	
Vinyl High Back Bucket Driver Seat				VDD4		VS S4	
Custom Vinyl High Back Bucket Seat			XBB4	XDD4	XEE4	XSS4	XTT4
EXTERIOR COLORS w/ZY1, ZY3 or ZY4 PAINT		Color Code 1	Color Code 2	RECOMMENDED INTERIOR TRIM COLORS			
BLUE, LIGHT (Metallic)		21	21		X		X
Blue, Galaxy (Metallic)		21	28		X		
White, Frost		21	12		X		
BLUE, GALAXY (Metallic)		28	28		X		X
Blue, Light (Metallic)		28	21		X		X
White, Frost		28	12		X		
BRONZE, INDIAN (Metallic)		66	66				X
Champagne (Metallic)		66	62				X
Copper, Canyon (Metallic)		66	55				X
Tan, Doeskin		66	61				X
White, Frost		66	12				X
BURGUNDY (Metallic)		78	78		X		
Champagne (Metallic)		78	62				X
Gold, Nevada (Metallic)		78	67		X		X
Gray, Steel (Metallic)		78	90		X		
Tan, Doeskin		78	61		X		X
White, Frost		78	12		X		
CHAMPAGNE (Metallic)		62	62				X
Bronze, Indian (Metallic)		62	66				X
Burgundy (Metallic)		62	78		X		
Gold, Nevada (Metallic)		62	67				X
Red, Apple		62	72		X		X
White, Frost		62	12				X
TAN, DOESKIN		61	61				X
Bronze, Indian (Metallic)		61	66				X
Burgundy (Metallic)		61	78		X		
Red, Apple		61	72				X
White, Frost		61	12				X
GOLD, NEVADA (Metallic)		67	67				X
Blue, Galaxy (Metallic)		67	28				X
Bronze, Indian (Metallic)		67	66				X
Burgundy (Metallic)		67	78		X		X
Champagne (Metallic)		67	62				X
Red, Apple		67	72		X		X
Tan, Doeskin		67	61				X
GRAY, STEEL (Metallic)		90	90	X	X	X	X
Blue, Galaxy (Metallic)		90	28		X		
Blue, Light (Metallic)		90	21		X		
Red, Apple		90	72			X	
White, Frost		90	12		X		X
RED, APPLE		72	72			X	X
Champagne (Metallic)		72	62			X	
Burgundy (Metallic)		72	78			X	
Gold, Nevada (Metallic)		72	67			X	X
Tan, Doeskin		72	61				X
White, Frost		72	12			X	
WHITE, FROST		12	12		X	X	X
Blue, Galaxy (Metallic)		12	28		X		X
Blue, Light (Metallic)		12	21		X		
Burgundy (Metallic)		12	78			X	
Champagne (Metallic)		12	62				X
Red, Apple		12	72			X	X

SPORTVAN



SPORTVAN

EXTERIOR

- One new color is available, Champagne Metallic.
- New "Fuel Injection" nameplate is located below the Chevrolet nameplate on the left hand rear door.

BODY

- New base seat trim material. The new color printed vinyl replaces the "basket-weave" vinyl previously used, and is more durable.
- New cargo tie-downs, RPO AP1, are available on G2 & G3 Sportvan models only. The tie-downs are actually the third seat mounting pockets and provide a convenient means of securing cargo behind the second seat or relocating it if desired.

CHASSIS AND POWERTRAIN

- Note: For 1987, all gas engines in these models with GVWRs 10,000 lbs. and under will be certified using the light-duty emissions test procedure. This will require the use of a catalytic converter and unleaded fuel.
- All gas engines in models with GVWRs of 10,000 lbs. and under will have Electronic Fuel Injection (EFI). The advantages are:
 - Improved cold starting
 - Reduced plug fouling
 - Improved fuel economy

- Improved drivability
- Enhanced reliability
- No external adjustments.

THE VORTEC 4.3 LITER V6 ENGINE also features anti-friction roller hydraulic valve lifters for 1987. This new feature helps reduce friction and improve fuel economy.

THE RPO LO3 5.0 LITER (305 CU. IN.) V8 EFI ENGINE is now available nationwide, as well as California. HP and torque are increased by about 6%.

THE 5.7 LITER (350 CU. IN.) V8 EFI ENGINE, RPO LO5, is now available nationwide. Horsepower increases about 18% and torque about 4%.

A single-belt accessory drive, also called serpentine drive, replaces the conventional

multiple V-belts on all engines with EFI. Benefits are:

- Automatic belt tensioning
- Spring-loaded belt tensioner
- 100,000-mile life expectancy.

New Delco Freedom batteries which are lighter in weight and feature a "flat top" design are standard for 1987. They provide higher cold cranking amps for all engines except the 6.2 Liter Diesel. The increases are:

Engine	Cold Cranking Amps	
	1986	1987
4.3 Liter V6	500	525
5.0 & 5.7 Liter V8	405	525
H.D. Battery, RPO UA1	540	630

Delcotron generator capacities have also been increased for all gas engine applications. The base capacity increases from 37 amps to 85 amps. Models equipped with air conditioning have a 100-amp unit.

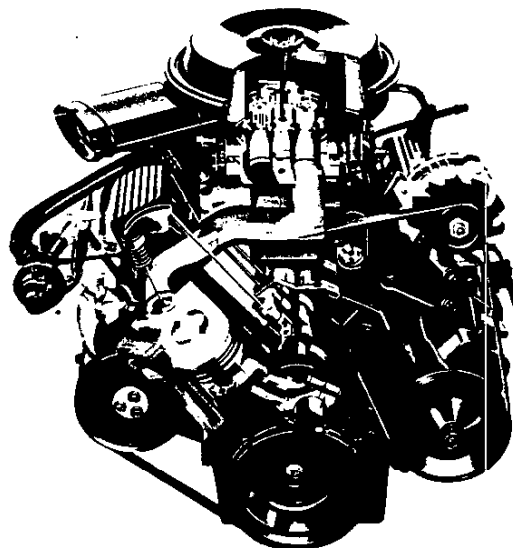

SPORTVAN



OPTIONS

- Stylish Bonaventure Sportvan front end for a fresh look.
- Stylish Beauville Sportvan front-end appearance. Highlights include quad rectangular headlamps and grille with body-color paint-fill treatment.
- Custom Vinyl seat trim fabric.
- Front floor carpeting includes carpet wear pads on the front wheelhousing pickup area for good durability.
- AM/FM stereo radio/stereo cassette with Seek and Scan feature and digital clock.
- Rear speakers included with stereo radios are enclosed in the upper rear pillars on either side of the rear doors. (Note: Speaker grille perforations included on all Bonaventure and Beauville models even without radios.)
- Rear floor mats for Sportvan models.
- Rear compartment combination dome and reading lights, with interrupter switch, allow doors to remain open with dome lamps off.
- All 15" highway-tread, steel-belted radial tires have all-season tread on G10 and G20 models.
- Trailering: When properly equipped, Sportvan can move up to 13,500 lbs. (including Sportvan, passengers, equipment, cargo and trailer).

STANDARD VALUE FEATURES

ALL THIS AT NO EXTRA COST:

- Vortec 4.3 Liter V6 engine with EFI for impressive performance.
- Power steering standard on all models.
- All-season, steel-belted radial ply tires for improved traction, long tread life on G10-20 Series models.
- High-level air intake for heating/ventilation system.
- Convenient storage space under both front standard bucket seats.
- Inside hood release for greater security.
- Windshield washers with nozzles attached to wiper arms for more effective cleaning.
- Instrument panel extension has ashtray, handy storage bin and parcel tray.
- Large fuse block for easier servicing.
- Large glass area for good visibility.
- Driver seat mounted on extended track for more leg room.
- Choice of swing-out or sliding side cargo doors provides buyers with great flexibility.
- Semi-metallic front and nonmetallic rear brake linings on most models.
- Height-sensing rear brake proportioning valve for better braking balance when loaded and unloaded on G30 models with 8,600 GVWR or over.
- Concealed front and side door steps for easy access to cargo or seating area.



- Choice of sliding side door or 60/40 swing-out doors at no extra cost.
- Wide rear door opening, a full 54.4 inches. Opens a full 180° for easy dock loading.
- Fully independent coil-spring front suspension helps minimize road shock and smooth the ride.
- Bonded hem flanges on doors eliminate spot weld marks.
- Unitized body construction.
- Anti-chip coating along the lower body and protective coating over front door hinge pins.
- Sealers help keep moisture from critical joints in wheel-housings, rocker panels and front door. Step panels are sprayed with underbody protective coating.
- Cab and entire underbody are ELPO primed through immersion in an electrically charged primer paint. A positive and negative electrical charge draws paint into hard-to-reach cracks and crevices for corrosion protection.
- Aluminized exhaust system for added life.

IMPROVED ANTI-CORROSION PROTECTION:

- Special steels used for selected components to help fight corrosion. Includes two-sided galvanized steel inner and outer hood panels, LH and RH body side door outer panels, sliding side door outer panel, sliding side door upper outer track and cover.

SEATING ARRANGEMENTS



Standard 5-Passenger Seating (125" WB)

Optional 8-Passenger Seating (125" WB)

Optional 12-Passenger Seating (G30 only)

CARGO CAPACITY WITH AVAILABLE SEATING

	G10 110" WB	G10 125" WB	G20 125" WB	G30 125" WB	G30 w/C6P 125" WB
2-Passenger Seating With Standard Rear Seat Removed					
2 High-Back Bucket Seats	STD	STD	STD	STD	STD
Capacity Behind Seats (cu. ft.)	214	260	260	260	260
5-Passenger Seating					
2 High-Back Bucket Seats	STD	STD	STD	STD	STD
1st 3-Passenger Rear Seat	STD	STD	STD	STD	STD
Capacity Behind Seats (cu. ft.)	139	186	186	186	186
8-Passenger Seating					
2 High-Back Bucket Seats	-	-	STD	STD	STD
1st 3-Passenger Rear Seat	-	-	STD	STD	STD
2nd 3-Passenger Rear Seat	-	-	AQ3	AQ3	AQ3
Capacity Behind Seats (cu. ft.)	-	-	118	118	118
12-Passenger Seating					
2 High-Back Bucket Seats	-	-	-	STD	STD
1st 3-Passenger Rear Seat	-	-	-	STD	STD
2nd 3-Passenger Rear Seat and 4-Passenger Rear Seat	-	-	-	AQ4	AQ4
Capacity Behind Seats (cu. ft.)	-	-	-	49	49
Cargo Length at Floor (Back of seat to rear door)	102.5"	126.5"	126.5"	126.5"	126.5"
Distance between wheelhousings	53.5"	53.5"	53.5"	53.5"	53.5"

Also available is a Travel Bed Seating Package (RPO B6S)

ENGINE VALUE FEATURES

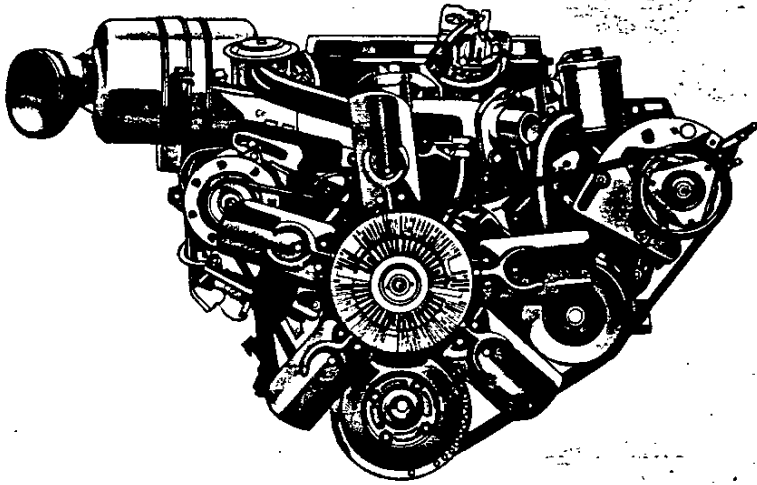

The Vortec 4.3 Liter V6 gas engine is a naturally aspirated 90° V6 with 4-cycle design. Advantages of this engine include:

- Electronic Fuel Injection
- Improved mixing of fuel and air as a result of the swirl-port induction system.
- More complete fuel burning due to the centralized spark plug combustion chamber.
- Volumetric efficiency is the major result of the higher 9.3 to 1 compression ratio. The high-compression ratio is coupled with the Electronic Spark Control (ESC), which controls spark knock.

In addition to the above, the 4.3 Liter V6 basic features are:

- Copper core spark plugs help prevent plug fouling.
- Single-point air injection.
- Even firing results in smooth operation and allows a low idle speed.
- Stone-ground, microfinished crankshaft.
- Tubular stainless steel exhaust manifolds.
- Low-tension oil rings for reduced friction.
- Rocker arm covers fit into a recess in the cylinder heads for better sealing.

V8 POWER AVAILABLE.

For extra power, Chevrolet offers a choice of rugged V8s: The 5.0 Liter (305 Cu. In.) with Electronic Spark Control and a 5.7 Liter (350 Cu. In.) that's standard on heavy-duty G30 Chevy Vans.

V8 EFI ENGINES. The 5.0 Liter engine, RPO L03, and the 5.7 Liter engine, RPO L05, are now available with Electronic Fuel Injection for improved performance and drivability.

6.2 LITER (379 CU. IN.) L.D. for G20 Series and H.D. for G30 Series. (Not available in California.) Proven design. Provides impressive torque with diesel efficiency.

CHASSIS VALUE FEATURES

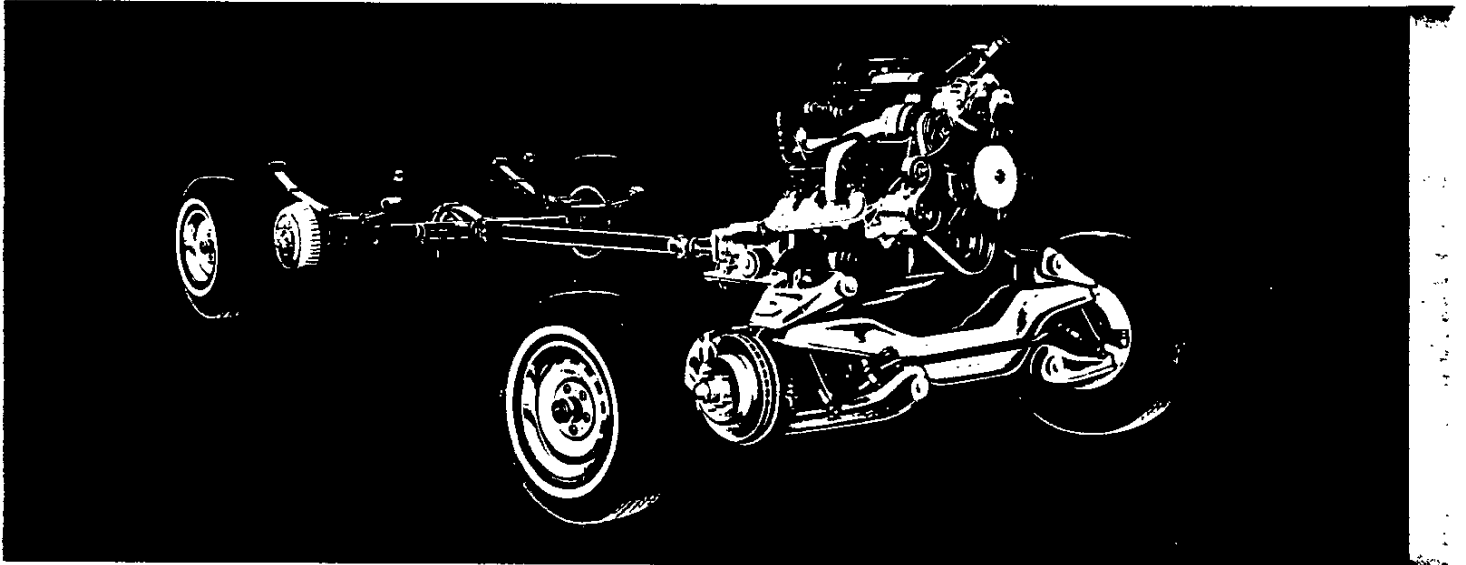

ALUMINIZED EXHAUST SYSTEM

- Coated inside and out for extended life.
- Special hangers allow for heat expansion.

TRANSMISSIONS

- Floor-mounted, fully synchronized, 3-speed manual transmissions standard in G10 Sportvan, G20 gasoline engine Sportvan.
- 4-speed, synchronized manual transmissions with overdrive standard in G20 Sportvans with diesel engines.
- 3-speed automatic transmissions standard in G30/C6P Sportvans.

FRONT SUSPENSION

- Chevy's rugged girder beam independent front suspension puts a husky coil spring at each wheel along with tough suspension members, for a smooth, quiet ride.

REAR AXLES

- 5,700-lb.-capacity Salisbury semi-floating design for G30 models features a 9½" ring gear.
- Locking rear differential, RPO G80, available on all models.
- Two-stage multileaf rear springs automatically adjust to the load.

COUNTER-ANGLED REAR SHOCKS

- Designed to help reduce wheel hop.

BRAKES

Front disc brakes and finned-drum rear brakes are incorporated into complete braking systems, which are computer matched to each model. Audible wear sensors warn of need to replace front brake pads. Semi-metallic front brake linings on G10 and G20, as well as nonasbestos rear linings on most vehicles. G30 Sportvans with 8,600 GVWR have height-sensing rear brake proportioning valve for better braking balance under loaded and unloaded conditions.

WIDE-STANCE CHASSIS DESIGN

- Contributes to good stability.

BONAVENTURE/BEAUVILLE TRIM OPTIONS



Beauville trim

The Bonaventure has two front high-back bucket seats and rear bench seat in Custom Vinyl. Choose from four colors: Blue, Burgundy, Saddle Tan and Slate Gray. In addition to the Custom Vinyl, the top-of-the-line Beauville adds Custom Cloth high-back or reclining bucket seats to the list of available Sportvan seat trims.

Armrests are included on each side of each reclining seat. Cloth seat trim colors: Blue, Burgundy, Mahogany, Saddle Tan and Slate Gray. See pages F and G for complete details on other trim features of the Bonaventure and Beauville options.

SPORTVAN/RALLY

SPORTVAN/RALLY MODEL SELECTOR

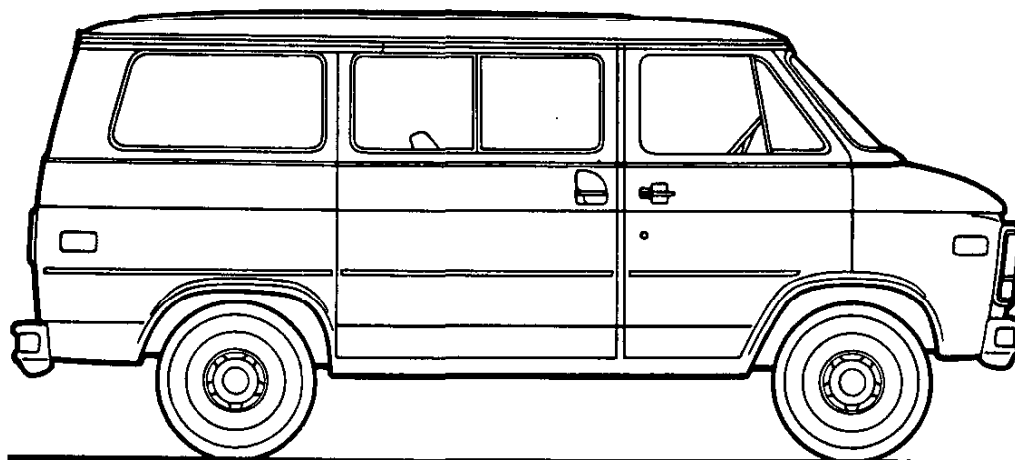

SERIES	MODEL NUMBER		BODY ORDERING CODE		
	110" WB	125" WB	SPORTVAN/ RALLY	*BONAVENTURE/ RALLY CUSTOM	*BEAUVILLE/ RALLY STX
GASOLINE MODELS					
♦G10/1500	G11006	G11306	ZW9	ZM2	E94
G20/2500	—	G21306	ZW9	ZM2	E94
•G30/3500	—	G31306	ZW9	ZM2	E94
G30/3500/C6P	—	G31306	ZW9/C6P	ZM2/C6P	E94/C6P
DIESEL MODELS					
♦G20/2500	—	G21306	ZW9/B3J	ZM2/B3J	E94/B3J
G30/3500/C6P	—	G31306	ZW9/C6P/B3J	ZM2/C6P/B3J	E94/C6P/B3J

*125" WB models only.

♦ Not available for registration in the State of California.

•Model G31306 without C6P has RPO AQ4—Two Additional Rear Seats—included as standard equipment to provide 12-passenger seating.

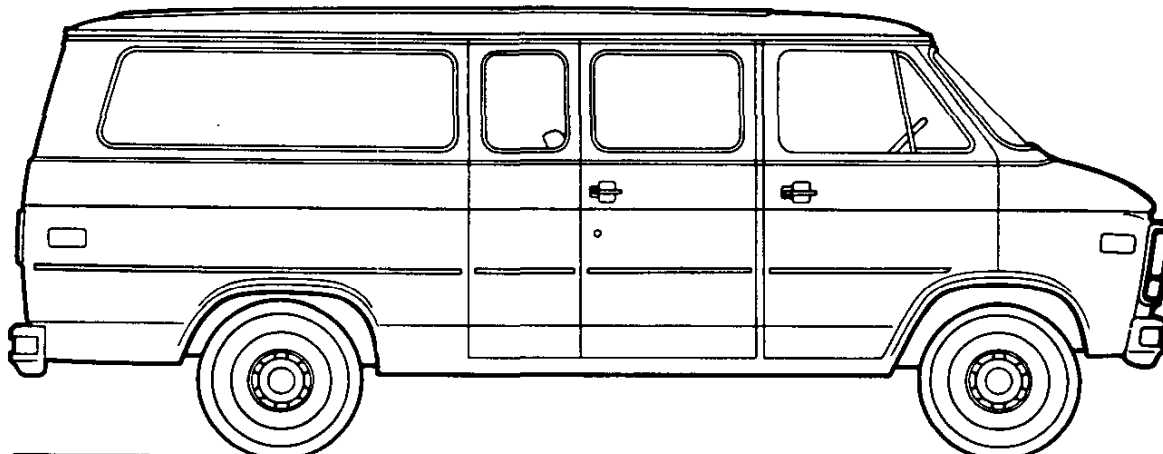

GASOLINE

SPORTVAN/RALLY
STANDARD SPECIFICATIONS

(See Gray Tab Section for Specification Details)

Series	G10/1500■	G20/2500
Engine	4.3 Liter, 262 EFI V6	
Base Equip.	11"; 124 sq. in.	
Clutch	Oiled-paper Element	
Air Filter	Throwaway Type	
Oil Filter	Single; Aluminized	
Exhaust System	See Engine & Cooling section for specific model applications	
Emission Control Systems		
Suspension, Front	Independent; Coil Springs	
Capacity	3400 lb.	
Springs @ Ground	1700 lb. ea.	
Shock Absorbers	25mm dia.	
Stabilizer Bar	-	
Suspension, Rear	Salisbury Axle; Hypoid Drive; Two-stage Multi-leaf Springs	
Axle Capacity	3500 lb.	
Axle Ratio	3.42	
Springs @ Ground	1700 lb. ea.	
Shock Absorbers	25mm dia.	
Brakes	Hydraulic; Self-adjusting	
Front	Disc; 11.86" Rotor	Disc; 11.86" Rotor
Rear	Drum; 11" x 2"	Drum; 11.15" x 2.75"
Booster	Single Diaphragm	Dual Diaphragm
Parking	Cable to Rear Wheels	
Electrical	12 Volt; Negative Ground	
Battery - Freedom Type	525 CCA♦ @ 0°F.	
- Reserve Capacity	90 min. @ 80°F.	
Delcotron Generator	85 amp.	
Frame	Integral Body-frame	
Fuel Tank (nominal capacity)	22 gal.	
Steering Gear Type	Integral Power	
Transmission	Fully Synchronized 3-Speed Manual	
Shift Location	Floor	
Tires	(5) P205/75R15 All Seasons Steel Belted Radial	(4) P225/75R15 All Seasons Steel Belted Radial
Wheels	(5) Disc 15" x 6.0"	

■ Not available for registration in the State of California

♦ CCA-Cold Cranking Amps

SPORTVAN/RALLY

STANDARD SPECIFICATIONS



(See Gray Tab Section for Specification Details)

Series▲	★G20/2500
Engine Base Equip. Clutch Air Filter Oil Filter Oil Cooler Exhaust System Emission Control Systems	6.2 Liter, 379 Cu. In. V8 Diesel 12"; 150 sq. in. Poly-wrapped, Oiled-paper Element Throwaway Type Standard Dual; Aluminized See Engine & Cooling section for specific model applications
Suspension, Front Capacity Springs @ Ground Shock Absorbers	Independent; Coil Springs 3675 lb. 1835 lb. ea. 25mm dia.
Suspension, Rear Axle Capacity Axle Ratio Springs @ Ground Shock Absorbers	Salisbury Axle; Hypoid Drive; Two-stage Multi-leaf Springs 3500 lb. 3.42 1700 lb. ea. 25mm dia.
Brakes Front Rear Booster Parking	Hydraulic; Self-adjusting Disc; 11.86" Rotor Drum; 11.15" x 2.75" Hydraulic Power Cable to Rear Wheels
Electrical Battery - Freedom Type - Reserve Capacity Delcotron Generator Engine Block Heater	12 Volt; Negative Ground Two; 540 CCA♦ ea. @ 0°F. 115 min. ea. @ 80°F. 66 amp. 600 watts, 120 volts
Frame	Integral Body-frame
Fuel Tank (nominal capacity)	22 gal.
Steering Gear Type	Integral Power
Transmission Shift Location	4-Speed Automatic w/Overdrive Steering Column
Tires	(4) P235/75R15 All Seasons Steel Belted Radial
Wheels	(5) Disc 15" x 6.0"

▲ Note: G10/1500 models not available with diesel engine

★ Not available for registration in State of California

♦ CCA-Cold Cranking Amps

GASOLINE**SPORTVAN/RALLY****STANDARD SPECIFICATIONS**

(See Gray Tab Section for Specification Details)

Series	G30/3500•	G30/3500/C6P
Engine	5.7 Liter, 350 EFI V8	
Base Equip.	Oiled-paper Element	
Air Filter	Throwaway Type	
Oil Filter	Single; Aluminized	*Dual; Stainless Steel
Exhaust System	See Engine & Cooling section for specific model applications	
Emission Control Systems		
Suspension, Front	Independent; Coil Springs	
Capacity	3900 lb.	3900 lb.
Springs @ Ground	1700 lb. ea.	1950 lb. ea.
Shock Absorbers	25mm dia.	25mm dia.
Stabilizer Bar	1.06" dia.	1.06" dia.
Suspension, Rear	Salisbury Axle; Hypoid Drive; Two-stage Multi-leaf Springs	
Axle Capacity	5700 lb.	5700 lb.
Axle Ratio	3.23	3.73
Springs @ Ground	2100 lb. ea.	2700 lb. ea.
Shock Absorbers	25mm dia.	25mm dia.
Brakes	Hydraulic; Self-adjusting	
Front	Disc; 12.5" Rotor	
Rear	Drum; 13" x 2.5"	
Booster	Dual Diaphragm	
Parking	Cable to Rear Wheels	
Electrical	12 Volt; Negative Ground	
Battery - Freedom Type	525 CCA♦ @ 0°F.	
- Reserve Capacity	90 min. @ 80°F.	
Delcotron Generator	85 amp.	
Frame	Integral Body-frame	
Fuel Tank (nominal capacity)	22 gal.	
Steering Gear Type	Integral Power	
Transmission	4-Speed Automatic w/Overdrive	3-Speed Automatic
Shift Location	Steering Column	Steering Column
Tires	(4) 8.75R-16.5D(8PR)	(4) 8.75-16.5E(10PR)
Wheels	(5) Disc 16.5" x 6.75"	

•Model G31306 without C6P has RPO AQ4—Two Additional Rear Seats—included as standard equipment to provide 12-passenger seating.

♦CCA-Cold Cranking Amps

*Single; Aluminized for California

SPORTVAN/RALLY

DIESEL

STANDARD SPECIFICATIONS

(See Gray-Tab Section for Specification Details)

SeriesA	G30/3500/C6P
Engine	
Base Equip.	6.2 Liter, 379 Cu. In. V8 Diesel
Air Filter	Poly-wrapped, Oiled-paper Element
Oil Filter	Throwaway Type
Oil Cooler	Standard
Exhaust System	Dual; Aluminized
Emission Control Systems	See Engine & Cooling section for specific model applications
Suspension, Front	Independent; Coil Springs
Capacity	3900 lb.
Springs @ Ground	1950 lb. ea.
Shock Absorbers	25mm dia.
Stabilizer Bar	1.06" dia.
Suspension, Rear	Salisbury Axle; Hypoid Drive; Two-stage Multi-leaf Springs
Axle Capacity	5700 lb.
Axle Ratio	3.73
Springs @ Ground	2700 lb. ea.
Shock Absorbers	25mm dia.
Brakes	Hydraulic; Self-adjusting
Front	Disc; 12.5" Rotor
Rear	Drum; 13" x 2.5"
Booster	Hydraulic Power
Parking	Cable to Rear Wheels
Electrical	12 Volt; Negative Ground
Battery - Freedom Type	Two; 540 CCA♦ ea. @ 0°F.
- Reserve Capacity	115 min. ea. @ 80°F.
Delcotron Generator	66 amp.
Engine Block Heater	600 watts, 120 volts
Frame	Integral Body-frame
Fuel Tank (nominal capacity)	22 gal.
Steering Gear Type	Integral Power
Transmission	3-Speed Automatic
Shift Location	Steering Column
Tires	(4) 8.75-16.5E(10PR)
Wheels	(5) Disc 16.5" x 6.75"

▲Note: G30/3500 models without C6P not available with diesel engine.

♦CCA-Cold Cranking Amps

GASOLINE

SPORTVAN/RALLY

Body Ordering Codes:
 Sportvan/Rally—ZW9
 Bonaventure Sportvan/Rally Custom—ZM2‡
 Beauville Sportvan/Rally STX—E94‡

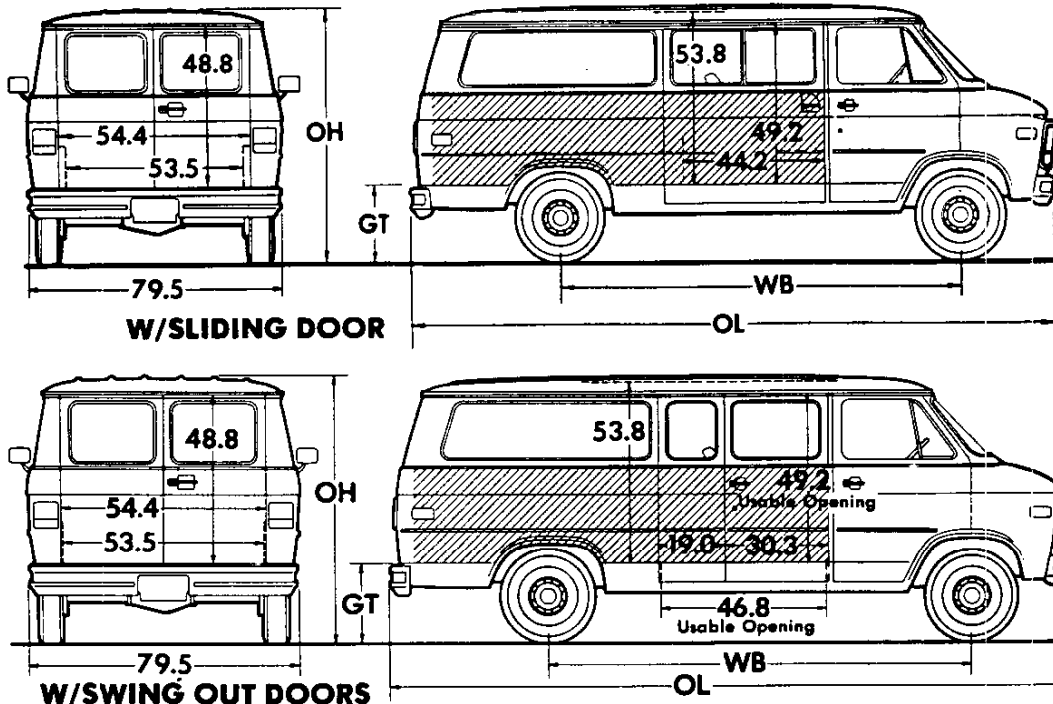

Side slide-in opening clearance 44.2" with sliding door; 46.8" with swing out doors; max. box cargo height 49.2" with standard front passenger seat.

Rear slide-in opening clearance 52" with spare tire in position or 53.5" with spare tire removed; height 48.8".

Sign Panel Area (side)

110" WB—29" x 97"
 125" WB—29" x 121½"

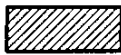

Series	Ground Clearance (in)†	
	Front	Rear
G1	6.3	6.7
G2	7.3	7.3
G3	9.0	7.0

Model	Engine No. Cyl.	Dimensions (in)†				‡Curb Weight (lb)			‡Model Weight (lb)*		
		WB	OL	OH	GT	Front	Rear	Total	Front	Rear	Total

G10/1500 SERIES

G11006	6	110	178.2	79.4	25.0	2236	1770	4006	2631	2125	4756
G11306	6	125	202.2	79.2	24.6	2315	1871	4186	2750	2186	4936

G20/2500 SERIES

* G21306	6	125	202.2	79.5	25.1	2380	1836	4216	2815	2151	4966
-----------------	---	-----	-------	------	------	------	------	------	------	------	------

G30/3500 SERIES

G31306■	8	125	202.2	81.9	28.0	2644	2387	5031	3135	3696	6831
G31306 (w/C6P)	8	125	202.2	81.9	28.0	2626	2151	4777	3061	2466	5527

†Dimensions with standard equipment, unloaded.

*Model Weight includes Curb Weight plus occupants (standard seating capacity x 150 lb). Total Model Weight may vary as much as ±50 lbs. to allow for production build variation.

‡Curb Weights and Model Weights shown are for models with ZW9 Sportvan/Rally body. For models with E94 Beauville Sportvan/Rally STX body add: for Front 47 lb.; Rear 98 lb.; Total 145 lb. For models with ZM2 Bonaventure/Rally Custom body add: Front 25 lb.; Rear 74 lb.; Total 99 lb.

■Model G31306 without C6P has RPO AQ4—Two Additional Rear Seats—included as standard equipment to provide 12-passenger seating.

SPORTVAN/RALLY

Body Ordering Codes:
 Sportvan/Rally—ZW9/B3J
 Bonaventure Sportvan/Rally Custom—ZM2/B3J‡
 Beauville Sportvan/Rally STX—E94/B3J‡

DIESEL

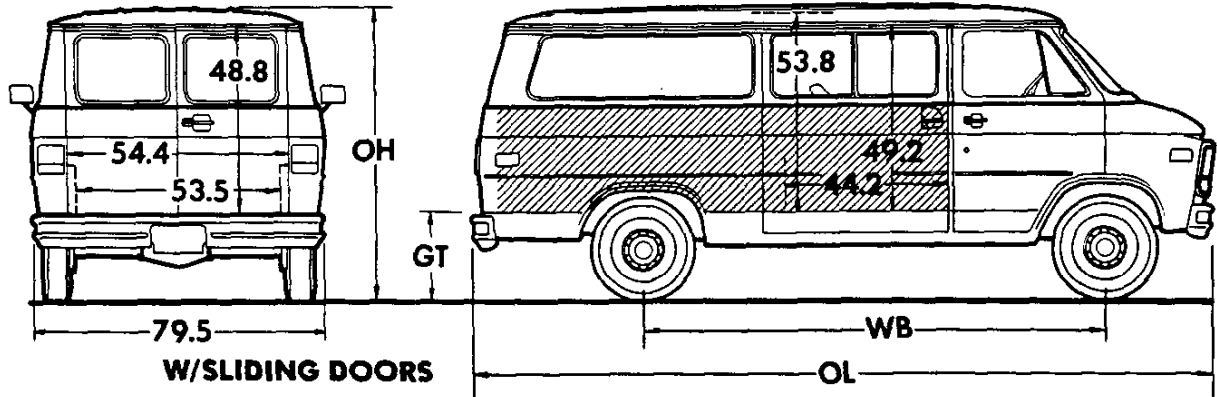

W/SLIDING DOORS

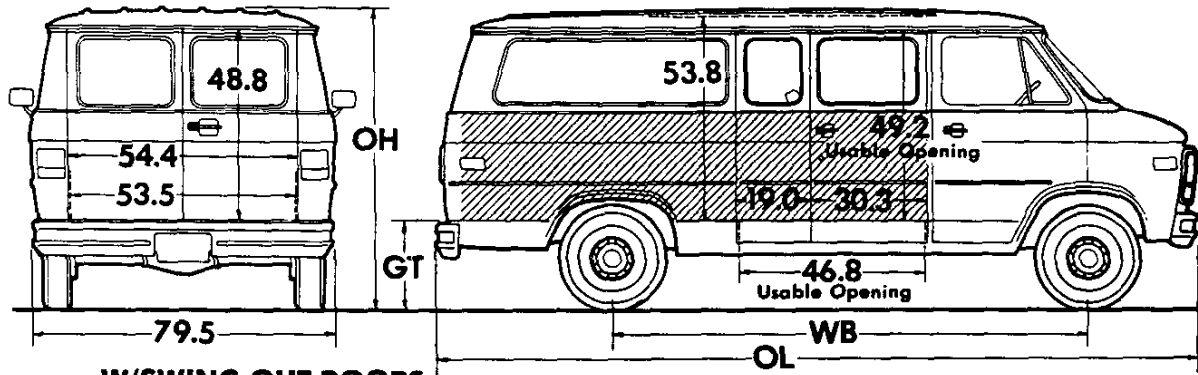

W/SWING OUT DOORS

Side slide-in opening clearance 44.2" with sliding door; 46.8" with swing out doors; max. box cargo height 49.2" with standard front passenger seat.

Rear slide-in opening clearance 52" with spare tire in position or 53.5" with spare tire removed; height 48.8"

Sign Panel Area (side)

110" WB—29" x 97"
 125" WB—29" x 121½"



Series	Ground Clearance (in)†	
	Front	Rear
G2	7.3	7.3
G3	9.0	7.0

Model	Engine No. Cyl.	Dimensions (in)†				‡Curb Weight (lb)			‡Model Weight (lb)*		
		WB	OL	OH	GT	Front	Rear	Total	Front	Rear	Total

G20/2500 SERIES

G21306	8	125	202.2	79.5	25.1	2778	1888	4666	3213	2203	5416
---------------	---	-----	-------	------	------	------	------	------	------	------	------

G30/3500 SERIES

G31306 (w/C6P)	8	125	202.2	81.9	28.0	2866	2135	5001	3301	2450	5751
-----------------------	---	-----	-------	------	------	------	------	------	------	------	------

†Dimensions with standard equipment, unloaded.

*Model Weight includes Curb Weight plus occupants (standard seating capacity x 150 lb). Total Model Weight may vary as much as ±50 lbs. to allow for production build variation.

‡Curb Weights and Model Weights shown are for models with ZW9 Sportvan/Rally body. For models with E94 Beauville Sportvan/Rally STX body add: G21306—Front 101 lb.; Rear 157 lb.; Total 258 lb. G21306/C6P—Front 35 lb.; Rear 90 lb.; Total 125 lb. For models with ZM2 Bonaventure/Rally Custom body add: G21306—Front 26 lb.; Rear 100 lb.; Total 126 lb. G21306/C6P—Front 25 lb.; Rear 74 lb.; Total 99 lb.

SPORTVAN/RALLY

POWER TEAMS

ALL STATES EXCEPT CALIFORNIA*

G10/1500 SERIES

POWER TEAMS (MUST ORDER ENGINE, TRANSMISSION AND REAR AXLE)
 (Consult GVWR Selector and Tire Chart to insure tire capacity and availability)

ENGINE	TRANSMISSION		AXLES				GVWR
	3-SP	AUTO	2.73	3.08	3.42	3.73	
W/NA5 STANDARD EMISSION EQUIPMENT							
LB4 V6 4.3 Liter EFI	MM3		—	—	GQ1	—	56/6000
		MX0	—	—	*GQ1	*GT4	56/6000
#L03 V8 5.0 Liter EFI		MX0	—	GQ1	GU6	—	56/6000
#L05 V8 5.7 Liter EFI		MX0	GQ1	GU4	—	—	56/6000
W/NA6 HIGH ALTITUDE EMISSION EQUIPMENT							
LB4 V6 4.3 Liter EFI	MM3		—	—	GQ1	—	56/6000
		MX0	—	—	*GQ1	*GT4	56/6000
#L03 V8 5.0 Liter EFI		MX0	—	GQ1	GU6	—	56/6000
#L05 V8 5.7 Liter EFI		MX0	GQ1	GU4	—	—	56/6000

*Reqs KC4 Cooling

#Reqs P215/75 R15 Tires on CG11306 only.

#Available on G11306 Only

◆ G10/1500 Sportvan/Rally not available for registration in the state of California.

GVWR SELECTOR—ALL STATES EXCEPT CALIFORNIA*

G10/1500 SERIES

GVW Rating (lbs)	†GAWR (lbs)		Minimum Equipment Required for GVW Rating		
	Front	Rear	Tire Capacity (lbs ea)		Chassis Equipment
			Front	Rear	
5600	2906	2906	1453	1453	Standard
6000	3166	3166	1583	1583	HD Power Brakes (J55)

†GAWR's shown are the maximum for each axle with equipment listed. Other GAWR's are available, and they are determined as the minimum capacity of either axle, springs or tires.

FRONT AND REAR TIRE AVAILABILITY CHART—ALL STATES EXCEPT CALIFORNIA*

G10/1500 SERIES

Spare tire to match either front or rear tires must be ordered.

Description	Capacity (lbs ea)	Highway		On-Off Road	Spare
		Front	Rear	Rear	
TUBELESS					
P205/75R15 Steel Belted Radial	1453	XCE	YCE	— YJT	ZCE ZJT
P205/75R15 Whitewall Steel Belted Radial	1453	XCG	YCG	—	ZCG
P205/75R15 White Letter Steel Belted Radial	1453	XCF	YCF	—	ZCF
P215/75R15 Steel Belted Radial	1583	XCU	YCU	—	ZCU
P215-75R15 Whitewall Steel Belted Radial	1583	XCV	YCV	—	ZCV
P215/75R15 White Letter Steel Belted Radial	1583	XCW	YCW	—	ZCW

◆ G10/1500 Sportvan/Rally not available for registration in the state of California.

SPORTVAN/RALLY POWER TEAMS

ALL STATES EXCEPT CALIFORNIA

G20/2500 SERIES

POWER TEAMS (MUST ORDER ENGINE, TRANSMISSION AND REAR AXLE)

(Consult GVWR Selector and Tire Chart to insure tire capacity and availability)

ENGINE	TRANSMISSION			AXLES				GVWR
	3-SP	4-SP	AUTO	2.73	3.08	3.42	3.73	
W/NA5 STANDARD EMISSION EQUIPMENT								
LB4 V6 4.3 Liter EFI	MM3			—	—	GQ1	—	6600
L03 V8 5.0 Liter EFI			MX0	—	—	#GQ1	%GT4	6600
L05 V8 5.7 Liter EFI			MX0	—	—	GU6	*GT4	6600
L05 V8 5.7 Liter EFI			MX0	GQ1	GU4	—	*GT4	6600
LH6 Diesel 6.2 Liter V8 (379 Cu In) (Reqs B3J)		MM7	MX0	—	—	GQ1	*GT4	6850
				—	—	GQ1	—	6850
W/NA6 HIGH ALTITUDE EMISSION EQUIPMENT								
LB4 V6 4.3 Liter EFI	MM3			—	—	GQ1	—	6600
L03 V8 5.0 Liter EFI			MX0	—	—	#GQ1	%GT4	6600
L05 V8 5.7 Liter EFI			MX0	—	—	GQ1	*GT4	6600
L05 V8 5.7 Liter EFI			MX0	GQ1	GU4	—	*GT4	6600
LH6 Diesel 6.2 Liter V8 (379 Cu In)(Reqs B3J)		MM7	MX0	—	—	GQ1	*GT4	6850
				—	—	GQ1	—	6850

*Reqs Z82 Trailing Special; N/A G80 Locking Differential #Reqs KC4 Cooling
%N/A G80 Locking Differential; Reqs KC4 Cooling

G30/3500 SERIES

ENGINE	TRANSMISSION		AXLES			GVWR
	AUTO		3.23	3.73	4.10	
W/NA5 STANDARD, NA6 HIGH ALTITUDE EMISSION EQUIPMENT						
# L05 V8 5.7 Liter EFI	MX0		GQ1	—	—	7400
	MX1		—	GQ1	GT5	8600
LL4 Diesel 6.2 Liter V8 (379 Cu In) (Reqs C6P and B3J)	MX1		—	GQ1	GT5	8600

*N/A NA6 High Altitude Emission. With NA5 Standard Emission Satisfies High Altitude Emission Requirements #W/8600 GVWR Reqs C6P
■ High Altitude Emission Equipment (FOR EXHAUST SMOKE REDUCTION PURPOSES AT HIGH ALTITUDE; NOT REQUIRED TO SATISFY HIGH ALTITUDE EMISSION REGULATIONS). (REQS. LL4 ENG)

CALIFORNIA ONLY

G20/2500 SERIES

ENGINE	TRANSMISSION			AXLES				GVWR
	3-SP	4-SP	AUTO	2.73	3.08	3.42	#3.73	
W/YF5 CALIFORNIA EMISSION REQUIREMENTS								
LB4 V6 4.3 Liter EFI	MM3			—	—	GQ1	—	6600
L05 V8 5.7 Liter EFI			MX0	—	—	#GQ1	%GT4	6600
L05 V8 5.7 Liter EFI			MX0	GQ1	GU4	—	*GT4	6600

*Reqs Z82 Trailing Special; N/A G80 Locking Differential
%N/A G80 Locking Differential; Reqs KC4 Cooling
#Reqs KC4 Cooling

G30/3500 SERIES

ENGINE	TRANSMISSION		AXLES			GVWR
	AUTO		3.23	3.73	4.10	
W/YF5 CALIFORNIA EMISSION EQUIPMENT						
# L05 V8 5.7 Liter EFI	MX0		GQ1	—	—	7400
	MX1		—	GQ1	GT5	8600
LL4 Diesel 6.2 Liter V8 (379 Cu In) (Reqs C6P and B3J)	MX1		—	GQ1	GT5	8600

*N/A NA6 High Altitude Emission. With NA5 Standard Emission Satisfies High Altitude Emission Requirements
#W/8600 GVWR Reqs C6P

SPORTVAN/RALLY

GVWR SELECTOR—ALL STATES EXCEPT CALIFORNIA*

G10/1500 SERIES

GVW Rating (lbs)	†GAWR (lbs)		Minimum Equipment Required for GVW Rating		
			Tire Capacity (lbs ea)		Chassis Equipment
	Front	Rear	Front	Rear	
5600	2906	2906	1453	1453	Standard
6000	3166	3166	1583	1583	HD Power Brakes (J55)

†GAWR's shown are the maximum for each axle with equipment listed. Other GAWR's are available, and they are determined as the minimum capacity of either axle, springs or tires.

FRONT AND REAR TIRE AVAILABILITY CHART—ALL STATES EXCEPT CALIFORNIA*

G10/1500 SERIES

Spare tire to match either front or rear tires must be ordered.

Description	Capacity (lbs ea)	Highway		On-Off Road	Spare
		Front	Rear	Rear	
TUBELESS					
P205/75R15 Steel Belted Radial	1453	XCE —	YCE —	— YJT	ZCE ZJT
P205/75R15 Whitewall Steel Belted Radial	1453	XCG	YCG	—	ZCG
P205/75R15 White Letter Steel Belted Radial	1453	XCF	YCF	—	ZCF
P215/75R15 Steel Belted Radial	1583	XCU	YCU	—	ZCU
P215-75R15 Whitewall Steel Belted Radial	1583	XCV	YCV	—	ZCV
P215/75R15 White Letter Steel Belted Radial	1583	XCW	YCW	—	ZCW

♦ G10/1500 Sportvan/Rally not available for registration in the state of California.

ENGINE RATINGS

ALL STATES

SAE Net Ratings	*4.3 Liter 262 EFI V6	*5.0 Liter 305 EFI V8	*5.7 Liter 350 EFI V8
Net Horsepower	150 @ 4000 rpm	170 @ 4000 rpm	195 @ 4000 rpm
Net Torque, lb-ft	230 @ 2400 rpm	255 @ 2400 rpm	290 @ 2800 rpm
SAE Net Ratings	**5.7 Liter 350 EFI V8	*6.2 Liter 379 V8 Diesel	**6.2 Liter 379 V8 Diesel
Net Horsepower	185 @ 4000	130 @ 3600 rpm	145 @ 3600 rpm
Net Torque, lb-ft	295 @ 2400	240 @ 2000 rpm	248 @ 2000 rpm

*Models with GVWR up to 8500 lbs.

**Models with GVWR of 8501 and above.

**SPORTVAN/RALLY
GVWR SELECTOR—ALL STATES
G20/2500 SERIES**

GVW Rating (lbs)	†GAWR (lbs)		Minimum Equipment Required for GVW Rating		
	Front	Rear	Tire Capacity (lbs ea)		Chassis Equipment
			Front	Rear	
6600	3400	3400	1703	1703	Standard (Gasoline Models)
6850	3670	3400	1843	1843	Standard (Diesel Models)

†GAWR's shown are the maximum for each axle with equipment listed. Other GAWR's are available, and they are determined as the minimum capacity of either axle, springs or tires.

**FRONT AND REAR TIRE AVAILABILITY CHART—ALL STATES
G20/2500 SERIES**

Spare tire to match either front or rear tires is available at extra cost.

Description	Capacity (lbs ea)	Highway		Spare
		Front	Rear	
TUBELESS (Requires LB4, LO3 or LOS engine)				
P225/75R15 Steel Belted Radial	1703	XET	YET	ZET
P225/75R15 Whitewall Steel Belted Radial	1703	XEU	YEU	ZEU
P225/75R15 White Letter Steel Belted Radial	1703	XEV	YEV	ZEV
TUBELESS (Requires LH6 engine)				
P235/75R15 Steel Belted Radial	1843	XFL	YFL	ZFL
P235/75R15 Whitewall Steel Belted Radial	1843	XFM	YFM	ZFM
P235/75R15 White Letter Steel Belted Radial	1843	XFN	YFN	ZFN

**GVWR SELECTOR—ALL STATES
G30/3500 SERIES**

GVW Rating (lbs)	†GAWR (lbs)		Minimum Equipment Required for GVW Rating		
	Front	Rear	Tire Capacity (lbs ea)		Chassis Equipment
			Front	Rear	
Δ7400	3400	4200	2350	2350	Standard

ΔRequires LO5 V8 engine.

G30/3500/C6P SERIES

GVW Rating (lbs)	†GAWR (lbs)		Minimum Equipment Required for GVW Rating		
	Front	Rear	Tire Capacity (lbs ea)		Chassis Equipment
			Front	Rear	
8600	3900	5360	2680	2680	Standard

†GAWR's shown are the maximum for each axle with equipment listed. Other GAWR's are available, and they are determined as the minimum capacity of either axle, springs or tires.

FRONT AND REAR TIRE AVAILABILITY CHART—ALL STATES

G30/3500 SERIES

Spare tire to match either front or rear tires is available at extra cost.

Description	Capacity (lbs ea)	Highway		Spare
		Front	Rear	
TUBELESS (Requires LOS engine)				
8.75R-16.5D Steel Belted Radial	2350	XRU	YRU	ZRU
TUBELESS (Requires LO5 or LL4 engine)				
★ 8.75-16.5E Nylon Bias Ply	2680	XTH	YTH	ZTH
★ 8.75R-16.5E Steel Belted Radial	2680	XVD	YVD	ZVD

★Requires C6P model.

SPORTVAN/RALLY

THE FOLLOWING EQUIPMENT IS STANDARD ON DIESEL ENGINE MODELS (ALSO SEE STANDARD SPECIFICATIONS PAGES)

- Low Coolant Sensor
- Poly-wrapped Paper Element Air Cleaner
- Power Steering
- Engine Block Heater (600 watts, 120 volts)
- Water/fuel separator unit which incorporates a water sensor and sending unit, a fuel filter, a fuel heater and water drain capability
- Hydraulic Power-assisted Brakes
- K81 66-amp Generator
- Engine Oil Cooler (located in radiator tank)
- Dual 540 Cold Cranking Amp/115 min. Reserve Capacity Batteries
- HD Radiator
- Dual Exhaust System
- Warning Lights: Glow Plugs, Water-in-fuel (or fuel filter), and Low Coolant
- Diesel Engine Identification:
 - Fender nameplates
 - LH rear door nameplate
 - "Diesel Fuel Only" filler cap and label
- Additional Insulation:
 - Fiberglass/aluminum engine cover and engine cover extension insulators
 - Special mastic/fibre front floor insulators
 - Front floor mats which extend under seats
 - Interior compartment dash panel insulation
 - Engine compartment dash panel insulation
 - Hush panels under instrument panel
 - Extra-thick foam-backed cloth headliner for Bonaventure/Rally Custom and Beauville/Rally STX models
 - Engine hood insulation
 - Special rubber seal at cowl

SPORTVAN/RALLY

**CAB & BODY FEATURES
BODY CONSTRUCTION
SEATING ARRANGEMENTS
COLOR & TRIM CHARTS
TWO-TONES**

SPORTVAN/RALLY

STANDARD MODEL—BODY ORDERING CODE ZW9

The standard model includes the following items as standard equipment

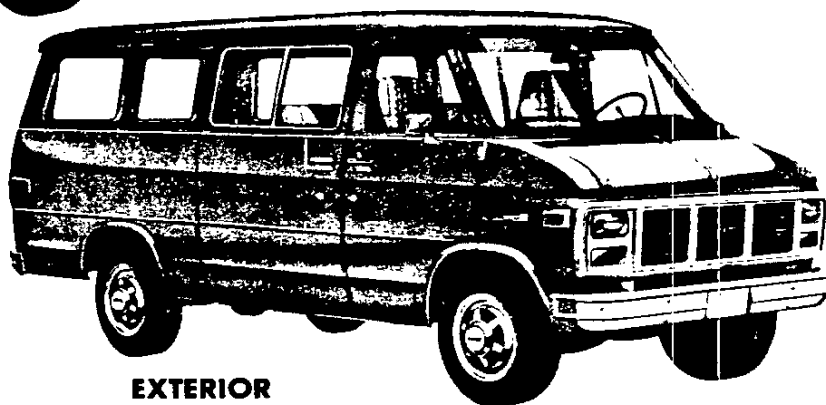

EXTERIOR

- **Bumpers:** Front and rear; painted silver
- **Colors:** See Interior and Exterior Color Selection Chart
- **Doors:** RH and LH front side doors; RH and LH rear load doors; a RH sliding side load door is standard, however, hinged RH side loading doors are available
- **Door Opening and Locking Methods:**
 - Front side doors: Outside pushbutton latch release in door handle with separate key lock; keyless outside locking
 - Sliding side load door: Turning outside handle counterclockwise releases both front and rear latches; to close door, reverse procedure; for opening and closing of door from inside, reverse outside procedure; door is locked from outside through a separate key lock
 - RH and LH rear doors: Pushbutton latch release in RH door handle opens door, and after opening RH door, LH door latch is released by lower inside lift handle; separate key lock cylinder in RH door
- **Glass:**
 - Windshield
 - RH and LH front side door drop glass and pivoting ventpanes with pushbutton locks
 - Double flip-out glass in sliding side door and same on opposite side; bright frames
 - Stationary glass in each rear-quarter window and rear door
- **Grille:** Molded plastic; painted light argent; integral Chevrolet emblem/GMC letters at center
- **Grille Frame:** Headlamp parking-lamp bezels plus upper and lower moldings joining extensions of lamp bezels; painted light argent
- **Horns:** Dual, electric, low- and high-note
- **Hub Caps:** Bright metal with black trim
- **Keys:** Two-key system, with separate keys for ignition switch and door locks
- **Lights:**
 - Backup lamps: Two rear (integral with taillamps)
 - Combination parking/direction/hazard: Two front
 - Combination tail/stop/direction/hazard: Two rear
 - Headlamps: Two; Rectangular
 - License plate lamp: Single rear
 - Side marker lamps and reflectors: Two front and two rear

- **Mirrors:** RH and LH chrome; fixed arm with adjustable 4½" x 6" head
- **Nameplates:** Bright "Sportvan/Rally" plates on front fenders; bright "Chevrolet/GMC letters" plate on LH rear door
- **Tools:** Mechanical jack and wheel wrench
- **Undercoating:** On body rocker panels, step panels, and wheel-housings
- **Wheels:** Painted white
- **Windshield Wipers and Washers:** Electric, 2-speed wipers with black finish on exposed metal portions; wet-arm design demand-type washer system

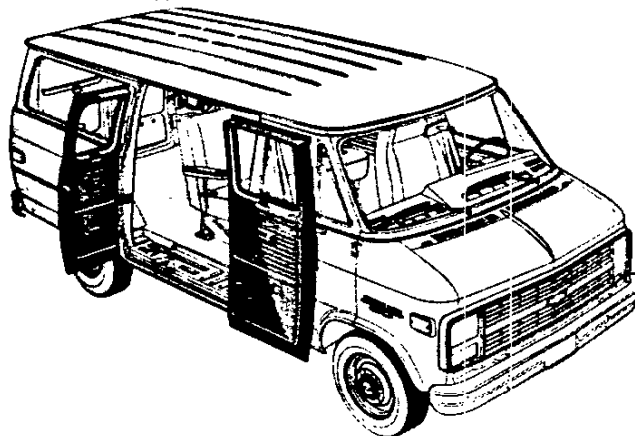

SIDE SWING OUT DOORS—RPO E24

These hinged double side doors are available at no extra cost to replace the standard sliding side door. They feature stainless steel hinge pins and galvanized steel outer panels. The forward door is approximately 12 inches wider than the rearward door to provide a wide opening for cargo or passengers when only the forward door is opened.

SPORTVAN/RALLY

STANDARD MODEL—BODY ORDERING CODE ZW9

The standard model includes the following items as standard equipment

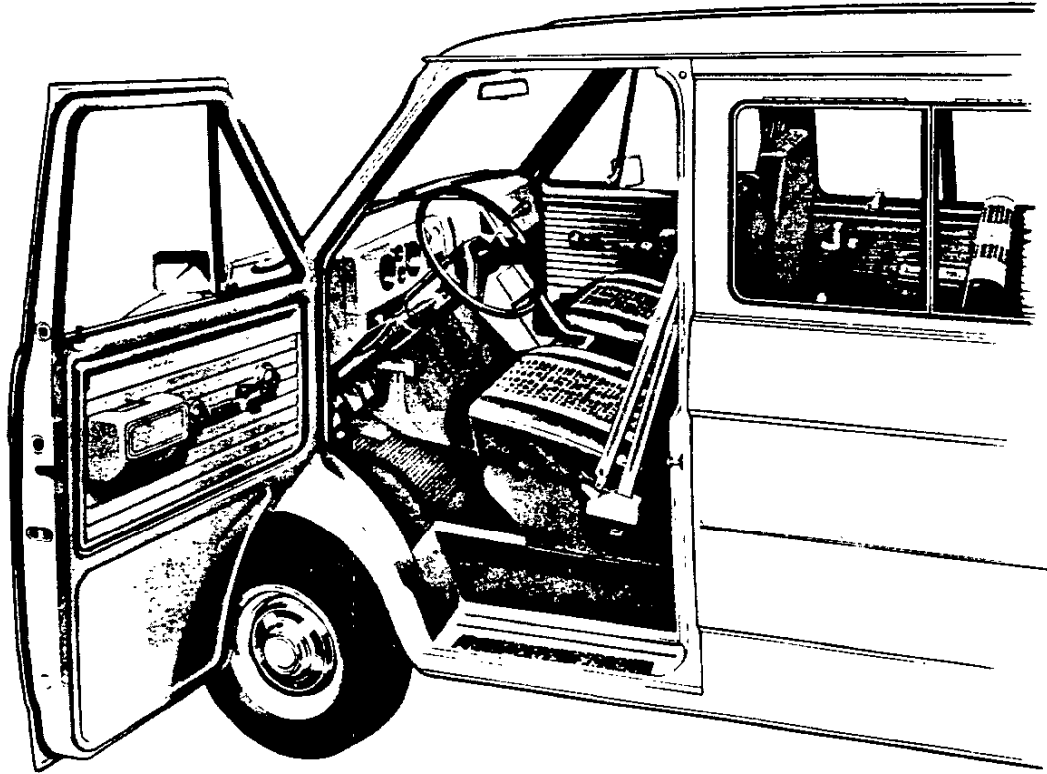

INTERIOR

- **Air Vents:** RH and LH; individually controlled
- **Armrests:** RH and LH side door and rear seat; padded
- **Ashtrays:** At top of instrument panel extension, with door. In rear seat armrests; with covers
- **Coat Hook:** LH side
- **Colors:**
 - Painted areas: Same as exterior primary color choice
 - Interior trim: Coordinated with seat trim color choice
- **Dome Lamps:** Two; with front door-actuated switches (dome lamps may also be activated by main light switch)
- **Door Locks:** Inside pushbutton lock/release for front doors; rotating locking knob for sliding side door
- **Door Seals:** Latex foam rubber
- **Floor Covering:** Embossed black rubber mats; over entire floor area and front wheelhousings
- **Headliner:** Mystic-colored perforated hardboard; driver area
- **Heater and Defogger:** Deluxe-air
- **Hood Lock Release:** Handle located on LH side of instrument panel
- **Instruments:**
 - Gages: Speedometer, odometer, and fuel
 - Switches: Main, for control of exterior lights, instrument lights and dome lights; multi-function switch on steering column for direction signals by moving lever up or down (includes lane change position), headlight beams by pulling lever toward driver, windshield wiper by turning band marked "WIPER" toward or away from driver, and windshield washer by pushing in the lever knob; ignition with key-in warning buzzer; hazard warning; heater fan; door-operated dome lamp
 - Warning lights: Generator, oil pressure, engine temperature, service-parking brake, direction/hazard signal, and high beam
- **Instrument Panel:** Bright trim on gage bezels; black applique with bright trim on area below instrument cluster
- **Insulation and Sound Deadening Material:** Dash (firewall), entire floor panel, engine cover front extension, and inside engine cover
- **Lights:** Instruments, front and rear dome
- **Main Light Switch Control Knob:** Bright, with brushed finish and black graphic identification
- **Mirror:** 10"; vinyl-edged prismatic
- **Parcel Tray:** On top surface of instrument panel extension; includes beverage holder provisions
- **Safety Step Pads:** Front and rear side door step panels
- **Seat Belts:** Color-keyed with pushbutton release; driver, front passenger and all rear seat positions; outboard retractors for driver and front passenger
- **Seats:** Front, adjustable high-back bucket driver and passenger; rear quick release, removable 3-passenger; all-vinyl trim; foam padded (G30/3500 models without C6P have 2 additional quick release, removable rear seats for 12 passenger seating. See page D). Also available at extra cost: all-vinyl leather grained trim. See Interior and Exterior Color Selection Chart for color and trim availability
- **Spare Tire Carrier:** RH rear side
- **Steering Wheel and Column:** 15.25" diameter black soft vinyl wheel with 2 spokes; black energy-absorbing steering column with anti-theft locking feature
- **Storage Box:** In front face of instrument panel extension; with latched door
- **Sunshades:** RH and LH padded, color keyed
- **Trim Panels:** Painted metal with decorative embossments; front and rear side doors

SPORTVAN/RALLY

G30/3500 WITHOUT C6P HEAVY DUTY CHASSIS

STANDARD MODEL

This model includes all items listed on pages B & C plus the following additions or substitutions
(See page 4 for chassis standard equipment differences)



- **Seats:** In addition to the driver and passenger front high bucket seats and the 3-passenger center seat, this model includes as standard equipment RPO AQ4—Two additional rear seats, which provide 12-passenger seating. All passenger seats (except front high-back bucket) are the quick-release, removable type, with all-vinyl trim that matches the front seats.

- **7400-lb GVW Rating**



NOTES

SPORTVAN/RALLY

BONAVENTURE/RALLY CUSTOM SPORTVAN MODEL—BODY ORDERING CODE ZM2

This option includes all exterior items listed for the standard model plus the following additions or substitutions



Chevrolet model shown (GMC model available)

EXTERIOR

- **Bright Appearance Items:**
 - "Bonaventure/Rally Custom" nameplates, on front fenders
 - Front and rear bumpers
 - Upper and lower grille outline moldings
 - Bright applied Chevrolet emblem/GMC letters at grille center
- **Grille:** Chevrolet—Argent with bright applied Chevrolet emblem
GMC—Light argent with dark argent air intake areas and bright applied GMC letters with red paint fill
- **Grille Frame:** Light argent headlamp/parking lamp bezels with argent centers and bright outboard perimeter moldings; bright upper and lower grille outline moldings

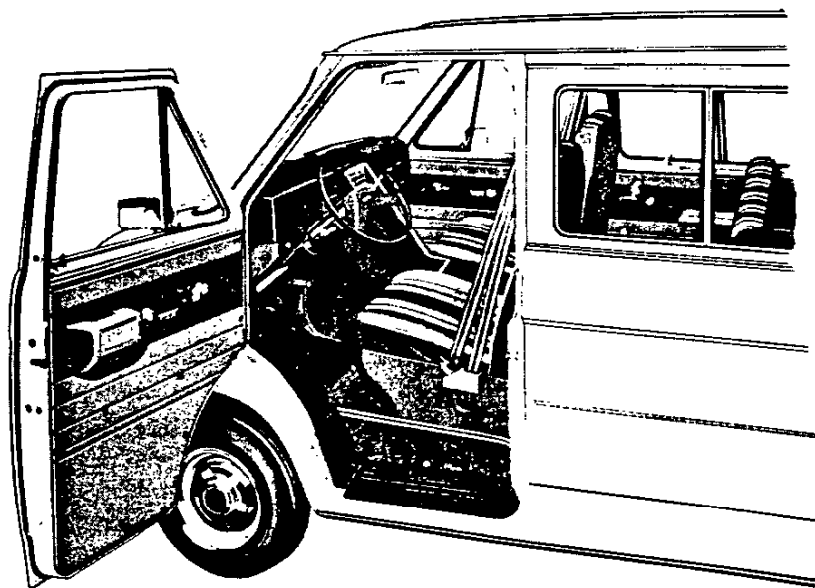

INTERIOR

- **Bright Appearance Items:**
 - "Bonaventure/Rally Custom" lettering and trim on applique at RH side of instrument panel
 - Trim moldings at center of instrument panel
- **Cigar Lighter:** With ash tray light
- **Coat Hooks:** LH and RH side, above rear-quarter windows; plus one on LH side panel to rear of drivers seat
- **Floor Covering:** Color-keyed rubber mats; for entire floor area, including front and rear wheelhousings
- **Garnish Moldings:** Slate or saddle tan colored plastic moldings for rear compartment side windows, front and rear roof header panels, roof front side rails and windshield pillars, front door lock pillars, lower sliding door hinge pillar, and sliding door track and roller bracket
- **Headliner:** Full-length, slate or saddle tan colored; foam-backed cloth
- **Deluxe Instrument Panel:** Two-tone color treatment; color-keyed instrument cluster bezel; woodgrain applique and bright trim with woodgrain insert for central area; black applique with bright trim and Bonaventure/Rally Custom lettering on RH side
- **Insulation:** Above headliner and on wheelhousing areas
- **Seats:** High-backed driver and front passenger bucket seats and standard rear passenger seat with leather grained all-vinyl trim. See Interior and Exterior Color Selector Chart for color and trim availability
- **Spare Tire Cover:** G1 models—black vinyl; G2-3 models—color-keyed carpet type
- **Trim Panels:** Colored-keyed, vinyl-coated, embossed hardboard on doors and sidewalls

SPORTVAN/RALLY

BEAUVILLE SPORTVAN/RALLY STX MODEL—BODY ORDERING CODE E94

This model includes all items listed for Bonaventure/Rally Custom model option plus the following additions or substitutions



GMC model shown (Chevrolet model available)

EXTERIOR

- **Bright Appearance Items:**
 - "Beauville/Rally STX" nameplates, on front fenders
 - Body side and rear upper moldings with black paint trim
 - Wheel opening lip moldings
 - Front door ventipane posts
- **Grille:** Chevrolet—Bright center bar moldings with body color
 - paint fill
- **Headlamp Bezels:** Chevrolet—Bright center bar moldings with body color paint fill
 - GMC—Center bars painted light argent
- **Special Headlamps:** Rectangular; dual RH and LH
- **Special Side Marker Lamps and Reflectors:** RH and LH front and rear

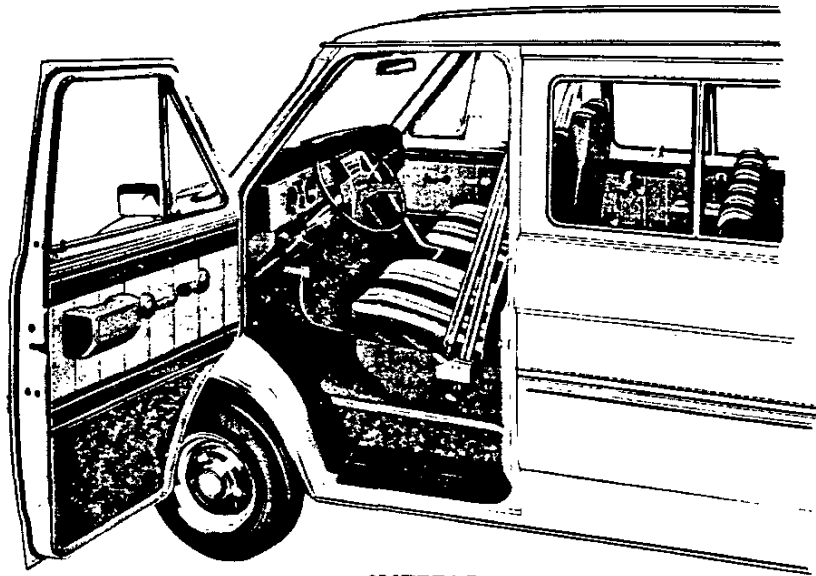

INTERIOR

- **Bright Appearance Items:**
 - "Beauville/Rally STX" lettering and trim on RH instrument panel trim plate
 - Trim on door and sidewall trim panels
- **Enclosure Panels:** Color-keyed plastic trim panels to conceal rear seat armrest supports and seat risers
- **Floor Covering:** Color-keyed carpeting; over entire floor area including front and rear wheel housings; lower portion of engine cover and vertical walls of front and rear side door stepwells
- **Garnish Moldings:** Color-keyed to seat trim color
- **Headliner:** Color-keyed to seat trim color
- **Instrument Cluster Bezel:** With woodgrain applique
- **Insulation:** Under instrument panel upper extension; behind door and sidewall trim panels
- **Seats:** High-backed driver and front passenger bucket seats, and standard rear passenger seat with choice of: 1) dual-tone striped vinyl trim; or 2) ribbed pattern velour cloth/vinyl trim. See Interior and Exterior Color Selection Chart for color and trim availability.
- **Stepwell Mats:** Embossed black rubber mats for top surface of front and rear side door stepwells
- **Trim Panels:** Embossed, color-keyed vinyl on doors and sidewalls with styling coordinated with seat trim and carpeting on lower areas
- **Visor Mirror:** On RH sun visor

SPORTVAN/RALLY

BODY CONSTRUCTION FEATURES

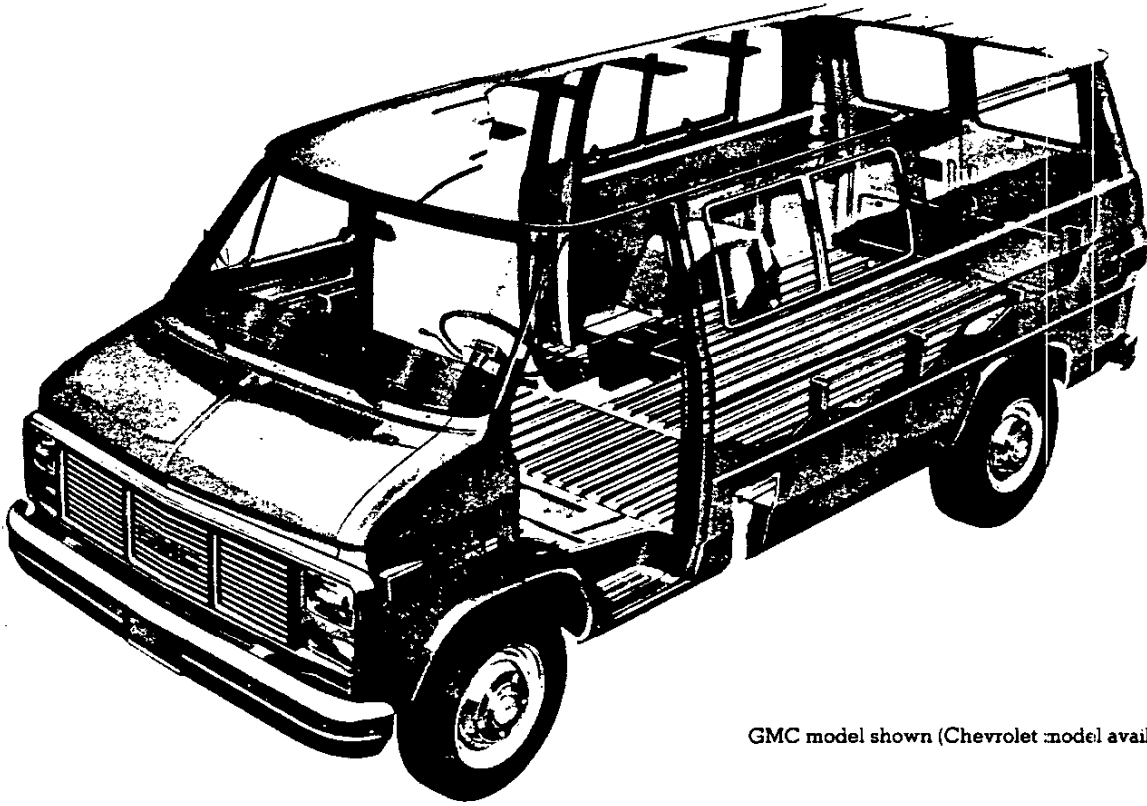

GMC model shown (Chevrolet model available)

The all-steel, Chevy Van/Vandura and Sportvan/Rally bodies feature body-frame integral construction for outstanding structural rigidity and excellent durability. The basic bodies of either the nominal 15 foot (110" WB) or 17 foot (125" WB) models are comprised of an underbody structure, front end structure, left and right hand side panel structures, and a roof panel structure.

Longitudinal side rails, cross sills, and outriggers form the integral frame to which front and rear floor panels are welded, completing the underbody structure. Main structural members are of heavy-gage steel. A step well is incorporated in the underbody in the area adjacent to the front doors and sliding side door to provide convenient entry and exit.

The front end structure incorporates an engine compartment with outside opening hood panel which affords quick and easy access to 27 service points, such as the engine, radiator, battery, brake master cylinder and windshield washer reservoir. The radiator support upper tie bar and baffles are mechanically attached to facilitate engine removal. A plenum chamber with high-level air intake is utilized in the front end structure to assure a plentiful supply of dry, outside air for interior heating and ventilating as well as to add rigidity to the overall body structure. Air outlets to the interior are provided on the left hand and right hand sides by manually controlled doors (RH door omitted with optional air conditioning).

Side panel structures are comprised basically of seamless, one-piece outer panels reinforced with vertical strainers and welded to roof rails at the top and to rocker panels at the bottom. Left hand side panel structures utilize three vertical strainers, with a fourth strainer added for 17-foot bodies. Right hand side panel structures, which are smaller because of the provision for the base side load door, are reinforced with one vertical strainer in 15-foot body applications and two strainers in 17-foot body applications. Two window openings are incorporated in the left hand side panel for all Sportvans/Rally, or for Chevy Vans/Vandura with RPO A07 body glass; one window is incorporated for Chevy Vans/Vandura with RPO A17 body glass. The right hand side panel for Sportvan/Rally models, or Chevy Van/Vandura with RPO A07 or A08 body glass, has one window. Provision is made at the rear of the left hand side panel for incorporation of a door to conceal the fuel tank filler.

Roof panels are of one-piece design and are embossed with six longitudinal stiffening ribs. Four roof bows support the 15-foot body roof panel, while five roof bows are used for the 17-foot body.

Special attention is given to corrosion prevention during the construction and final finishing of the body. The following body design features occur during the construction of the body:

1. Use of special steel (galvanized, zinc iron alloy, zinc coated) for body components especially subject to corrosion.
2. Use of one-piece outer panels to minimize exterior joints where corrosion might occur.
3. Use of heavy-gage steel for main underbody components.
4. Use of weld-through sealers in the assembly process to assure strong welds.

After body construction is completed, additional corrosion preventative steps are taken in the final finishing operation. The following occur:

1. The body, doors and hood are thoroughly cleaned by processing them through a 7-stage zinc phosphate washer.
2. Next, the body, doors and hood are primed by the Elpo electro-coating process which is the deposition of an electrically charged colloidal paint using an electric current. Electro-coating assures uniform application of primer even on surfaces normally inaccessible. In the process, the body, doors and hood are submerged in an emulsion of water and paint; the body, doors and hood and the emulsion are then oppositely charged, causing the paint to adhere to the metal.
3. Sealers are then applied to all critical interior-exterior joints.
4. Undercoating is sprayed on the undersurfaces of the wheel-housings, front door step panels and body rocker panels.
5. The body, doors and hood are painted with enamel.
6. A sealer pad is installed on the top surface of the floor panel at the left hand side, and is bonded to the floor panel as the body bakes in the topcoat oven.
7. The lower inside surfaces of the doors and rocker panels are sprayed with aluminum wax preservative.
8. A protective coating is applied to the front door hinge pins.
9. Finally, an anti-chip coating is added which extends from the rear of the front wheel openings to the rear door openings to prevent stone chipping.

SPORTVAN/RALLY

SPORTVAN/RALLY SEATING ARRANGEMENTS

Seating arrangement for standard and RPO AQ3/AQ4/B6S seats.
For model availability see model option price pages.

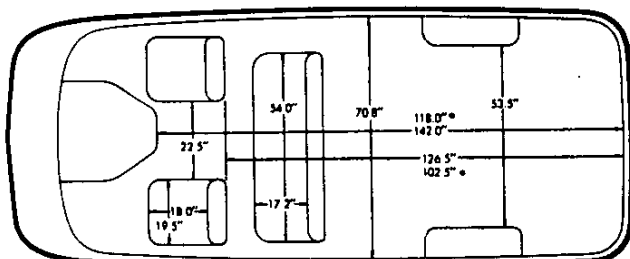
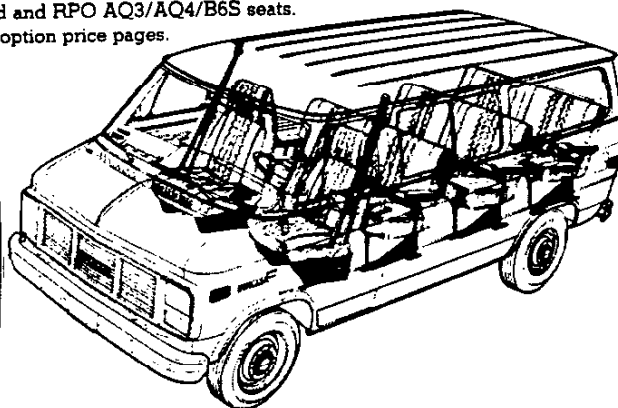

**STANDARD 5-PASSENGER SEATING (125" WB)
*110" WB MODELS**

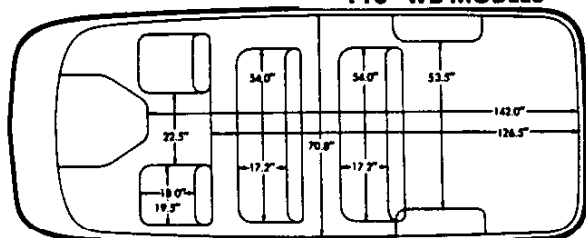

OPTIONAL 8-PASSENGER SEATING (125" WB)

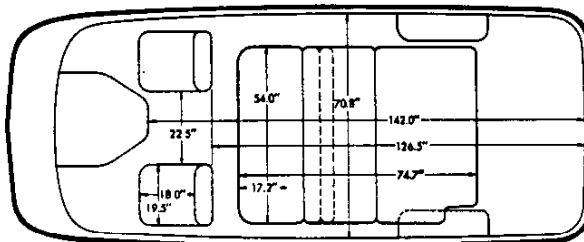

**OPTIONAL TRAVEL BED REPLACING CENTER SEAT
(PROVIDES 5-PASSENGER SEATING)**

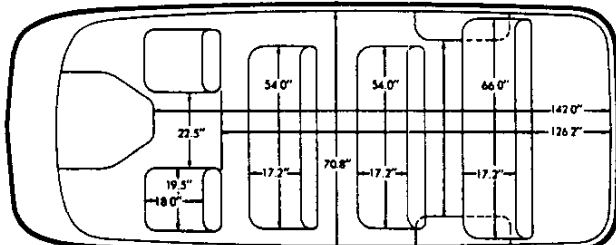

**OPTIONAL 12-PASSENGER SEATING (G30 ONLY)
(STANDARD W/O C6P)**

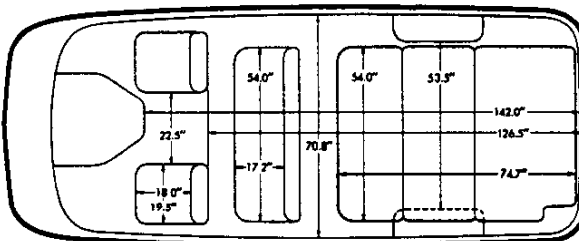

**OPTIONAL TRAVEL BED REPLACING 3RD SEAT
(PROVIDES 8-PASSENGER SEATING)**

INSTRUMENTS

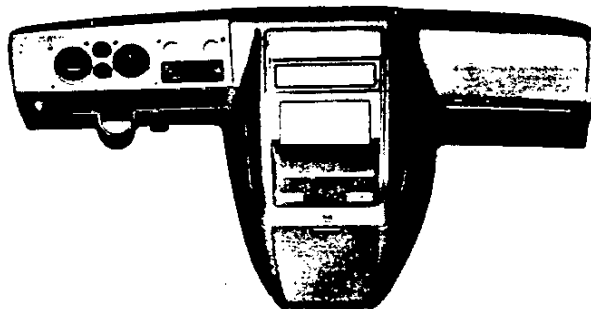

The standard instrument cluster gages and heater controls are set into the molded plastic instrument panel and have bright bezels. The large LH opening contains the speedometer, odometer, high beam indicator, and service-parking brake warning light. Diesel engine models will also have warning lights for low coolant, glow plugs and water-in-fuel.

The large RH opening contains the fuel gage with a graphic symbol. An "Unleaded Fuel Only" notation is carried on the face of the fuel gage for models which require this fuel. The upper small opening between these two large openings houses the warning lights with graphic symbols for temperature, low oil pressure and generator. The lower opening is provided to house the RPO U35 electric clock.

On the upper RH side the two small openings are provided to house the controls for the RPO C36 rear heater (LH) and the RPO C69 rear air conditioner (RH). Below these openings are the heater/defogger and optional front air conditioner controls with graphic symbols for the fan and defogger. A similar instrument cluster with voltmeter, oil pressure gage and engine temperature gage is available as RPO Z53.

The area below the instrument cluster contains, from left to right, the windshield washer/wiper switch, with graphic symbol, main light switch, and ignition switch. This lower area has a black applique with bright trim. At the far left is the provision for the LH front air conditioner air outlet.

SPORTVAN/RALLY

INTERIOR AND EXTERIOR COLOR AVAILABILITY CHART

Note: Below are the interior trim color and exterior paint combinations recommended by Chevrolet/GMC. The only available color code 1/color code 2 exterior color combinations are shown in the chart below; however, any available interior trim color may be ordered with one of these exterior color combinations if that particular combination is desired by the customer.

TRIM LEVEL Seat Type	Model Option	INTERIOR COLORS					STRIPE COLOR w/D85	
		Blue	Burgundy	Mahogany	Saddle Tan	Slate Gray		
STANDARD INTERIOR Vinyl High Back Bucket Seats Custom Vinyl High Back Bucket Seats	S10	VDD4			VSS4			
		XDD4			XSS4			
BONAVENTURE/RALLY CUSTOM (N/A G11006) Custom Vinyl High Back Bucket Seats	ZM2	XDD4	XEE4		XSS4	XTT4		
BEAUVILLE/RALLY STX (N/A G11006) Custom Vinyl High Back Bucket Seats Custom Cloth High Back Bucket Seats Custom Cloth Reclining Bucket Seats	E94	XDD4 KDD4 KDD6	XEE4 KEE4 KEE6		XSS4 KSS4 KSS6	XTT4 KTT4 KTT6		
EXTERIOR COLORS w/ZY1, ZY3 or ZY4 PAINT	Color Code 1	Color Code 2	RECOMMENDED INTERIOR TRIM COLORS					STRIPE COLOR w/D85
BLUE, LIGHT (Metallic)	21	21	X				X	Light Blue/Dark Blue
Blue, Galaxy (Metallic)	21	28	X					Light Blue/Dark Blue
White, Frost	21	12	X					Light Blue/Dark Blue
BLUE, GALAXY (Metallic)	28	28	X				X	Light Blue/Dark Blue
Blue, Light (Metallic)	28	21	X				X	Light Blue/Dark Blue
White, Frost	28	12	X					Light Blue/Dark Blue
BRONZE, INDIAN (Metallic)	66	66			X	X		Doeskin/Dark Brown
Champagne (Metallic)	66	62			X	X		Doeskin/Dark Brown
Gold, Nevada (Metallic)	66	67			X	X		Doeskin/Dark Brown
Tan, Doeskin	66	61			X	X		Doeskin/Dark Brown
White, Frost	66	12			X	X		Doeskin/Dark Brown
BURGUNDY (Metallic)	78	78		X				Doeskin/Dark Carmine
Champagne (Metallic)	78	62		X		X		Doeskin/Dark Carmine
Gold, Nevada (Metallic)	78	67		X		X		Doeskin/Dark Carmine
Gray, Steel (Metallic)	78	90		X				Doeskin/Dark Carmine
Tan, Doeskin	78	61		X		X		Doeskin/Dark Carmine
White, Frost	78	12		X				Doeskin/Dark Carmine
CHAMPAGNE (Metallic)	62	62			X	X		Dark Brown/Doeskin
Bronze, Indian (Metallic)	62	66			X	X		Doeskin/Dark Brown
Burgundy (Metallic)	62	78			X			Vermillion/Dark Carmine
Gold, Nevada (Metallic)	62	67			X	X		Dark Brown/Doeskin
Red, Apple	62	72			X	X		Vermillion/Dark Carmine
White, Frost	62	12			X	X		Dark Brown/Doeskin
TAN, DOESKIN	61	61			X	X		Doeskin/Dark Brown
Bronze, Indian (Metallic)	61	66			X	X		Doeskin/Dark Brown
Burgundy (Metallic)	61	78			X			Doeskin/Dark Brown
Red, Apple	61	72			X	X		Dark Brown/Doeskin
White, Frost	61	12			X	X		Dark Brown/Doeskin
GOLD, NEVADA (Metallic)	67	67			X	X		Doeskin/Dark Brown
Blue, Galaxy (Metallic)	67	28				X		Doeskin/Dark Brown
Bronze, Indian (Metallic)	67	66				X		Doeskin/Dark Brown
Burgundy (Metallic)	67	78			X			Doeskin/Dark Brown
Champagne (Metallic)	67	62			X	X		Dark Brown/Doeskin
Red, Apple	67	72			X	X		Dark Brown/Doeskin
Tan, Doeskin	67	61			X	X		Doeskin/Dark Brown
GRAY, STEEL (Metallic)	90	90	X				X	Light Blue/Dark Blue
GRAY, STEEL (Metallic)	90	90		X				Vermillion/Dark Carmine
Blue, Galaxy (Metallic)	90	28	X					Light Blue/Dark Blue
Blue, Light (Metallic)	90 -	21	X					Light Blue/Dark Blue
Red, Apple	90	72		X				Vermillion/Dark Carmine
White, Frost	90	12	X				X	Light Blue/Dark Blue
White, Frost	90	12		X				Vermillion/Dark Carmine
RED, APPLE	72	72		X		Y		Vermillion/Dark Carmine
Champagne (Metallic)	72	62		X				Vermillion/Dark Carmine
Burgundy (Metallic)	72	78		X				Vermillion/Dark Carmine
Gold, Nevada (Metallic)	72	67			X	X		Vermillion/Dark Carmine
Tan, Doeskin	72	61			X	X		Vermillion/Dark Carmine
White, Frost	72	12		X				Vermillion/Dark Carmine
WHITE, FROST	12	12	X					Light Blue/Dark Blue
WHITE, FROST	12	12		X				Doeskin/Dark Carmine
WHITE, FROST	12	12			X			Doeskin/Dark Brown
WHITE, FROST	12	12				X		Dark Brown/Doeskin
WHITE, FROST	12	12					X	Vermillion/Black
Blue, Galaxy (Metallic)	12	28	X				X	Light Blue/Dark Blue
Blue, Light (Metallic)	12	21	X					Light Blue/Dark Blue
Burgundy (Metallic)	12	78		X				Vermillion/Dark Carmine
Champagne (Metallic)	12	62			X	X		Dark Brown/Doeskin
Red, Apple	12	72		X				Vermillion/Dark Carmine
Red, Apple	12	72				X		Doeskin/Dark Carmine
w/ZY5 PAINT (Interior & Exterior Combinations Shown are the Only Combinations Available)								STRIPE COLOR
BLUE, LIGHT (Met)/Gray, Steel (Met)	21	90	X					Light Blue/Dark Blue
BLUE, GALAXY (Met)/Gray, Steel (Met)	28	90	X					Light Blue/Dark Blue
BRONZE, INDIAN (Met)/White, Frost	66	12			X			Dark Brown/Doeskin
BRONZE, INDIAN (Met)/Tan, Doeskin	66	61			X	X		Dark Brown/Doeskin
GRAY, STEEL (Met)/Blue, Light (Met)	90	21	X					Light Blue/Dark Blue
GRAY, STEEL (Met)/Red, Apple	90	72					X	Vermillion/Dark Carmine
RED, APPLE/Gray, Steel (Met)	72	90		X				Vermillion/Dark Carmine
RED, APPLE/Champagne (Met)	72	62		X		X		Vermillion/Dark Carmine

SPORTVAN/RALLY

SOLID AND TWO-TONE* EXTERIOR COLOR COMBINATIONS

The application of paint for solid and two-tone exterior color combinations is shown below.



GMC model shown
(Chevrolet model available)

Solid color paint (ZY1) is standard on all models. All painted areas of the body are the same color.

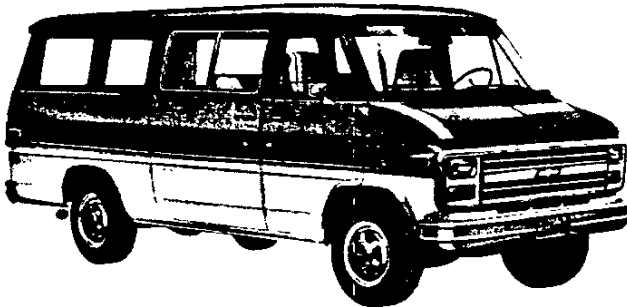

Chevrolet model shown (GMC model available)

Special two-tone (ZY3) paint colors include black body side and rear moldings with bright trim (except with the Beauville/Rally STX model where bright body side and rear moldings with black trim are already included). Color code 1 is applied to the areas above the moldings. Color code 2 is applied to the areas below the moldings.

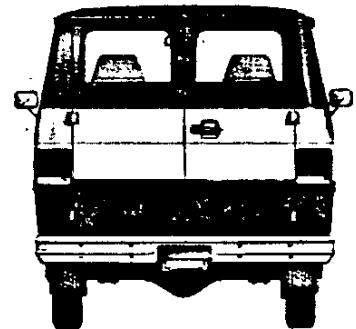
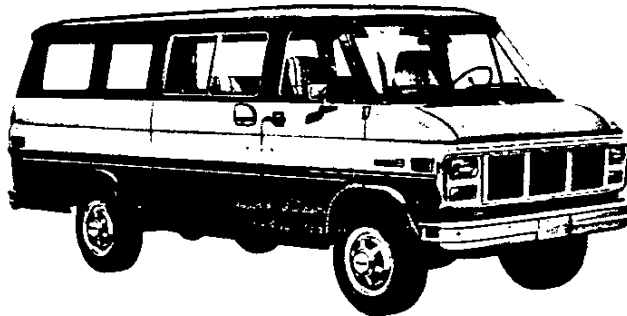

GMC model shown (Chevrolet model available)

Deluxe two-tone (ZY4) paint colors include black body side and rear moldings with bright trim (except with the Beauville/Rally STX model where bright body side and rear moldings with black trim are already included). Color code 1 is applied to the areas above the belt line styling crease line and below the moldings. Color code 2 is applied to the areas between the belt line styling crease line and the moldings.

*Optional at extra cost.

SPORTVAN/RALLY

SOLID AND TWO-TONE* EXTERIOR COLOR COMBINATIONS

The application of paint for solid and two-tone exterior color combinations is shown below.



Chevrolet model shown (GMC model available)

EXTERIOR DECOR PACKAGE

Exterior Decor Package (ZY5) paint colors and trim are available in a choice of eight combinations (see Interior and Exterior Color Availability Chart). The package includes black body side and rear moldings with bright trim plus bright wheel opening moldings, (except with the Beauville/Rally STX model where bright wheel opening moldings, and bright body side and rear moldings with black trim are already included). In addition, it includes dual-tone tape decal striping keyed to the interior trim and exterior body colors. This striping is applied just below the windows on the belt line crease.

The roof area above the drip rails and the area between the tape decal striping and the moldings are painted color code 1. The roof drip rails and the areas between the roof drip rails and the tape decal striping and below the moldings are painted color code 2.

*Optional at extra cost.