

ASTRO/SAFARI SL
 (Passenger Van)
ASTRO/SAFARI SL PASSENGER VAN MODEL SELECTOR

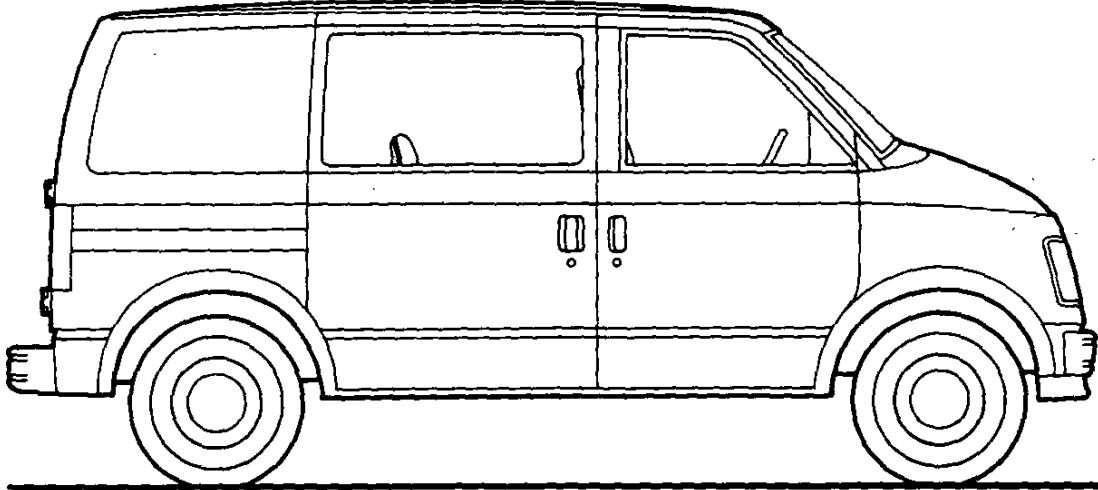

SERIES	MODEL NUMBER	BODY ORDERING CODE		
		ASTRO CS/ SAFARI SLX	ASTRO CL/ SAFARI SLE	ASTRO LT/ SAFARI SLT
M10	M10906	ZW9	YC6	YC7

ASTRO/SAFARI SL

(Passenger Van)

STANDARD SPECIFICATIONS

(See Gray Tab Section for Specification Details)

Series	M10
Engine Base Equip. Clutch Air Filter Oil Filter Exhaust System Emission Control Systems	4.3 Liter (262 Cu. In.), EFI V6 11"; 124 sq. in. Oiled-paper Element Throwaway Type Single Aluminized See Engine & Cooling Section for specific model applications
Suspension, Front Type Axle Capacity Axle Ratio Springs @ Ground Shock Absorbers Stabilizer Bar	Independent Coil Springs 2700 lb. — 1350 lb. ea. 25mm dia. 32mm
Suspension, Rear Type Axle Capacity Axle Ratio Springs, Main @ Ground Shock Absorbers	Salisbury Axle; Hypoid Drive; Variable Rate Leaf Springs Composite Single Leaf Springs 2900 lb. 3.73 1450 lb. ea. 25mm dia.
Brakes Front Rear Booster Parking	Hydraulic; Self-adjusting Disc; 12" Rotor Drum; 9.49" x 2" Single Diaphragm Cable to Rear Wheels
Electrical Battery – Freedom Type – Reserve Capacity Delcotron Generator	12 Volt; Negative Ground 525 CCA ♦ @ 0°F. 90 min. @ 80°F. 85 amp.
Frame	Integral Body-frame with Box Section Front Stub Frame
Fuel Tank (nominal capacity)	17 gal.
Steering Gear Type Linkage	Manual; Recirculating Ball Gear Parallelogram
Transmission Shift Location	5-Speed Manual w/Overdrive Floor
Tires Spare	(4) P195/75R15 (All Season Steel-Belted Radial) (1) T145/80D16
Wheels Spare	(4) Disc, 15" x 6" (1) Disc, 16" x 4"

♦ CCA-Cold Cranking Amps

ASTRO/SAFARI SL

(Passenger Van)

Body Ordering Codes:

Astro/Safari SL—ZW9

Astro CS/Safari SLX—YC5

Astro CL/Safari SLE—YC6

Astro LT/Safari SLT—YC7

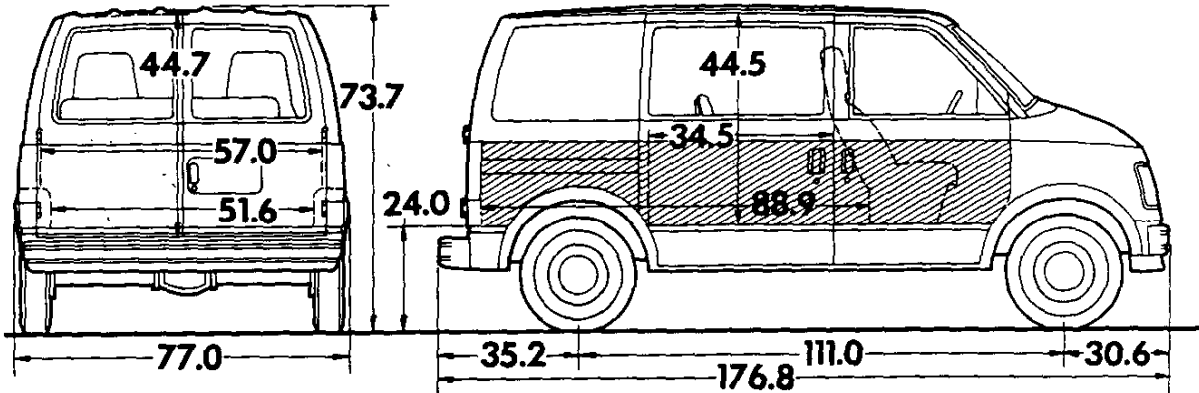

Sign Panel Area (side)

18" x 107"



Capacity (Cu. Ft.)

w/Std. Seating—86.2

w/7- or 8-Pass.—22.7

w/Center Seat Removed—151.8

Model	Body Ordering Code	Engine No. Cyl.	Curb Weight (lb)			Model Weights (lb)*			Ground Clearance (in)*
			Front	Rear	Total	Front	Rear	Total	Minimum
M10906	ZW9	6	2064	1522	3586	2396	1940	4336	7.8
M10906	YC6	6	2091	1546	3637	2423	1963	4386	7.8
M10906	YC7	6	2107	1576	3683	2439	1994	4433	7.8

* Dimensions with standard equipment, unloaded.

*Model Weights include curb weight plus occupants (standard seating capacity x 150 lbs.). Total Weight may vary as much as ± 50 lbs. to allow for production build variation.

SEATING CAPACITY SELECTOR

‡Maximum Ratings				Minimum Equipment Required for GVW Rating		
Seating Capacity	GVW Range (lb)	†GAWR (lb)		Tires, Front	Tires, Rear	Chassis Equipment
		Front	Rear			
M10906 MODELS						
•4, •5	4404 to 5055	2685	2685	P195/75R15	P195/75R15	Standard
	4704 to 5354	2700	2900	P205/75R15	P205/75R15	Increased Cargo Capacity (X6X)
•7	4792 to 5410	2700	2900	P205/75R15	P205/75R15	Standard
•8	4742 to 5439	2700	2900	P205/75R15	P205/75R15	Standard

‡GAWRs shown are the maximum for each axle with the equipment listed. Maximum ratings include an additional 50 lbs. allowance for vehicle weight variance.

†GAWR—Gross Axle Weight Rating.

•Requires ZP4, Four-Passenger or ZP5, Five-Passenger Seating.

•Requires ZP7, Seven-Passenger Seating.

•Requires ZP8, Eight-Passenger Seating.

ASTRO/SAFARI SL

(Passenger Van)

POWER TEAMS

ALL STATES

POWER TEAMS (MUST ORDER ENGINE, TRANSMISSION AND REAR AXLE)

(Consult GVWR Selector and Tire Chart to insure tire capacity and availability)

ENGINE	TRANSMISSION			2.73	3.08	3.23	3.42	3.73	RESTRICTIONS
	5-SP	AUTO							
W/NA6 STANDARD EMISSION EQUIPMENT									
LB4 V6 4.3 Liter EFI	MM5			GQ1	GU4	—	—	—	ZP4/ZP5-X6X
	MM5			—	GQ1	—	GU6	—	ZP7/ZP8/X6X
		MXO		—	—	GQ1	GU6	*GT4	
W/NA6 HIGH ALTITUDE EMISSION EQUIPMENT									
LB4 V6 4.3 Liter EFI	MM5			—	GQ1	—	GU6	—	
		MXO		—	—	GQ1	GU6	*GT4	
W/YF5 CALIFORNIA EMISSION REQUIREMENTS									
LB4 V6 4.3 Liter EFI	MM5			GQ1	GU4	—	—	—	ZP4/ZP5-X6X
	MM5			—	GQ1	—	GU6	—	ZP7/ZP8/X6X
		MXO		—	—	GQ1	GU6	*GT4	

*Reqs 282 Trailing

ENGINE RATINGS—ALL STATES

SAE Net Ratings	4.3 Liter 262 EFI V6
Net Horsepower	150 @ 4000 rpm
Net Torque, lb-ft	230 @ 2400 rpm

ASTRO (PASSENGER VAN)

1988 VEHICLES WITH STANDARD EQUIPMENT

prices shown are effective with vehicles produced on and after January 2, 1988

Description	Model Number	Body Code	Wheel Base	Factory D&H(a)	List Price	Mfr's Suggested Retail Price*	Group Number
◆ 6-Cylinder 4.3 Liter (262 Cu. In.) E.F.I. V6 Gasoline Engine-Engine Ordering Code LB4							
M10 Series							
Astro CS	CM10906	ZW9	111"	N.A.	10696.00	10696.00	13
Astro CL	CM10906	YC6	111"	N.A.	11489.00	11489.00	13
Astro LT	CM10906	YC7	111"	N.A.	12828.00	12828.00	13

★ Manufacturer's Suggested Retail Prices do not include applicable destination charges, state and local taxes, license fees, optional equipment or special items or services.

◆ Refer to Dealer Order Guide for California Requirements.

OPTIONS WHEN INSTALLED BY GENERAL MOTORS

prices shown are effective with vehicles produced on and after January 2, 1988

Description	Option Number	Factory D&H(a)	List Price	Mfr's Suggested Retail Price◇
Seat Trim: (See Interior and Exterior Color Selection Chart for ordering information).				
V**4 Standard Vinyl High Back Bucket. Not available when YC6 or YC7 is specified	NO ADDITIONAL CHARGE		
X**4 Custom Vinyl High Back Bucket. Standard on YC6. Not available when YC7 is specified	...	NO ADDITIONAL CHARGE		
With ZP4 or ZP7 Seating Arrangement	NO ADDITIONAL CHARGE		
With ZP8 Seating Arrangement	N.A.	158.00	158.00
With ZP5 Seating Arrangement	N.A.	106.00	106.00
K**4 Custom Cloth High Back Bucket. Not available when YC7 is specified	...	NO ADDITIONAL CHARGE		
With YC6	NO ADDITIONAL CHARGE		
With ZP4 or ZP7 Seating Arrangement	NO ADDITIONAL CHARGE		
With ZP8 Seating Arrangement	N.A.	158.00	158.00
With ZP5 Seating Arrangement	N.A.	106.00	106.00
L**6 Velour Cloth Reclining Bucket. Standard on YC7	...	NO ADDITIONAL CHARGE		
With ZP4 or ZP7 Seating Arrangement	NO ADDITIONAL CHARGE		
With ZP5 Seating Arrangement	NO ADDITIONAL CHARGE		
With ZP8 Seating Arrangement	NO ADDITIONAL CHARGE		
Paints, Exterior: (See Interior and Exterior Color Selection Chart for Ordering Information and Paint Application).				
Solid	ZY1	NO ADDITIONAL CHARGE		
Special Two-Tone.				
Without YC7. Includes D85 Striping	ZY3	N.A.	251.00	251.00
With YC7	ZY3	N.A.	172.00	172.00
Sport Two-Tone. Not available when YC7 is specified	ZY7	N.A.	172.00	172.00
Emission Systems: Dealer Note - One of the following emission options must be specified. (See Power Teams Chart for availability and complete specifications)				
<i>California Emission Requirements. Includes all testing, equipment and/or certification necessary for registration in the State of California. Not available when NA6 High Altitude or NA5 Standard Emissions is specified.</i>				
.....	YF5	N.A.	99.00	99.00
<i>High Altitude Emission Equipment. Not available when YF5 California Emissions is specified</i>				
.....	NA6	NO ADDITIONAL CHARGE		
<i>Standard Emission Equipment. Not available when YF5 California or NA6 High Altitude Emissions are specified</i>				
.....	NA5	NO ADDITIONAL CHARGE		
Engines: (See Power Teams Chart for availability and complete specifications)				
Gasoline.				
4.3 Liter (262 Cu. In.) E.F.I. V6	LB4	NO ADDITIONAL CHARGE		
Transmissions:				
4-Speed Automatic with Overdrive	MX0	N.A.	550.00	550.00
5-Speed Manual with Overdrive. Standard	MM5	NO ADDITIONAL CHARGE		

(a) D & H Charges on vehicle and optional equipment include reimbursement to ordering Division for any tax that it has paid, incurred or agreed to pay thereon.

◇ State and local taxes not included.

ASTRO/SAFARI (PASSENGER VAN)

OPTIONS WHEN INSTALLED BY GENERAL MOTORS

prices shown are effective with vehicles produced on and after January 2, 1988

Description	Option Number	Factory D&H(a)	List Price	Mfr's Suggested Retail Price◇
Axles, Rear: (See Power Teams Chart for option number selection, availability and complete specifications)				
<i>Optional Ratio</i>		N.A.	38.00	38.00
<i>Locking Differential</i> Includes T155/90 D16 Compact Spare	G80	N.A.	252.00	252.00
Tires:				
<i>All rim sizes are 6.00 except when ZJ7 Rally Wheels are specified.</i>				
TUBELESS. Includes Compact Spare Tire				
<i>P195/75R15 All Seasons Steel Belted Radial Ply Blackwall</i> (Standard)	QAR	NO ADDITIONAL CHARGE		
<i>P195/75R15 All Seasons Steel Belted Radial Ply Whitewall</i>	QAS	N.C.	68.00	68.00
<i>P205/75R15 All Seasons Steel Belted Radial Ply Blackwall</i>	QCE	N.C.	33.00	33.00
<i>P205/75R15 All Seasons Steel Belted Radial Ply Whitewall</i>	QCG	N.C.	105.00	105.00
<i>P205/75R15 All Seasons Steel Belted Radial Ply White Lettered</i>	QCF	N.C.	129.00	129.00
<i>P245/60 HR15 All Seasons Steel Belted Radial Ply White Outline Lettered GT</i> (Maximum Capacity 1593-lbs). Available only when FE3 Sport Suspension is specified.....	QIB	NO ADDITIONAL CHARGE		

OTHER OPTIONS

Air Conditioning: All Weather. Available only when N40 Power Steering is specified. Includes V01 H.D. Radiator when V02 H.D. Radiator and Transmission Oil Cooler is not specified. <i>Front.</i> Instrument panel mounted. Recommended for front seat area cooling only.				
	C60	N.A.	736.00	736.00
<i>Front and Rear.</i> Front instrument panel mounted and rear overhead systems.	C69	N.A.	1320.00	1320.00
Air Dam with Fog Lamps	ANL	N.A.	115.00	115.00
Battery: Heavy-Duty. 12-Volt, 630 Cold Cranking Amps Delco Freedom. Included when V10 Cold Climate Package is specified	UA1	N.A.	56.00	56.00
Bracket, Front License Plate	VK3	NO ADDITIONAL CHARGE		
Bumper Equipment:				
<i>Bumpers, Deluxe Front and Rear.</i> Chromed with color-keyed end caps and black rub strips.				
Without YC6 or YC7	VE5	N.A.	128.00	128.00
With YC6 or YC7	VE5	N.A.	76.00	76.00
<i>Bumpers.</i> Color-Keyed with color-keyed end caps and black rub strips. Standard on YC6 and YC7	VE6	N.A.	52.00	52.00
Cargo Capacity, Increased: Available only when ZP4 or ZP5 Seating Arrangement and P205 or P245 Tires are specified. Includes F59 Stabilizer Bar and N40 Power Steering				
	X6X	N.A.	334.00	334.00
Carrier, Luggage: Black	V54	N.A.	126.00	126.00
Cooling Systems:				
<i>Engine Oil.</i> Included with Z82 Trailering Special. Available only when V01 H.D. Radiator or V02 H.D. Radiator and Transmission Oil Cooler is specified				
	KC4	N.A.	126.00	126.00
<i>Radiator, Heavy-Duty:</i> Included when C60 Front or C69 Front and Rear Air Conditioning is specified without V02 H.D. Radiator and Transmission Cooler				
	V01	N.A.	56.00	56.00
<i>Radiator and Transmission Oil, Heavy-Duty.</i> Included with Z82 Trailering Special. Available only when MX0 Automatic Transmission is specified. Not available when V01 H.D. Radiator is specified				
Without C60 Front or C69 Front and Rear Air Conditioning	V02	N.A.	118.00	118.00
With C60 Front or C69 Front and Rear Air Conditioning	V02	N.A.	63.00	63.00
Cold Climate Package: Includes K05 Engine Block Heater, UA1 H.D. Battery and anti-freeze protection to -32 degrees.				
	V10	N.A.	105.00	105.00

(a) D & H Charges on vehicle and optional equipment include reimbursement to ordering Division for any tax that it has paid, incurred or agreed to pay thereon.
◇ State and local taxes not included.

ASTRO/SAFARI (PASSENGER VAN)

OPTIONS WHEN INSTALLED BY GENERAL MOTORS

prices shown are effective with vehicles produced on and after January 2, 1988

Description	Option Number	Factory D&H(a)	List Price	Mfr's Suggested Retail Price [◇]
OTHER OPTIONS				
Console, Roof: Available only when TR9 Auxiliary Lighting, YC6 or YC7 is specified. Includes dome lamp, map lamps and two stowage compartments	DK6	N.A.	83.00	83.00
Door Lock System, Power: All Doors. Included when ZQ2 Operating Convenience Package is specified	AU3	N.A.	211.00	211.00
Floor Covering: <i>Carpeting, Wheelhousing and Floor. Standard on YC6 and YC7.</i>	B30	N.A.	117.00	117.00
<i>Mats, Color-Keyed. Removable. Available only when B30 Carpeting is specified.</i>				
With ZP4 4 Passenger or ZP5 5 Passenger Seating Arrangement	B37	N.A.	47.00	47.00
With ZP7 7 Passenger or ZP8 8 Passenger Seating Arrangement	B37	N.A.	69.00	69.00
Gages: Voltmeter, Temperature, Oil Pressure and Trip Odometer. Standard on YC6 and YC7. Not available when U52 Electronic Instrumentation is specified	Z53	N.A.	62.00	62.00
Glass Arrangements: Complete Body.	ZW6	N.A.	128.00	128.00
Glass, Tinted: All Windows. Includes A02 Windshield Glass.				
Without ZW6 Complete Body Glass	A01	N.A.	75.00	75.00
With ZW6 Complete Body Glass	A01	N.A.	104.00	104.00
Windshield only. Included when A01 Tinted, AA3 Deep Tinted or AJ1 Deep Tinted Glass is specified	A02	N.A.	40.00	40.00
<i>Deep Tinted. Not available when A01 Tinted Glass is specified. Includes tinted glass on passenger and driver's side door. Also includes A02 Windshield Glass and dark coated glass on side windows and rear door.</i>				
Without ZW6 Complete Body Glass	AJ1	N.A.	236.00	236.00
With ZW6 Complete Body Glass	AJ1	N.A.	365.00	365.00
<i>Deep Tinted with Light Tinted Rear Window. Not available when A01 Tinted or AJ1 Deep Tinted Glass is specified. Includes tinted glass on passenger, driver's side and rear doors. Also includes A02 Tinted Windshield and dark coated glass on side windows.</i>				
Without ZW6 Complete Body Glass	AA3	N.A.	185.00	185.00
With ZW6 Complete Body Glass	AA3	N.A.	308.00	308.00
Glass, Swing-Out: Rear door. Standard on YC7	A18	N.A.	59.00	59.00
Grille, Deluxe: Black with argent highlights	TL1	N.A.	27.00	27.00
Harness, Wiring: Trailer. 5-lead. Not available when Z82 Trailing Special is specified. Included with Z72 Trailing Special	U89	N.A.	41.00	41.00
Headlamps: Halogen.	TT4	N.A.	24.00	24.00
Heaters: <i>Engine Block. 600 Watts, 120 Volts. Included when V10 Cold Climate Package is specified</i>	K05	N.A.	33.00	33.00
<i>Rear. Located on left side, forward of rear fender well</i>	C36	N.A.	267.00	267.00
Instrumentation, Electronic: Available only when MX0 Automatic Transmission is specified				
Without YC6 or YC7. Includes Z53 Gages	U52	N.A.	212.00	212.00
With YC6 or YC7	U52	N.A.	150.00	150.00
Lamp: Dome and Reading. Available only when YC6, YC7 or TR9 Auxiliary Lighting is specified. Not available when DK6 Roof Console is specified	C95	N.A.	33.00	33.00
Lighter, Cigarette: Includes ash tray light. Included with TR9 Auxiliary Lighting.	U37	N.A.	32.00	32.00
Lighting, Auxiliary: Included with YC6 or YC7. Includes U37 Cigarette Lighter, glove box and convenience tray lamps, door jamb switches on all doors, stepwell lamps for front and sliding doors and door jamb defeat switch	TR9	N.A.	128.00	128.00

(a) D & H Charges on vehicle and optional equipment include reimbursement to ordering Division for any tax that it has paid, incurred or agreed to pay thereon.
[◇] State and local taxes not included.

ASTRO/SAFARI (PASSENGER VAN)

OPTIONS WHEN INSTALLED BY GENERAL MOTORS

prices shown are effective with vehicles produced on and after January 2, 1988

Description	Option Number	Factory D&H(a)	List Price	Mfr's Suggested Retail Price◇
OTHER OPTIONS				
Mirrors:				
<i>Deluxe LH and RH. Below Eye-Line. Painted. Black</i>	D44	N.A.	52.00	52.00
<i>Electric, Remote</i>	D48	N.A.	150.00	150.00
<i>Visor, Vanity, Illuminated. RH. Available only when Custom Cloth or Custom Vinyl Trim is specified.</i>	D64	N.A.	43.00	43.00
Moldings:				
<i>Body Side, Black. Standard on YC6 and YC7. Not available when B88 Moldings are specified</i>	B84	N.A.	59.00	59.00
<i>Wheel Opening, Black. Standard on YC6 and YC7. Not available when B88 Moldings are specified</i>	B96	N.A.	31.00	31.00
<i>Guards, Door Edge. Black</i>	B93	N.A.	18.00	18.00
Operating Convenience Package: Includes AU3 Power Door Locks and A31 Power Windows	ZQ2	N.A.	411.00	411.00
Preliminary Price Information	B3W	N.A.	N.A.	N.A.
Radio Equipment:				
<i>AM Radio. Includes dual front speakers</i>	U63	N.A.	122.00	122.00
<i>AM/FM Radio. Includes dual front speakers</i>	U69	N.A.	181.00	181.00
<i>AM/FM Stereo Radio. Electronically Tuned. Includes dual front and rear speakers.</i>	UU9	N.A.	293.00	293.00
<i>AM/FM Stereo Radio with Seek and Scan and Digital Clock. Electronically Tuned. Includes dual front and rear speakers.</i>	UM7	N.A.	347.00	347.00
<i>AM/FM Stereo Radio with Seek and Scan, Stereo Cassette Tape and Digital Clock. Electronically Tuned. Includes dual front and rear speakers</i>	UM6	N.A.	474.00	474.00
<i>AM Stereo and FM Stereo Radio with Seek and Scan, Stereo Cassette Tape with Search and Repeat, Graphic Equalizer and Digital Clock. Electronically Tuned. Includes dual front and rear speakers</i>	UX1	N.A.	624.00	624.00
Seating Arrangements: One of the following seat options must be specified.				
Four Passenger Seating. Includes Four Bucket Seats, 2-Front and 2-Midship. Includes seat adjuster, seat belts and A78 Seat Back Recliner and Dual Armrests on all seats. Deletes standard center seat. Not available when standard vinyl trim is specified.				
Without YC6 or YC7	ZP4	N.A.	670.00	670.00
With YC6	ZP4	N.A.	583.00	583.00
With YC7	ZP4	NO ADDITIONAL CHARGE		
Five Passenger Seating. Standard. Includes two front bucket seats and seat belts. Without YC7, also includes R.H. Armrest and fold-down feature on bench seat. With YC7, also includes fold-down center console with convenience tray and reclining seat backs				
	ZP5	NO ADDITIONAL CHARGE		
Seven Passenger Seating. Includes ZP4 Four Bucket Seats, A78 Seat Back Recliner and Dual Armrests, seat belts, three passenger rear bench seat and armrests mounted on rear wheelhousings, N40 Steering and F59 Front Stabilizer. Without YC7, also includes fold-down feature on rear seat. With YC7, also includes fold-down center console with convenience tray and reclining seat backs. Available only when P205 or P245 Tires are specified.				
Without YC6 or YC7	ZP7	N.A.	1351.00	1351.00
With YC6	ZP7	N.A.	1263.00	1263.00
With YC7	ZP7	N.A.	1160.00	1160.00
Eight Passenger Seating. Includes ZP5 5-passenger seating, three passenger rear seat, N40 Power Steering and F59 Front Stabilizer. Also includes seat belts and R.H. armrest on center seat. Rear seat includes seat belts and armrests mounted on rear wheelhousings. Without YC7, also includes fold-down feature on center and rear seats. With YC7 also includes fold-down center console with convenience tray and reclining seat backs. Available only when P205 or P245 Tires are specified.				
Without YC6 or YC7	ZP8	N.A.	626.00	626.00
With YC6	ZP8	N.A.	678.00	678.00
With YC7	ZP8	N.A.	1160.00	1160.00

(a) D & H Charges on vehicle and optional equipment include reimbursement to ordering Division for any tax that it has paid, incurred or agreed to pay thereon.
 ◇ State and local taxes not included.

ASTRO/SAFARI (PASSENGER VAN)

OPTIONS WHEN INSTALLED BY GENERAL MOTORS

prices shown are effective with vehicles produced on and after January 2, 1988

Description	Option Number	Factory D&H(a)	List Price	Mfr's Suggested Retail Price◇
OTHER OPTIONS				
Seat Back Recliner and Dual Armrests: For high back driver and front passenger seats only. Available only when Custom Trim is specified. Included when YC7, ZP4 or ZP7 Seating Arrangement is specified.				
	A78	N.A.	241.00	241.00
Seat, Power: Driver's side only. Electric. Six-Way Control.				
	AC3	N.A.	240.00	240.00
Shock Absorbers: Heavy Duty. Front and Rear				
	F51	N.A.	36.00	36.00
Speed Control, Electronic				
	K34	N.A.	205.00	205.00
Stabilizer Bar: Front. Included with X6X Increased Cargo Capacity, ZP7 or ZP8 Seating Arrangement				
	F59	N.A.	40.00	40.00
Steering:				
Power. Available only when F59 Front Stabilizer Bar is specified. Included with X6X Increased Cargo Capacity, ZP7 or ZP8 Seating Arrangement.				
	N40	N.A.	292.00	292.00
Power, Not Desired				
	N51	NO ADDITIONAL CHARGE		
Steering Wheels:				
Comfortilt				
	N33	N.A.	121.00	121.00
Custom. Standard on YC6				
	N31	N.A.	28.00	28.00
Sport. Standard on YC7				
Without YC6				
	NK3	N.A.	35.00	35.00
With YC6				
	NK3	N.A.	7.00	7.00
Striping, Body: Not available when ZY7 Sport Two-Tone Paint or YC7 is specified. With ZY1 Solid Paint, available only when the following stripe color is specified. Included with ZY3 Special Two-Tone Paint				
	D85	N.A.	79.00	79.00
Stripe Color: Available only when ZY1 Solid Paint and D85 Striping are specified. (Refer Color and Trim Chart for option availability)				
Blue with Silver Border				
	25A	NO ADDITIONAL CHARGE		
Gold with Black Border				
	53A	NO ADDITIONAL CHARGE		
Orange with Black Border				
	58A	NO ADDITIONAL CHARGE		
Red with Black Border				
	74A	NO ADDITIONAL CHARGE		
Red with Silver Border				
	71A	NO ADDITIONAL CHARGE		
Suspension, Sport: With ZP4 or ZP5 Seating arrangement available only when X6X Increased Cargo Capacity is specified. Includes gas loaded shock absorbers, rear stabilizer bar and P245/60HR15 GT white outline lettered tires				
Without YC6 or YC7. Includes ZJ7 Rally Wheels				
	FE3	N.A.	542.00	542.00
With YC6. Includes ZJ7 Rally Wheels				
	FE3	N.A.	500.00	500.00
With YC7				
	FE3	N.A.	450.00	450.00
Tank, Fuel: Approximately 27-gallon capacity. Replaces production fuel tank				
	NL9	N.A.	70.00	70.00
Tie-Downs, Cargo: Available only when ZP4 or ZP5 Seating Arrangement and X6X Increased Cargo Capacity are specified				
	AP1	N.A.	32.00	32.00
Tires, Puncture Sealant: Available only when QCG P205 Tires are specified				
	P42	N.A.	184.00	184.00
Trailer Hitch: Deadweight Type. Not available when Z82 Trailing Special is specified. Included with Z72 Trailing Special				
	VR2	N.A.	68.00	68.00

(a) D & H Charges on vehicle and optional equipment include reimbursement to ordering Division for any tax that it has paid, incurred or agreed to pay thereon.
 ◇ State and local taxes not included.

ASTRO/SAFARI (PASSENGER VAN)

OPTIONS WHEN INSTALLED BY GENERAL MOTORS

prices shown are effective with vehicles produced on and after January 2, 1988

Description	Option Number	Factory D&H(a)	List Price	Mfr's Suggested Retail Price◇
OTHER OPTIONS				
Trailing Special Equipment: (See Trailing Guide for GCW Ratings with available power team combinations.)				
<i>Heavy-Duty.</i> Includes Weight Distributing Hitch Platform, H.D. flashers, H.D. 7 Lead Wiring Harness, KC4 Engine Oil Cooler and V02 H.D. Radiator and Transmission Oil Cooler. Available only when N40 Power Steering, UA1 H.D. Battery, F51 H.D. Shock Absorbers, F59 Stabilizer, MX0 Automatic Transmission and 3.42 or 3.73 Rear Axle Ratio are specified.				
Without C60 Front or C69 Front and Rear Air Conditioning	Z82	N.A.	555.00	555.00
With C60 Front or C69 Front and Rear Air Conditioning	Z82	N.A.	498.00	498.00
<i>Light-Duty.</i> Includes VR2 Deadweight Trailer Hitch, H.D. flashers and U89 5 Lead Wiring Harness. Available only when MX0 Transmission and V01 H.D. Radiator or V02 H.D. Radiator and Transmission Oil Cooler and 3.23 or 3.42 Rear Axle Ratio are specified.				
	Z72	N.A.	109.00	109.00
Wheel Trim:				
<i>Wheel Covers, Bright Metal.</i> Includes black wheel. Standard on YC6. Not available when YC7 is specified				
	P01	N.A.	42.00	42.00
<i>Trim Rings.</i> Includes black wheel. Included with ZJ7 Rally Wheels. Not available when YC6 or YC7 is specified				
	P06	N.A.	60.00	60.00
Wheels:				
<i>Rally, 6.5" Argent.</i> Included with FE3 Sport Suspension. Includes special hub caps and P06 Trim Rings. Standard on YC7				
Without YC6	ZJ7	N.A.	92.00	92.00
With YC6	ZJ7	N.A.	50.00	50.00
<i>Aluminum, Cast.</i> Four wheels only. Includes 15" x 6.5" wheels and special hub caps.				
Without YC6 or YC7 or FE3 Sport Suspension	PF3	N.A.	316.00	316.00
With YC6	PF3	N.A.	274.00	274.00
With YC7. Wheels are Color-Coordinated	PF3	N.A.	224.00	224.00
With FE3 Sport Suspension	PF3	N.A.	224.00	224.00
Windows: Power. Front side doors only. Included when ZQ2 Operating Convenience Package is specified				
	A31	N.A.	200.00	200.00
Windshield Wiper System: Intermittent				
	CD4	N.A.	59.00	59.00

(a) D & H Charges on vehicle and optional equipment include reimbursement to ordering Division for any tax that it has paid, incurred or agreed to pay thereon.
 ◇ State and local taxes not included.

ASTRO/SAFARI SL

**CAB & BODY FEATURES
SEATING ARRANGEMENTS
COLOR & TRIM CHARTS
TWO-TONES**

ASTRO/SAFARI SL

(Passenger Van)

ASTRO CS/SAFARI SLX STANDARD MODEL—BODY ORDERING CODE—ZW9

The standard model includes the following items as standard equipment

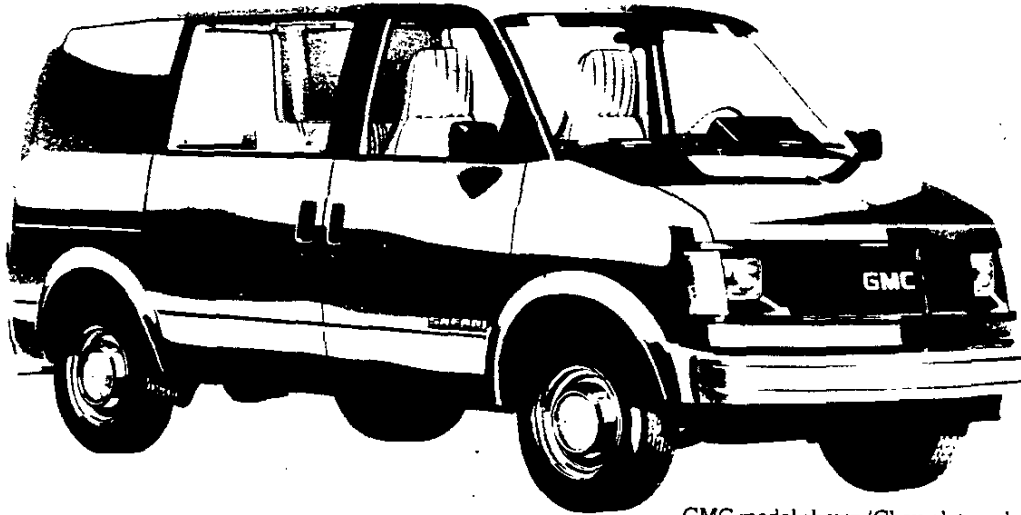

GMC model shown (Chevrolet model available)

EXTERIOR

- **Bumpers:** Front and rear, painted lower body color
- **Black Painted Window Pillars**
- **Colors:** See Interior and Exterior Color Selection Chart
- **Doors:** RH and LH front side doors; RH and LH rear load doors; and a RH sliding side load door
- **Door Opening and Locking Methods:**
 - Front side doors: Outside flush pull-out type door handle with separate key lock
 - Sliding side load door: Outside flush pull-out type handle releases both front and rear latches; for opening and closing of door from inside, reverse outside procedure
 - RH and LH rear doors: Flush pull-out type RH door handle opens door, and after opening RH door, LH door latch is released by inside handle; key lock cylinder in RH door
- **Glass:** Windshield; RH and LH front side door drop glass; side swing-out sliding door glass; RH and LH rear door glass; and LH front swing-out quarter glass
- **Grille:** Molded plastic; painted black; bright Chevrolet emblem/GMC letters at center
- **Headlamps/Parking Lamps:** Headlamp/parking lamp bezels painted black
- **Horn:** Dual, electric high- and low-note
- **Hub Caps:** Bright metal with black trim
- **Keys:** Two-key system with separate keys for ignition switch and doors
- **Lights:**
 - Backup lamps: Two rear (integral with taillamps)
 - Combination parking/direction/hazard: Two front
 - Combination tail/stop/direction/hazard: Two rear
 - Headlamps: Two; Rectangular
 - License plate lamp: Single rear
 - Side marker lamps with reflectors: Integral with front parking lamps and rear taillamps
- **Mirrors:** RH and LH painted black; pivoting arm with adjustable 34.1 sq. in. head
- **Nameplates:** Bright "Astro/Safari" plate on front doors; "Chevrolet/GMC" letters plate on RH rear door in license plate housing; "FUEL INJECTION" nameplate on RH rear door
- **Tools:** Screw operated scissor-type jack with ratchet handle, extension and two wheel blocks
- **Undercoating:** Hot melt wax on entire underbody
- **Wheels:** Painted argent
- **Windshield Wipers and Washers:** Electric, 2-speed wipers with black finish on exposed metal portions; wet-arm design demand-type washer system

ASTRO/SAFARI SL

(Passenger Van)

ASTRO CS/SAFARI SLX MODEL—BODY ORDERING CODE YC5

This option includes all exterior items listed for the standard model plus the following additions or substitutions

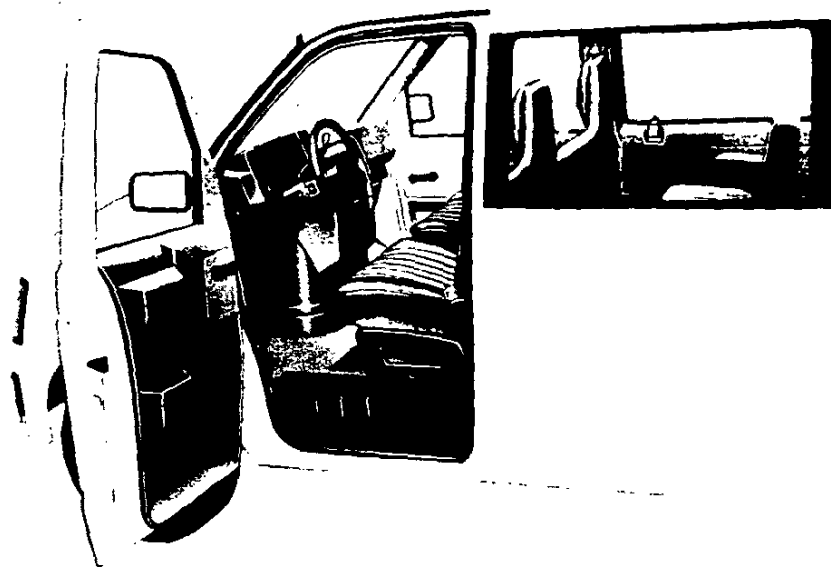

INTERIOR

- **Air Vents:** Integral with heater
- **Armrests:** LH and RH
- **Ashtray:** At center in engine cover console
- **Coat Hooks:** Two LH and one RH side, on roof rails
- **Colors:**
 - Painted areas: Same as exterior primary color choice
 - Interior trim: Coordinated with seat trim color choice
- **Dome Lamps:** Two; with front door-actuated switches (dome lamps may also be activated by main light switch)
- **Door Locks:** Inside lock/release for front doors and sliding side door
- **Door Seals:** Latex foam rubber
- **Floor Covering:** Embossed color-keyed rubber mats on entire floor area including front and rear wheelhousings
- **Fuel Filler Door:** With remote release
- **Garnish Moldings:** Color-keyed plastic moldings for rear compartment side windows, front and rear roof header panels, roof front side rails and windshield pillars, front door lock pillars, lower sliding door hinge pillar, and sliding door track and roller bracket
- **Headliner:** Full-length, color-keyed; foam-backed cloth
- **Heater and Defogger:** Deluxe air with side window defogger
- **Hood Lock Release:** Handle located on RH side of instrument panel
- **Instruments:**
 - Gages: Speedometer, odometer, and fuel
 - Switches: Main, for control of exterior lights, instrument lights and dome lights; multi-function switch on steering column for direction signals by moving lever up or down (includes lane change position), headlight beams by pulling lever toward driver, windshield wiper by turning band marked "WIPER" toward or away from driver, and windshield washer by pushing in the lever knob; ignition with key-in warning buzzer; hazard warning; heater fan; door-operated dome lamp
 - Warning lights: Generator, oil pressure, engine temperature, service-parking brake, direction/hazard signal, and high beam
- **Instrument Panel:** Molded gray plastic faceplate, with bright "Astro CS/Safari SLX" lettering and trim
- **Insulation and Sound Deadening Material:** Dash (firewall), front floor panel, engine cover front extension and inside engine cover, above headliner and on wheelhousing areas
- **Jack and Tool Cover:** Molded, color-keyed plastic in RH rear quarter area
- **Lights:** Instruments, front and rear dome
- **Positive Rear Door Steps**
- **Seat:** Front high back bucket driver and front passenger; adjustable; all-vinyl trim; foam padded plus center removable 3-passenger bench seat. Also available at extra cost: High back center bucket seats and rear 3-passenger bench seat in standard vinyl, Custom vinyl or Custom Cloth. See Interior and Exterior Color Selection Chart for color and trim availability
- **Seat Belts:** Color-keyed with pushbutton release for all seating positions
- **Sill Plates and Stepwell Mats:** Black plastic, on all door openings
- **Spare Tire Carrier:** Under floor
- **Steering Wheel and Column:** 15.24" diameter black vinyl wheel; black energy-absorbing steering column with anti-theft locking feature
- **Storage Compartment:** Molded, color-keyed plastic in LH rear quarter area
- **Stowage Box:** In front face of engine cover extension; with latched door; includes beverage holder provisions
- **Sunshade:** LH and RH, color-keyed cloth; with RH visor vanity mirror
- **Trim Panels:** Colored-keyed vinyl on doors and sidewalls with map pockets on front doors

ASTRO/SAFARI SL

(Passenger Van)

ASTRO CL/SAFARI SLE MODEL—BODY ORDERING CODE YC6

This model includes all items listed for Astro CS/Safari SLX model option plus the following additions or substitutions

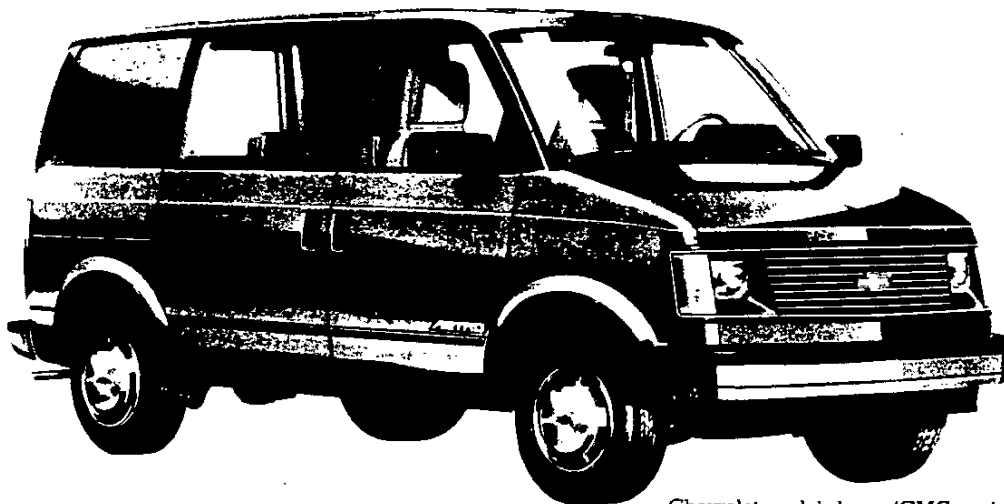

Chevrolet model shown (GMC model available)

EXTERIOR

- **Bumpers:** With color-keyed end caps and black combination top step surface (rear only) and rub strip
- **Grille:** Chevrolet—Black with argent paint on feature surfaces with bright applied Chevrolet emblem
GMC—Black with argent paint on feature surfaces and bright applied GMC letters with red paint fill
- **Moldings:** Black body side and wheel opening
- **Wheel Covers:** Bright

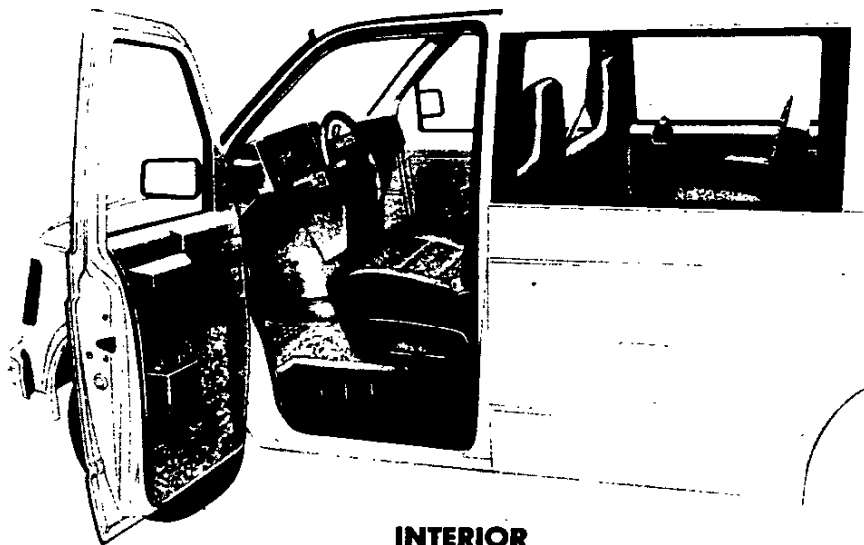

INTERIOR

- **Bright Appearance Items:**
"Astro CL/Safari SLE" lettering and trim on instrument panel
- **Cigarette Lighter:** With ashtray light
- **Floor Covering:** Color-keyed carpeting over entire floor area including front and rear wheelhousings; lower portion of engine cover and vertical walls of front and rear side door stepwells
- **Headlamp Warning Chimes**
- **Instrument Cluster:** Voltmeter, oil pressure gage and engine temperature gage replace warning lamps; also includes trip odometer
- **Kick Panels:** Color-keyed with carpet inserts
- **Lights:** Stowage box and convenience tray, step-well lamps
- **Seats:** High-backed driver and front passenger bucket seats, and standard rear passenger seat with choice of: 1) Custom vinyl trim; or 2) Custom cloth/vinyl trim. See Interior and Exterior Color Selection Chart for color and trim availability.
- **Steering Wheel:** Custom
- **Switches:** Dome lamp doorjamb switches for sliding side and rear doors; also includes doorjamb defeat switch
- **Trim:** Color-keyed window latches, engine cover latches, scuff and sill plates and seat pocket trim
- **Trim Panels:** Color-keyed expanded vinyl with carpet inserts and insulation

ASTRO/SAFARI SL

(Passenger Van)

ASTRO LT/SAFARI TOURING MODEL — BODY ORDERING CODE YC7

This model includes all items listed for Astro CL/Safari SLE model option plus the following additions or substitutions



EXTERIOR

- **Glass:** Swing-out rear door glass.
- **Nameplates:** Special nameplates on front side door "B" pillars.
- **Special Paint:** Choice of two special paint colors: Midnight Blue Metallic or Caramel Brown Metallic.
- **Striping:** Wide, color-keyed, graduated-tone stripe at beltline.
- **Wheels:** Rally Wheels are Argent with Midnight Blue; Metallic Gold with Caramel Brown.

INTERIOR

- **Ash Tray:** On LH side of center seat.
- **Color-Keyed Components:** Seat pocket trim; scuff plate and sill plates; window and engine cover latches; and, when radio is ordered, rear speaker grilles.
- **Interior Trim:** Padded, covered with special velour fabric to match seats.
- **Nameplates:** On glove box door.
- **Seats:** Special front bucket seats with reclining backs, folding integral armrests and full-width adjustable headrests. Split-back center bench seat includes fold-down center console with convenience tray and cup pockets. When in the upright position, the console forms a seat-back for the center seating position. Outboard positions have adjustable headrest. All seats are trimmed with special velour fabric. RH seat-back of center bench seat also folds forward for easy access to rear of vehicle.
- **Steering Wheel:** Special luxury sport type.
- **Storage Pouch:** On LH side trim panel, next to center seat; with zipper.

NOTES

ASTRO/SAFARI SL

(PASSENGER VAN)

BODY CONSTRUCTION FEATURES

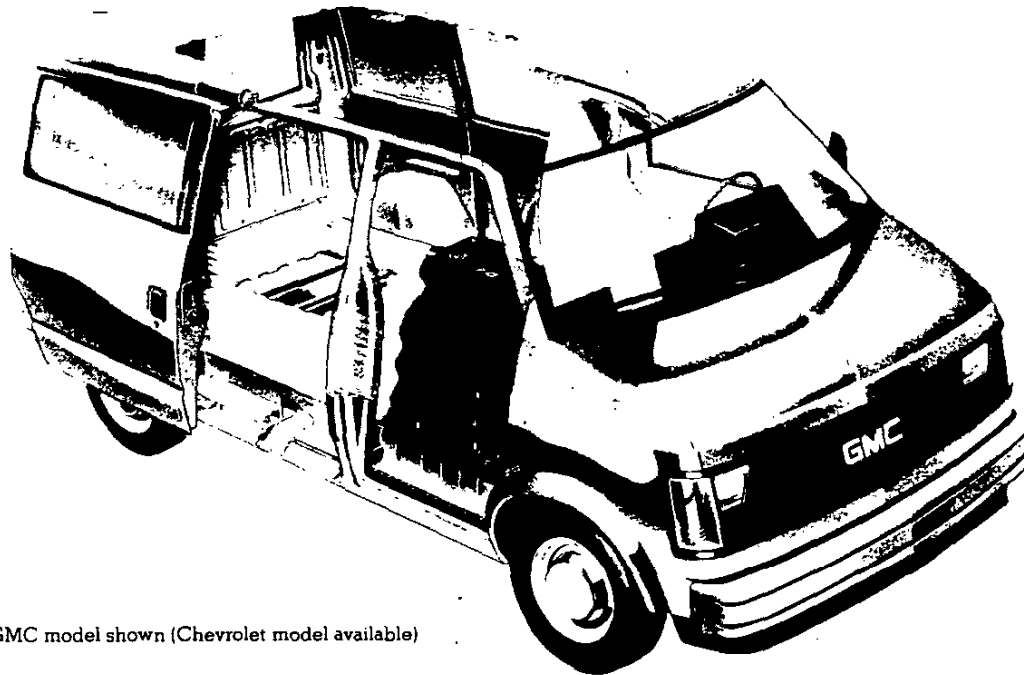

GMC model shown (Chevrolet model available)

BODY CONSTRUCTION FEATURES

- Computer-aided design.
- All-steel construction (except cowl panel).
- Body-frame integral construction for outstanding structural rigidity and excellent durability.
- Comprised of underbody structure, front end structure, left- and right-hand side panel structures and a roof panel structure.
- Longitudinal side rails, cross sills and outriggers form the integral frame to which front and rear floor panels are welded, completing the underbody structure. Main structural members are of heavy-gage steel. A step well is incorporated in the underbody in the area adjacent to the front doors and sliding side door to provide convenient entry and exit.
- Floor panel provides for available underfloor spare tire carrier.

FRONT END STRUCTURE

- Engine compartment with inside opening hood panel allows quick access to service points such as engine, radiator, brake system, battery and windshield washer reservoir.
- The radiator support upper tie bar is mechanically attached to facilitate engine removal.
- A plenum chamber with high-level air intake is utilized in the front end structure to assure a plentiful supply of dry, outside air for interior heating and ventilating as well as to add rigidity to the overall body structure. Air outlets to the interior are provided on the left-hand and right-hand sides by manually controlled doors (RH door omitted with optional air conditioning).
- Bolt-on front fenders for ease of serviceability.

SIDE PANEL STRUCTURES

- Seamless, one-piece outer panels reinforced with one-piece inner panel construction.
- Roof is welded to side panels.
- Inner side panels are welded to floor panel at bottom, leaving no exterior exposed welds.
- Many window configurations available.
- Front quarter and side door glass available on cargo model, standard on passenger van model.
- Optional rear quarter glass is fixed.
- All window openings are of one-piece stamped construction for excellent fit and corrosion resistance.
- Provision is made at the center of LH side panel for fuel filler door. Inside remote operation of door is available as an option.
- RH side panel incorporates center track for sliding door, providing low operating effort.
- Flush-mounted side glass.

ROOF PANELS

- One-piece design.
- Four longitudinal stiffening ribs.
- Welded to side panels.
- Eliminates exposed drip gutters.
- Center rear surface of panel is free of stiffening ribs to allow roof vent installation.
- Four roof bows support the roof panel.

ADDITIONAL BODY FEATURES

- Completely automated assembly features extensive use of automatic and robotic equipment to weld and assemble body.
- All body openings, front door frames, window frames, windshield frame, rear door frame and side door frame are of one-piece construction for precise fits and excellent corrosion resistance.
- Concealed front door hinges.
- Concealed hood hinges.
- Flush-mounted glass (except front doors).
- Improved body seals (weatherstrips) body mounted at front and side doors.
- On-line water test to eliminate leaks.

Special attention is given to corrosion prevention during the construction and final finishing of the body. The following body design features occur during the construction of the body:

- Use of special steel (galvanized, zinc iron alloy, zinc coated) for body components especially subject to corrosion.
 - All exterior body panels (except roof) are two-side galvanized.
 - Use of one-piece outer panels, eliminating exterior joints where corrosion might occur.
 - Use of heavy-gage steel for main underbody components.
 - One-piece opening frame construction eliminates lap joints and other potential corrosion areas.
 - No exposed welds.
- After body construction is completed, additional corrosion prevention steps are taken in the final finishing operation.
- The body, doors and hood are thoroughly cleaned through a 7-stage phosphate wash (4 immersion stages, 3 wash stages).
 - Next, body, doors and hood are primed by the uni-prime process.
 - Sealers are applied to all critical interior/exterior joints.
 - The body, doors and hood are painted with base coat/clear coat enamel.
 - An anti-chip coating along the lower body sides is added which extends from the rear of the front wheel openings to the rear door openings to prevent stone chipping.
 - Hot-wax spray is applied to entire underbody for sound deadening and corrosion resistance.

ASTRO/SAFARI

(Passenger Van)

DIMENSIONS*

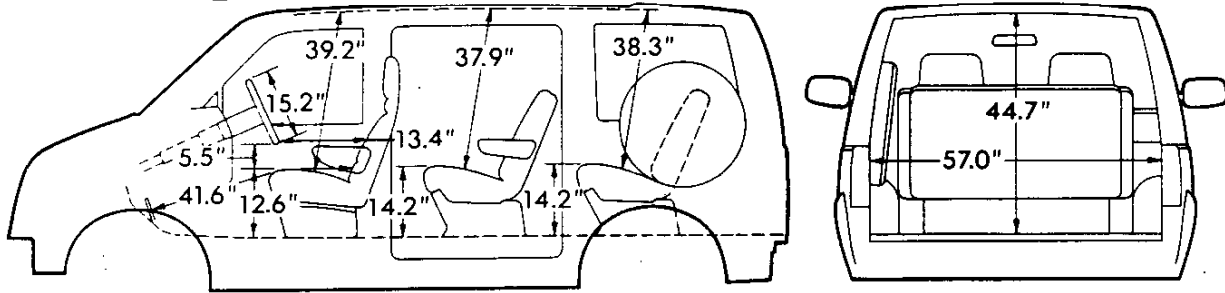

Glass Area (sq in)

Windshield	1858	Rear side windows (each side)	883.5
Front side door window (each side)	532	Rear door windows (total) .	960

*All interior dimensions measured with front seat in rearmost position. Seat travel is 5"

INSTRUMENT CLUSTER

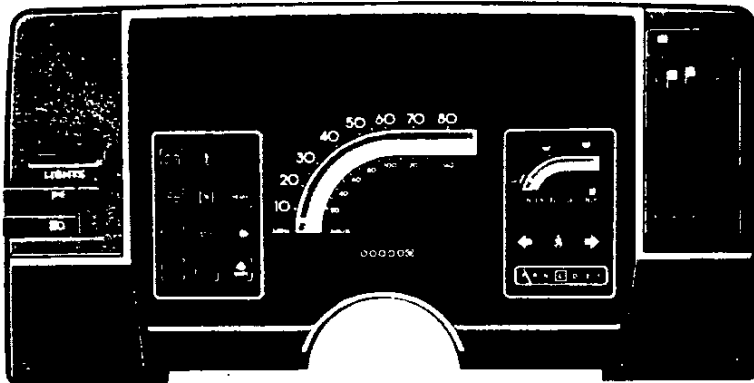

Standard Cluster with warning lights for engine temperature, generator, and oil pressure.

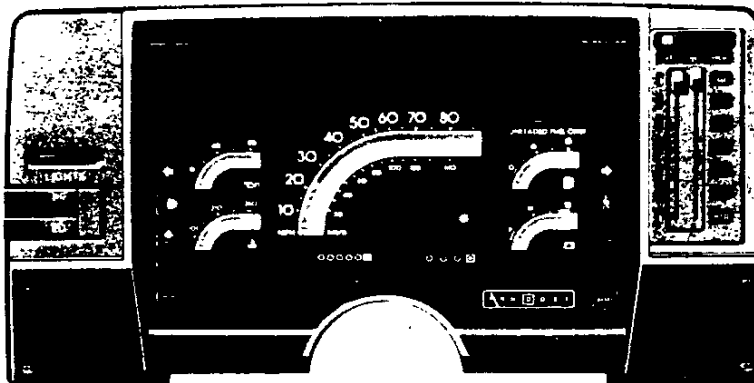

Optional Cluster (RPO 253) with volt-meter, engine temperature gage, oil pressure gage and trip odometer. Included when Astro CL/Safari SLE or Astro LT/Safari SLT is ordered. Cluster faceplate for standard models has argent finish. When the optional gage cluster is ordered on standard or Astro CL/Safari SLX models, it replaces the respective warning lights and the remaining warning lights are moved to either side as illustrated.

ASTRO/SAFARI

(Passenger Van)

INTERIOR AND EXTERIOR COLOR AVAILABILITY CHART WITHOUT YC7 LUXURY TOURING/GMC TOURING PACKAGE

Please Note: Below are the interior trim color and exterior paint combinations recommended by Chevrolet/GMC. The only available color code 1/color code 2 exterior color combinations are those shown in the chart below; however, any available interior trim color may be ordered with one of these exterior color combinations if that particular combination is desired by the customer.

TRIM LEVEL Seat Type	Decor	INTERIOR COLORS				Color Code 1	Color Code 2	RECOMMENDED INTERIOR TRIM COLORS					Blue/Silver 25A	Gold/Black 63A	Orange/Black 58A	Red/Black 74A	Red/Silver 71A
		Teal Blue	Burgundy	Saddle	Slate Gray			Blue/Silver 25A	Gold/Black 63A	Orange/Black 58A	Red/Black 74A	Red/Silver 71A					
STANDARD INTERIOR ASTRO CS/SAFARI SLX Vinyl High Back Bucket Seats Custom Vinyl High Back Bucket Seats Custom Cloth High Back Bucket Seats	Std.	VDD4	XEE4	VSS4													
		XDD4	XEE4	XSS4	XTT4												
		KDD4	KEE4	KSS4	KTT4												
ASTRO CL/SAFARI SLE Custom Vinyl High Back Bucket Seats Custom Cloth High Back Bucket Seats	YC6	XDD4	XEE4	XSS4	XTT4												
		KDD4	KEE4	KSS4	KTT4												
ZY1 PAINT OPTIONAL STRIPING CHART RECOMMENDED COMBINATIONS (Requires D85 Body Striping) Additional stripe combinations are available provided the dealer orders (D60) as verification.																	
EXTERIOR COLORS w/ZY1 PAINT		Color Code 1	Color Code 2	RECOMMENDED INTERIOR TRIM COLORS					Blue/Silver 25A	Gold/Black 63A	Orange/Black 58A	Red/Black 74A	Red/Silver 71A				
BLACK, ONYX	20	20	•	•	•	•	•	•	•	•	•	•	•	•	•	•	
BLUE, ICED (Metallic)	22	22	•	•	•	•	•	•	•	•	•	•	•	•	•	•	
GOLD, SUNSET (Metallic)	34	34	•	•	•	•	•	•	•	•	•	•	•	•	•	•	
GRAY (Metallic)	83	83	•	•	•	•	•	•	•	•	•	•	•	•	•	•	
RED, BURNT (Metallic)	77	77	•	•	•	•	•	•	•	•	•	•	•	•	•	•	
RED, DEEP (Metallic)	75	75	•	•	•	•	•	•	•	•	•	•	•	•	•	•	
SILVER, STERLING (Metallic)	15	15	•	•	•	•	•	•	•	•	•	•	•	•	•	•	
TAN	60	60	•	•	•	•	•	•	•	•	•	•	•	•	•	•	
WHITE, IVORY	10	10	•	•	•	•	•	•	•	•	•	•	•	•	•	•	
WHITE, IVORY	10	10	•	•	•	•	•	•	•	•	•	•	•	•	•	•	
WHITE, IVORY	10	10	•	•	•	•	•	•	•	•	•	•	•	•	•	•	
WINTERGREEN (Metallic)	36	36	•	•	•	•	•	•	•	•	•	•	•	•	•	•	
w/ZY3 or ZY7 PAINT																	
*STRIPE COLORS (Stripe Colors cannot be changed)																	
BLACK, ONYX/Gold, Sunset (Met.)	20	34	•	•	•	•	•	•	•	•	•	•	•	•	•	•	
BLACK, ONYX/Red, Burnt (Met.)	20	77	•	•	•	•	•	•	•	•	•	•	•	•	•	•	
BLACK, ONYX/Silver, Sterling (Met.)	20	15	•	•	•	•	•	•	•	•	•	•	•	•	•	•	
BLACK, ONYX/Tan	20	60	•	•	•	•	•	•	•	•	•	•	•	•	•	•	
BLUE, ICED (Met.)/Silver, Sterling (Met.)	22	15	•	•	•	•	•	•	•	•	•	•	•	•	•	•	
GOLD, SUNSET (Met.)/Tan	34	60	•	•	•	•	•	•	•	•	•	•	•	•	•	•	
GRAY (Met.)/Silver, Sterling (Met.)	83	15	•	•	•	•	•	•	•	•	•	•	•	•	•	•	
RED, BURNT (Met.)/Gold, Sunset (Met.)	77	34	•	•	•	•	•	•	•	•	•	•	•	•	•	•	
RED, BURNT (Met.)/Silver, Sterling (Met.)	77	15	•	•	•	•	•	•	•	•	•	•	•	•	•	•	
RED, BURNT (Met.)/Tan	77	60	•	•	•	•	•	•	•	•	•	•	•	•	•	•	
RED, DEEP (Met.)/Red, Burnt (Met.)	75	77	•	•	•	•	•	•	•	•	•	•	•	•	•	•	
RED, DEEP (Met.)/Silver, Sterling (Met.)	75	15	•	•	•	•	•	•	•	•	•	•	•	•	•	•	
RED, DEEP (Met.)/Tan	75	60	•	•	•	•	•	•	•	•	•	•	•	•	•	•	
SILVER, STERLING (Met.)/Red, Burnt (Met.)	15	77	•	•	•	•	•	•	•	•	•	•	•	•	•	•	
TAN/Gold, Sunset (Met.)	60	34	•	•	•	•	•	•	•	•	•	•	•	•	•	•	
TAN/Red, Burnt (Met.)	60	77	•	•	•	•	•	•	•	•	•	•	•	•	•	•	
WHITE, IVORY/Red, Burnt (Met.)	10	77	•	•	•	•	•	•	•	•	•	•	•	•	•	•	
WHITE, IVORY/Silver, Sterling (Met.)	10	15	•	•	•	•	•	•	•	•	•	•	•	•	•	•	
WHITE, IVORY/Gold, Sunset (Met.)	10	34	•	•	•	•	•	•	•	•	•	•	•	•	•	•	
WHITE, IVORY/Tan	10	60	•	•	•	•	•	•	•	•	•	•	•	•	•	•	
WINTERGREEN (Met.)/Gold, Sunset (Met.)	36	34	•	•	•	•	•	•	•	•	•	•	•	•	•	•	
WINTERGREEN (Met.)/Silver, Sterling (Met.)	36	15	•	•	•	•	•	•	•	•	•	•	•	•	•	•	
WINTERGREEN (Met.)/Tan	36	60	•	•	•	•	•	•	•	•	•	•	•	•	•	•	

*D85 required if stripe is desired w/ZY7 Paint. Stripe is included w/ZY3 Paint.

INTERIOR AND EXTERIOR COLOR AVAILABILITY CHART WITH YC7 LUXURY TOURING/GMC TOURING PACKAGE

Please Note: Below are the interior trim color and exterior paint combinations recommended by Chevrolet/GMC. They are the only available interior and exterior combinations allowed.

TRIM LEVEL Seat Type	Decor	INTERIOR COLORS		Color Code 1	Color Code 2	RECOMMENDED INTERIOR TRIM COLORS		Blue	Gold
		Teal Blue	Saddle			Blue	Gold		
ASTRO LT/SAFARI SLT Velour Cloth Reclining Bucket Seats	YC7	LDD6	LSS6						
EXTERIOR COLORS w/ZY1 PAINT									
BLUE, MIDNIGHT (Metallic)				98	98	•	•	•	•
BROWN, CARAMEL (Metallic)				68	68	•	•	•	•
w/ZY3 PAINT									
BLUE, ICED (Metallic)/Blue, Midnight (Metallic)				22	98	•	•	•	•
GOLD, SUNSET (Metallic)/Brown, Caramel (Metallic)				34	68	•	•	•	•

ASTRO (Passenger Van)

AVAILABLE WINDOW ARRANGEMENTS

(See Option Section For Restrictions)

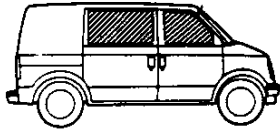
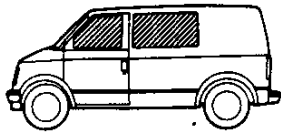

STANDARD
(Includes rear door windows, side sliding door window and LH front quarter window)

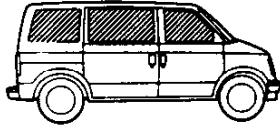
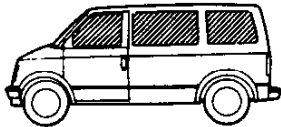

W/ZW6
(Includes RH and LH rear quarter windows)

AVAILABLE SEATING ARRANGEMENTS

(One Seating Arrangement Option Must Be Specified)
(See Option Section For Restrictions)

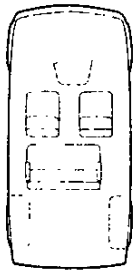

Standard

W/ZP5
Standard 5 person seating without YC7
Includes High Back buckets (2 front) and standard 3-passenger bench seat.

With YC7
Includes reclining bucket seats (2 front) and split back reclining 3-passenger bench seat with folding arm rests.

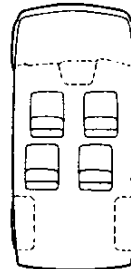

W/ZP4
4 person seating without YC7
Includes 4 High Back buckets (2 front and 2 mid-ship). Not available with standard vinyl trim. Also includes A78 reclining seat backs.

With YC7
Includes reclining bucket seats (2 front and 2 mid-ship).

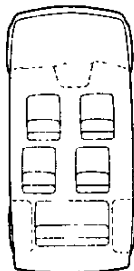

W/ZP7
7 person seating without YC7
Includes 4 High Back buckets and a 3-passenger bench seat. Requires Custom seat trim and P205 tires. Also includes A78 reclining seat backs on bucket seats, N40 Power Steering and F59 Front Stabilizer Bar.

With YC7
Includes 4 reclining bucket seats (2 front and 2 mid-ship) and a split back reclining 3-passenger bench seat with folding armrests. Requires P205 tires. Also includes N40 Power Steering and F59 Front Stabilizer Bar.

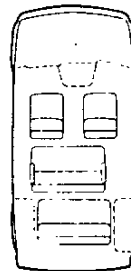

W/ZP8
8 person seating without YC7
Includes 2 High Back buckets and 2 3-passenger bench seats. Requires P205 tires. Also includes N40 Power Steering and F59 Front Stabilizer Bar.

With YC7
Includes 2 reclining bucket seats and 2 split back reclining 3-passenger bench seats with folding armrests. Requires P205 tires. Also includes N40 Power Steering and F59 Front Stabilizer Bar.

ASTRO/SAFARI SL (Passenger Van)

SOLID AND TWO-TONE* EXTERIOR COLOR COMBINATIONS

— The application of paint for solid and two-tone exterior color combinations is shown below.

SOLID COLOR

Solid paint (ZY1) is standard on all models. All painted areas of the body and front end sheet metal including the bumpers, are the same color.

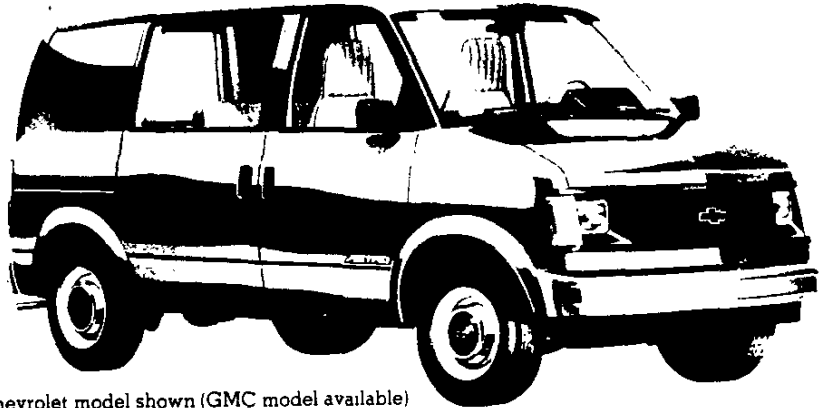

Chevrolet model shown (GMC model available)

SPECIAL TWO-TONE

Special two-tone paint (ZY3), is available on all models and includes a dual color decal stripe located at the belt styling crease line. The areas above the decal are painted color code 1. The areas below the decal, including the bumpers, are painted color code 2.

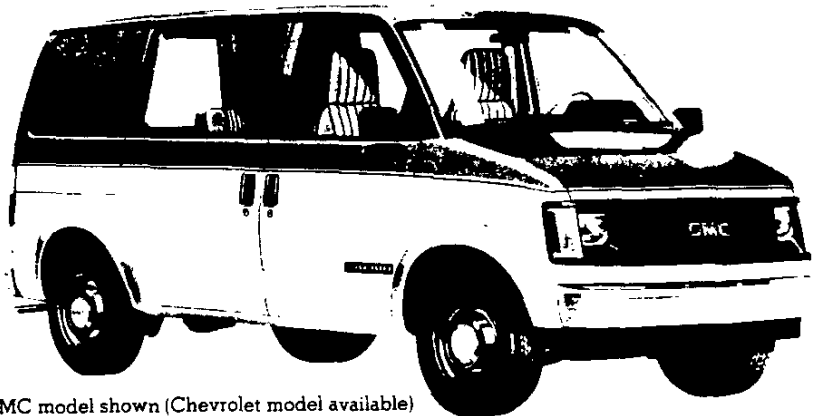

GMC model shown (Chevrolet model available)

SPORT TWO-TONE

Sport two-tone paint (ZY7), which provides a lower accent two-tone scheme, is available on all models (except Astro LT/Safari SLT). Color code 1 is applied to the areas above the lower styling crease line and color code 2 is applied to the areas below, including the bumpers and fender flares.



Chevrolet model shown (GMC model available)

*Optional at extra cost

NOTES

ASTRO/SAFARI SL

(Passenger Van)

Body Ordering Codes:

Astro/Safari SL—ZW9

Astro C5/Safari SLX—YC5

Astro CL/Safari SLE—YC6

Astro LT/Safari SLT—YC7

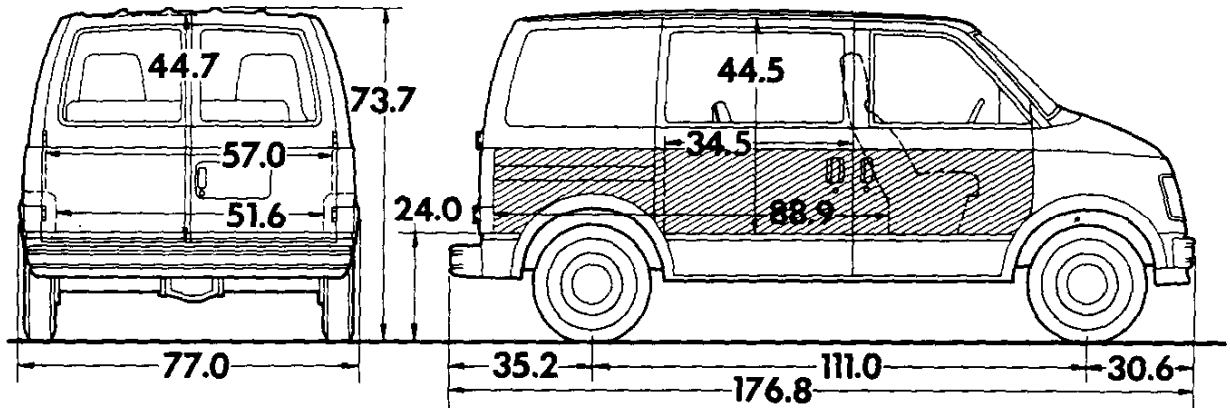

Sign Panel Area (side)
18" x 107"



Capacity (Cu. Ft.)

w/Std. Seating—86.2

w/7- or 8-Pass.—22.7

w/Center Seat Removed—151.8

Model	Body Ordering Code	Engine No. Cyl.	Curb Weight (lb)			Model Weights (lb)*			Ground Clearance (in)* Minimum
			Front	Rear	Total	Front	Rear	Total	
M10906	ZW9	6	1991	1470	3461	2323	1888	4211	7.8
M10906	YC5	6	2019	1525	3544	2351	1943	4294	7.8
M10906	YC6	6	2046	1548	3594	2378	1966	4344	7.8
M10906	YC7	6	2104	1532	3636	2436	1950	4386	7.8

* Dimensions with standard equipment, unloaded.

*Model Weights include curb weight plus occupants (standard seating capacity x 150 lbs.). Total Weight may vary as much as ± 50 lbs. to allow for production build variation.

SEATING CAPACITY SELECTOR

‡Maximum Ratings				Minimum Equipment Required for GVW Rating		
Seating Capacity	GVW Range (lb)	†GAWR (lb)		Tires, Front	Tires, Rear	Chassis Equipment
		Front	Rear			
M10906 MODELS						
•4, •5	4404 to 5055	2685	2685	P195/75R15	P195/75R15	Standard
	4704 to 5354	2700	2900	P205/75R15	P205/75R15	Increased Cargo Capacity (X6X)
•7	4792 to 5410	2700	2900	P205/75R15	P205/75R15	Standard
•8	4742 to 5439	2700	2900	P205/75R15	P205/75R15	Standard

‡GAWRs shown are the maximum for each axle with the equipment listed. Maximum ratings include an additional 50 lbs. allowance for vehicle weight variance.

†GAWR—Gross Axle Weight Rating.

•Requires ZP4, Four-Passenger or ZP5, Five-Passenger Seating.

•Requires ZP7, Seven-Passenger Seating.

♦Requires ZP8, Eight-Passenger Seating.

ASTRO/SAFARI SL

(Passenger Van)

POWER TEAMS

ALL STATES

POWER TEAMS (MUST ORDER ENGINE, TRANSMISSION AND REAR AXLE)

(Consult GVWR Selector and Tire Chart to insure tire capacity and availability)

ENGINE	TRANSMISSION		AXLES				RESTRICTIONS
	5-SP	AUTO	2.73	3.08	3.42	3.73	
W/NA5 STANDARD EMISSION EQUIPMENT							
LB4 V6 4.3 Liter EFI	MM5		GQ1	GU4	—	—	
		MX0	—	GQ1	GU6	*GT4	
W/NA6 HIGH ALTITUDE EMISSION EQUIPMENT							
LB4 V6 4.3 Liter EFI	MM5		—	GQ1	GU6	—	
		MX0	—	GQ1	GU6	*GT4	
W/YF5 CALIFORNIA EMISSION EQUIPMENT							
LB4 V6 4.3 Liter EFI	MM5		GQ1	GU4	—	—	ZP4/ZP5/X6X
	MM5		—	GQ1	GU6	—	ZP7/ZP8/X6X
		MX0	—	GQ1	GU6	*GT4	

*Reqs Z82 Trailering

ENGINE RATINGS— ALL STATES

SAE Net Ratings	4.3 Liter 262 EFI V6
Net Horsepower	150 @ 4000 rpm
Net Torque, lb-ft	230 @ 2400 rpm

ASTRO/SAFARI (PASSENGER VAN)

1987 VEHICLES WITH STANDARD EQUIPMENT

Prices shown are effective with initial shipments of 1987 model motor vehicles

Description	Model Number	Body Code	Wheel Base	Factory D&H(a)	List Price	Mfr's Suggested Retail Price*	Group Number
◆ 6-Cylinder 4.3 Liter (262 Cu. In.) E.F.I. V6 Gasoline Engine-Engine Ordering Code LB4							
M10 Series							
Astro	CM10906	ZW9	111"	N.A.	9833.00	9833.00	13
Astro CS	CM10906	YC5	111"	N.A.	10314.00	10314.00	13
Astro CL	CM10906	YC6	111"	N.A.	11079.00	11079.00	13
Astro LT	CM10906	YC7	111"	N.A.	12370.00	12370.00	13

★ Manufacturer's Suggested Retail Prices do not include applicable destination charges, state and local taxes, license fees, optional equipment or special items or services.

◆ Refer to Power Team Chart for California Emission Certification Requirements.

OPTIONS WHEN INSTALLED BY GENERAL MOTORS

Prices shown are effective with initial shipments of 1987 model motor vehicles

Description	Option Number	Factory D&H(a)	List Price	Mfr's Suggested Retail Price◇
Seat Trim: (See Interior and Exterior Color Selection Chart for ordering information).				
V**4 Standard Vinyl High Back Bucket. Not available when YC6 or YC7 is specified			NO ADDITIONAL CHARGE	
X**4 Custom Vinyl High Back Bucket. Standard on YC6. Not available when YC7 is specified			NO ADDITIONAL CHARGE	
With ZP4 or ZP7 Seating Arrangement			NO ADDITIONAL CHARGE	
With ZP8 Seating Arrangement		N.A.	158.00	158.00
With ZP5 Seating Arrangement		N.A.	106.00	106.00
K**4 Custom Cloth High Back Bucket. Not available when YC7 is specified			NO ADDITIONAL CHARGE	
With YC6			NO ADDITIONAL CHARGE	
With ZP4 or ZP7 Seating Arrangement			NO ADDITIONAL CHARGE	
With ZP8 Seating Arrangement		N.A.	158.00	158.00
With ZP5 Seating Arrangement		N.A.	106.00	106.00
L**6 Velour Reclining Bucket. Standard on YC7			NO ADDITIONAL CHARGE	
With ZP4 or ZP7 Seating Arrangement			NO ADDITIONAL CHARGE	
With ZP5 Seating Arrangement			NO ADDITIONAL CHARGE	
With ZP8 Seating Arrangement			NO ADDITIONAL CHARGE	
Paints, Exterior: (See Interior and Exterior Color Selection Chart for Ordering Information and Paint Application).				
Solid	ZY1		NO ADDITIONAL CHARGE	
Special Two-Tone				
Without YC7. Includes D85 Striping	ZY3	N.A.	251.00	251.00
With YC7	ZY3	N.A.	172.00	172.00
Sport Two-Tone. Not available when YC7 is specified	ZY7	N.A.	172.00	172.00
Emission Systems: Dealer Note -- One of the following emission options must be specified. (See Power Teams Chart for availability and complete specifications) California Emission Requirements. Includes all testing, equipment and/or certification necessary for registration in the State of California. Not available when NA6 High Altitude or NA5 Standard Emissions is specified.				
High Altitude Emission Equipment. Not available when YF5 California Emissions is specified	YF5	N.A.	99.00	99.00
Standard Emission Equipment. Not available when YF5 California or NA6 High Altitude Emissions are specified	NA6		NO ADDITIONAL CHARGE	
.....	NA5		NO ADDITIONAL CHARGE	
Engines: (See Power Teams Chart for availability and complete specifications) Gasoline.				
4.3 Liter (262 Cu. In.) E.F.I. V6.	LB4		NO ADDITIONAL CHARGE	
Transmissions:				
4-Speed Automatic with Overdrive.	MX0	N.A.	550.00	550.00
5-Speed Manual with Overdrive. Standard	MM5		NO ADDITIONAL CHARGE	
Axles, Rear: (See Power Teams Chart for option number selection, availability and complete specifications)				
Optional Ratio		N.A.	38.00	38.00
Locking Differential. Includes T145/80D18 Compact Spare Tire	G80	N.A.	252.00	252.00

(a) D & H Charges on vehicle and optional equipment include reimbursement to ordering Division for any tax that it has paid, incurred or agreed to pay thereon.

◇ State and local taxes not included.

ASTRO/SAFARI (PASSENGER VAN)

OPTIONS WHEN INSTALLED BY GENERAL MOTORS

Prices shown are effective with initial shipments of 1987 model motor vehicles

Description	Option Number	Factory D&H(a)	List Price	Mfr's Suggested Retail Price◇
Tires:				
<i>All rim sizes are 6.00 except when ZJ7 Rally Wheels are specified.</i>				
TUBELESS. Includes Compact Spare Tire				
<i>P195/75R15 All Seasons Steel Belted Radial Ply Blackwall.</i>				
(Standard)	QAR		NO ADDITIONAL CHARGE	
<i>P195/75R15 All Seasons Steel Belted Radial Ply Whitewall</i>	QAS	N.C.	68.00	68.00
<i>P205/75R15 All Seasons Steel Belted Radial Ply Blackwall</i>	QCE	N.C.	33.00	33.00
<i>P205/75R15 All Seasons Steel Belted Radial Ply Whitewall</i>	QCG	N.C.	105.00	105.00
<i>P205/75R15 All Seasons Steel Belted Radial Ply White Lettered</i>	QCF	N.C.	129.00	129.00

OTHER OPTIONS

Air Conditioning: All Weather. Available only when N40 Power Steering is specified. Includes V01 H.D. Radiator when V02 H.D. Radiator and Transmission Oil Cooler is not specified.				
<i>Front. Instrument panel mounted. Recommended for front seat area cooling only.</i>				
Without YC5, YC6 or YC7	C60	N.A.	781.00	781.00
With YC5, YC6 or YC7	C60	N.A.	736.00	736.00
<i>Front and Rear. Front instrument panel mounted and rear overhead systems. Available only when YC5, YC6 or YC7 is specified.</i>				
	C89	N.A.	1320.00	1320.00
Air Dam with Fog Lamps				
	ANL	N.A.	115.00	115.00
Battery: Heavy-Duty. 12-Volt, 630 Cold Cranking Amps Delco Freedom. Included when V10 Cold Climate Package is specified				
	UA1	N.A.	56.00	56.00
Bumper Equipment:				
<i>Bumpers, Deluxe Front and Rear. Chromed with color-keyed end caps and black rub strips.</i>				
Without YC6 or YC7	VE5	N.A.	128.00	128.00
With YC6 or YC7	VE5	N.A.	76.00	76.00
<i>Bumpers. Color-Keyed with color-keyed end caps and black rub strips. Standard on YC6 and YC7</i>				
	VE6	N.A.	52.00	52.00
Cargo Capacity, Increased: Available only when ZP4 or ZP5 Seating Arrangement and P205 Tires are specified. Includes F59 Stabilizer Bar and N40 Power Steering				
	X6X	N.A.	334.00	334.00
	V54	N.A.	126.00	126.00
	P18	N.A.	22.00	22.00
Carrier, Luggage: Black				
Carrier, Spare Tire: Includes hoist. Standard on YC5, YC6 and YC7.				
Cooling Systems:				
<i>Engine Oil. Included with Z82 Trailing Special. Available only when V01 H.D. Radiator or V02 H.D. Radiator and Transmission Oil Cooler is specified</i>				
	KC4	N.A.	126.00	126.00
<i>Radiator, Heavy-Duty: Included when C60 Front or C69 Front and Rear Air Conditioning is specified without V02 H.D. Radiator and Transmission Cooler Radiator and Transmission Oil, Heavy-Duty. Included with Z82 Trailing Special. Available only when MX0 Automatic Transmission is specified. Not available when V01 H.D. Radiator is specified</i>				
Without C60 Front or C69 Front and Rear Air Conditioning	V02	N.A.	118.00	118.00
With C60 Front or C69 Front and Rear Air Conditioning	V02	N.A.	63.00	63.00
Cold Climate Package: Includes K05 Engine Block Heater, UA1 H.D. Battery and anti-freeze protection to -32 degrees.				
Without YC5, YC6 or YC7				
Without C60 Front or C69 Front and Rear Air Conditioning. Also includes C42 Deluxe Heater and Defogger	V10	N.A.	150.00	150.00
With YC5, YC6 or YC7				
With C60 Front or C69 Front and Rear Air Conditioning.	V10	N.A.	105.00	105.00
Console, Roof: Available only when TR9 Auxiliary Lighting, YC6 or YC7 is specified. Includes dome lamp, map lamps and two stowage compartments				
	DK6	N.A.	83.00	83.00
Door Lock System, Power: All Doors. Included when ZQ2 Operating Convenience Package is specified				
	AU3	N.A.	211.00	211.00
Filler Door, Fuel: Inside Remote Release. Standard on YC5, YC6 and YC7				
	N08	N.A.	27.00	27.00

(a) D & H Charges on vehicle and optional equipment include reimbursement to ordering Division for any tax that it has paid, incurred or agreed to pay thereon.

◇ State and local taxes not included.

ASTRO/SAFARI (PASSENGER VAN)

OPTIONS WHEN INSTALLED BY GENERAL MOTORS

Prices shown are effective with initial shipments of 1987 model motor vehicles

Description	Option Number	Factory D&H(a)	List Price	Mfr's Suggested Retail Price ◊
OTHER OPTIONS				
Floor Covering:				
<i>Carpeting, Wheelhousing and Floor. Standard on YC6 and YC7. Available only when YC5 is specified</i>	B30	N.A.	117.00	117.00
<i>Rubber, Wheelhousing and Floor. Color-Keyed. Standard on YC5. Not available on YC6 or YC7</i>	BG9	N.A.	45.00	45.00
<i>Mats, Color-Keyed, Removable. Available only when YC5, YC6 or YC7 and B30 Carpeting is specified.</i>				
With ZP4 4 Passenger or ZP5 5 Passenger Seating Arrangement	B37	N.A.	47.00	47.00
With ZP7 7 Passenger or ZP8 8 Passenger Seating Arrangement	B37	N.A.	69.00	69.00
Gages: <i>Voltmeter, Temperature, Oil Pressure and Trip Odometer. Standard on YC6 and YC7</i>	Z53	N.A.	62.00	62.00
Glass Arrangements: <i>Complete Body. Available only when P18 Spare Wheel Carrier, YC5, YC6 or YC7 is specified</i>	ZW6	N.A.	128.00	128.00
Glass, Tinted:				
<i>All Windows. Includes A02 Windshield Glass.</i>				
Without ZW6 Complete Body Glass	A01	N.A.	75.00	75.00
With ZW6 Complete Body Glass	A01	N.A.	104.00	104.00
<i>Windshield only. Included when A01 Tinted, AA3 Deep Tinted or AJ1 Deep Tinted Glass is specified</i>	A02	N.A.	40.00	40.00
<i>Deep Tinted. Not available when A01 Tinted Glass is specified. Includes tinted glass on passenger and driver's side door. Also includes A02 Windshield Glass and dark coated glass on side windows and rear door.</i>				
Without ZW6 Complete Body Glass	AJ1	N.A.	236.00	236.00
With ZW6 Complete Body Glass	AJ1	N.A.	365.00	365.00
<i>Deep Tinted with Light Tinted Rear Window. Not available when A01 Tinted or AJ1 Deep Tinted Glass is specified. Includes tinted glass on passenger, driver's side and rear doors. Also includes A02 Tinted Windshield and dark coated glass on side windows.</i>				
Without ZW6 Complete Body Glass	AA3	N.A.	185.00	185.00
With ZW6 Complete Body Glass	AA3	N.A.	308.00	308.00
Glass, Swing-Out: <i>Rear door. Standard on YC7</i>	A18	N.A.	59.00	59.00
Grille, Deluxe: <i>Black with Argent Trim. Standard on YC6 and YC7</i>	TL1	N.A.	27.00	27.00
Harness, Wiring: <i>Trailer, 5-lead. Not available when Z82 Trailing Special is specified. Included with Z72 Trailing Special</i>	U89	N.A.	41.00	41.00
Headlamps: <i>Halogen.</i>	TT4	N.A.	24.00	24.00
Heaters:				
<i>Engine Block. 600 Watts, 120 Volts. Included when V10 Cold Climate Package is specified</i>	K05	N.A.	33.00	33.00
<i>Rear. Located on left side, forward of rear fender wall</i>	C36	N.A.	267.00	267.00
<i>Deluxe, Heater and Defogger. Included with V10 Cold-Climate Package, YC5, YC6 or YC7. Not available when C60 Front or C69 Front and Rear Air Conditioning is specified</i>	C42	N.A.	45.00	45.00
Lamp: Dome and Reading. <i>Available only when YC6, YC7 or TR9 Auxiliary Lighting is specified. Not available when DK6 Roof Console is specified</i>	C95	N.A.	33.00	33.00
Lighter, Cigarette: <i>Includes ash tray light. Included with TR9 Auxiliary Lighting.</i>	U37	N.A.	32.00	32.00
Lighting, Auxiliary: <i>Included with YC6 or YC7. Includes U37 Cigarette Lighter, glove box and convenience tray lamps, door jamb switches on all doors, stepwall lamps for front and sliding doors and door jamb defeat switch</i>				
Without YC5. Also includes headlamp warning chimes	TR9	N.A.	149.00	149.00
With YC5	TR9	N.A.	128.00	128.00
Mirrors:				
<i>Deluxe LH and RH, Below Eye-Line. Painted, Black</i>	D44	N.A.	52.00	52.00
<i>Visor, Vanity, Illuminated, RH. Available only when Custom Cloth or Custom Vinyl Trim is specified.</i>				
Without YC5, YC6 or YC7	D64	N.A.	50.00	50.00
With YC5, YC6 or YC7	D64	N.A.	43.00	43.00
Moldings:				
<i>Body Side, Black. Standard on YC6 and YC7</i>	B84	N.A.	59.00	59.00
<i>Wheel Opening, Black. Standard on YC6 and YC7</i>	B96	N.A.	31.00	31.00
<i>Guards, Door Edge. Black</i>	B93	N.A.	18.00	18.00

(a) D & H Charges on vehicle and optional equipment include reimbursement to ordering Division for any tax that it has paid, incurred or agreed to pay thereon.

◊ State and local taxes not included.

ASTRO/SAFARI (PASSENGER VAN)

OPTIONS WHEN INSTALLED BY GENERAL MOTORS

Prices shown are effective with initial shipments of 1987 model motor vehicles

Description	Option Number	Factory D&H(a)	List Price	Mfr's Suggested Retail Price◇
OTHER OPTIONS				
Operating Convenience Package: Includes AU3 Power Door Locks and A31 Power Windows	ZQ2	N.A.	411.00	411.00
Panels, Interior: Protective closeout for Lower Quarter. Not available when YC5, YC6, YC7, ZP7 or ZP8 Seating Arrangement is specified	E48	N.A.	27.00	27.00
Preliminary Price Information	B3W	N.A.	N.A.	N.A.
Radio Equipment:				
AM Radio. Includes dual front speakers	U63	N.A.	122.00	122.00
AM/FM Radio. Includes dual front speakers	U69	N.A.	181.00	181.00
AM/FM Stereo Radio. Electronically Tuned. Includes dual front speakers.				
Without YC5, YC6 or YC7. Also includes wiring for rear speakers	UU9	N.A.	253.00	253.00
With YC5, YC6 or YC7. Also includes four rear speakers	UU9	N.A.	293.00	293.00
AM/FM Stereo Radio with Seek and Scan and Digital Clock. Electronically Tuned. Includes dual front speakers.				
Without YC5, YC6 or YC7. Also includes wiring for rear speakers	UM7	N.A.	308.00	308.00
With YC5, YC6 or YC7. Also includes four rear speakers	UM7	N.A.	347.00	347.00
AM/FM Stereo Radio with Seek and Scan, Stereo Cassette Tape and Digital Clock. Electronically Tuned.				
Without YC5, YC6 or YC7. Also includes wiring for rear speakers	UM6	N.A.	434.00	434.00
With YC5, YC6 or YC7. Also includes four rear speakers	UM6	N.A.	474.00	474.00
AM Stereo and FM Stereo Radio with Seek and Scan, Stereo Cassette Tape with Search and Repeat, Graphic Equalizer and Digital Clock. Electronically Tuned.				
Without YC5, YC6 or YC7. Also includes wiring for rear speakers	UX1	N.A.	584.00	584.00
With YC5, YC6 or YC7. Also includes four rear speakers	UX1	N.A.	624.00	624.00
Seating Arrangements: One of the following seat options must be specified.				
Four Passenger Seating. Includes Four Bucket Seats, 2-Front and 2-Midship. Includes seat adjuster, seat belts and A78 Seat Back Recliner and Dual Armrests on all seats. Deletes standard center seat. Not available when standard vinyl trim is specified.				
Without YC6 or YC7	ZP4	N.A.	670.00	670.00
With YC6	ZP4	N.A.	583.00	583.00
With YC7	ZP4	NO ADDITIONAL CHARGE		
Five Passenger Seating. Standard. Includes two front bucket seats and seat belts. Without YC7, also includes R.H. Armrest and fold-down feature on bench seat. With YC7, also includes fold-down center console with convenience tray and reclining seat backs				
	ZP5	NO ADDITIONAL CHARGE		
Seven Passenger Seating. Includes ZP4 Four Bucket Seats, A78 Seat Back Recliner and Dual Armrests, seat belts, three passenger rear bench seat and armrests mounted on rear wheelhousings, N40 Steering and F59 Front Stabilizer. Without YC7, also includes fold-down feature on rear seat. With YC7, also includes fold-down center console with convenience tray and reclining seat backs. Available only when P205 Tires are specified. P18 Spare Wheel Carrier must be specified without YC5, YC6 or YC7				
Without YC6 or YC7	ZP7	N.A.	1351.00	1351.00
With YC6	ZP7	N.A.	1263.00	1263.00
With YC7	ZP7	N.A.	1160.00	1160.00
Eight Passenger Seating. Includes ZP5 5-passenger seating, three passenger rear seat, N40 Power Steering and F59 Front Stabilizer. Also includes seat belts and R.H. armrest on center seat. Rear seat includes seat belts and armrests mounted on rear wheelhousings. Without YC7, also includes fold-down feature on center and rear seats. With YC7 also includes fold-down center console with convenience tray and reclining seat backs. Available only when P205 Tires are specified. P18 Spare Wheel Carrier must be specified without YC5, YC6 or YC7				
Without YC6 or YC7	ZP8	N.A.	626.00	626.00
With YC6	ZP8	N.A.	678.00	678.00
With YC7	ZP8	N.A.	1160.00	1160.00
Seat Back Recliner and Dual Armrests: For high back driver and front passenger seats only. Available only when Custom Trim is specified. Included when YC7, ZP4 or ZP7 Seating Arrangement is specified.				
	A78	N.A.	241.00	241.00
Shock Absorbers: Heavy Duty. Front and Rear				
	F51	N.A.	36.00	36.00
Speed Control, Electronic				
	K34	N.A.	205.00	205.00

(a) D & H Charges on vehicle and optional equipment include reimbursement to ordering Division for any tax that it has paid, incurred or agreed to pay thereon.

◇ State and local taxes not included.

ASTRO/SAFARI (PASSENGER VAN)

OPTIONS WHEN INSTALLED BY GENERAL MOTORS

Prices shown are effective with initial shipments of 1987 model motor vehicles

Description	Option Number	Factory D&H(a)	List Price	Mfr's Suggested Retail Price [◇]
OTHER OPTIONS				
Stabilizer Bar: Front. Included with X6X Increased Cargo Capacity, ZP7 or ZP8 Seating Arrangement	F59	N.A.	40.00	40.00
Steering:				
Power. Available only when F59 Front Stabilizer Bar is specified. Included with X6X Increased Cargo Capacity, ZP7 or ZP8 Seating Arrangement.	N40	N.A.	292.00	292.00
Power, Not Desired	N51	NO ADDITIONAL CHARGE		
Steering Wheels:				
Comfortilt	N33	N.A.	121.00	121.00
Custom. Standard on YC6	N31	N.A.	28.00	28.00
Luxury Sport. Standard on YC7				
Without YC6	NK3	N.A.	35.00	35.00
With YC6	NK3	N.A.	7.00	7.00
Stop, Positive: Rear Door. Standard on YC5, YC6 and YC7	AD8	N.A.	37.00	37.00
Striping, Body: Not available when ZY7 Sport Two-Tone Paint or YC7 is specified. With ZY1 Solid Paint, available only when the following stripe color is specified. Included with ZY3 Special Two-Tone Paint	D85	N.A.	79.00	79.00
Stripe Color: Available only when ZY1 Solid Paint and D85 Striping are specified. (Refer Color and Trim Chart for option availability)				
Blus with Silver Border	25A	NO ADDITIONAL CHARGE		
Gold with Black Border	53A	NO ADDITIONAL CHARGE		
Orange with Black Border	58A	NO ADDITIONAL CHARGE		
Red with Black Border	74A	NO ADDITIONAL CHARGE		
Red with Silver Border	71A	NO ADDITIONAL CHARGE		
Tan with Black Border	63A	NO ADDITIONAL CHARGE		
Tank, Fuel: Approximately 27-gallon capacity. Replaces production fuel tank	NL9	N.A.	70.00	70.00
Tie-Downs, Cargo: Available only when ZP4 or ZP5 Seating Arrangement and X6X Increased Cargo Capacity are specified	AP1	N.A.	32.00	32.00
Trailer Hitch: Deadweight Type. Not available when Z82 Trailering Special is specified. Included with Z72 Trailering Special	VR2	N.A.	68.00	68.00
Trailering Special Equipment: (See Trailering Guide for GCW Ratings with available power train combinations.)				
Heavy-Duty. Includes Weight Distributing Hitch Platform, H.D. flashers, H.D. 7 Lead Wiring Harness, KC4 Engine Oil Cooler and V02 H.D. Radiator and Transmission Oil Cooler. Available only when N40 Power Steering, UA1 H.D. Battery, F51 H.D. Shock Absorbers, F59 Stabilizer and MX0 Automatic Transmission are specified. Also available only when 3.42 or 3.73 Rear Axle Ratio is specified				
Without C60 Front or C69 Front and Rear Air Conditioning	Z82	N.A.	555.00	555.00
With C60 Front or C69 Front and Rear Air Conditioning	Z82	N.A.	498.00	498.00
Light-Duty. Includes VR2 Deadweight Trailer Hitch, H.D. flashers and U89 5 Lead Wiring Harness. Available only when MX0 Transmission and V01 H.D. Radiator or V02 H.D. Radiator and Transmission Oil Cooler and 3.08 or 3.42 Rear Axle Ratio are specified.	Z72	N.A.	109.00	109.00
Wheel Trim:				
Wheel Covers, Bright Metal. Includes black wheel. Standard on YC6. Not available when YC7 is specified	P01	N.A.	42.00	42.00
Trim Rings. Includes black wheel. Included with ZJ7 Rally Wheels. Not available when YC6 or YC7 is specified	P06	N.A.	60.00	60.00
Wheels:				
Rally, 6.5". Argent. Includes special hub caps and P06 Trim Rings. Color-Keyed on YC7. Standard on YC7				
Without YC8	ZJ7	N.A.	92.00	92.00
With YC6	ZJ7	N.A.	50.00	50.00
Aluminum, Cast: Four wheels only. Includes 15" x 6.5" wheels and special hub caps.				
Without YC6 or YC7	PF3	N.A.	316.00	316.00
With YC6	PF3	N.A.	274.00	274.00
With YC7. Wheels are Color-Keyed	PF3	N.A.	224.00	224.00
Windows: Power. Front side doors only. Included when ZQ2 Operating Convenience Package is specified	A31	N.A.	200.00	200.00

(a) D & H Charges on vehicle and optional equipment include reimbursement to ordering Division for any tax that it has paid, incurred or agreed to pay thereon.

◇ State and local taxes not included.

ASTRO/SAFARI SL

CAB & BODY FEATURES SEATING ARRANGEMENTS COLOR & TRIM CHARTS TWO-TONES

ASTRO/SAFARI SL

(Passenger Van)

STANDARD MODEL—BODY ORDERING CODE—ZW9

The standard model includes the following items as standard equipment

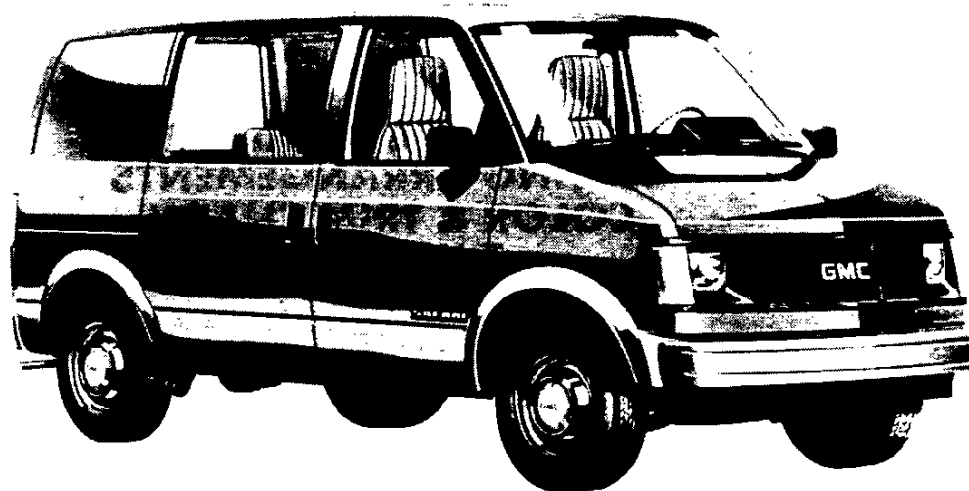
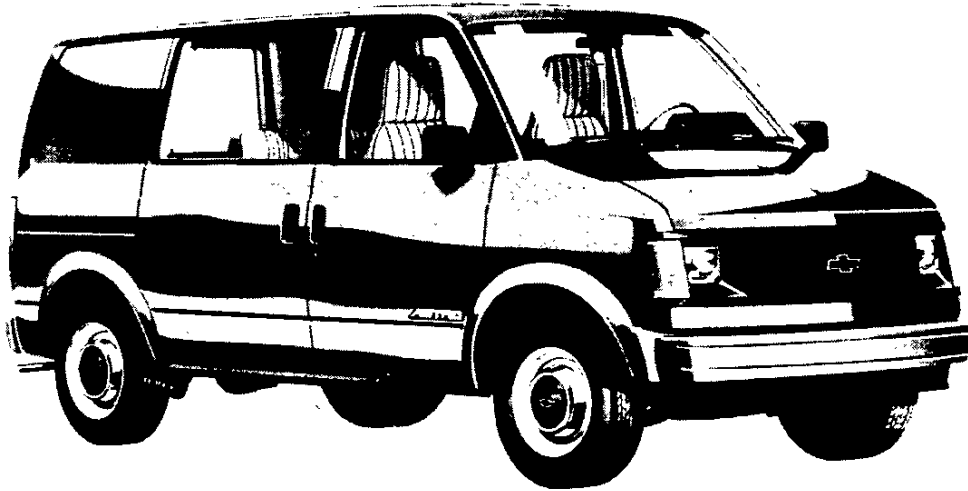

EXTERIOR

- **Bumpers:** Front and rear; painted lower body color
- **Colors:** See Interior and Exterior Color Selection Chart
- **Doors:** RH and LH front side doors; RH and LH rear load doors; and a RH sliding side load door
- **Door Opening and Locking Methods:**
 - Front side doors: Outside flush pull-out type door handle with separate key lock
 - Sliding side load door: Outside flush pull-out type handle releases both front and rear latches; for opening and closing of door from inside, reverse outside procedure
 - RH and LH rear doors: Flush pull-out type RH door handle opens door, and after opening RH door, LH door latch is released by inside handle; key lock cylinder in RH door
- **Glass:** Windshield; RH and LH front side door drop glass; side swing-out sliding door glass; RH and LH rear door glass; and LH front swing-out quarter glass
- **Grille:** Molded plastic; painted black; integral Chevrolet emblem/GMC letters at center
- **Headlamps/Parking Lamps:** Headlamp/parking lamp bezels painted black
- **Horns:** Dual, electric, low- and high-note
- **Hub Caps:** Bright metal with black trim
- **Keys:** Two-key system with separate keys for ignition switch and doors
- **Lights:**
 - Backup lamps: Two rear (integral with taillamps)
 - Combination parking/direction/hazard: Two front
 - Combination tail/stop/direction/hazard: Two rear
 - Headlamps: Two; Rectangular
 - License plate lamp: Single rear
 - Side marker lamps with reflectors: Integral with front parking lamps and rear taillamps
- **Mirrors:** RH and LH painted black; pivoting arm with adjustable 34.1 sq. in. head
- **Nameplates:** Bright "Astro/Safari" plate on front doors; "Chevrolet/GMC" letters plate on RH rear door in license plate housing
- **Tools:** Screw operated scissor-type jack with ratchet handle, extension and two wheel blocks
- **Undercoating:** Hot melt wax on entire underbody
- **Wheels:** Painted argent
- **Windshield Wipers and Washers:** Electric, 2-speed wipers with black finish on exposed metal portions; wet-arm design demand-type washer system

ASTRO/SAFARI SL

(Passenger Van)

STANDARD MODEL—BODY ORDERING CODE—ZW9

The standard model includes the following items as standard equipment

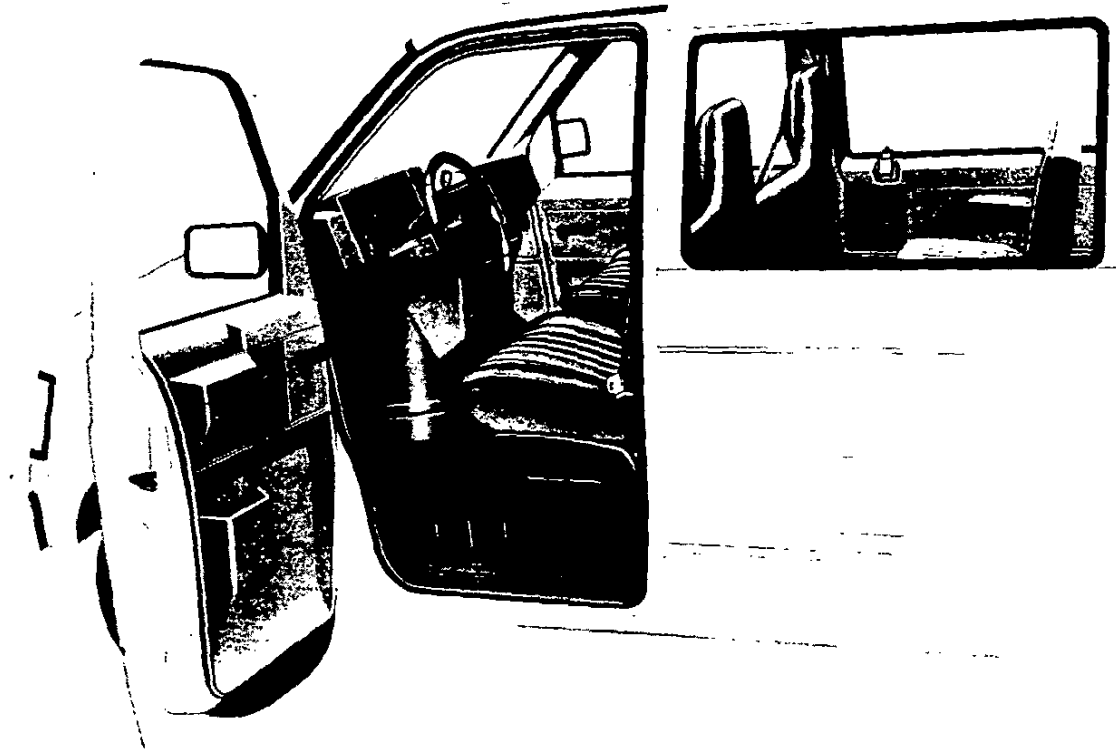

INTERIOR

- **Air Vents:** Integral with heater
- **Armrests:** LH and RH
- **Ashtray:** At center in engine cover console
- **Coat Hooks:** On LH roof rail to rear of driver's seat
- **Colors:**
 - Painted areas: Same as exterior primary color choice
 - Interior trim: Coordinated with seat trim color choice
- **Dome Lamps:** Two; with front door-actuated switches (dome lamps may also be activated by main light switch)
- **Door Locks:** Inside lock/release for front doors and sliding side door
- **Door Seals:** Latex foam rubber
- **Floor Covering:** Embossed black rubber mats on entire floor area
- **Headliner:** Color-keyed molded styrofoam with foam and cloth cover; driver area
- **Heater and Defogger:** Deluxe-air
- **Hood Lock Release:** Handle located on RH side of instrument panel
- **Instruments:**
 - Gages: Speedometer, odometer, and fuel
 - Switches: Main, for control of exterior lights, instrument lights and dome lights, multi-function switch on steering column for direction signals by moving lever up or down (includes lane change position), headlight beams by pulling lever toward driver, windshield wiper by turning band marked "WIPER" toward or away from driver, and windshield washer by pushing in the lever knob; ignition with key-in warning buzzer, hazard warning; heater fan, door-operated dome lamp

Warning lights: Generator, oil pressure, engine temperature, service-parking brake, direction/hazard signal, and high beam

- **Instrument Panel:** Molded black plastic faceplate
- **Insulation and Sound Deadening Material:** Dash (firewall), front floor panel, engine cover front extension and inside engine cover
- **Lights:** Instruments, front and rear dome
- **Seat:** Front high back bucket driver and front passenger; adjustable; all-vinyl trim; foam padded plus center removable 3-passenger bench seat. Also available at extra cost. High back center bucket seats and rear 3-passenger bench seat in standard vinyl, Custom vinyl or Custom Cloth. See Interior and Exterior Color Selection Chart for color and trim availability
- **Seat Belts:** Color-keyed with pushbutton release for all seating positions
- **Spare Tire Carrier:** LH rear side
- **Steering Wheel and Column:** 15.24" diameter black vinyl wheel; black energy-absorbing steering column with anti-theft locking feature
- **Stowage Box:** In front face of engine cover extension; with latched door; includes beverage holder provisions
- **Sunshade:** LH and RH, color-keyed
- **Trim Panels:** Injection molded plastic panels on front and sliding side doors; with storage pockets on front side doors

ASTRO/SAFARI SL

(Passenger Van)

ASTRO CS/SAFARI SLX MODEL—BODY ORDERING CODE YC5

This option includes all exterior items listed for the standard model plus the following additions or substitutions

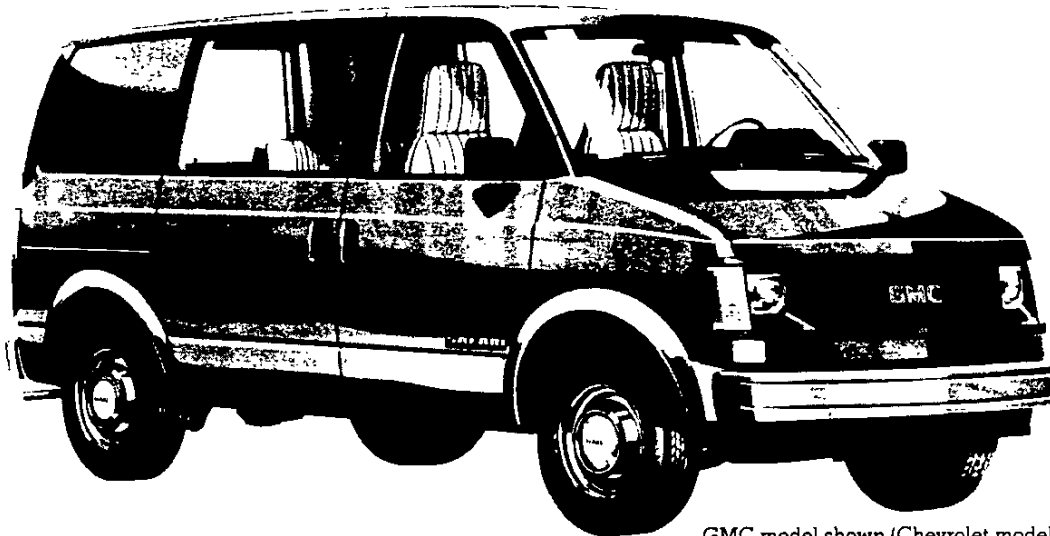

GMC model shown (Chevrolet model available)

EXTERIOR

- **Bright Appearance Items:**
Bright applied Chevrolet emblem/GMC letters at grille center
- **Black Painted Window Pillars**

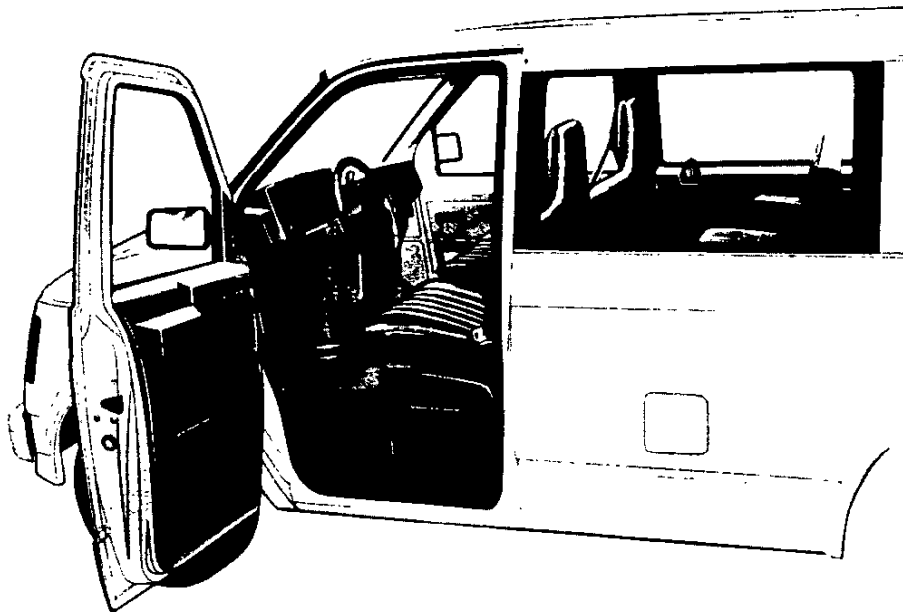

INTERIOR

- **Bright Appearance Items:**
"Astro CS/Safari SLX" lettering and trim on instrument panel
- **Coat Hooks:** LH and RH side, retractable, on roof rails
- **Floor Covering:** Color-keyed rubber mats; for entire floor area, including front and rear wheelhousings
- **Fuel Filler Door:** With remote release
- **Garnish Moldings:** Color-keyed plastic moldings for rear compartment side windows, front and rear roof header panels, roof front side rails and windshield pillars, front door lock pillars, lower sliding door hinge pillar, and sliding door track and roller bracket
- **Headliner:** Full-length, color-keyed; foam-backed cloth
- **Heater and Defogger:** Deluxe air with side window defogger
- **Insulation:** Above headliner and on wheelhousing areas
- **Jack and Tool Cover:** Molded, color-keyed plastic in RH rear quarter area
- **Positive Rear Door Stops**
- **Sill Plates and Stepwell Mats:** Black plastic, on all door openings
- **Spare Tire Carrier:** Under floor
- **Storage Compartment:** Molded, color-keyed plastic in LH rear quarter area
- **Sunshades:** RH and LH color-keyed cloth; with RH visor vanity mirror
- **Trim Panels:** Colored-keyed vinyl on doors and sidewalls with map pockets on front doors

ASTRO/SAFARI SL

(Passenger Van)

ASTRO CL/SAFARI SLE MODEL—BODY ORDERING CODE YC6

This model includes all items listed for Astro CS/Safari SLX model option plus the following additions or substitutions



Chevrolet model shown (GMC model available)

EXTERIOR

- **Bumpers:** With end caps and black combination top step surface and rub strip
- **Grille:** Chevrolet—Black with argent paint on feature surfaces with bright applied Chevrolet emblem
GMC—Black with argent paint on feature surfaces and bright applied GMC letters with red paint fill
- **Moldings:** Black body side and wheel opening
- **Wheel Covers:** Bright

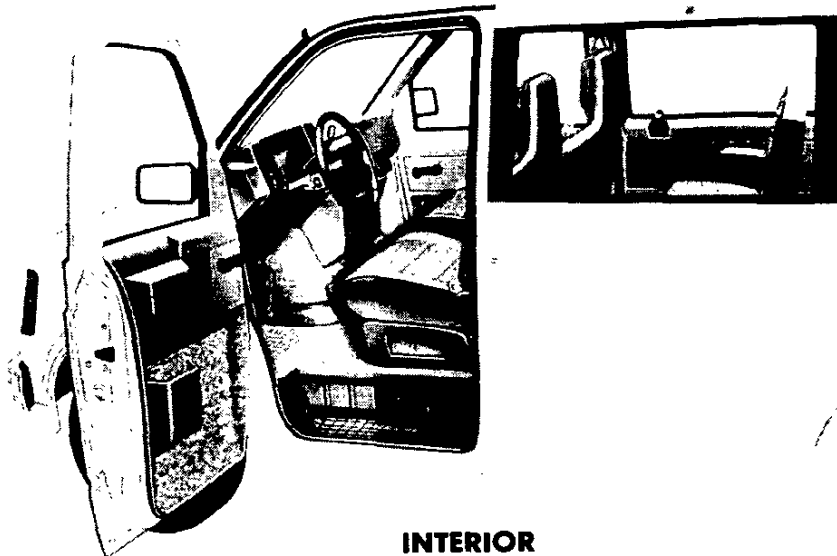

INTERIOR

- **Bright Appearance Items:** "Astro CL/Safari SLE" lettering and trim on instrument panel
- **Cigarette Lighter:** With ashtray light
- **Floor Covering:** Color-keyed carpeting; over entire floor area including front and rear wheelhousings; lower portion of engine cover and vertical walls of front and rear side door stepwells
- **Headlamp Warning Chimes**
- **Instrument Cluster:** Voltmeter, oil pressure gage and engine temperature gage replace warning lamps; also includes trip odometer
- **Kick Panels:** Color-keyed with carpet inserts
- **Lights:** Stowage box and convenience tray, step-well lamps
- **Seats:** High-backed driver and front passenger bucket seats, and standard rear passenger seat with choice of: 1) Custom vinyl trim; or 2) Custom cloth/vinyl trim. See Interior and Exterior Color Selection Chart for color and trim availability.
- **Steering Wheel:** Custom
- **Switches:** Dome lamp doorjamb switches for sliding side and rear doors; also includes doorjamb defeat switch
- **Trim Panels:** Color-keyed expanded vinyl with carpet inserts and insulation

ASTRO/SAFARI SL

(Passenger Van)

ASTRO LT/SAFARI TOURING MODEL—BODY ORDERING CODE YC7

This model includes all items listed for Astro CL/Safari SLE model option plus the following additions or substitutions



EXTERIOR

- **Glass:** Swing-out rear door glass.
- **Nameplates:** Special nameplates on front side door "B" pillars.
- **Special Paint:** Choice of two special paint colors: Sapphire Blue Metallic or Caramel Brown Metallic.
- **Striping:** Wide, color-keyed, graduated-tone stripe at beltline.
- **Wheels:** Rally Wheels are color-coordinated with exterior color choice.

INTERIOR

- **Ash Tray:** On LH side of center seat.
- **Color-Keyed Components:** Seat pocket trim; scuff plate and sill plates; window and engine cover latches; and, when radio is ordered, rear speaker grilles.
- **Interior Trim:** Padded, covered with special velour fabric to match seats.
- **Nameplates:** On glove box door.
- **Seats:** Special front bucket seats with reclining backs, folding integral armrests and full-width adjustable headrests. Split-back center bench seat includes fold-down center console with convenience tray and cup pockets. When in the upright position, the console forms a seat-back for the center seating position. Outboard positions have adjustable headrest. All seats are trimmed with special velour fabric. RH seat-back of center bench seat also folds forward for easy access to rear of vehicle.
- **Steering Wheel:** Special luxury sport type.
- **Storage Pouch:** On LH side of center seat; with zipper.

ASTRO/SAFARI SL (PASSENGER VAN) BODY CONSTRUCTION FEATURES

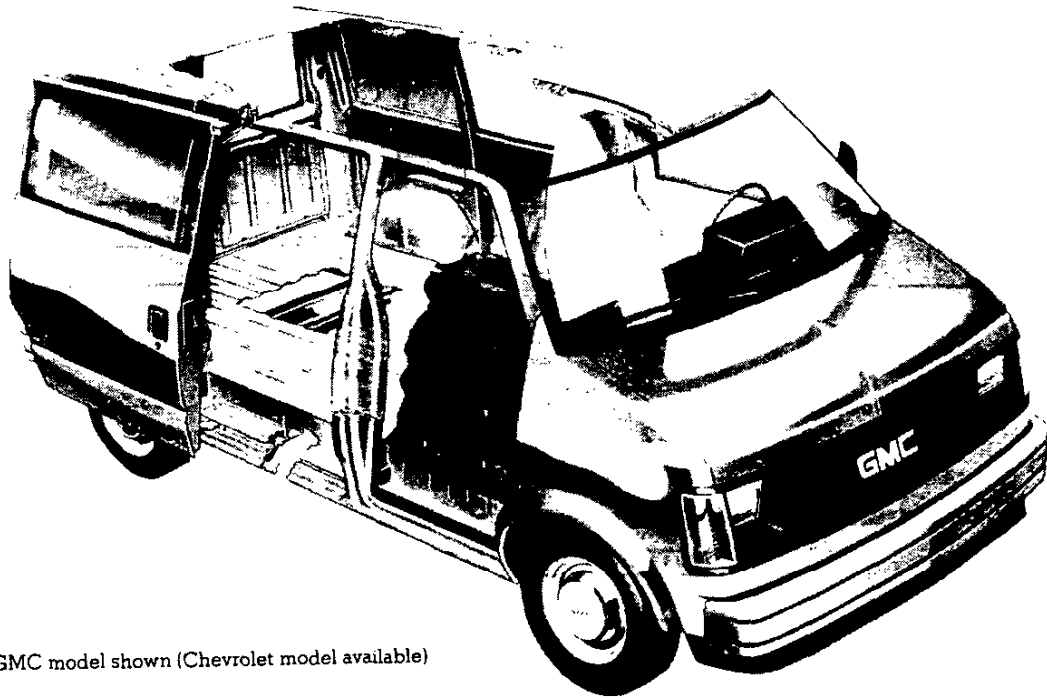

GMC model shown (Chevrolet model available)

BODY CONSTRUCTION FEATURES

- Computer-aided design.
- All-steel construction (except cowl panel).
- Body-frame integral construction for outstanding structural rigidity and excellent durability.
- Comprised of underbody structure, front end structure, left- and right-hand side panel structures and a roof panel structure.
- Longitudinal side rails, cross sills and outriggers form the integral frame to which front and rear floor panels are welded, completing the underbody structure. Main structural members are of heavy-gage steel. A step well is incorporated in the underbody in the area adjacent to the front doors and sliding side door to provide convenient entry and exit.
- Floor panel provides for available underfloor spare tire carrier.

FRONT END STRUCTURE

- Engine compartment with inside opening hood panel allows quick access to service points such as engine, radiator, brake system, battery and windshield washer reservoir.
- The radiator support upper tie bar is mechanically attached to facilitate engine removal.
- A plenum chamber with high-level air intake is utilized in the front end structure to assure a plentiful supply of dry, outside air for interior heating and ventilating as well as to add rigidity to the overall body structure. Air outlets to the interior are provided on the left-hand and right-hand sides by manually controlled doors (RH door omitted with optional air conditioning).
- Bolt-on front fenders for ease of serviceability.

SIDE PANEL STRUCTURES

- Seamless, one-piece outer panels reinforced with one-piece inner panel construction.
- Roof is welded to side panels.
- Inner side panels are welded to floor panel at bottom, leaving no exterior exposed welds.
- Many window configurations available.
- Front quarter and side door glass available on cargo model, standard on passenger van model.
- Optional rear quarter glass is fixed.
- All window openings are of one-piece stamped construction for excellent fit and corrosion resistance.
- Provision is made at the center of LH side panel for fuel filler door. Inside remote operation of door is available as an option.
- RH side panel incorporates center track for sliding door, providing low operating effort.
- Flush-mounted side glass.

ROOF PANELS

- One-piece design.
- Four longitudinal stiffening ribs.
- Welded to side panels.
- Eliminates exposed drip gutters.
- Center rear surface of panel is free of stiffening ribs to allow roof vent installation.
- Four roof bows support the roof panel.

ADDITIONAL BODY FEATURES

- Completely automated assembly features extensive use of automatic and robotic equipment to weld and assemble body.
- All body openings, front door frames, window frames, windshield frame, rear door frame and side door frame are of one-piece construction for precise fits and excellent corrosion resistance.
- Concealed front door hinges.
- Concealed hood hinges.
- Flush-mounted glass (except front doors).
- Improved body seals (weatherstrips) body mounted at front and side doors.
- On-line water test to eliminate leaks.

Special attention is given to corrosion prevention during the construction and final finishing of the body. The following body design features occur during the construction of the body:

- Use of special steel (galvanized, zinc iron alloy, zinc coated) for body components especially subject to corrosion.
- All exterior body panels (except roof) are two-side galvanized.
- Use of one-piece outer panels, eliminating exterior joints where corrosion might occur.
- Use of heavy-gage steel for main underbody components.
- One-piece opening frame construction eliminates lap joints and other potential corrosion areas.
- No exposed welds.

After body construction is completed, additional corrosion prevention steps are taken in the final finishing operation.

- The body, doors and hood are thoroughly cleaned through a 7-stage phosphate wash (4 immersion stages, 3 wash stages).
- Next, body, doors and hood are primed by the uni-prime process.
- Sealers are applied to all critical interior/exterior joints.
- The body, doors and hood are painted with base coat/clear coat enamel.
- An anti-chip coating along the lower body sides is added which extends from the rear of the front wheel openings to the rear door openings to prevent stone chipping.
- Hot-wax spray is applied to entire underbody for sound deadening and corrosion resistance.

ASTRO/SAFARI

(Passenger Van)

DIMENSIONS*

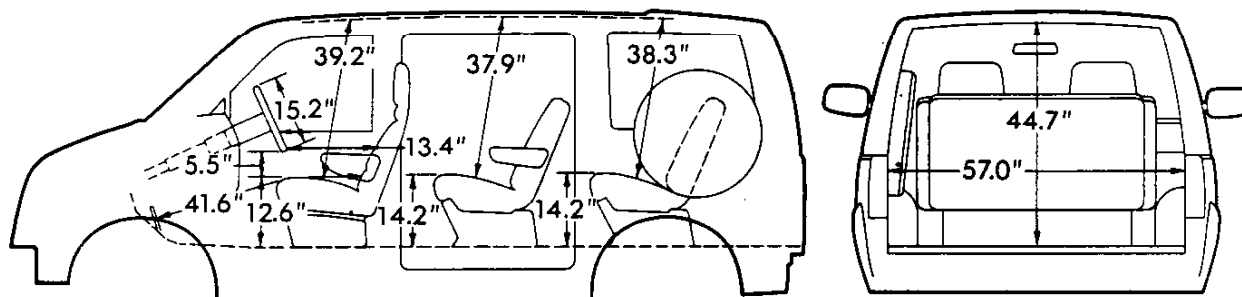

Glass Area (sq in)

Windshield	1858	Rear side windows (each side)	883.5
Front side door window (each side)	532	Rear door windows (total) .	960

*All interior dimensions measured with front seat in rearmost position. Seat travel is 5."

INSTRUMENT CLUSTER

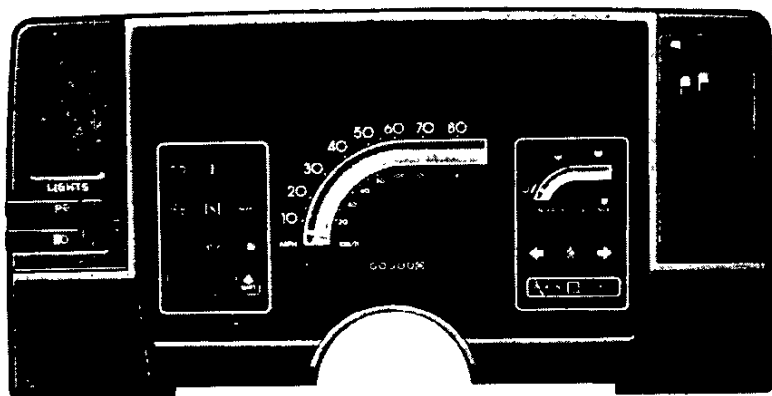

Standard Cluster with warning lights for engine temperature, generator, and oil pressure.

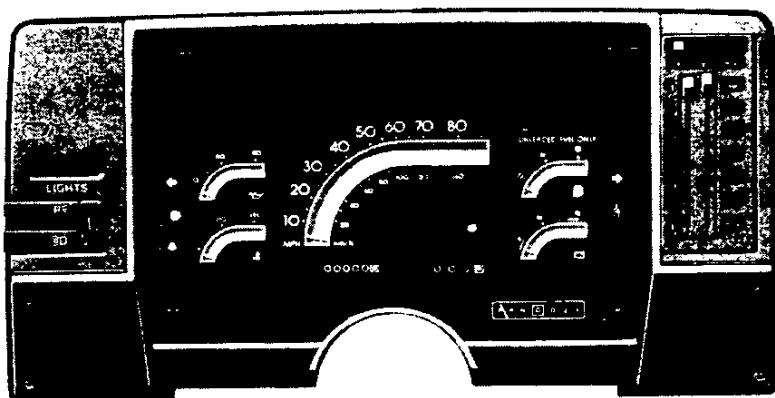

Optional Cluster (RPO Z53) with volt-meter, engine temperature gage, oil pressure gage and trip odometer. Included when Astro CL/Safari SLE or Astro LT/Safari SLT is ordered. Cluster faceplate for standard models has argent finish. When the optional gage cluster is ordered on standard or Astro CL/Safari SLX models, it replaces the respective warning lights and the remaining warning lights are moved to either side as illustrated.

ASTRO/SAFARI

(Passenger Van)

INTERIOR AND EXTERIOR COLOR AVAILABILITY CHART WITHOUT YC7 LUXURY TOURING/GMC TOURING PACKAGE

Please Note: Below are the interior trim color and exterior paint combinations recommended by Chevrolet/GMC. The only available color code 1/color code 2 exterior color combinations are those shown in the chart below, however, any available interior trim color may be ordered with one of these exterior color combinations if that particular combination is desired by the customer.

TRIM LEVEL Seat Type	Decor	INTERIOR COLORS				Color Code 1	Color Code 2	RECOMMENDED INTERIOR TRIM COLORS	Blue/Silver 25A	Gold/Black 53A	Orange/Black 58A	Red/Black 74A	Red/Silver 71A	Tan/Black 63A
		Toal Blue	Burgundy	Saddle Tan	Slate Gray									
STANDARD INTERIOR ASTRO/SAFARI SL Vinyl High Back Bucket Seats Custom Vinyl High Back Bucket Seats Custom Cloth High Back Bucket Seats	Std.	Y004		VSS4										
		XDD4	XEE4	XSS4	XTT4									
		KDD4	KEE4	KSS4	KTT4									
ASTRO CS/SAFARI SLX Vinyl High Back Bucket Seats Custom Vinyl High Back Bucket Seats Custom Cloth High Back Bucket Seats	YC5	Y004		VSS4										
		XDD4	XEE4	XSS4	XTT4									
		KDD4	KEE4	KSS4	KTT4									
ASTRO CL/SAFARI SLE Custom Vinyl High Back Bucket Seats Custom Cloth High Back Bucket Seats	YC6	XDD4	XEE4	XSS4	XTT4									
		KDD4	KEE4	KSS4	KTT4									
ZY1 PAINT OPTIONAL STRIPING CHART RECOMMENDED COMBINATIONS (Requires D85 Body Striping) Additional stripe combinations are available provided the dealer orders (D80) as verification.														
EXTERIOR COLORS w/ZY1 PAINT		Color Code 1	Color Code 2	RECOMMENDED INTERIOR TRIM COLORS				Blue/Silver 25A	Gold/Black 53A	Orange/Black 58A	Red/Black 74A	Red/Silver 71A	Tan/Black 63A	
BLUE, ICED (Metallic)	22	22	X					X						
BLUE, MIDNIGHT (Metallic)	98	98		X			X					X		
BLUE, MIDNIGHT (Metallic)	98	98	X					X						
BLUE, MIDNIGHT (Metallic)	98	98			X				X					
BROWN, DARK (Metallic)	69	69			X				X					
GOLD, CALIFORNIA (Metallic)	52	52			X								X	
GRAY (Metallic)	83	83		X		X						X		
RED, BURNT (Metallic)	77	77		X	X	X						X		
RED, DEEP (Metallic)	75	75		X	X	X						X		
SILVER, STERLING (Metallic)	15	15		X		X					X			
SILVER, STERLING (Metallic)	15	15	X					X						
TAN	60	60		X	X				X					
WHITE, IVORY	10	10			X				X					
WHITE, IVORY	10	10	X					X						
WHITE, IVORY	10	10		X		X					X			
w/ZY3 or ZY7 PAINT														
*STRIPE COLORS (Stripe Colors cannot be changed)														
BLUE, ICED (Met./Blue, Midnight (Met.))	22	98	X					X						
BLUE, ICED (Met./Silver, Sterling (Met.))	22	15	X					X						
BLUE, MIDNIGHT (Met./Gold, California (Met.))	98	52			X								X	
BLUE, MIDNIGHT (Met./Silver, Sterling (Met.))	98	15			X			X						
BROWN, DARK (Met./Silver, Sterling (Met.))	69	15			X					X				
BROWN, DARK (Met./Gold, California (Met.))	69	52			X					X				
GOLD, CALIFORNIA (Met./Blue, Midnight (Met.))	52	98			X						X			
GOLD, CALIFORNIA (Met./Red, Burnt (Met.))	52	77			X						X			
GRAY (Met./Blue, Midnight (Met.))	83	98			X			X						
GRAY (Met./Silver, Sterling (Met.))	83	15			X			X						
RED, BURNT (Met./Gold, California (Met.))	77	52			X								X	
RED, BURNT (Met./Silver, Sterling (Met.))	77	15			X						X			
RED, DEEP (Met./Red, Burnt (Met.))	75	77			X									
RED, DEEP (Met./Gold, California (Met.))	75	52			X						X			
RED, DEEP (Met./Silver, Sterling (Met.))	75	15			X						X			
SILVER, STERLING (Met./Blue, Midnight (Met.))	15	98	X					X						
SILVER, STERLING (Met./Red, Burnt (Met.))	15	77			X							X		
TAN/Blue, Midnight (Met.)	60	98			X				X					
TAN/Red, Burnt (Met.)	60	77			X						X			
TAN/Gold, California (Met.)	60	52			X					X				
WHITE, IVORY/Blue, Midnight (Met.)	10	98	X					X						
WHITE, IVORY/Red, Burnt (Met.)	10	77			X			X				X		
WHITE, IVORY/Gold, California (Met.)	10	52			X					X				
WHITE, IVORY/Silver, Sterling (Met.)	10	15			X			X			X			

WITH YC7 LUXURY TOURING/GMC TOURING PACKAGE

TRIM LEVEL Seat Type	Decor	INTERIOR COLORS		Color Code 1	Color Code 2	RECOMMENDED INTERIOR TRIM COLORS	Stripe	Gold
		Toal Blue	Saddle Tan					
ASTRO/SAFARI LT Velour Cloth Reclining Bucket Seats	YC7	LDD6	LSS6					
EXTERIOR COLORS w/ZY1 PAINT								
BLUE, SAPPHIRE (Metallic)		25	25			X	X	
BROWN, CARAMEL (Metallic)		68	68					X
w/ZY3 PAINT								
BLUE, ICED (Metallic)/Blue, Sapphire (Metallic)		22	25			X		
GOLD, CALIFORNIA (Metallic)/Brown, Caramel (Metallic)		52	68				X	X

*D85 required if stripe is desired w/ZY7 Paint. Stripe is included w/ZY3 Paint.

ASTRO

(Passenger Van)

AVAILABLE WINDOW ARRANGEMENTS

(See Option Section For Restrictions)

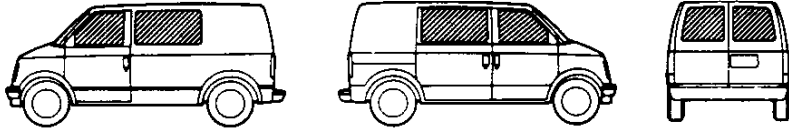

STANDARD
(Includes rear door windows, side sliding door window and LH front quarter window)

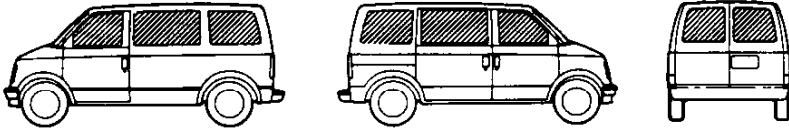

W/ZW6
(Includes RH and LH rear quarter windows)

AVAILABLE SEATING ARRANGEMENTS

(One Seating Arrangement Option Must Be Specified)
(See Option Section For Restrictions)

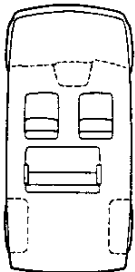

Standard

W/ZP5

Standard 5 person seating without YC7

Includes High Back buckets (2 front) and standard 3-passenger bench seat.

With YC7

Includes reclining bucket seats (2 front) and split back reclining 3-passenger bench seat with folding arm rests.

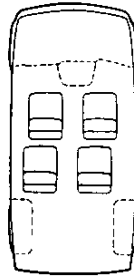

W/ZP4

4 person seating without YC7

Includes 4 High Back buckets (2 front and 2 mid-ship). Not available with standard vinyl trim. Also includes A78 reclining seat backs.

With YC7

Includes reclining bucket seats (2 front and 2 mid-ship).

W/ZP7

7 person seating without YC7

Includes 4 High Back buckets and a 3-passenger bench seat. Requires Custom seat trim and P205 tires (w/o YC5 or YC6 requires P18 Spare Tire Carrier). Also includes A78 reclining seats, N40 Power Steering and F59 Front Stabilizer Bar.

With YC7

Includes 4 reclining bucket seats (2 front and 2 mid-ship) and a split back reclining 3-passenger bench seat with folding armrests. Requires P205 tires. Also includes N40 Power Steering and F59 Front Stabilizer Bar.

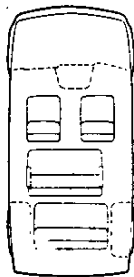
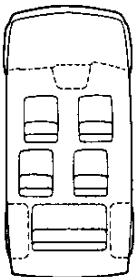

W/ZP8

8 person seating without YC7

Includes 2 High Back buckets and 2 3-passenger bench seats. Requires P205 tires (w/o YC5 or YC6 requires P18 Spare Tire Carrier). Also includes N40 Power Steering and F59 Front Stabilizer Bar.

With YC7

Includes reclining bucket seats and 2 split back reclining 3-passenger bench seats with folding armrests. Also includes N40 Power Steering and F59 Front Stabilizer Bar.

ASTRO/SAFARI SL

(Passenger Van)

SOLID AND TWO-TONE* EXTERIOR COLOR COMBINATIONS

The application of paint for solid and two-tone exterior color combinations is shown below.

SOLID COLOR

Solid paint (ZY1) is standard on all models (except Sport/Gypsy). All painted areas of the body and front end sheet metal including the bumpers, are the same color.

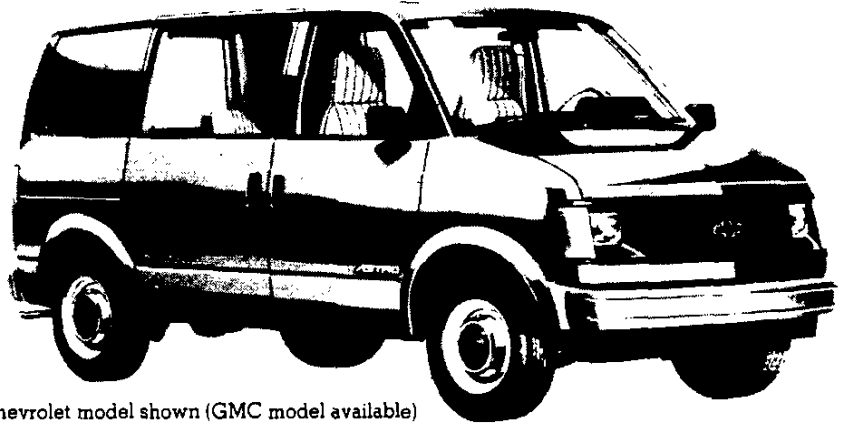

Chevrolet model shown (GMC model available)

SPECIAL TWO-TONE

Special two-tone paint (ZY3), is available on all models and includes a dual color decal stripe located at the belt styling crease line. The areas above the decal are painted color code 1. The areas below the decal, including the bumpers, are painted color code 2.

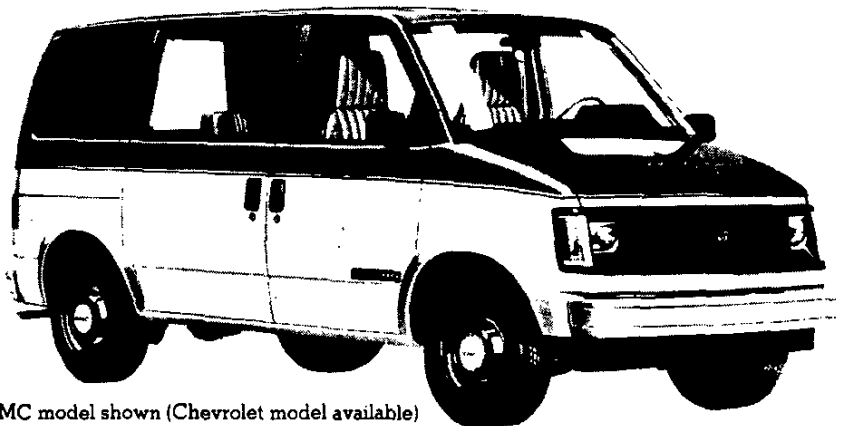

GMC model shown (Chevrolet model available)

SPORT TWO-TONE

Sport two-tone paint (ZY7), which provides a lower accent two-tone scheme, is available on all models. Color code 1 is applied to the areas above the lower styling crease line and color code 2 is applied to the areas below, including the bumpers and fender flares.

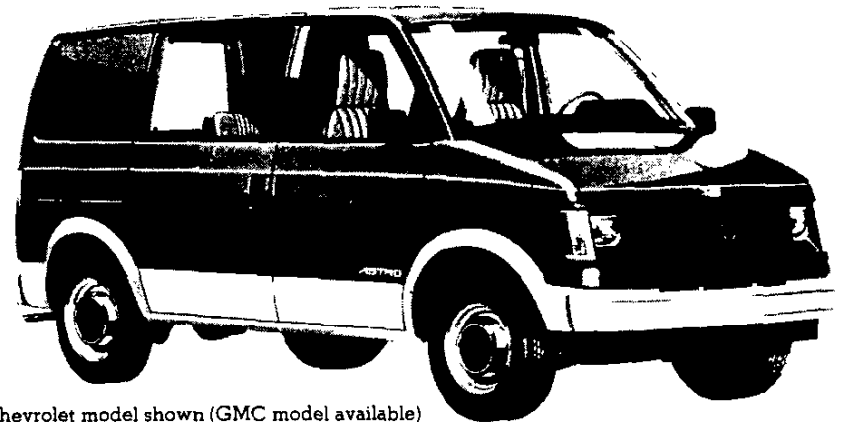

Chevrolet model shown (GMC model available)

*Optional at extra cost

NOTES