

MANUFACTURERS MOTOR VEHICLE SPECIFICATIONS

METRIC (U.S. Customary)

1988

Manufacturer Chevrolet Motor Division General Motors Corporation	Vehicle Line CORSIKA	
	Issued October, 1986	Revised September, 1987

Direct questions concerning these specifications to the manufacturer listed above.

The information contained herein is prepared, distributed by, and is solely the responsibility of the vehicle manufacturing company to whose products it relates. This specification form was developed by the vehicle manufacturing companies under the auspices of the Motor Vehicle Manufacturers Association of the United States, Inc.

The General Specifications herein are those in effect at date of compilation and are subject to change without notice or incurring obligation by the manufacturer.



Motor Vehicle Manufacturers Association
of the United States, Inc.

Blank Forms Provided by Technical Affairs Division

MVMA Specifications Form

METRIC (U.S. Customary)

Table of Contents

1	Vehicle Models	∅ Indicates Format Change From Previous Year
2	Power Teams	
∅ 3-6	Engine	
4	Lubrication System	
4	Diesel Information	
5	Cooling System	
6	Fuel System	
7	Vehicle Emission Control	
7	Exhaust System	
∅ 8-10	Transmission, Axles and Shafts	
11	Suspension-Front and Rear	
12-13	Brakes	
13	Tires and Wheels	
14-15	Steering	
∅ 15-16	Electrical	
∅ 17	Body – Miscellaneous Information	
18	Restraint System	
18	Frame	
18	Glass	
19	Convenience Equipment	
20-22	Vehicle Dimensions	
23	Vehicle Fiducial Marks	
24	Lamps and Headlamps	
25	Vehicle Mass (Weight)	
26	Optional Equipment Differential Mass (Weight)	
27-33	Vehicle Dimensions Definitions - Key Sheets	
∅ 34	Index	

NOTE:

1. This form uses both SI metric units and U.S. Customary units. The metric unit of measure is presented first, and the U.S. Customary unit follows in parentheses.
2. UNLESS OTHERWISE INDICATED:
 - a. Specifications apply to standard models without optional equipment. Significant deviations are noted.
 - b. Nominal design dimensions are used throughout these specifications.
 - c. All linear dimensions are in millimeters (inches), and all mass (weight) specifications are in kilograms (pounds).
3. The General Specifications herein are those in effect at date of compilation and are subject to change without notice or incurring obligation by the manufacturer.
4. Additional Vehicle Dimensions (based in part on SAE J1100 "Motor Vehicle Dimensions") may be available from the manufacturer

MVMA Specifications Form

METRIC (U.S. Customary)

Vehicle Line CORSICA
Model Year 1988 Issued 10-86 Revised (*) 3-87

Vehicle Models

Model Description & Drive (FWD/RWD)	Introduction Date	Make, Vehicle Models, Series, Body Type (Mfg's Model Code)	No. of Designated Seating Positions (Front/Rear)	Max. Trunk/Cargo Load—Kilograms (Pounds)
FRONT WHEEL DRIVE		<u>MODEL NUMBER</u>	<u>FRONT/REAR</u>	
<u>CORSICA</u> 4-Door Notchback Sedan		1TL69	2/3	

MVMA Specifications Form

Vehicle Line CORSICA
 Model Year 1988 Issued 10-86 Revised (*) 9-87

METRIC (U.S. Customary)

Power Teams (Indicate whether standard or optional)

SAE J1349 Net bhp (brake horsepower) and net torque corrected to 77°F/25° C and 29.61 in. Hg/100 kPa atmospheric pressure.

SERIES AVAILABILITY	ENGINE					Exhaust S/D	TRANSMISSION/ TRANSAXLE	Drive Ratios (:1)			
	Displ. Liters (in³)	Carb. (Barrels, FI, etc.)	Compr. Ratio	SAE Net at RPM				Overall Veh. Base Drive	Overall Veh. Opt. Drive	Axle Ratio	
				Power kW (bhp)	Torque N·m (lb. ft.)						
Base - All States	L-4 2.0 Liter + (121 CID) LL8	EFI +	9.0:1	(90 @ 5600)	(108 @ 3200)	S	Man 5-Speed 3.73 Low Base	3.83	2.83	--	--
							Auto '125c' Avail	3.18	3.18\$	--	--
Opt. - All States	V6 2.8 Liter (173 CID) LB6	MFI %	8.9:1	(130 @ 4700)	(160 @ 3600)	S	Man 5-Speed 3.50 Low Base	3.61	2.60	--	--
							Auto '125c'	3.18\$	3.18	--	--
+ - Electronic % - (2.8 Multi \$ - Axle Ratio	Fuel Injection Port FI	= Chain Drive	x Differential Drive Ratio								

MVMA Specifications Form

METRIC (U.S. Customary)

Vehicle Line CORSICA
 Model Year 1988 Issued 10-86 Revised (e) 3-87

Engine Description/Carb.
 Engine Code

2.0 Liter L-4 (121 CID) Electronic Fuel Injection RPO LL8	2.8 Liter V6 (173 CID) (2.8 Multi-Port FI) RPO LB6
---	--

ENGINE - GENERAL

Type & description (inline, V, angle, flat, location, front, mid, rear, transverse, longitudinal, sohc, dohc, ohv, hemi, wedge, pre-camber, etc.)	In line Front Transverse, front of engine faces right side of vehicle	
Manufacturer	Chevrolet	
No. of cylinders	4	6
Bore	89 (3.50)	89 (3.50)
Stroke	80 (3.15)	76 (2.99)
Bore spacing (C / L to C / L)	99 (3.90)	111.8 (4.40)
Cylinder block material & mass kg (lbs.) (machined)	Cast Iron/32.050 (70.7)	Cast Iron/48.2 (106.3)
Cylinder block deck height	215.55 (8.49)	224 (8.819)
Cylinder block length	443 (17.4)	435.5 (17.1)
Deck clearance (minimum) (above or below block)	0.15 (.006) below	0.15 (.006) above
Cylinder head material & mass kg (lbs.)	Aluminum 9.740 (21.5)	Aluminum 5.300 (11.7)
Cylinder head volume (cm ³)	43.3	28.0
Cylinder liner material	Not Available	
Head gasket thickness (compressed)	1.1 (.043)	1.50 (.059)
Minimum combustion chamber total volume (cm ³)	59.988 (3.66)@	59.8481 (3.6515)@
Cyl. no. system (front to rear)*	L. Bank	1-2-3-4
	R. Bank	--
Firing order	1-3-4-2	1-2-3-4-5-6 /2.675 (5.9) Ctr
Intake manifold material & mass (kg (lbs.))**	Aluminum Cast/3.870 (8.5)	Aluminum Cast/3.810 (8.4) Lwr
Exhaust manifold material & mass (kg (lbs.))**	Stamped Steel/2.585 (5.7)	Steel/2.200 (4.9) L.H.
Recommended fuel (leaded, unleaded, diesel)	Unleaded 2.615 (5.8) R.H.	
Fuel antiknock index (R + M) 2	87	
Total dressed engine mass (wt) dry***	146.8 (323.6) Auto 162.4 (358.0) Man	199.7 (440.3) Auto 215.0 (474.0) Man
Engine - Pistons		
Material & mass, g (weight, oz.) - piston only	Aluminum Alloy 350 (12.3)	Aluminum Alloy

Engine - Camshaft

Location	In cylinder block, right side In block above crankshaft	
Material & mass kg (weight, lbs.)	Cast Iron 3.065 (6.8)	Cast Iron/3.098 (6.83)
Drive type	Chain / belt	Chain
	Width / pitch	19.3 (0.76)/9.53 (0.38)

* Rear of engine - drive takeoff. View from drive takeoff end to determine left & right side of engine.
 ** Finished state.
 *** Dressed engine mass (weight) includes the following: All those items necessary to make the engine a complete ready-to-run unit.

@ - Piston at TDC, spark plug and valves in place, and cylinder head torqued to specifications.

MVMA Specifications Form

Vehicle Line CORSICA
 Model Year 1988 Issued 10-86 Revised (e) 3-87

METRIC (U.S. Customary)

Engine Description/Carb.
 Engine Code

2.0 Liter L-4 (121 CID) Electronic Fuel Injection RPO LL8	2.8 Liter V6 (173 CID) (2.8 Multi-Port FI) RPO LB6
---	--

Engine - Valve System

Hydraulic lifters (std., opt., NA)	Standard	
Valves	Number intake / exhaust	4/4
	Head O.D. intake / exhaust	43.00 (1.69)/37.00 (1.46)
		6/6
		43.64 (1.72)/36.20 (1.43)

Engine - Connecting Rods

Material & mass [kg., (weight, lbs.)]*	Cast Steel, .373 (.820)	Cast Steel, .399 (0.880)
--	-------------------------	--------------------------

Engine - Crankshaft

Material & mass [kg., (weight, lbs.)]*	Nod. Cast Iron/13.360(29.5)	Nod. Cast Iron/14.170(31.2)
End thrust taken by bearing (no.)	5	3
Length & number of main bearings	5	4
Seal (material, one, two piece design, etc.)	Front	Silicon, one
	Rear	Silicon, one
		Viton/one piece
		Viton/one piece

Engine - Lubrication System

Normal oil pressure [kPa (psi) at engine rpm]	435-530 (63-77) @ 1200	345-450 (50-65) @ 1200
Type oil intake (floating, stationary)	Stationary	
Oil filter system (full flow, part, other)	Full-flow	
Capacity of c/case, less filter-refill-L (qt.)	3.8 (4.0)	3.8 (4.0)

Engine - Diesel Information

Diesel engine manufacturer		
Glow plug, current drain at 0°F		
Injector nozzle	Type	Not
	Opening pressure [kPa (psi)]	Applicable
Pre-chamber design		
Fuel injection pump	Manufacturer	
	Type	
Fuel injection pump drive (belt, chain, gear)		
Supplementary vacuum source (type)		
Fuel heater (yes/no)		
Water separator, description (std., opt.)		
Turbo manufacturer		
Oil cooler-type (oil to engine coolant; oil to ambient air)		
Oil filter		

Engine - Intake System

Turbo charger - manufacturer	Not
Super charger - manufacturer	Applicable
Charge cooler	

*Finished State

Ø 1988 Format Change

MVMA Specifications Form

Vehicle Line CORSICA
 Model Year 1988 Issued 10-86 Revised (*) 3-87

METRIC (U.S. Customary)

Engine Description/Carb.
 Engine Code

2.0 Liter L4 (121 CID)
 Electronic Fuel Injection
 RPO LL8

Engine - Cooling System

Coolant recovery system (std., opt., n.a.)		Standard																
Coolant fill location (rad., bottle)		Bottle, coolant recovery																
Radiator cap relief valve pressure [kPa (psi)]		103.4 (15)																
Circulation thermostat	Type (choke, bypass)	Choke																
	Starts to open at °C (°F)	91 (195°F)																
Water pump	Type (centrifugal, other)	Centrifugal, with aluminum die cast body																
	GPM 1000 pump rpm	7.3 @ 1000 pump RPM																
	Number of pumps	One																
	Drive (V-belt, other)	V-belt																
	Bearing type	Sealed, ball-roller																
	Impeller material	Cast Iron																
Housing material		Aluminum																
By-pass recirculation [type (inter., ext.)]		Internal																
Cooling system capacity	With heater-L(qt.)	8.19 (8.6) Auto, 8.29 (8.8) Man																
	With air cond.-L(qt.)	8.23 (8.7) Auto, 8.33 (8.8) Man																
	Opt. equipment [specify-L(qt.)]	8.37 (8.8) Auto, 8.37 (8.8) Man																
Water jackets full length of cyl. (yes, no)		Yes																
Water all around cylinder (yes, no)		Yes																
Water jackets open at head face (yes, no)		No																
Radiator core	Std., A/C, HD	Auto	Std.	Auto	A/C	Auto	HD	Auto	AC&HD	Man	Std.	Man	A/C	Man	HD	Man	AC&H	
	Type (cross-flow, etc.)	Cross-flow																
	Construction (fin & tube mechanical, braze, etc.)	High Efficiency Radiator																
	Material, mass [kg (wgt. lbs.)]	Aluminum																
	Width	499.5	659.5	499.5	659.5	499.5	659.5	499.5	659.5	499.5	659.5	499.5	659.5	499.5	659.5	499.5	659.5	
	Height	382.4	382.4	382.4	382.4	382.4	382.4	382.4	382.4	382.4	382.4	382.4	382.4	382.4	382.4	382.4	382.4	
	Thickness	23.5	34.0	23.5	34.0	23.5	34.0	23.5	34.0	23.5	34.0	23.5	34.0	23.5	34.0	23.5	34.0	
	Fins per inch	3.5*	3.5*	3.5*	3.5*	3.5*	3.5*	3.5*	3.5*	3.5*	3.5*	3.5*	3.5*	3.5*	3.5*	3.5*	3.5*	
Radiator end tank material		Plastic																
Std., elec., opt.		Electric																
Fan	Number of blades & type (flex, solid, material)	Std. - 5, flex, plastic (opt. - 7, flex, plastic)																
	Diameter & projected width	Std. - 293.87 (11.57), opt. 360.0 (14.2)																
	Ratio (fan to crankshaft rev.)	Not Applicable																
	Fan cutout type	ECM controlled																
	Drive type (direct, remote)	Direct																
	RPM at idle (elec.)	2200-2400 (constant)																
	Motor rating (wattage) (elec.)	96																
	Motor switch (type & location) (elec.)	Coolant switch, engine cylinder head																
Switch point (temp., pressure) (elec.)	110°F																	
Fan shroud (material)		Plastic																

* - Distance between top of fins.

MVMA Specifications Form

Vehicle Line CORSICA
 Model Year 1988 Issued 10-86 Revised (●) 9-87

METRIC (U.S. Customary)

Engine Description/Carb.
 Engine Code

2.8 Liter V6 (173 CID)
 (2.8 Multi-Port FI)
 RPO LB6

Engine - Cooling System

Coolant recovery system (std., opt., n.a.)	Standard									
Coolant fill location (rad., bottle)	Bottle, coolant recovery									
Radiator cap relief valve pressure [kPa (psi)]	103.4 (15)									
Circulation thermostat	Type (choke, bypass)	Bypass								
	Starts to open at °C (°F)	91 (195°)								
Water pump	Type (centrifugal, other)	Centrifugal, with aluminum die cast body								
	GPM 1000 pump rpm	--								
	Number of pumps	One								
	Drive (V-belt, other)	Serpentine								
	Bearing type	Sealed, ball-roller								
	Impeller material	Cast Iron								
Housing material	Aluminum									
By-pass recirculation [type (inter., ext.)]	Internal									
Cooling system capacity	With heater-L[qt.]	10.71 (11.3) Auto, 10.75 (11.4) Man								
	With air cond.-L[qt.]	10.67 (11.3) Auto, 10.71 (11.3) Man								
	Opt. equipment [specify-L[qt.]]	10.71 (11.3) Auto, 10.71 (11.3) Man								
Water jackets full length of cyl. (yes, no)	Yes									
Water all around cylinder (yes, no)	Yes									
Water jackets open at head face (yes, no)	--									
Radiator core	Std. A/C, HD	Auto Std.	Auto A/C	Auto HD	Auto AC&HD	Man Std	Man A/C	Man HD	Man AC&HD	
	Type (cross-flow, etc.)	Cross-flow								
	Construction (fin & tube mechanical, braze, etc.)	High Efficiency Radiator								
	Material, mass [kg (wt. lbs.)]	Aluminum								
	Width	499.5	659.5	499.5	659.5	499.5	659.5	499.5	659.5	
	Height	382.4	382.4	382.4	382.4	382.4	382.4	382.4	382.4	
	Thickness	23.5	34.0	23.5	34.0	23.5	34.0	23.5	34.0	
	Fins per inch	3.5*	3.5*	3.5*	3.5*	3.5*	3.5*	3.5*	3.5*	
Radiator end tank material	Plastic									
Fan	Std. elec., opt.	Electric								
	Number of blades & type (flex, solid, material)	Std. - 7, flex, plastic (opt. same - 7, flex, plastic)								
	Diameter & projected width	Std. and opt. same - 360.0 (14.2)								
	Ratio (fan to crankshaft rev.)	Not Applicable								
	Fan cutout type	ECM controlled								
	Drive type (direct, remote)	Direct								
	RPM at idle (elec.)	1800								
	Motor rating (wattage) (elec.)	140-150								
	Motor switch (type & location) (elec.)	Coolant switch, engine cylinder head								
	Switch point (temp., pressure) (elec.)	110°F								
Fan shroud (material)	Plastic									

* - Distance between top of fins.

MVMA Specifications Form

Vehicle Line CORSICA
 Model Year 1988 Issued 10-86 Revised (•) 6-87

METRIC (U.S. Customary)

Engine Description/Carb.
 Engine Code

2.0 Liter L-4 (121 CID)
 Electronic Fuel Injection
 RPO LL8

Engine – Fuel System (See supplemental page for details of Fuel Injection, Supercharger, Turbocharger, etc. if used)

Induction type: carburetor, fuel injection system, etc.		Fuel Injection CCC controlled	
Manufacturer		Rochester Products	
Carburetor	Choke (type)	None	
	Idle spd.-rpm (spec. neutral or drive and propane if used)	Manual	Not Applicable
			Not Applicable
		Automatic	Not Applicable
		Not Applicable	
Idle A/F mix.		Preset - no adjustment provided	
Fuel injection	Point of injection (no.)	Throttle body	
	Constant, pulse, flow	Pulse	
	Control (electronic, mech.)	Electronic	
	System pressure [kPa (psi)]	68.95-82.74 (10-12)	
Intake manifold heat control (exhaust or water thermostatic or fixed)		Water	
Air cleaner type	Standard	Replaceable paper element single snorkel	
	Optional	None	
Fuel pump	Type (elec. or mech.)	Electric	
	Location (eng., tank)	Tank	
	Pressure range [kPa (psi)]	Not Applicable	

Fuel Tank

Capacity [refill L (gallons)]		51.5 (13.6)
Location (describe)		Underbody - rear center
Attachment		Underbody strap
Material & Mass [kg (weight lbs)]		Steel 8.732 (19.3)
Filler pipe	Location & material	R.H. rear quarter
	Connection to tank	Solid solder
Fuel line (material)		Steel
Fuel hose (material)		Rubber
Return line (material)		Steel
Vapor line (material)		Steel
Extended range tank	Opt., n.a.	Not Available
	Capacity [L (gallons)]	"
	Location & material	"
	Attachment	"
Auxiliary tank	Opt., n.a.	"
	Capacity [L (gallons)]	"
	Location & material	"
	Attachment	"
	Selector switch or valve	"
	Separate fill	"

MVMA Specifications Form

Vehicle Line CORSICA
 Model Year 1988 Issued 10-86 Revised (e) 6-87

METRIC (U.S. Customary)

Engine Description/Carb.
 Engine Code

2.8 Liter V6 (173 CID)
 (2.8 Multi-Port FI)
 RPO LB6

Engine - Fuel System (See supplemental page for details of Fuel Injection, Supercharger, Turbocharger, etc. if used)

Induction type: carburetor, fuel injection system, etc.		Multi-Port Fuel Injection	
Manufacturer		Rochester Products	
Carburetor	Choke (type)	None	
	Idle spd.-rpm (spec. neutral or drive and propane if used)	Manual	Not Applicable
			Not Applicable
		Automatic	Not Applicable
Idle A/F mix.		Preset - no adjustment provided	
Fuel injection	Point of injection (no.)	Fuel injectors at inlet ports	
	Constant, pulse, flow	Pulse	
	Control (electronic, mech.)	Electronic	
	System pressure (kPa (psi))	Not Available	
Intake manifold heat control (exhaust or water thermostatic or fixed)		Water	
Air cleaner type	Standard	Replaceable paper element single snorkel	
	Optional	None	
Fuel pump	Type (elec. or mech.)	Electric	
	Location (eng., tank)	Tank	
	Pressure range (kPa (psi))	Not Applicable	

Fuel Tank

Capacity (refill L (gallons))		51.5 (13.6)
Location (describe)		Underbody - rear center
Attachment		Underbody strap
Material & Mass (kg (weight lbs))		Steel 8.732 (19.3)
Filler pipe	Location & material	R.H. rear quarter
	Connection to tank	Solid solder
Fuel line (material)		Steel
Fuel hose (material)		Rubber
Return line (material)		Steel
Vapor line (material)		Steel
Extended range tank	Opt., n.a.	Not Available
	Capacity [L (gallons)]	"
	Location & material	"
	Attachment	"
Auxiliary tank	Opt., n.a.	"
	Capacity [L (gallons)]	"
	Location & material	"
	Attachment	"
	Selector switch or valve	"
Separate fill		"

MVMA Specifications Form

Vehicle Line CORSICA
 Model Year 1988 Issued 10-86 Revised (●) 3-87

METRIC (U.S. Customary)

Engine Description/Carb.
 Engine Code

2.0 Liter L-4 (121 CID) Electronic Fuel Injection RPO LL8	2.8 Liter V6 (173 CID) 2.8 Multi-Port FI RPO LB6
---	--

Vehicle Emission Control

Exhaust Emission Control	Type (air injection, engine modifications, other)		CCC control with fuel injection	
	Air injection	Pump or pulse	None	
		Driven by	None	
		Air distribution (head, manifold, etc.)	None	
		Point of entry	None	
	Exhaust Gas Recirculation	Type (controlled flow, open orifice, other)	Controlled flow	
		Exhaust source	Exhaust manifold	
		Point of exhaust injection (spacer, carburetor, manifold, other)	Inlet manifold	
	Catalytic Converter	Type	Single bed, oxidizing & reducing	
		Number of	One	
		Location(s)	Mounted to center underbody	
		Volume [L (in ³)]	2.78 (170)	
		Substrate type	Monolith	
	Crankcase Emission Control	Type (ventilates to atmosphere, induction system, other)		Induction system
Energy source (manifold vacuum, carburetor, other)		Manifold vacuum		
Discharges (to intake manifold, other)		Intake manifold		
Air inlet (breather cap, other)		Air cleaner		
Evaporative Emission Control	Vapor vented to (crankcase, canister, other)	Fuel tank	Canister	
		Carburetor	--	
Vapor storage provision		Canister		
Electronic system	Closed loop (yes/no)		Yes	
	Open loop (yes/no)		No	

Engine - Exhaust System

Type (single, single with cross-over, dual, other)		Single (with dual tailpipes 2-doors only)	
Muffler no. & type (reverse flow, straight thru, separate resonator) Material & Mass [kg (weight lbs)]		One, reverse flow	
Resonator no. & type		None	
Exhaust pipe	Branch o.d., wall thickness	--	
	Main o.d., wall thickness	50.8 x 0.94 (2.0 x .037)*	50.8 x 0.94 (2.0 x .037)
	Material & Mass [kg (weight lbs)]	*	
Inter-mediate pipe	o.d. & wall thickness	50.8 x 1.09 (2.0 x .043)	
	Material & Mass [kg (weight lbs)]	Aluminum coated steel	
Tail pipe	o.d. & wall thickness	50.8 x 1.09 (2.0 x .043)	50.8 x 1.09 (2.0 x .043)
	Material & Mass [kg (weight lbs)]	Aluminum coated steel	

- * - Laminated tubing - steel inner, stainless steel outer.
- ** - Purchased as unit: 9.000 (19.8)

MVMA Specifications Form

METRIC (U.S. Customary)

Vehicle Line CORSICA
 Model Year 1988 Issued 10-86 Revised (•) 3-87

Engine Description/Carb.
 Engine Code

2.0 Liter L4 (121 CID)
 Electronic Fuel Injection
 RPO LL8

Transmissions/Transaxle (Std., Opt., N.A.)

Manual 3-speed (manufacturer/country)	Not Available
Manual 4-speed (manufacturer/country)	" "
Manual 5-speed (manufacturer/country)	Standard
Automatic (manufacturer/country)	Optional
Automatic overdrive (manufacturer/country)	Not Available

Manual Transmission/Transaxle

Number of forward speeds	5	
Gear ratios	1st	3.73
	2nd	2.15
	3rd	1.33
	4th	0.92
	5th	0.74
	Reverse	3.50
Synchronous meshing (specify gears)	All forward gears	
Shift lever location	Floor	
Trans. case mat'l. & mass kg (lbs)*	Aluminum	
Lubricant	Capacity [L (pt.)]	5-speed 2.55L (5.36 pts.)
	Type recommended	SAE 5W-30 Engine oil SF, SF/CC or SF/CD

Clutch (Manual Transmission)

Clutch manufacturer	Isuzu	
Clutch type (dry, wet; single, multiple disc)	Dry disc	
Linkage (hydraulic, cable, rod, lever, other)	Hydraulic	
Max. pedal effort (nom. spring load, new) N (lbs)	Depressed	133.4 (30.0)
	Released	115.6 (26.0)
Assist (spring, power/percent, nominal)	Not Available	
Type pressure plate springs	Diaphragm	
Total spring load (nominal, new) N (lbs)	5391 (1212)	
Clutch facing	Facing mfr. & material coding	Isuzu
	Facing material & construction	Non-asbestos
	Rivets per facing	16
	Outside x inside dia. (nominal)	215.0 x 154.0 (8.46 x 6.06)
	Total eff. area [cm ² (in. ²)]	176.6 (23.37)
	Thickness (pressure plate side/fly wheel side)	7.8 (.307)
	Rivet depth (pressure plate side/fly wheel side)	1.3 mm (0.05 in)/1.2 mm (0.05 in)
	Engagement cushion method	Driven plate, wave spoke springs
Release bearing type & method lub.	Self centering, angular contact ball bearing pre-packed & sealed	
Torsional damping method, springs, hysteresis	Coil springs with non-metal friction control	

* Includes shift linkage, lubricant, and clutch housing. If other specify.

1988 Format Change

MVMA Specifications Form

Vehicle Line CORSICA
 Model Year 1988 Issued 10-86 Revised (e) 3-87

METRIC (U.S. Customary)

Engine Description/Carb.
 Engine Code

2.8 Liter V6 (173 CID)
 Multi-Port FI
 RPO LB6

Transmissions/Transaxle (Std., Opt., N.A.)

Manual 3-speed (manufacturer/country)	Not Available
Manual 4-speed (manufacturer/country)	" "
Manual 5-speed (manufacturer/country)	Standard
Automatic (manufacturer/country)	Optional
Automatic overdrive (manufacturer/country)	Not Available

Manual Transmission/Transaxle

Number of forward speeds		5
Gear ratios	1st	3.50
	2nd	2.05
	3rd	1.38
	4th	0.94
	5th	0.72
	Reverse	3.41
Synchronous meshing (specify gears)		All forward gears
Shift lever location		Floor
Trans. case mat'l. & mass kg (lbs)*		Aluminum
Lubricant	Capacity [L (pt.)]	2.55L (5.36 pts.)
	Type recommended	SAE 5W-30 Engine oil SE, SF/CC or SF/CD

Clutch (Manual Transmission)

Clutch manufacturer		LUK
Clutch type (dry, wet; single, multiple disc)		Dry single disc
Linkage (hydraulic, cable, rod, lever, other)		Hydraulic
Max. pedal effort (nom. spring load, new) N (lbs)	Depressed	133.4 (30.0)
	Released	133.4 (30.0)
Assist (spring, power/percent, nominal)		Not Available
Type pressure plate springs		Diaphragm
Total spring load (nominal, new) N (lbs)		5698 (1281)
Clutch facing	Facing mfr. & material coding	LUK
	Facing material & construction	Non-asbestos
	Rivets per facing	32
	Outside x inside dia. (nominal)	232 x 155 (9.12 x 6.12)
	Total eff. area [cm ² (in. ²)]	232 (35.96)
	Thickness (pressure plate side/fly wheel side)	7.50 - 8.00 (.295 - .315)
	Rivet depth (pressure plate side/fly wheel side)	1.4 mm (0.06 in)/1.4 mm (0.06 in)
	Engagement cushion method	Driven plate, wave spoke springs
Release bearing type & method lub.		Self centering, angular contact ball bearing pre-packed & sealed
Torsional damping method, springs, hysteresis		Coil springs with non-metal friction control

* Includes shift linkage, lubricant, and clutch housing. If other specify.

1988 Format Change

MVMA Specifications Form

METRIC (U.S. Customary)

Vehicle Line CORSICA
 Model Year 1988 Issued 10-86 Revised (●) 3-87

Engine Description/Carb.
 Engine Code

2.0 Liter L-4 (121 CID) Electronic Fuel Injection RPO LL8	2.8 Liter V6 (173 CID) 2.8 Multi-Port FI RPO LB6
---	--

Automatic Transmission/Transaxle

Trade name	3-speed Automatic	
Type and special features (describe)	Torque converter with clutch 125C	
Selector	Location	Floor
	Ltr./No. designation	P-R-N-D-2-1
Gear ratios	1st	2.84
	2nd	1.60
	3rd	1.00*
	4th	Not Applicable
	Reverse	2.07
Max. upshift speed - drive range [km/h (mph)]	1-2=63(39), 2-3=111(69)	1-2=66(41), 2-3=117(73)
Max. kickdown speed - drive range [km/h (mph)]	3-2=100(62), 2-1=58(36)	3-2=111(69), 2-1=58(36)
Min. overdrive speed [km/h (mph)]	Not Available	
Torque converter	Number of elements	3
	Max. ratio at stall	2.7 2.35
	Type of cooling (air, liquid)	Liquid
	Nominal diameter	245 (9.65)
Lubricant	Capacity (refill L (pt.))	5.5L
	Type Recommended	Dexron II
Oil cooler (std., opt., NA, internal, external, air, liquid)	Standard, integral part of radiator	
<input checked="" type="checkbox"/> Transmission case material & mass kg (lbs)*	Aluminum	

Axle or Front Wheel Drive Unit

* - Converter clutch engagement

Type (front, rear)	Front		
Description	Front differential with helical gears and tapered roller bearings		
Limited slip differential (type)	Not Available		
Drive pinion offset	" "		
Drive pinion (type)	" "		
No. of differential pinions	2		
Pinion / differential (shim, other)	None		
Pinion / differential (shim, other)	Shim		
Driving wheel bearing (type)	Sealed ball bearings		
Lubricant	Capacity [L (pt.)]	Part of auto. trans. lub.	
	Type recommended	Transmission lub.	
	SAE viscosity number	Summer	Transmission lub.
		Winter	Transmission lub.
		Extreme cold	Transmission lub.

Axle or Transaxle Ratio and Tooth Combinations (See 'Power Teams' for axle ratio usage.)

Axle ratio (or overall top gear ratio)	3.18	3.61	3.83
No. of teeth	Pinion		
	Ring gear or gear		
Ring gear o.d.	195.2		
Transaxle	Transfer gear ratio	--	
	Final drive ratio	--	

* Includes shift linkage, lubricant, & clutch housing. If other specify.

1988 Format Change

MVMA Specifications Form

Vehicle Line CORSICA
 Model Year 1988 Issued 10-86 Revised (•) 3-87

METRIC (U.S. Customary)

Engine Description/Carb.
 Engine Code

2.0 Liter L-4 (121 CID) Electronic Fuel Injection RPO LL8	2.8 Liter V6 (173 CID) 2.8 Multi-Port FI RPO LB6
---	--

Axle Shafts – Front Wheel Drive

Manufacturer and number used		Two		
Type (straight, solid bar, tubular, etc.)	Left	Straight solid bar		
	Right	Straight solid bar (a)		
Outer diam. x length* x wall thickness	Manual transmission	Left	23.81 x 320.0 (b)	27.05 x 315.5 (c)
		Right	46.5 x 663.0 (b) (a)	27.05 x 315.5 (c)
	Automatic transmission	Left	23.81 x 311.0 (b)	27.05 x 308.0 (c)
		Right	23.81 x 364.3 (b)	27.05 x 357.0 (c)
	Optional transmission	Left	None	
		Right	None	
Slip yoke	Type	None		
	Number of teeth	None		
	Spline o.d.	None		
Universal joints	Make and mfg. no.	Inner	Saginaw	
		Outer	Saginaw	
	Number used	Two on each drive shaft		
	Type, size, plunge	Inner	TRI-POT (d)	
		Outer	Rzeppa - fixed	
	Attach (u-bolt, clamp, etc.)	Splined		
	Bearing	Type (plain, anti-friction)	Anti-friction	
Lubrication (fitting, prepack)		Prepacked		
Drive taken through (torque tube, arms or springs)		Wishbone lower control arm; upper MacPherson strut		
Torque taken through (torque tube, arms or springs)		Engine mounting system		

* Centerline to centerline of universal joints, or to centerline of attachment.

- (a) - Tubular R.H. shaft with LL8 and manual transmission
- (b) - Shaft size = 2300 N.m.
- (c) - Shaft size = 2700 N.m.
- (d) - Plunge = Manual, Left - 24.84mm
 Manual, Right - 33.29mm
 Auto, Left - 24.51mm
 Auto, Right - 25.11mm

- (e) Plunge
 Manual, left = 21.89mm
 Manual, right = 27.59mm
 Auto, left = 22.14mm
 Auto, right = 25.29mm

MVMA Specifications Form

Vehicle Line CORSICA
 Model Year 1988 Issued 10-86 Revised (e) 3-87

METRIC (U.S. Customary)

Body Type And/Or
 Engine Displacement

4-Door Notchback Sedan
 1LT69

Suspension - General

Car leveling	Std./opt./n.a.	Not Available
	Type (air, hyd., etc.)	"
	Manual/auto. controlled	"
Provision for brake dip control		Front suspension geometry
Provision for accel. squat control		Rear suspension geometry
Provisions for car jacking		Body pickup at rocker panels
Shock absorber (front & rear)	Type	MacPherson strut - front; double acting hydraulic - rear
	Make	Delco
	Piston diameter	32.0 (1.26) Front, 25.0 (.98) Rear
	Rod diameter	25.0 (.98) Front, 12.4 (.49) Rear

Suspension - Front

Type and description		MacPherson with coil springs, stamped weldment lower control arms and nodular iron steering knuckles.
Travel	Full jounce	92.5 mm (3.6)
	Full rebound	84.0 mm (3.3)
Spring	Type (coil, leaf, other) & material	Coil, steel
	Insulators (type & material)	Upper and lower, natural rubber
	Size (coil design height & i.d., bar length x dia.)	206.6 (8.1) x 139.0 (5.47) x 2932 (115.4) x 12.9 (.5)
	Spring rate [N/mm (lb./in.)]	16.0 (91.0) Base, 22.0 (126.0) F40 & F41
	Rate at wheel [N/mm (lb./in.)]	17.2 (98.0) Base, 23.2 (132.0) F40 & F41
Stabilizer	Type (link, linkless, frameless)	Link
	Material & bar diameter	Steel, Hollow 26.0 (1.02), 30.0 (1.18) Solid w/F41

Suspension - Rear

Type and description		Trailing arm with tubular control arms and open section transverse beam.
Travel	Full jounce	105.0 (4.13)
	Full rebound	96.0 (3.78)
Spring	Type (coil, leaf, other) & material	Progressive rate coil, HR steel
	Size (length x width, coil design height & i.d., bar length & dia.)	290 (11.42) x 105 (4.13) x 2626 (103.4) x 13.6 (.54)
	Spring rate [N/mm (lb./in.)]	23 (131) Base, F40 & F41 - 28 (160)
	Rate at wheel [N/mm (lb./in.)]	14.6 (83) Base, F40 & F41 - 16.7 (95)
	Insulators (type & material)	Rubber - top & bottom
	If leaf	No. of leaves Shackle (comp. or tens.)
Stabilizer	Type (link, linkless, frameless)	None on base 1-4. Linkless with V6 or F41
	Material & bar diameter	Steel, 15mm (.59) Solid w/V6, 19mm (.79) Solid w/F41
Track bar (type)		Not Applicable

MVMA Specifications Form

METRIC (U.S. Customary)

Vehicle Line CORSICA
 Model Year 1988 Issued 10-86 Revised (●) 6-87

Body Type And/Or
 Engine Displacement

4-Door Notchback Sedan
 1LT69

Brakes - Service

Description		Single caliper disc front, leading trailing drum rear			
Manufacturer and brake type (std., opt., n.a.)	Front (disc or drum)	Disc			
	Rear (disc or drum)	Drum			
Self-adjusting (std., opt., n.a.)		Standard			
Special valving	Type (proportion, delay, metering, other)	Proportioning, Diagonal split circuit			
Power brake (std., opt., n.a.)		Standard			
Booster type (remote, integral, vac., hyd., etc.)		Tandem vacuum			
Vacuum source (inline, pump, etc.)		Inline (intake manifold)			
Vacuum reservoir (volume in. ³)		None			
Vacuum pump-type (elec. gear driven, belt driven, if other so state)		"			
Anti-lock device type (std., opt., n.a.) (F/R)		Not Available			
Effective area [cm ² (in. ²)]*		309 (47.9)			
Gross lining area [cm ² (in. ²)]**(F/R)		381 (59.1)			
Swept area [cm ² (in. ²)]**(F/R)		1624 (251.8)			
Rotor	Outerworking diameter	F R	247 (9.72) / --		
	Inner working diameter	F R	147 (5.80)		
	Thickness	F R	22.4 (0.88) / --		
	Material & type (vented solid)	F R	Cast iron, vented / --		
Drum	Diameter & width	F R	-- / 200 x 45 (7.87 x 1.77)		
	Type and material	F R	-- / Cast iron, non-finned		
Wheel cylinder bore		57 (2.24) / 16 (.63)			
Master cylinder	Bore stroke	F R	24 (.94) / 35.59 (1.40)		
Pedal arc ratio		3.7:1			
Line pressure at 445 N(100 lb.) pedal load [kPa (psi)]		Not Available			
Lining clearance		F/R	Self adjusting		
Brake lining	Front wheel	Bonded or riveted (rivets seg.)		In-board, outboard-integrally molded	
		Rivet size		Not Applicable	
		Manufacturer		Delco Moraine	
		Lining code*****		128 FE	
		Material		Semi-metallic	
		****	Primary or out-board	116.7 x 54.7 x 10.92 (4.594 x 2.157 x .430)	
		Size	Secondary or in-board	125 x 59 x 10.2 (4.92 x 2.32 x 0.4)	
	Shoe thickness (no lining)		4.72 IB, 3.14 OB (.186 IB, 0.123 OB)		
	Rear wheel	Bonded or riveted (rivets-seg.)		Riveted, (8)	
		Manufacturer		Inland Division	
		Lining Code*****		235 FE	
		Material		Organic	
		****	Primary or out-board	168.3 X 43.9 X 3.8 (6.62 X 1.73 X .15)	
		Size	Secondary or in-board	199.8 x 43.9 x 4.8 (7.86 x 1.73 x .19)	
Shoe thickness (no lining)		1.98 (.07)			

*Excludes rivet holes, grooves, chamfers, etc.

**Includes rivet holes, grooves, chamfers, etc.

***Total swept area for four brakes. (Drum brake: Widest lining contact width for each brake x its contact circumference.) (Disc brake: Square of Outer Working Dia. minus Square of inner Working Dia. multiplied by Pi 2 for each brake.)

****Size for drum brakes includes length x width x thickness.

*****Manufacturer I.D., catalog or formulation designation and coefficient of friction classification.

MVMA Specifications Form

METRIC (U.S. Customary)

Vehicle Line CORSICA
 Model Year 1988 Issued 10-86 Revised (e) 3-87

Body Type And/Or
 Engine Displacement

4-Door Notchback Sedan
 1LT69

Tires And Wheels (Standard)

Tires	Size (load range, ply)		P185/80R 13 BW
	Type (bias, radial, steel, nylon, etc.)		Steel Belted Radial
	Inflation pressure (cold) for recommended max. vehicle load	Front (kPa (psi))	240 (35)
		Rear (kPa (psi))	240 (35)
Rev./mile—at 70 km/h (45 mph)			
Wheels	Type & material		Steel
	Rim (size & flange type)		13 x 5.5
	Wheel offset		48.0 (1.89)
	Attachment	Type (bolt or stud)	Stud
		Circle diameter	100.0 (3.94)
Number & size		5-M12 x 1.5 - 6H, THD. (metric)	
Spare	Tire and wheel (same size, if other describe)		T115/70D - 14 BW, Wheel dia. 14 x 4. Inflation 415 (60)
	Storage position & location (describe)		Flat under rear load floor

Tires And Wheels (Optional)

Tire size (load range, ply)	P195/70R-14 BW & WW
Type (bias, radial, steel, nylon, etc.)	Steel Belted Radial
Wheel (type & material)	Steel
Rim (size, flange type and offset)	14 x 6
Tire size (load range, ply)	P195/70R-14 BW & WW
Type (bias, radial, steel, nylon, etc.)	Steel Belted Radial
Wheel (type & material)	Aluminum
Rim (size, flange type and offset)	14 x 6
Tire size (load range, ply)	P205/60R-15
Type (bias, radial, steel, nylon, etc.)	Steel Belted Radial
Wheel (type & material)	Steel
Rim (size, flange type and offset)	15 x 6
Tire size (load range, ply)	
Type (bias, radial, steel, nylon, etc.)	
Wheel (type & material)	
Rim (size, flange type and offset)	
Spare tire and wheel (size)	
(if configuration is different than road tire or wheel, describe optional spare tire and/or wheel location & storage position)	

Brakes - Parking

Type of control		Hand Lever Assembly
Location of control		In console between front seats
Operates on		Rear service brakes
If separate from service brakes	Type (internal or external)	--
	Drum diameter	--
	Lining size (length x width x thickness)	--

MVMA Specifications Form

Vehicle Line CORSICA
 Model Year 1988 Issued 10-86 Revised (●) 9-87

METRIC (U.S. Customary)

Body Type And/Or
 Engine Displacement

4-Door Notchback Sedan
 1LT69

Steering

Manual (std., opt., n.a.)		Not Available		
Power (std., opt., n.a.)		Standard		
Adjustable steering wheel/column (tilt, telescope, other)	Type	Tilt		
	Manufacturer	Saginaw Steering Gear		
	(Std., opt., n.a.)	Optional		
Wheel diameter** (W9) SAE J1100	Manual	--		
	Power	378-381mm (14.88 - 15.00 in.)		
Turning diameter m (ft.)	Outside front	Wall to wall (l. & r.)	11.75mm (38.67 ft.) Left, 11.50mm (37.87 ft.) Right	
		Curb to curb (l. & r.)	11.10mm (36.50 ft.) Left, 10.81mm (35.54 ft.) Right	
	Inside rear	Wall to wall (l. & r.)	6.56mm (21.45 ft.) Left, 6.17mm (20.28 ft.) Right	
		Curb to curb (l. & r.)	6.59mm (21.75 ft.) Left, 6.24mm (20.56 ft.) Right	
Scrub Radius*		--		
Manual	Gear	Type	Not Available	
		Manufacturer	--	
		Ratios	Gear	--
			Overall	--
	No. wheel turns (stop to stop)		--	
Power	Type (coaxial, linkage, etc.)		Rack and pinion w/center take-off tie rods - integral	
	Manufacturer		Saginaw Steering Gear Div. G.M.C.	
	Gear	Type	Rack and pinion w/center take-off tie rods - integral	
		Ratios	Gear	Not Applicable
			Overall	16.12:1 (On Center)
	Pump (drive)		Belt off crankshaft pulley	
No. wheel turns (stop to stop)		2.88	F41 2.50	
Linkage	Type		Center take off tie rods, rack and pinion	
	Location (front or rear of wheels, other)		Rear	
	Tie rods (one or two)		Two	
Steering axis	Inclination at camber (deg.)		14° at +0.5°	
	Bearings (type)	Upper	Strut mount	
		Lower	Ball joint	
		Thrust	Not Applicable	
Steering spindle & joint type		"		
Wheel spindle/hub	Diameter	Inner bearing	"	
		Outer bearing	"	
	Thread (size)		M20 x 1.5	
	Bearing (type)		Integral double row ball, permanently lubricated	

*The horizontal distance in the front elevation between wheel centerline and kingpin (ball joint) axis at ground.

**See Page 21.

MVMA Specifications Form

METRIC (U.S. Customary)

Vehicle Line CORSICA
 Model Year 1988 Issued 10-86 Revised (e) 3-87

Body Type And/Or
 Engine Displacement

4-Door Notchback Sedan
 1LT69

Wheel Alignment

Front wheel at curb mass (wt.)	Service checking	Caster (deg.)	Not adjustable
		Camber (deg.)	+ .85° +/- .65°
		Toe-in (outside track-mm (in.))	0° +/- .10°
	Service reset*	Caster	Not adjustable
		Camber	+ .85° +/- .65°
		Toe-in	0° +/- .10°
	Periodic M.V. inspection	Caster	Not adjustable
		Camber	--
		Toe-in	--
Rear wheel at curb mass (wt.)	Service checking	Camber (deg.)	Not Applicable
		Toe-in (outside track-mm (in.))	"
	Service reset*	Camber	"
		Toe-in	"
	Periodic M.V. inspection	Camber	"
		Toe-in	"

* Indicates pre-set, adjustable, trend set or other.

Electrical - Instruments and Equipment

Base Cluster

Opt. Gage Cluster

Speedometer	Type (analog, digital, std., opt.)	Half circle electric analog dial w/pointer	
	Trip odometer (std., opt., n.a.)	Not Available	Standard
EGR maintenance indicator		Not Available	Not Available
Charge indicator	Type	Tell-Tale Warning Light	Gage
	Warning device (light, audible)	Inherent	Not Available
Temperature indicator	Type	Tell-Tale Warning Light	Gage
	Warning device (light, audible)	Inherent	Not Available
Oil pressure indicator	Type	Tell-Tale Warning Light	Gage
	Warning device (light, audible)	Inherent	Not Available
Fuel indicator	Type	Electric gauge w/ pointer	Gage
	Warning device (light, audible)	Not Available	Not Available
Windshield wiper	Type (standard)	Electric 2-speed	
	Type (optional)	Intermittent windshield wiper system	
	Blade length	482.6 (19.0)	
	Swept area [cm ² (in. ²)]	6228.6 (965.4)	
Windshield washer	Type (standard)	Wet-Arm System, rotary switch on RH instrument cluster pod	
	Type (optional)	Not Available	
	Fluid level indicator (light, audible)	" "	
Rear window wiper, wiper/washer (std., opt., n.a.)		" "	
Horn	Type	Vibrator	
	Number used	One ('F' note) ('A' note optional in addition)	
Other	Headlamp-on Warning	Standard, Chimes	

MVMA Specifications Form

Vehicle Line CORSICA
 Model Year 1988 Issued 10-86 Revised (•) 3-87

METRIC (U.S. Customary)

Engine Description/Carb.
 Engine Code

2.0 Liter L-4 (121 CID) Electronic Fuel Injection RPO LL8	2.8 Liter V6 (173 CID) 2.8 Multi-Port FI RPO LB6
---	--

Electrical - Supply System

Battery	Manufacturer	Delco Remy
	Model, std., (opt.)	75-525, 75-630 H.D.
	Voltage	12 Volt
	Amps at 0°F cold crank	525, 630 H.D.
	Minutes-reserve capacity	75 minutes base, 90 minutes H.D.
	Amp/hrs. - 20 hr. rate	--
	Location	Engine compartment
Alternator	Manufacturer	Delco Remy
	Rating (idle/max. rpm)	Diode rectified, 42 amps
	Ratio (alt. crank/rev.)	2.3:1
	Output at idle (rpm, park)	
Regulator	Optional (type & rating)	None
	Type	Integral with Alternator

Electrical - Starting System

Start, motor	Current drain at 0°F -20°F	305 @ -20°F
Motor drive	Engagement type	Solenoid
	Pinion engages from (front, rear)	Front

Electrical - Ignition System

Type	Electronic (std., opt., n.a.)	--	
	Other (specify)	Computer controlled - coil ignition (C ³ I)	
Coil	Make	Delco Remy	
	Model	1115461	
	Current	Engine stopped - A	Not Available
		Engine idling - A	" "
Spark plug	Make	AC spark plug	
	Model	FR3LM R43CTLSE	
	Thread (mm)	M14 x 1.25	
	Tightening torque (N•m (lb. ft))	9-20 (7-15)	
	Gap	0.89 (.035) 1.14 (.045)	
Distributor	Number per cylinder	One	
	Make	Not Applicable	
	Model	" "	

Electrical - Suppression

Locations & type	Internal alternator capacitor, non-metallic high-tension ignition cables, resistor spark plugs, ignition coil by-pass capacitor, internal AC blower motor by-pass capacitor & A/C compression diode, with radio provisions; hood grounding clip, engine to dash panel ground strap, fuse block capacitor and on "heater only" blower motors and coax capacitor.
------------------	---

Ø 1988 Format Change

MVMA Specifications Form

METRIC (U.S. Customary)

Vehicle Line CORSICA
 Model Year 1988 Issued 10-86 Revised (e) 3-87

Body Type

4-Door Notchback Coupe
 1LT69

Body

Structure	Unitized body construction including front end structure with bolted-on fenders and hood.
Bumper system front - rear	Bumper fascias are attached to steel impact bar and dual enersorbers for collision energy absorption. (Meets G.M. 5 mph impact standard).
Anti-corrosion treatment	Special anticorrosion materials are used on interior and exterior metal panel surfaces. Materials include one and two-sided galvanized, ELPO coatings, primers, protective waxes and sealers are used on interior surfaces.

Body - Miscellaneous Information

Type of finish (lacquer, enamel, other)	High solids basecoat/clearcoat enamel	
Hood	Hinge location (front, rear)	Rear
	Type (counterbalance, prop)	Prop
	Release control (internal, external)	Internal
Trunk lid	Type (counterbalance, other)	Torsion rods
	Internal release control (elec., mech., n.a.)	Electrical-Optional
Hatch-back lid	Type (counterbalance, other)	--
	Internal release control (elec., mech., n.a.)	--
Tailgate	Type (drop, lift, door)	--
	Internal release control (elec., mech., n.a.)	
Vent window control (crank, friction, pivot, power)	Front	None
	Rear	"
Seat cushion type (e.g., 60/40, bucket, bench, wire, foam etc.)	Front	Bucket with polyurethane padding
	Rear	Bench with polyurethane padding
	3rd seat	--
Seat back type (e.g., 60/40, bucket, bench, wire, foam etc.)	Front	Reclining bucket with polyurethane padding
	Rear	Fixed bench with polyurethane padding
	3rd seat	--

Ø 1988 Format Change

MVMA Specifications Form
METRIC (U.S. Customary)

Vehicle Line CORSICA
 Model Year 1988 Issued 10-86 Revised (•) 3-87

Body Type

4-Door Notchback Sedan
1LT69

Restraint System

Active restraint system	Standard/optional	Standard
	Type and description	Front-Seat blt & shoulder blt sys with single retractor (2) Rear-Seat blt and shoulder blt sys at otr. positions (2)*
	Location	Front belts attached to rocker panel with inertia reel in lower lock pillar. Frt hkle attached to underbody.**
Passive seat belts	Standard/optional	Not Available
	Power/manual	"
	2 or 3 point	"
	Knee bar/lap belt	"

Frame

Type and description (separate frame, unitized frame, partially-unitized frame)	Body-frame integral with bolt-on power train cradle	
Glass	SAE Ref. No.	
Windshield glass exposed surface area [cm ² (in. ²)]	S1	
Side glass exposed surface area [cm ² (in. ²)] - total 2-sides	S2	
Backlight glass exposed surface area [cm ² (in. ²)]	S3	
Total glass exposed surface area [cm ² (in. ²)]	S4	
Windshield glass (type)		
Side glass (type)		
Backlight glass (type)		

* Rear seat lap belt system at center position (1).
 ** Rear belts attached to underbody and rear package shelf.

MVMA Specifications Form
METRIC (U.S. Customary)

Vehicle Line CORSICA
 Model Year 1988 Issued 10-86 Revised (e) 3-87

Body Type

4-Door Notchback Sedan
 1LT69

Convenience Equipment (standard, optional, n.a.)

Air conditioning (manual, auto. temp control)	Optional (manual control)	
Clock (digital, analog)	Digital (integ. w/stereo radios)	
Compass / thermometer	Not Available	
Console (floor, overhead)	Optional, full floor	
Defroster, elec. backlight	Optional	
Electronic	Diagnostic monitor (integrated, individual)	Not Available
	Instrument cluster (list instruments)	"
	Keyless entry	"
	Tripminder (avg. spd., fuel)	"
	Voice alert (list items)	"
	Other	"
Fuel door lock (remote, key, electric)	Not Available	
Lamps	Auto head on / off delay, dimming	"
	Cornering	"
	Courtesy (map, reading)	*
	Door lock, ignition	Not Available
	Engine compartment	*
	Fog	Not Available
	Glove compartment	Not Available
	Trunk	*
	Other	Ash tray lamp standard
Mirrors	Day night (auto. man)	Standard (manual)
	L.H. (remote, power, heated)	Standard (remote)
	R. H. (convex, remote, power, heated)	Standard (manual convex)
	Visor vanity (RH - LH, illuminated)	Visor Mirror R.H. **
Parking brake-auto release (warning light)	Standard (manual release) lower area of speedometer	
Power equipment	Door locks deck lid - specify	Optional - both
	Seat (2-4-6 way) heated (driver, pass, other) lumbar, hip, thigh support (power, manual) reclining (driver, pass) memory (1-2 preset, recline)	Not Available
	Side windows	Optional
	Vent windows	--
	Rear window	--
Radio systems	Antenna (location, whip, w shield, power)	Front fender-R.H., fixed mast standard
	AM, FM, stereo, tape, CB	AM standard, stereo optional
	Speaker (number, location) Premium sound	2-Standard, I.P., ext. range dual rear included w/stereo
Roof open air (fixed, flip-up, sliding, "T")	Not Available	
Speed control device	Optional	
Speed warning device (light, buzzer, etc.)	Not Available	
Tachometer (rpm)	Optional @	
Telephone system - mobile	Not Available	

Theft protection-type Auto. Trans.-Lock mounted on steering column; locks steering wheel, Auto. Trans. shift lever and ignition. Manual Trans.-Lock mounted on strg. column; locks strg wheel and ignition. Plus: Anti-theft design door lock buttons.

*-Avail in optional lighting package (TR9).
 **-Avail in optional custom interior (B18)

MVMA-C-88 (U21) Avail. together with voltemeter, temp. and oil pressure gauges and trip odometer

MVMA Specifications Form

Vehicle Line CORSICA
 Model Year 1988 Issued 10-86 Revised (•) 6-87

METRIC (U.S. Customary)

Vehicle Dimensions See Key Sheets for definitions

All dimensions to ground are for comparative purposes only. Dimensions are to be shown for all base body models of each vehicle line. SAE Ref. no. refers to the definition published in SAE Recommended Practice J1100 "Motor Vehicle Dimensions," unless otherwise specified.

Body Type	SAE Ref. No.	4-Door Notchback Sedan 1LT69
------------------	---------------------	---------------------------------

Width

Tread (front)	W101	1413 (55.6)
Trear (rear)	W102	1404 (55.3)
Vehicle width	W103	1733 (68.2)
Body width at Sg RP (front)	W117	1726 (68.0)
Vehicle width (front doors open)	W120	3314 (130.5)
Vehicle width (rear doors open)	W121	3404 (134.0)
Front fender overall width	W106	1698 (66.9)
Rear fender overall width	W107	1664 (65.5)
Tumble-home (deg.)	W122	24.0

Length

Wheelbase	L101	2627 (103.4)
Vehicle length	L103	4659 (183.4)
Overhang (front)	L104	975 (38.4)
Overhang (rear)	L105	1057 (41.6)
Upper structure length	L123	2656 (104.6)
Rear wheel C.L. "X" coordinate	L127	2410 (94.9)
Cowl point "X" coordinate	L125	136 (5.4)
Front end length at centerline	L126	1326 (52.2)
Rear end length at centerline	L129	563 (22.2)

Height*

Passenger distribution (front rear)	PD1.2.3	
Trunk cargo load		
Vehicle height	H101	1428 (56.2)
Cowl point to ground	H114	951 (37.4)
Deck point to ground	H138	1053 (41.5)
Rocker panel-front to ground	H112	221 (8.7)
Bottom of door closed-front to grd.	H133	267 (10.5)
Rocker panel-rear to ground	H111	220 (8.7)
Bottom of door closed-rear to grd.	H135	268 (10.6)
Windshield slope angle	H122	60.5
Backlight slope angle	H121	60.5

Ground Clearance*

Front bumper to ground	H102	322 (12.7)
Rear bumper to ground	H104	354 (13.9)
Bumper to ground (front at curb mass (wt.))	H103	336 (13.2)
Bumper to ground (rear at curb mass (wt.))	H105	396 (15.6)
Angle of approach (degrees)	H106	-14.3°
Angle of departure (degrees)	H107	18.7°
Ramp breakover angle (degrees)	H147	5.8°
Axle differential to ground (front-rear)	H153	Not Available
Min. running ground clearance	H156	149 (5.9)
Location of min. run. grd. clear.		

* All vehicle height and ground clearances are measured at the Manufacturer's Design Load Weight. Manufacturer's Design Load Weight is defined with indicated passenger distribution and trunk/cargo load, unless otherwise specified. All linear dimensions are in millimeters (inches) unless otherwise noted.

MVMA Specifications Form

METRIC (U.S. Customary)

Vehicle Dimensions See Key Sheets for definitions

Vehicle Line CORSICA
 Model Year 1988 Issued 10-86 Revised (e) 9-87

Body Type

SAE Ref. No.	4-Door Notchback Sedan 1LT69
--------------	---------------------------------

Front Compartment

Sg RP front, "X" coordinate	L31	1138 (44.8)
Effective head room	H61	968 (38.1)
Max. eff. leg room (accelerator)	L34	1103 (43.4)
SgRP to heel point	H30	248 (9.8)
SgRP to heel point	L53	909 (35.8)
Back angle	L40	26.5
Hip angle	L42	103.5
Knee angle	L44	137.0
Foot angle	L46	87.0
Design H-point front travel	L17	224 (8.8)
Normal driving & riding seat track trvl.	L23	200 (7.9)
Shoulder room	W3	1408 (55.4)
Hip room	W5	1294 (50.9)
Upper body opening to ground	H50	935 (36.8)
Steering wheel maximum diameter*	W9	382 (15.0)
Steering wheel angle	H18	18.5
Accel. heel pt. to steer. whl. cntr	L11	Not Available
Accel. heel pt. to steer. whl. cntr	H17	" "
Steering wheel to C / L of thigh	H13	116 (4.6)
Steering wheel torso clearance	L7	366 (14.4)
Headlining to roof panel (front)	H37	22 (0.9)
Undepressed floor covering thickness	H67	14 (0.6)

Rear Compartment

Sg RP Point couple distance	L50	787 (31.0)
Effective head room	H63	950 (37.4)
Min. effective leg room	L51	890 (35.0)
Sg RP (second to heel)	H31	265 (10.4)
Knee clearance	L48	22 (0.9)
Compartment room	L3	640 (25.2)
Shoulder room	W4	1412 (55.6)
Hip room	W6	1300 (51.2)
Upper body opening to ground	H51	807 (31.8)
Back angle	L41	24.5
Hip angle	L43	88.0
Knee angle	L45	88.0
Foot angle	L47	122.5
Headlining to roof panel (second)	H38	27 (1.1)
Depressed floor covering thickness	H73	20 (0.8)

Luggage Compartment

Usable luggage capacity [L. (cu. ft.)]	V1	382.6 (13.51)
Liftover height	H195	887 (34.9)

Interior Volumes (EPA Classification)

Vehicle class (subcompact, compact, etc.)		Compact
Interior volume index (cu. ft.)		108.6
Trunk/cargo index (cu. ft.)		13.5

* See page 14.

MVMA Specifications Form

METRIC (U.S. Customary)

Vehicle Dimensions See Key Sheets for definitions

Vehicle Line CORSICA
 Model Year 1988 Issued 10-86 Revised (e) 3-87

Body Type	SAE Ref. No.	4-Door Notchback Sedan 1LT69
------------------	---------------------	---------------------------------

Station Wagon – Third Seat

Sg RP couple distance	L85	Not
Shoulder room	W85	Applicable
Hip room	W86	
Effective leg room	L86	
Effective head room	H86	
Sg RP to heel point	H87	
Knee clearance	L87	
Seat facing direction	SD1	
Back angle	L88	
Hip angle	L89	
Knee angle	L90	
Foot angle	L91	

Station Wagon – Cargo Space

Cargo length (open front)	L200	Not
Cargo length (open second)	L201	Applicable
Cargo length (closed front)	L202	
Cargo length (closed second)	L203	
Cargo length at belt (front)	L204	
Cargo length at belt (second)	L205	
Cargo width (wheelhouse)	W201	
Rear opening width at floor	W203	
Opening width at belt	W204	
Min. rear opening width above belt	W205	
Cargo height	H201	
Rear opening height	H202	
Tailgate to ground height	H250	
Front seat back to load floor height	H197	
Cargo volume index [m ³ (ft. ³)]	V2	
Hidden cargo volume [m ³ (ft. ³)]	V4	
Cargo volume index-rear of 2-seat	V10	

Hatchback – Cargo Space

Cargo length at front seatback height	L208	Not
Cargo length at floor (front)	L209	Applicable
Cargo length at second seatback height	L210	
Cargo length at floor (second)	L211	
Front seatback to load floor height	H197	
Second seatback to load floor height	H198	
Cargo volume index [m ³ (ft. ³)]	V3	
Hidden cargo volume [m ³ (ft. ³)]	V4	
Cargo volume index-rear of 2-seat	V11	

Aerodynamics*

Wheel lip to ground, front	Not Available
Wheel lip to ground, rear	" "
Frontal area [m ² (ft ²)]	1.99 (21.4)
Drag coefficient (Cd)	Not Available

* EPA Loaded Vehicle Weight, Loading Conditions

MVMA Specifications Form
METRIC (U.S. Customary)

Vehicle Line CORSICA
 Model Year 1988 Issued 10-86 Revised (e) 3-87

Body Type

4-Door Notchback Sedan
 1LT69

Vehicle Fiducial Marks

Fiducial Mark Number*	Define Coordinate Location
Front	X - Fiducial mark to vertical base grid line - front measured horizontally, from the base grid line to the front fiducial mark located on top of the front seat adjuster mounting bolt.
	Y - Fiducial mark to centerline of car - front, width measurement made from centerline car to fiducial mark located on top of the front seat adjuster mounting bolt.
	Z - Fiducial mark to horizontal base grid line - front, measured vertically from base grid line to front fiducial mark located on top of the front seat adjuster mounting bolt.
Rear	X - Fiducial mark to vertical base grid line - rear, measured horizontally from the base grid line to rear fiducial mark located on the rail (compartment pan - longitudinal).
	Y - Fiducial mark to centerline of car - rear, width measurement made from centerline of car to fiducial mark located on the rail (compartment pan - longitudinal).
	Z - Fiducial mark to horizontal base grid line - rear, measured vertically from the base grid line to rear fiducial mark located on the rail (compartment pan - longitudinal).
Front	W21* 346 (13.6)
	L54* 2760 (108.7)
	H81* 201 (7.9)
	H161* Not Available
	H163* " "
Rear	W22* 440 (17.3)
	L55* 4953 (195.0)
	H82* 362 (14.3)
	H162* Not Available
	H164* " "

* Reference - SAE Recommended Practice, J182, Motor Vehicle Fiducial Marks.

MVMA Specifications Form
METRIC (U.S. Customary)

Vehicle Line CORSICA
 Model Year 1988 Issued 10-86 Revised (*) 3-87

Body Type

4-Door Notchback Sedan
 1LT69

Lamps and Headlamp Shape*

Height above ground to center of bulb or marker	Headlamp (SAE - H127)	Highest**	606.14 (23.9)	
		Lowest	606.14 (23.9)	
	Taillamp (SAE - H128)	Highest**	742.5 (29.2)	
		Lowest	742.5 (29.2)	
	Sidemarker	Front	510.38 (20.1)	
		Rear	725.4 (28.6)	
Distance from C/L of car to center of bulb	Headlamp	Inside	414.5 (16.3)	
		Outside**	572.0 (22.5)	
	Taillamp	Inside	345.0 (13.6)	
		Outside**	670.0 (26.4)	
	Directional	Front	446.6 (17.6)	
		Rear	506.5 (19.9)	
	Halogen headlamp (std., opt., n.a.)	Lo beam	Standard	
		Hi beam	Standard	
Replaceable bulb		Yes		
Shape		Rectangular		
Headlamp other than above	Lo beam	Not Available		
	Hi beam	"	"	
	Replaceable	"	"	
	Shape	"	"	
	Type	"	"	

* Measured at curb mass (weight).
 ** If single lamps are used enter here.

MVMA Specifications Form
METRIC (U.S. Customary)

Vehicle Line CORSICA
Model Year 1988 Issued 10-86 Revised (*) 3-87

Vehicle Mass (weight)

Model	CURB MASS, kg. (weight, lb.)*			% PASS. MASS DISTRIBUTION				SHIPPING MASS, kg (weight, lb.)**
	Front	Rear	Total	Pass In Front		Pass In Rear		
				Front	Rear	Front	Rear	
Corsica								
4-Door Notchback Sedan	792.3 (1747)	381.8 (842)	1174.1 (2589)					1142.9 (2520)

* Reference - SAE J1100 Motor vehicle dimensions, curb weight definition.
** Shipping mass (weight) definition -

MVMA Specifications Form

METRIC (U.S. Customary)

CORSIKA

Vehicle Line 1988 10-86 3-87
 Model Year Issued Revised (•)

Equipment	Optional Equipment Differential Mass (weight)*			Remarks
	MASS, kg. (weight, lb.)			
	Front	Rear	Total	
Power Door Lock System RPO AU3	1.2 (2.6)	1.8 (4.0)	3.0 (6.6)	
Power Windows RPO A31	1.8 (4.0)	3.2 (7.0)	5.0 (11.0)	
4-Way Mechanical Front - Pass Seat Adjuster RPO A78	.8 (1.8)	1.0 (2.2)	1.8 (4.0)	
Power Trunk Opener RPO A90	-.2 (-0.4)	1.0 (2.2)	.8 (1.8)	
Custom Interior RPO B18	1.0 (2.2)	1.0 (2.2)	2.0 (4.4)	
Floor Mats - Front RPO B34	1.0 (2.2)	.2 (0.4)	1.2 (2.6)	
Floor Mats - Rear RPO B35	.2 (0.4)	.4 (0.9)	.6 (1.3)	
Intermittent Windshield Wiper System RPO CD4	.2 (0.4)	0 (0)	.2 (0.4)	
Electric Rear Window Defogger RPO C49	0 (0)	.6 (1.3)	.6 (1.3)	
Air Conditioning RPO C60	21.8 (48.1)	-1.4 (-3.1)	20.4 (45.0)	With RPO LL8 Engine
	20.4 (45.0)	-1.4 (-3.1)	19.0 (41.9)	With RPO LB6 Engine
Full Floor Console RPO D55	1.8 (4.0)	1.2 (2.6)	3.0 (6.6)	
Heavy Duty Front and Rear Suspension RPO F40	1.4 (3.1)	1.0 (2.2)	2.4 (5.3)	
Sport Suspension RPO F41	2.0 (4.4)	1.4 (3.1)	3.4 (7.5)	Included on 'LT' Model (Z11)
Engine Block Heater RPO K05	.2 (0.4)	0 (0)	.2 (0.4)	
Electronic Speed Control (w/Resume Speed) RPO K34	1.8 (4.0)	0 (0)	1.8 (4.0)	

*Also see Engine - General Section for dressed engine mass (weight).

MVMA Specifications Form

Vehicle Line CORSICA
 Model Year 1988 Issued 10-86 Revised (●) 3-87

METRIC (U.S. Customary)

Equipment	Optional Equipment Differential Mass (weight)*			Remarks
	MASS. kg. (weight, lb.)			
	Front	Rear	Total	
2.8 Liter V6 Engine	49.0	-4.0	45.0	With Manual Transmission
RPO LB6	(108.0)	(-8.8)	(99.2)	
	38.2	-3.2	35.0	With Automatic Transmission
	(84.2)	(-7.0)	(77.2)	
Automatic Transmission	18.4	-1.4	17.0	With RPO LL8 Engine
RPO MX1	(40.6)	(-3.1)	(37.5)	
	28.6	-1.8	26.8	With RPO LB6 Engine
	(63.9)	(-4.0)	(59.0)	
Comfortilt Steering Wheel	.6	.4	1.0	
RPO N33	(1.3)	(0.9)	(2.2)	
Sport Wheel Covers	.4	.6	1.0	
RPO PB2	(0.9)	(1.3)	(2.2)	
Aluminum Wheels - 14"	-.8	-.8	-1.6	
RPO PD8	(-1.8)	(-1.8)	(3.6)	
Styled Steel Wheels-14"	-.2	1.8	1.6	
RPO PC4	(-0.4)	(4.0)	(3.6)	
P195/70 R14 Tires	1.0	1.0	2.0	
Blackwall RPO QAB	(2.2)	(2.2)	(4.4)	
White Stripe RPO QAD				
Heavy Duty Battery	2.4	-.4	2.0	Required with Auto. Trans. on L4. Mandatory for Canada
RPO UA1	(5.3)	(-0.9)	(4.4)	
AM/FM Stereo Radio, Cassette Player with Clock	.8	.2	1.0	
RPO UM6	(1.8)	(0.4)	(2.2)	
AM/FM Stereo Radio with Clock	.2	0	.2	
RPO UM7	(0.4)	(0)	(0.4)	
AM/FM Stereo Radio, Cassette Player, Graphic Equalizer with Clock	1.8	.2	2.0	
RPO UX1	(4.0)	(0.4)	(4.4)	
Dual Note Horns	.4	0	.4	
RPO U05	(0.9)	(0)	(0.9)	

*Also see Engine - General Section for dressed engine mass (weight).

MVMA Specifications Form

Vehicle Line CORSICA
Model Year 1988 Issued 10-86 Revised (•) 3-87

METRIC (U.S. Customary)

Optional Equipment Differential Mass (weight)*				
Equipment	MASS. kg. (weight. lb.)			Remarks
	Front	Rear	Total	
Gage Package With Tachometer RPO U21	.4 (0.9)	0 (0)	.4 (0.9)	
Speaker System (4), Dual Front and Dual Extended Range Rear RPO U66	1.4 (3.1)	1.4 (3.1)	2.8 (6.2)	Included with UM6, UM7, UX1.
Front License Plate Mounting RPO VK3	.4 (0.9)	0 (0)	.4 (0.9)	
Deck Lid Luggage Rack (Black) RPO V56	-.6 (-1.3)	3.2 (7.0)	2.6 (5.7)	
'Corsica LT' Option RPO Z11	5.2 (11.5)	3.2 (7.0)	8.4 (18.5)	

*Also see Engine - General Section for dressed engine mass (weight).

MVMA Specifications Form

METRIC (U.S. Customary)

Exterior Vehicle And Body Dimensions – Key Sheet

Exterior Width

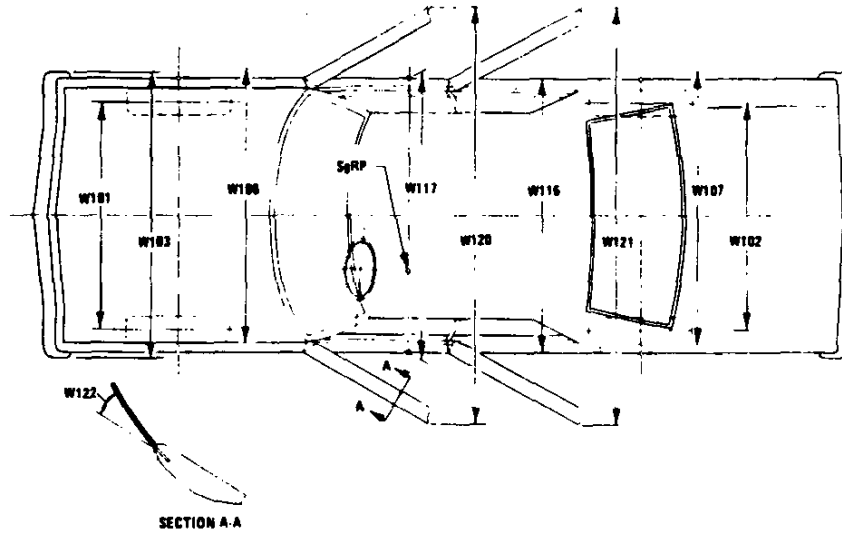

Exterior Length & Height

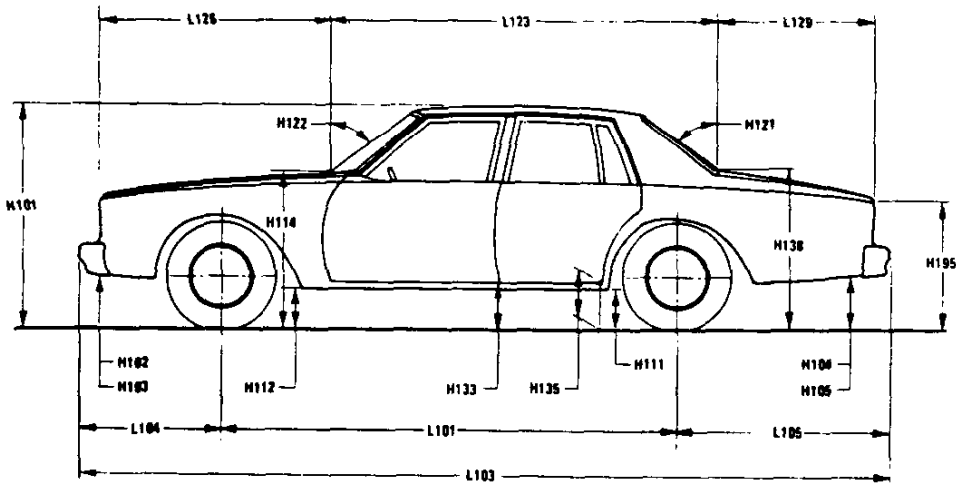

Exterior Ground Clearance

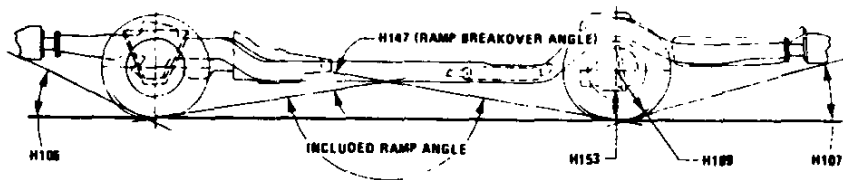

MVMA Specifications Form

METRIC (U.S. Customary)

Interior Vehicle And Body Dimensions – Key Sheet

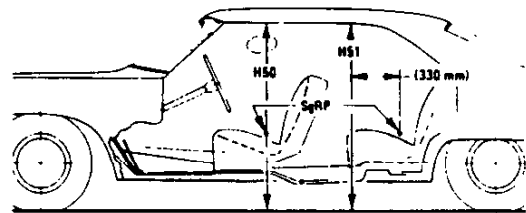
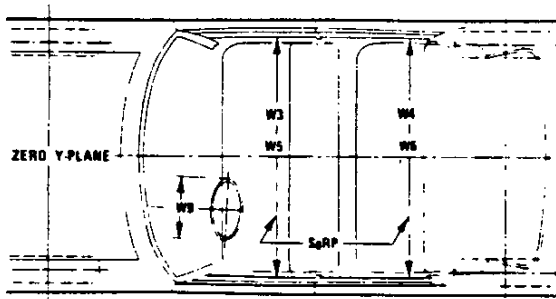
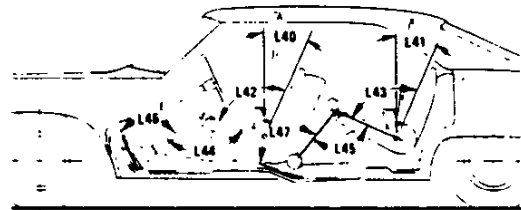
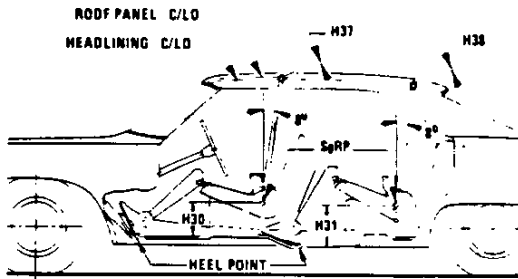
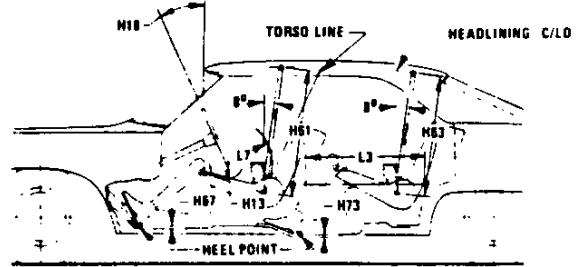
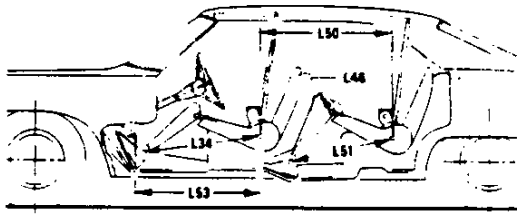

MVMA Specifications Form

METRIC (U.S. Customary)

Interior Vehicle And Body Dimensions - Key Sheet

Third Seat

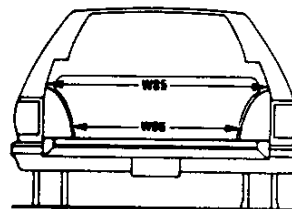
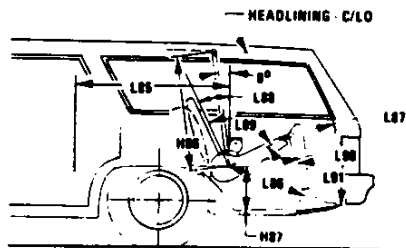

Cargo Space

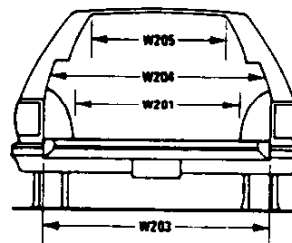
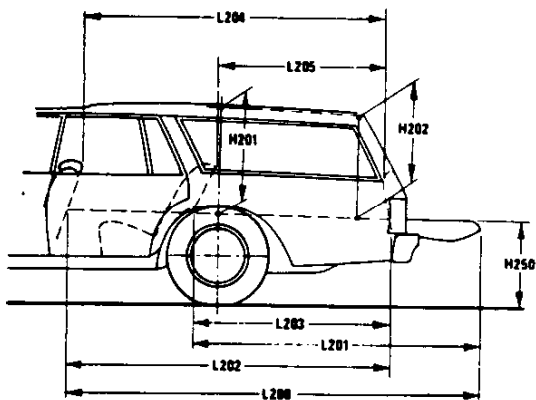

Station Wagon

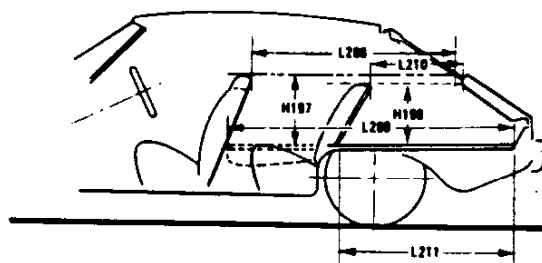

Hatchback

MVMA Specifications Form

METRIC (U.S. Customary)

Exterior Vehicle And Body Dimensions – Key Sheet Dimensions Definitions

Seating Reference Point

SEATING REFERENCE POINT means the manufacturer's design reference point which –

- (a) Establishes the rearmost normal design driving or riding position of each designated seating position in a vehicle;
- (b) Has coordinates established relative to the design vehicle structure;
- (c) Simulates the position of the pivot center of the human torso and thigh; and
- (d) Is the reference point employed to position the two dimensional templates described in SAE Recommended Practice J826, "Devices for Use in Defining and Measuring Vehicle Seating Accommodations."

Width Dimensions

- W101 TREAD–FRONT. The dimension measured between the tire centerlines at the ground.
- W102 TREAD–REAR. The dimension measured between the tire centerlines at the ground. In case of dual wheels, the dimension will be measured to the centerline of tire and wheel assemblies.
- W103 VEHICLE WIDTH. The maximum dimension measured between the widest point on the vehicle, excluding exterior mirrors, flexible mud flaps, marker lamps, but including bumpers, moldings, sheet metal protrusions or dual wheels, if standard equipment.
- W106 FRONT FENDER WIDTH. The dimension measured between the widest points at the front wheel centerline, excluding moldings.
- W107 REAR FENDER WIDTH. The dimension measured between the widest points at the rear wheel centerline, excluding moldings.
- W117 BODY WIDTH AT SgRP–FRONT. The dimension measured laterally between the widest points on the body at the SgRP-front, excluding door handles, applied moldings, or appliques.
- W120 VEHICLE WIDTH–FRONT DOORS OPEN. The dimension measured between the widest point on the front doors in maximum hold-open position.
- W121 VEHICLE WIDTH–REAR DOORS OPEN. The dimension measured between the widest point on the rear doors in maximum hold-open position. For vehicles with a rear door on only one side, this dimension is to the zero "Y" plane.
- W122 TUMBLE–HOME. STRAIGHT SIDE GLASS. The angle measured from a vertical to the outside surface of the front door glass at the SgRP "X" plane.
CURVED SIDE GLASS. The angle measured from a vertical to a chord extending from the upper DLO to the lower DLO at the outside surface of the front door glass at the front SgRP "X" plane.

Length Dimensions

- L101 WHEELBASE (WB). The dimension measured longitudinally between front and rear wheel centerlines. In case of dual rear axles, the dimension shall be to the midpoint of the centerlines of the rear wheels.
- L103 VEHICLE LENGTH. The maximum dimension measured longitudinally between the foremost point and the rearmost point on the vehicle, including bumper, bumper guards, tow hooks and/or rub strips, if standard equipment.
- L104 OVERHANG–FRONT. The dimension measured longitudinally from the centerline of the front wheels to the foremost point on the vehicle including bumper, bumper guards, tow hooks and/or rub strips, if standard equipment.
- L105 OVERHANG–REAR. The dimension measured longitudinally from the centerline of the rear wheels; or in the case

of dual rear axles, the dimension shall be the midpoint of the centerlines of the rear wheels, to the rearmost point on the vehicle including rear bumpers, bumper guards, tow hooks and rub strips, if standard equipment.

- L123 UPPER STRUCTURE LENGTH. The dimension measured longitudinally from the cowl point to the deck point.
- L125 COWL POINT "X" COORDINATE.
- L126 FRONT END LENGTH. The dimension measured longitudinally from the cowl point to the foremost point on the vehicle at the zero "Y" plane excluding ornamentation or bumpers. In cases where bumpers and/or grills are integrated with the profile, measurement is made at the foremost point of front end contour.
- L127 REAR WHEEL CENTERLINE "X" COORDINATE or in the case of dual rear axles, the coordinate shall be the midpoint of the distance between the rear axle centerlines.
- L129 REAR END LENGTH. The dimension measured longitudinally from the deck point to the rearmost visible point of the body sheet metal at the zero "Y" plane, excluding ornamentation or bumpers.

Height Dimensions

- H101 VEHICLE HEIGHT. The dimension measured vertically from the highest point on the vehicle body to ground.
- H111 ROCKER PANEL–REAR TO GROUND. The dimension measured vertically from the bottom of the rocker or side quarter panel at the front of the rear wheel opening, excluding flanges, to ground.
- H112 ROCKER PANEL–FRONT TO GROUND. The dimension measured vertically from the foremost point on the bottom of the rocker panels, excluding flanges, to ground.
- H114 COWL POINT TO GROUND. Measured at zero "Y" plane.
- H121 BACKLIGHT SLOPE ANGLE. The angle between the vertical reference line and the surface of backlight at vehicle zero "Y" plane. For curve backlight, the angle is to chord of backlight arc from lower DLO to upper DLO.
- H122 WINDSHIELD SLOPE ANGLE. The angle between the vertical reference line and a chord of the windshield arc running from the lower DLO to the upper DLO at the vehicle zero "Y" plane. In the case of wrap over glass, the angle to be measured will be formed by a chord 457 mm (18.0 in) long drawn from the lower DLO to the intersecting point on the windshield.
- H127 HEADLAMP TO GROUND–CURB MASS (WT.). The dimension measured vertically from the centerline of the lowest headlamp lens to ground.
- H128 TAILLAMP TO GROUND–CURB MASS (WT.). The dimension measured vertically from the centerline of the upper bulb to ground.
- H133 BOTTOM OF DOOR CLOSED–FRONT TO GROUND. The dimension measured vertically from the bottom outside corner of the door on the lock pillar side, in maximum closed position, to ground.
- H135 BOTTOM OF DOOR CLOSED–REAR TO GROUND. The dimension measured vertically from the bottom outside corner of the door on the lock pillar side in maximum closed position, to ground.
- H138 DECK POINT TO GROUND. Measured at zero "Y" plane.
- H109 STATIC LOAD–TIRE RADIUS–REAR. Specified by the manufacturer in accordance with composite TIRE SECTION STANDARD.

Ground Clearance Dimensions

- H102 FRONT BUMPER TO GROUND. The dimension measured vertically from the lowest bumper to ground, including bumper equipment.
- H103 FRONT BUMPER TO GROUND–(Measured in the same manner as H111

MVMA Specifications Form

METRIC (U.S. Customary)

Interior Vehicle And Body Dimensions – Key Sheet Dimensions Definitions

- H104** REAR BUMPER TO GROUND. The minimum dimension measured vertically from the lowest point on the rear bumper to ground, including bumper guards, if standard equipment.
- H105** REAR BUMPER TO GROUND – CURB MASS (WT.). Measured in the same manner as H104.
- H106** ANGLE OF APPROACH. The angle measured between a line tangent to the front tire static loaded radius arc and the initial point of structural interference forward of the front tire to ground. The limiting structural component shall be designated.
- H107** ANGLE OF DEPARTURE. The angle measured between a line tangent to the rear tire static loaded radius arc and the initial point of structural interference rearward of the rear tire to ground. The limiting component shall be designated.
- H147** RAMP BREAKOVER ANGLE. The angle measured between two lines tangent to the front and rear tire static loaded radius and intersecting at a point on the underside of the vehicle which defines the largest ramp over which the vehicle can roll.
- H153** REAR AXLE DIFFERENTIAL TO GROUND. The minimum dimension measured from the rear axle differential to ground.
- H156** MINIMUM RUNNING GROUND CLEARANCE. The minimum dimension measured from the sprung vehicle to ground. Specify location.
- Glass Areas**
- S1** Windshield area.
- S2** Side windows area. Includes the front door, rear door, vents, and rear quarter windows on both sides of the vehicle.
- S3** Backlight areas.
- S4** Total area. Total of all areas (S1 + S2 + S3).
- Fiducial Mark Dimensions**
- Fiducial Mark – Number 1**
- L54** "X" coordinate.
- W21** "Y" coordinate.
- H81** "Z" coordinate.
- H161** Height "Z" coordinate to ground at curb weight.
- H163** Height "Z" coordinate to ground.
- Fiducial Mark – Number 2**
- L55** "X" coordinate.
- W22** "Y" coordinate.
- W82** "Z" coordinate.
- H162** Height "Z" coordinate to ground at curb weight.
- H164** Height "Z" coordinate to ground.
- Front Compartment Dimensions**
- L7** STEERING WHEEL TORSO CLEARANCE. The minimum dimension measured in the side view from the rearmost edge of the steering wheel, with front wheels in the straight ahead position, to the torso line.
- L11** ACCELERATOR HEEL POINT TO STEERING WHEEL CENTER. The dimension measured horizontally from the AHP to the intersection of the steering column centerline and a plane tangent to the upper surface of the steering wheel rim.
- DESIGN H-POINT–FRONT TRAVEL. The dimension measured horizontally between the design H-point–front in the front and rearmost seat track positions. (See SAE DRIVING AND RIDING SEAT TRACK LEVEL. The dimension measured horizontally between a point on the design H-point travel line from the SgRP to the design H-point travel line with the seat in the rearmost seat position, but not to include seat positions used for purposes other than normal driving conditions. (See SAE J1100) "X" COORDINATED.
- L34** MAXIMUM EFFECTIVE LEG ROOM–ACCELERATOR. The dimension measured along a line from the ankle pivot center to the SgRP–front plus 254 mm (10.0 in) measured with right foot on the undepressed accelerator pedal. For vehicles with SgRP to heel (H30) greater than 18 in., the accelerator pedal may be depressed as specified by the manufacturer. If the accelerator is depressed, the manufacturer shall place foot flat on pedal and note the depression of the pedal.
- L-40** BACK ANGLE–FRONT. The angle measured between a vertical line through the SgRP–front and the torso line. If the seatback is adjustable, use the normal driving and riding position specified by the manufacturer.
- L-42** HIP ANGLE–FRONT. The angle measured between torso line and thigh centerline.
- L44** KNEE ANGLE–FRONT. The angle measured between thigh centerline and lower leg centerline measured on the right leg.
- L46** FOOT ANGLE–FRONT. The angle measured between the lower leg centerline and a line tangent to the ball and heel of the bare foot flesh line measured on the right leg. Ref SAE J826.
- L53** SgRP–FRONT TO HEEL. The dimension measured horizontally from the SgRP–front to the accelerator heel point.
- W3** SHOULDER ROOM–FRONT. The minimum dimension measured laterally between the trimmed surfaces on the "X" plane through the SgRP–front at height between the belt line and 254 mm (10.0 in.) above the SgRP–front, excluding the door assist strap and attaching parts.
- W5** HIP ROOM–FRONT. The minimum dimension measured laterally between the trimmed surfaces on the "X" plane through the SgRP–front within 25 mm (1.0 in.) below and 76 mm (3.0 in.) above the SgRP–front and 76 mm (3.0 in.) fore and aft of the SgRP–front.
- W9** STEERING WHEEL MAXIMUM OUTSIDE DIAMETER. Define if other than round.
- H13** STEERING WHEEL TO CENTERLINE OF THIGH. The minimum dimension measured from the bottom of steering wheel, with front wheels in the straight position, to the thigh centerline.
- H17** ACCELERATOR HEEL POINT TO THE STEERING WHEEL CENTER. The dimension measured vertically from the AHP–front to the intersection of the steering column centerline to a plane tangent to the upper surface of the steering wheel rim.
- H18** STEERING WHEEL ANGLE. The angle measured from a vertical to the surface plane of the steering wheel.
- H30** SgRP–FRONT TO HEEL. The dimension measured vertically from the SgRP–front to the accelerator heel point.
- H37** HEADLINING TO ROOF PANEL–FRONT. The dimension measured from the intersection of the headlining and the extended effective head room line normal to the sheet metal.
- H50** UPPER BODY OPENING TO GROUND–FRONT. The dimension measured vertically from the trimmed body opening to the ground on the SgRP–front "X" plane.
- H61** EFFECTIVE HEAD ROOM–FRONT. The dimension measured along a line 8 deg. rear of vertical from the SgRP–front to the headlining plus 102 mm (4.0 in.).
- H67** FLOOR COVERING THICKNESS–UNDEPRESSED–FRONT. The dimension measured vertically from the surface of the undepressed floor covering to the underbody sheet metal at the accelerator heel point.
- PD1** PASSENGER DISTRIBUTION–FRONT.
- Rear Compartment Dimensions**
- L3** COMPARTMENT ROOM–SECOND. The dimension measured horizontally from the back of the front seat to the front of the second seatback at a height tangent to the top of the second seat cushion.

MVMA Specifications Form

METRIC (U.S. Customary)

Interior Vehicle And Body Dimensions – Key Sheet Dimensions Definitions

- L-41 BACK ANGLE-SECOND. The angle measured between a vertical line through the SgRP-second and the torso line.
- L43 HIP ANGLE-SECOND. The angle measured between torso line and thigh centerline.
- L45 KNEE ANGLE-SECOND. The angle measured between thigh centerline and lower leg centerline.
- L47 FOOT ANGLE-SECOND. The angle measured between the lower leg centerline and a line tangent to the ball and heel of the three-dimensional devices bare foot flesh line (Reference J826).
- L48 KNEE CLEARANCE-SECOND. The minimum dimension measured from the knee pivot center to the back of the front seatback minus 51 mm (2.0 in.).
- L50 SgRP COUPLE DISTANCE-SECOND. The dimension measured horizontally from the driver SgRP-front to the SgRP-second.
- L51 MINIMUM EFFECTIVE LEG ROOM-SECOND. The dimension measured along a line from the ankle pivot center to the SgRP-second plus 254mm (10.0 in.).
- W4 SHOULDER ROOM-SECOND. The minimum dimension measured laterally between door or quarter trimmed surfaces on the "X" plane through the SgRP-second at height between 254-406 mm (10.0-16.0 in.) above the SgRP-second, excluding the door assist straps and attaching parts.
- W6 HIP ROOM-SECOND. Measured in the same manner as W5.
- H31 SgRP-SECOND TO HEEL. The dimension measured vertically from the SgRP-second to the two dimensional device heel point on the depressed floor covering.
- H38 HEADLINING TO ROOF PANEL-SECOND. The dimension measured from the intersection of the headlining and the extended effective head room line normally to the roof sheet metal.
- H51 UPPER BODY OPENING TO GROUND-SECOND. The dimension measured vertically from the trimmed body opening to the ground on the "X" plane 330 mm (13.0 in.) forward of the SgRP-second.
- H63 EFFECTIVE HEAD ROOM-SECOND. The dimension measured along a line 8 deg. rear of vertical from the SgRP to the headlining, plus 102 mm (4.0 in.).
- H73 FLOOR COVERING-DEPRESSED-SECOND. The dimension measured vertically from the heel point to the underbody sheet metal.
- PD2 PASSENGER DISTRIBUTION-SECOND.

Luggage Compartment Dimensions

- V1 USABLE LUGGAGE CAPACITY-Total of volumes of individual pieces of standard luggage set plus H-boxes stowed in the luggage compartment in accordance with the procedure described in paragraph 8.2 of SAE-J1100a.
- H195 LIFTOVER HEIGHT. The dimension measured vertically from the luggage compartment lower opening at the zero "Y" plane to ground.

Interior Volumes (EPA Classification)

The Interior Volume Index is listed for each body style except two seaters. The interior volume index estimates the space in a car. It is based on four measurements – head room, shoulder room, hip room, and leg room – for the front and rear seats, plus trunk capacity. The interior volume index is an estimate of the size of the passenger compartment.

The Trunk/Cargo Index is an estimate of the size of the trunk/cargo space. In station wagons and hatchbacks it is an estimate of the space behind the second seat.

Station Wagon – Third Seat Dimensions

- L85 SgRP COUPLE DISTANCE-THIRD. The dimension measured horizontally from the SgRP-second to the SgRP-third.
- L86 EFFECTIVE LEG ROOM-THIRD. The dimension measured along a line from the ankle pivot center to the SgRP-third plus 254 mm (10.0 in.).
- L87 KNEE CLEARANCE-THIRD. The minimum dimension from the knee pivot center to the back of second seatback minus a constant of 51mm (2.0 in.). With rear-facing third seat, dimension is measured to closure.
- L88 BACK ANGLE-THIRD. Measured in the same manner as L41.
- L89 HIP ANGLE-THIRD. Measured in the same manner as L43.
- L90 KNEE ANGLE-THIRD. Measured in the same manner as L45.
- L91 FOOT ANGLE-THIRD. Measured in the same manner as L47.
- W85 SHOULDER ROOM-THIRD. Measured in the same manner as W4.
- W86 HIP ROOM-THIRD. Measured in the same manner as W5.
- H86 EFFECTIVE HEAD ROOM-THIRD. The dimension, measured along a line 8 deg. from the SgRP-third to the headlining rear of vertical plus a constant of 102 mm (4.0 in.).
- H87 SgRP-THIRD TO HEEL POINT.
- PD3 PASSENGER DISTRIBUTION-THIRD.
- SD1 SEAT FACING DIRECTION-THIRD.

Station Wagon – Cargo Space Dimensions

- L200 CARGO LENGTH-OPEN-FRONT. The minimum dimension measured longitudinally from the back of the front seatback at the height of the undepressed floor covering to the rearmost point on the undepressed floor covering on the open tailgate or cargo surface if the rear closure is a conventional door type tailgate at the zero "Y" plane.
- L201 CARGO LENGTH-OPEN-SECOND. The dimension measured longitudinally from the back of the second seatback at the height of the undepressed floor covering to the rearmost point on the undepressed floor covering on the open tailgate or cargo floor surface if the rear closure is a conventional door type tailgate, at the zero "Y" plane.
- L202 CARGO LENGTH-CLOSED-FRONT. The minimum dimension measured horizontally from the back of the front seat at the height of the undepressed floor covering to the rearmost point on the undepressed floor covering on the closed tailgate or taildoor for station wagons, trucks and mpv's at the zero "Y" plane.
- L203 CARGO LENGTH-CLOSED-SECOND. The dimension measured horizontally from the back of the second seat at the height of the undepressed floor covering to the rearmost point on the undepressed floor covering on the closed tailgate or taildoor for station wagons, trucks and mpv's at the zero "Y" plane.
- L204 CARGO LENGTH AT BELT-FRONT. The minimum dimension measured horizontally from the back of the front seatback at the seatback top to the foremost normal surface of the closed tailgate or inside surface of the cab backpanel at the height of the belt, on the zero "Y" plane.
- L205 CARGO LENGTH AT BELT-SECOND. The minimum dimension measured horizontally from the back of the second seatback at the seatback top to the foremost normal surface of the closed tailgate at the height of the belt, on the zero "Y" plane.
- W201 CARGO WIDTH-WHEELHOUSE. The minimum dimension measured laterally between the trimmed wheelhouseings at floor level. For any vehicle not trimmed, measure to the sheet metal.

MVMA Specifications Form

METRIC (U.S. Customary)

Interior Vehicle And Body Dimensions – Key Sheet Dimensions Definitions

- W203 REAR OPENING WIDTH AT FLOOR.** The minimum dimension measured laterally between the limiting interferences of the rear opening at floor level.
- W204 REAR OPENING WIDTH AT BELT.** The minimum dimension measured laterally between the limiting interferences of the rear opening at belt height or top of pick up box.
- W205 REAR OPENING WIDTH ABOVE BELT.** The minimum dimension measured laterally between the limiting interferences of the rear opening above the belt height.
- H197 FRONT SEATBACK TO LOAD FLOOR HEIGHT.** The dimension measured vertically from the horizontal tangent to the top of the seatback to the undeepressed floor covering.
- H201 CARGO HEIGHT.** The dimension measured vertically from the top of the undeepressed floor covering to the headlining at the rear wheel "X" coordinate on the zero "Y" plane.
- H202 REAR OPENING HEIGHT.** The dimension measured vertically from the top of the undeepressed floor covering to the upper trimmed opening on the zero "Y" plane with rear door fully open.
- H250 TAILGATE TO GROUND CURB MASS (WT.).** The dimension measured vertically from the top of the undeepressed floor covering on the lowered tailgate to ground on the zero "Y" plane.
- V2 STATION WAGON**
Measured in inches:

$$\frac{W4 \times H201 \times L204}{1728} = \text{ft}^3$$
 Measured in mm:

$$\frac{W4 \times H201 \times L204}{10^9} = \text{m}^3 \text{ (cubic meter)}$$
- V4 HIDDEN LUGGAGE CAPACITY-REAR OF FRONT SEAT.** The total volumes of individual pieces of one set of standard luggage stowed in any hidden cargo area below the load floor rear of the front seat.
- V5 TRUCKS AND MPV'S WITH OPEN AREA.**
Measured in inches:

$$\frac{L506 \times W500 \times H503}{1728} = \text{ft}^3$$
 Measured in mm:

$$\frac{L506 \times W500 \times H503}{10^9} = \text{m}^3 \text{ (cubic meter)}$$
- V6 TRUCKS AND MPV'S WITH CLOSED AREA.**
Measured in inches:

$$\frac{L204 \times W500 \times H505}{1728} = \text{ft}^3$$
 Measured in mm:

$$\frac{L204 \times W500 \times H505}{10^9} = \text{m}^3 \text{ (cubic meter)}$$
- V8 HIDDEN LUGGAGE CAPACITY-REAR OF SECOND SEAT.** The total volume of individual pieces of one set of standard luggage stowed in any hidden cargo area below the load floor rear of the second seat.
- V10 STATION WAGON CARGO VOLUME INDEX.**
Measured in inches:

$$\frac{H201 \times L205 \times \frac{W4 + W201}{2}}{1728} = \text{ft}^3$$
 Measured in mm:

$$\frac{H201 \times L205 \times \frac{W4 + W201}{2}}{10^9} = \text{m}^3 \text{ (cubic meter)}$$

Hatchback – Cargo Space Dimensions

All hatchback cargo dimensions are to be taken with the front seat in full down and rear position, and the rear seat foiled down. The hatchback door is in the closed position. (For electrically adjusted seats, see the manufacturer's specifications for Design "H" Point).

- L208 CARGO LENGTH AT FRONT SEATBACK HEIGHT.** The minimum horizontal dimension from the "X" plane tangent to the rearmost surface of the driver's seatback to the inside limiting interference of the hatchback door on the vehicle zero "Y" plane.
- L209 CARGO LENGTH AT FLOOR-FRONT-HATCHBACK.** The minimum horizontal dimension measured at floor level from the rear of the front seatback to the normal limiting interference of the hatchback door on the vehicle zero "Y" plane.
- L210 CARGO LENGTH AT SECOND SEATBACK HEIGHT-HATCHBACK.** The minimum dimension measured from the "X" plane tangent to the rearmost surface of second seatback or the load floor which is stowed at least one half of the H198 dimension height above the rear load floor, to the rearmost inside limiting interference on the zero "Y" plane.
- L211 CARGO LENGTH AT FLOOR-SECOND HATCHBACK.** The minimum horizontal dimension measured at floor level from the rear of the second seatback or load floor panel to the normal limiting interference of the hatchback door on the vehicle zero "Y" plane.
- H197 FRONT SEATBACK TO LOAD HEIGHT.** The dimension measured vertically from the horizontal tangent to the top of the seatback to the undeepressed floor covering.
- H198 SECOND SEATBACK TO LOAD FLOOR HEIGHT.** The dimension measured vertically from the second seat back to the undeepressed floor covering.
- V3 HATCHBACK.**
Measured in inches:

$$\frac{\frac{L208 + L209}{2} \times W4 \times H197}{1728} = \text{ft}^3$$
 Measured in mm:

$$\frac{\frac{L208 + L209}{2} \times W4 \times H197}{10^9} = \text{m}^3 \text{ (cubic meter)}$$
- V4 HIDDEN LUGGAGE CAPACITY-REAR OF FRONT SEAT.** The total volumes of individual pieces of one set of standard luggage stowed in any hidden cargo area below the load floor rear of the front seat.
- V11 HATCHBACK CARGO VOLUME INDEX.** Usable luggage (one (1) stand and luggage set) below floor:
Measured in inches:

$$\frac{\frac{L210 + L211}{2} \times W4 \times H198}{1728} = \text{ft}^3$$
 Measured in mm:

$$\frac{\frac{L210 + L211}{2} \times W4 \times H198}{10^9} = \text{m}^3 \text{ (cubic meter)}$$

MVMA Specifications Form

METRIC (U.S. Customary)

Index

Subject	Page No.	Subject	Page No.
Aerodynamics	22	Passenger Capacity	1
Alternator	16	Passenger Mass Distribution	25
Automatic Transmission/Transaxle	8, 9	Pistons	3
Axis, Steering	14	Power Brakes	12
Axle, Drive, Front, Rear	2, 9, 10	Power, Engine	2
Axle Shafts	10	Power Steering	14
Battery	16	Power Teams	2
Body and Miscellaneous Information	17	Propeller Shaft, Universal Joints	10
Brakes—Parking, Service	12, 13	Pumps — Fuel	6
Camber	15	Water	5
Camshaft	3	Radiator — Cap, Hoses, Core	5
Capacities		Ratios — Axle, Transaxle	2, 9
Cooling System	5	Compression	2
Fuel Tank	6	Steering	14
Lubricants		Transmission/Transaxle	2, 8, 9
Engine Crankcase	4	Rear Axle	2, 9, 10
Transmission/Transaxle	8, 9	Regulator — Alternator	16
Rear Axle	10	Restraint System	18
Car Models	1	Rims	13
Carburetor	2, 6	Rods — Connecting	4
Caster	15	Scrub Radius	14
Choke, Automatic	6	Seats	17
Clutch — Pedal Operated	8	Shock Absorbers, Front & Rear	11
Coil, Ignition	16	Spark Plugs	16
Connecting Rods	4	Speedometer	15
Convenience Equipment	19	Springs — Front & Rear Suspension	11
Cooling System	5	Stabilizer (Sway Bar) — Front & Rear	11
Crankshaft	4	Starting System	16
Cylinders and Cylinder Head	3	Steering	14
Diesel Information	4	Suppression — Ignition, Radio	16
Dimension Definitions		Suspension — Front & Rear	11
Key Sheet — Exterior	27, 30, 31	Tail Pipe	7
Key Sheet — Interior	28, 29, 31, 32, 33	Theft Protection	19
Electrical System	15, 16	Thermostat, Cooling	5
Emission Controls	7	Tires	13
Engine—General		Toe-In	15
Bore, Stroke, Type	3	Torque Converter	9
Compression Ratio	2	Torque — Engine	2, 8, 9
Displacement	2, 3	Transaxle	9
Firing Order, Cylinder Numbering	3	Transmission — Types	2, 8, 9
General Information, Power & Torque	2	Transmission — Automatic	2, 8, 9
Intake System	4	Transmission — Manual	2, 8, 9
Power Teams	2	Transmission — Ratios	2, 9
Exhaust System	7	Tread	20
Equipment Availability, Convenience	19	Trunk Cargo Load	1
Fan, Cooling	5	Trunk Luggage Capacity	21
Filters — Engine Oil, Fuel System	4	Turning Diameter	14
Frame	17	Unitized Construction	17
Front Suspension	11	Universal Joints, Propeller Shaft	10
Front Wheel Drive Unit	10	Vehicle Dimensions	
Fuel System	6	Width	20
Fuel Injection	6	Length	20
Fuel Tank	6	Height	20
Glass	18	Ground Clearance	20
Headroom — Body	21, 22	Front Compartment	21
Heights — Car and Body	20	Rear Compartment	21
Horns	15	Luggage Compartment	21
Horsepower — Brake	2	Station Wagon — Third Seat	22
Ignition System	16	Station Wagon — Cargo Space	22
Inflation — Tires	13	Hatchback — Cargo Space	22
Interior Volumes	21	Fiducial Marks	23
Instruments	15	Valve System	4
Lamps and Headlamp Shape	24	Voltage Regulator	16
Legroom	21, 22	Water Pump	5
Lengths — Car and Body	20	Weights	25, 26
Leveling, Suspension	11	Wheel Alignment	15
Lifters, Valve	4	Wheelbase	20
Linings — Clutch, Brake	8, 12	Wheels & Tires	13
Lubrication — Engine Transmission/Transaxle	4, 8, 9	Wheel Spindle	14
Luggage Compartment	21	Widths — Car and Body	20
Mass	25, 26	Windshield	18
Models	1	Windshield Wiper and Washer	15
Motor Starting	16		
Muffler	7		

1988 Format Change

MVMA Specifications Form

Vehicle Line _____

Model Year _____ Issued _____ Revised (e) _____

METRIC (U.S. Customary)

SUPPLEMENTAL PAGE
