

MANUFACTURERS MOTOR VEHICLE SPECIFICATIONS

METRIC (U.S. Customary)

1989

Manufacturer ISUZU MOTORS LIMITED	Vehicle Line SPECTRUM	
Mailing Address 22-10 Minami-oi 6-chome Shinagawa-ku, Tokyo, Japan	Issued MAY 10, 1988	Revised

Direct questions concerning these specifications to the manufacturer listed above.

The information contained herein is prepared, distributed by, and is solely the responsibility of the vehicle manufacturing company to whose products it relates. This specification form was developed by the vehicle manufacturing companies under the auspices of the Motor Vehicle Manufacturers Association of the United States, Inc.

The General Specifications herein are those in effect at date of compilation and are subject to change without notice or incurring obligation by the manufacturer.



Motor Vehicle Manufacturers Association
of the United States, Inc.

Blank Forms Provided by Technical Affairs Division

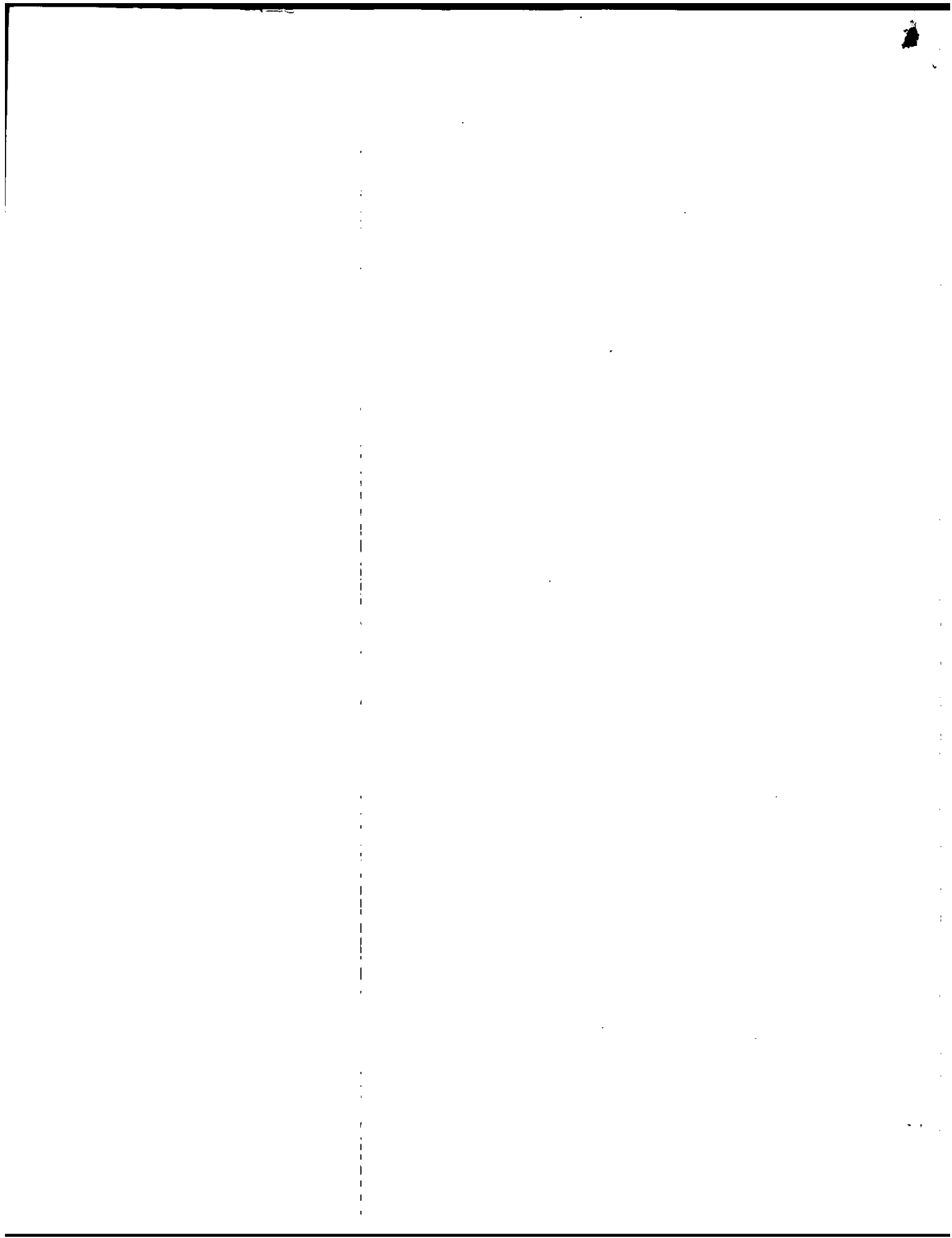

MVMA Specifications Form

METRIC (U.S. Customary)

Table of Contents

Ø	1	Vehicle Models/Origin	Ø Indicates Format Change From Previous Year
	2	Power Teams	
Ø	3-6	Engine	
	4	Lubrication System	
	4	Diesel Information	
	5	Cooling System	
	6	Fuel System	
Ø	7	Vehicle Emission Control	
	7	Exhaust System	
Ø	8-10	Transmission, Axles and Shafts	
Ø	11	Suspension	
	12-13	Brakes	
	13	Tires and Wheels	
	14-15	Steering	
Ø	15-16	Electrical	
Ø	17	Body – Miscellaneous Information	
Ø	18	Restraint System	
	18	Glass	
Ø	18	Headlamps	
	18	Frame	
Ø	19-20	Convenience Equipment	
	21-23	Vehicle Dimensions	
	24	Vehicle Fiducial Marks	
Ø	25	Vehicle Mass (Weight)	
	26	Optional Equipment Differential Mass (Weight)	
	27-33	Vehicle Dimensions Definitions - Key Sheets	
Ø	34	Index	

NOTE:

1. This form uses both SI metric units and U.S. Customary units. The metric unit of measure is presented first, and the U.S. Customary unit follows in parentheses.
2. UNLESS OTHERWISE INDICATED:
 - a. Specifications apply to standard models without optional equipment. Significant deviations are noted.
 - b. Nominal design dimensions are used throughout these specifications.
 - c. All linear dimensions are in millimeters (inches), and all mass (weight) specifications are in kilograms (pounds).
3. The General Specifications herein are those in effect at date of compilation and are subject to change without notice or incurring obligation by the manufacturer.
4. Additional Vehicle Dimensions (based in part on SAE J1100 "Motor Vehicle Dimensions") may be available from the manufacturer.

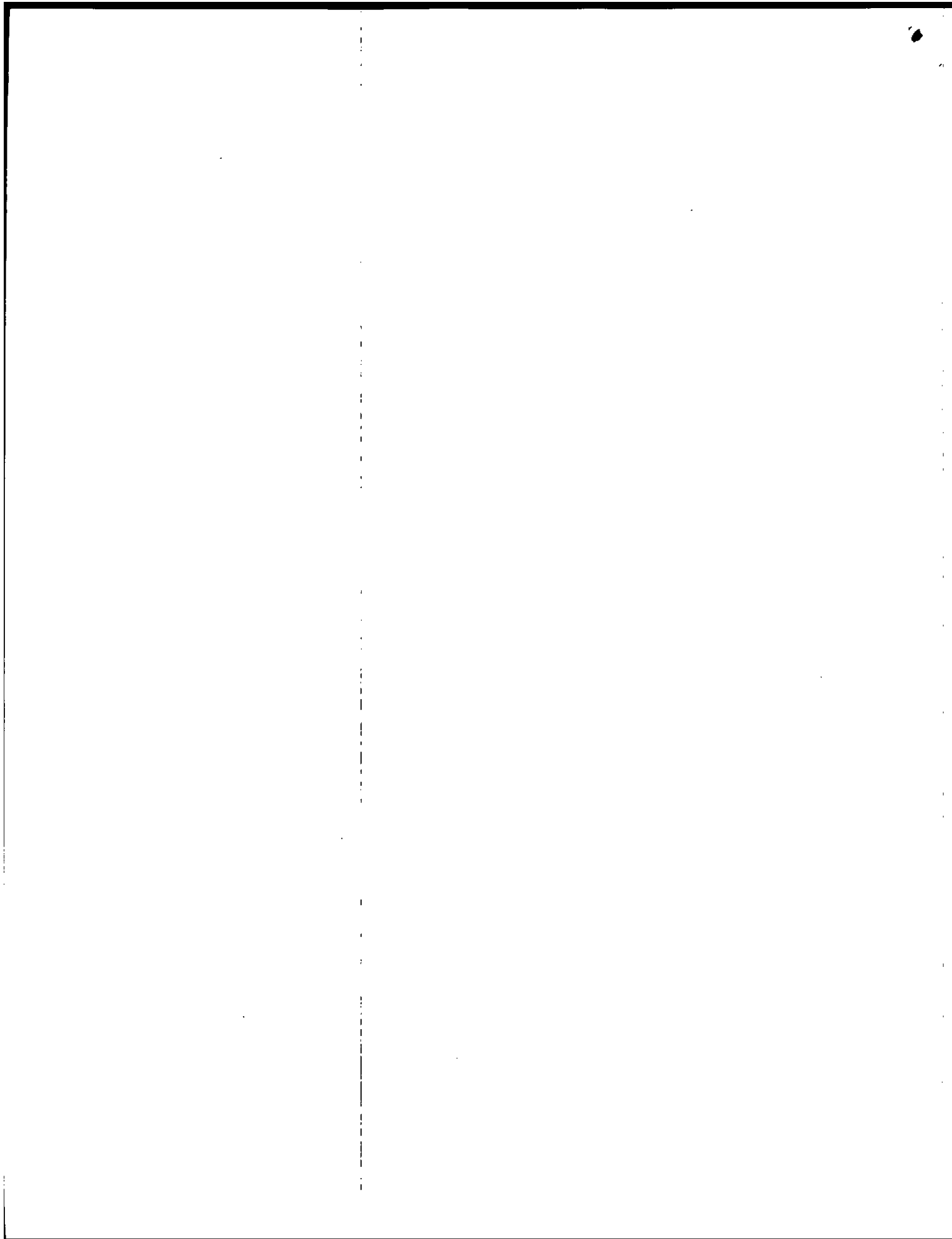

MVMA Specifications Form

METRIC (U.S. Customary)

Vehicle Line SPECTRUM

Model Year 1989 Issued 5/10/'88 Revised (•) _____

Vehicle Origin

Design & development (company)	ISUZU MOTORS LIMITED
Where built (country)	JAPAN
Authorized U.S. sales marketing representative	CHEVROLET

Vehicle Models

Model Description & Drive (FWD/RWD/AWD/4WD)*	Introduction Date	Make, Vehicle Models, Series, Body Type (Mfr's Model Code)	No. of Designated Seating Positions (Front/Rear)		Max. Trunk/Cargo Load—Kilograms (Pounds)
FRONT WHEEL DRIVE		MODEL NUMBER	FRONT/REAR		
3-Door Hatchback		JT150FU	2	2	56.7 (125)
3-Door Turbo Hatchback		JT150FJU	2	2	56.7 (125)
4-Door Notchback		JT150NU	2	2	56.7 (125)
4-Door Turbo Notchback		JT150NJU	2	2	56.7 (125)

* FWD - Front Wheel Drive RWD - Rear Wheel Drive
 AWD - All Wheel Drive 4WD - Four Wheel Drive

MVMA Specifications Form

Vehicle Line SPECTRUM

Model Year 1989 Issued 5/10/'88 Revised (e)

METRIC (U.S. Customary)

Power Teams (Indicate whether standard or optional)

SAE J1349 Net bhp (brake horsepower) and net torque corrected to 77°F/25° C and 29.61 in. Hg/100 kPa atmospheric pressure.

SERIES AVAILABILITY	ENGINE						E x h a u s t S/D*	TRANSMISSION/ TRANSAXLE	AXLE RATIO (std. first)
	Code	Displ. Liters (in ³)	Induction (FI, CARB/ BBL, etc.)	Compr. Ratio	SAE Net at RPM				
					Power kW (bhp)	Torque N·m (lb. ft.)			
JT150FU JT150NU	4XC1-U	1.471 (90)	2BRL	9.6:1	51.5 (70) @ 5400	118 (87) @ 3400	S	Manual 5-spd. Base Auto 3-spd. Avail	3.578 3.526
JT150FJU JT150NJU	4XC1- UT	1.471 (90)	F1	8.0:1	77 (110) @ 5400	162 (120) @ 3400	S	Manual 5-spd.	3.833

* Single / Dual

MVMA Specifications Form

Vehicle Line SPECTRUM

Model Year 1989 Issued 5/10/'88 Revised (e) _____

METRIC (U.S. Customary)

Engine Description/Carb.
Engine Code

4XC1-U

4XC1-UT

ENGINE - GENERAL

Type & description (inline, V, angle, flat, location, front, mid, rear, transverse, longitudinal, sohc, dohc, ohv, hemi, wedge, pre-camber, etc.)	In-line Front Transverse, SOHC, Hemisphere	
Manufacturer	Isuzu Motors Ltd.	
No. of cylinders	4	
Bore	77 (3.03)	
Stroke	79 (3.11)	
Bore spacing (C/L to C/L)	87 (3.4)	
Cylinder block material & mass kg (lbs.) (machined)	Cast iron	
Cylinder block deck height	190 (7.48)	
Cylinder block length	392 (15.4)	
Deck clearance (minimum) (above or below block)	0	
Cylinder head material & mass kg (lbs.)	Aluminum alloy	
Cylinder head volume (cm ³)	37.4 (2.28)	
Cylinder liner material	-	
Head gasket thickness (compressed)	1.2 (0.05)	
Minimum combustion chamber total volume (cm ³)	42.76 (2.61)	52.54 (3.21)
Cyl. no. system (front to rear)*	L Bank	1-2-3-4
	R Bank	-
Firing order	1-3-4-2	
Intake manifold material & mass (kg (lbs.))**	Aluminum alloy	
Exhaust manifold material & mass (kg (lbs.))**	Vermicular cast iron (FCV)	
Fuel required unleaded, diesel, etc.	Unleaded	
Fuel antiknock index (R + M) + 2	87	
Engine mounts	Number	3
	Material and type (elastomeric, hydroelastic, hydraulic damper, etc.)	Elastomeric
	Added isolation (sub-frame, crossmember, etc.)	-
Total dressed engine mass (wt) dry***	90 (198), M/T/85 (187), A/T	98 (216)
Engine - Pistons		
Material & mass, g (weight, oz.) - piston only	Aluminum alloy	
Engine - Camshaft		
Location	Over cylinder head	
Material & mass kg (weight, lbs.)	Cast iron	
Drive type	Chain / belt	Belt
	Width / pitch	19.0 (0.75) / 8.0 (0.3)

* Rear of engine - drive takeoff. View from drive takeoff end to determine left & right side of engine.

** Finished state.

*** Dressed engine mass (weight) includes the following:

MVMA Specifications Form

Vehicle Line SPECTRUM
 Model Year 1989 Issued 5/10/'88 Revised (e) _____

METRIC (U.S. Customary)

Engine Description/Carb.
 Engine Code

4XC1-U	4XC1-UT
--------	---------

Engine - Valve System

Hydraulic lifters (std., opt., NA)	N.A.	
Valves	Number intake / exhaust	4/4
	Head O.D. intake / exhaust	36 (1.42) / 31 (1.22)

Engine - Connecting Rods

Material & mass (kg., (weight, lbs.))*	Forged steel
Length (axis-E to-E) mm	122 (4.8)

Engine - Crankshaft

Material & mass (kg., (weight, lbs.))*	Cast iron	
End thrust taken by bearing (no.)	No. 2	
Length & number of main bearings	17, 5	
Seal (material, one, two piece design, etc.)	Front	Acryl Rubber, one piece design
	Rear	Silicon Rubber, one piece design

Engine - Lubrication System

Normal oil pressure (kPa (psi) at engine rpm)	441/5200
Type oil intake (floating, stationary)	Stationary
Oil filter system (full flow, part. other)	Full flow
Capacity of c/case, less filter-refill-L (qt.)	2.8 (3.0)

Engine - Diesel Information

Diesel engine manufacturer	
Glow plug, current drain at 0°F	
Injector nozzle	Type
	Opening pressure (kPa (psi))
Pre-chamber design	
Fuel injection pump	Manufacturer
	Type
Fuel injection pump drive (belt, chain, gear)	
Supplementary vacuum source (type)	
Fuel heater (yes/no)	
Water separator, description (std., opt.)	
Turbo manufacturer	
Oil cooler-type (oil to engine coolant; oil to ambient air)	
Oil filter	

Engine - Intake System

Turbo charger - manufacturer	N.A.	Ishikawajima-Harima Heavy Industries Co., Ltd.
Super charger - manufacturer	N.A.	
Intercooler	N.A.	

*Finished State

MVMA Specifications Form

Vehicle Line SPECTRUM
 Model Year 1989 Issued 5/10/'88 Revised (e) _____

METRIC (U.S. Customary)

Engine Description/Carb.
 Engine Code

4XC1-U

Engine - Cooling System

Coolant recovery system (std., opt., n.a.)		Std.	
Coolant fill location (rad., bottle)		Bottle	
Radiator cap relief valve pressure (kPa (psi))		103	
Circulation thermostat	Type (choke, bypass)	Bypass	
	Starts to open at °C (°F)	82 (180)	
Water pump	Type (centrifugal, other)	Centrifugal	
	GPM 1000 pump rpm	17 liter/minute at 1000rpm	
	Number of pumps	1	
	Drive (V-belt, other)	Timing Belt	
	Bearing type	Sealed type ball bearing	
	Impeller material	Steel	
Housing material		Aluminum alloy	
By-pass recirculation (type (inter., ext.))		External	
Cooling system capacity	With heater-L(qt.)	6.4 (6.8)	
	With air cond.-L(qt.)	N.A.	
	Opt. equipment (society-L(qt.))	N.A.	
Water jackets full length of cyl. (yes, no)		YES	
Water all around cylinder (yes, no)		YES	
Water jackets open at head face (yes, no)		NO	
Radiator core	Std., A/C, HD	Standard	
	Type (cross-flow, etc.)	Cross-flow	
	Construction (fin & tube mechanical, braze, etc.)	Tube & corrugated fin	
	Material, mass (kg (wgt. lbs.))	Brass & copper	
	Width	410(16.1), M/T / 475(18.7), A/T	
	Height	358 (14.1)	
	Thickness	17.3 (0.68)	
Fins per inch		10 (M/T), 15 (A/T)	
Radiator end tank material		Brass	
Fan	Std., elec., opt.	Std. Elec.	A/C Elec.
	Number of blades & type (flex, solid, material)	-	-
	Diameter & projected width	294 (11.6)	320 (12.6)
	Ratio (fan to crankshaft rev.)	N.A.	N.A.
	Fan cutout type	-	-
	Drive type (direct, remote)	-	-
	RPM at idle (elec.)	2200	2100
	Motor rating (wattage) (elec.)	100	120
	Motor switch (type & location) (elec.)	Water temperature, Radiator tank	
	Switch point (temp., pressure) (elec.)	85°C (185°F)	85°C (185°F)
Fan shroud (material)	N.A.	Steel	

MVMA Specifications Form

Vehicle Line SPECTRUM
 Model Year 1989 issued 5/10/'88 Revised (•) _____

METRIC (U.S. Customary)

Engine Description/Carb.
 Engine Code

4XC1-UT

Engine - Cooling System

Coolant recovery system (std., opt., n.a.)		Std.
Coolant fill location (rad., bottle)		Bottle
Radiator cap relief valve pressure (kPa (psi))		103
Circulation thermostat	Type (choke, bypass)	Bypass
	Starts to open at °C (°F)	82 (180)
Water pump	Type (centrifugal, other)	Centrifugal
	GPM 1000 pump rpm	17 liter/minute at 1000rpm
	Number of pumps	1
	Drive (V-belt, other)	Timing Belt
	Bearing type	Sealed type ball bearing
	Impeller material	Steel
Housing material		Aluminum alloy
By-pass recirculation (type (inter., ext.))		External
Cooling system capacity	With heater-L(qt.)	7.1 (7.5)
	With air cond.-L(qt.)	N.A.
	Opt. equipment (specify-L(qt.))	N.A.
Water jackets full length of cyl. (yes, no)		YES
Water all around cylinder (yes, no)		YES
Water jackets open at head face (yes, no)		NO
Radiator core	Std., A/C, HD	Standard
	Type (cross-flow, etc.)	Cross-Flow
	Construction (fin & tube mechanical, brzs, etc.)	Tube & corrugated fin
	Material, mass (kg (wgt, lbs.))	Brass & copper
	Width	560 (22.0)
	Height	361 (14.2)
	Thickness	32 (1.26)
	Fins per inch	4.6
Radiator end tank material		Brass
Fan	Std., elec., opt.	Std. Elec.
	Number of blades & type (flex. solid, material)	-
	Diameter & projected width	320 (12.6)
	Ratio (fan to crankshaft rev.)	N.A.
	Fan cutout type	-
	Drive type (direct, remote)	-
	RPM at idle (elec.)	1950
	Motor rating (wattage) (elec.)	100
	Motor switch (type & location) (elec.)	Water temperature
	Switch point (temp., pressure) (elec.)	85°C (185°F)
	Fan shroud (material)	N.A.

MVMA Specifications Form

Vehicle Line SPECTRUM

Model Year 1989 Issued 5/10/'88 Revised (e) _____

METRIC (U.S. Customary)

Engine Description/Carb.
Engine Code

4XC1-U	4XC1-UT
--------	---------

Engine - Fuel System (See supplemental page for details of Fuel Injection, Supercharger, Turbocharger, etc. if used)

Induction type: carburetor, fuel injection system, etc.	Carburetor	Fuel Injection
---	------------	----------------

Manufacturer	NIPPON KIKAKI Co., Ltd.	
--------------	-------------------------	--

Carburetor no. of barrels		
---------------------------	--	--

Idle A/F mix.	Present at Mfr.	
---------------	-----------------	--

Fuel injection	Point of injection (no.)	-	4
	Constant, pulse, flow	-	Pulse
	Control (electronic, mech.)	-	Electronic
	System pressure (kPa (psi))	-	250

Idle spd.-rpm (spec. neutral or drive and propane if used)	Manual	750 (neutral)	950 (neutral)
	Automatic	1000 (neutral)	-

Intake manifold heat control (exhaust or water thermostatic or fixed)	Water	
---	-------	--

Air cleaner type	Dry: 1 element, hot air intake	Dry: 1 element
------------------	--------------------------------	----------------

Fuel filter (type/location)		
-----------------------------	--	--

Fuel pump	Type (elec. or mech.)	Diaphragm	Electronic
	Location (eng., tank)	Cylinder head, rear	Fuel tank
	Pressure range (kPa (psi))	35.3	441 - 588
	Flow rate at regulated pressure (L (gal)/hr @ kPa (psi))		

Fuel Tank

Capacity (refill L (gallons))	42 (11.1)
-------------------------------	-----------

Location (describe)	Under rear seat floor
---------------------	-----------------------

Attachment	Bolted
------------	--------

Material & Mass (kg (weight lbs))	Lead-tin plating steel 8.8(19.4) 9.6(21.1)
-----------------------------------	--

Filler pipe	Location & material	Rear-left wheel house, painted steel pipe
	Connection to tank	Rubber hose

Fuel line (material)	Copper plating steel pipe
----------------------	---------------------------

Fuel hose (material)	Rubber hose with intermediate blade
----------------------	-------------------------------------

Return line (material)	Copper plating steel pipe
------------------------	---------------------------

Vapor line (material)	Copper plating steel pipe
-----------------------	---------------------------

Extended range tank	Opt., n.a.	N.A.
	Capacity (L (gallons))	-
	Location & material	-
	Attachment	-

Auxiliary tank	Opt., n.a.	N.A.
	Capacity (L (gallons))	-
	Location & material	-
	Attachment	-
	Selector switch or valve	-
Separate fill	-	

MVMA Specifications Form

Vehicle Line SPECTRUM
 Model Year 1989 Issued 5/10/88 Revised (e)

METRIC (U.S. Customary)

Engine Description/Carb.
 Engine Code

4XC1-U

Vehicle Emission Control

Exhaust Emission Control	Type (air injection, engine modifications, other)		EGR + AS + O ₂ S + TWC (MFC + UFC)
	Air Injection	Pump or pulse	Pulse
		Driven by	-
		Air distribution (head, manifold, etc.)	Exh. mfd.
		Point of entry	No. 4 Port of exh. mfd.
	Exhaust Gas Recirculation	Type (controlled flow, open orifice, other)	Open orifice
		Exhaust source Point of exhaust injection (specr, carburetor, manifold, other)	Cylinder head (Exhaust port) Intake manifold
	Catalytic Converter	Type	TWC
		Number of	2
		Location(s)	Under floor, Exhaust manifold
		Volume (L (in ³))	1.26 (77), 0.69 (42)
		Substrate type	Monolith
		Noble metal type	Pt/Rh, Pt/Rh
	Crankcase Emission Control	Type (ventilates to atmosphere, induction system, other)	Closed
Energy source (manifold vacuum, carburetor, other)		Manifold vacuum Crankcase Pressure	
Discharges (to intake manifold, other)		Intake manifold	
Air inlet (breather cap, other)		Air cleaner	
Evaporative Emission Control	Vapor vented to (crankcase, canister, other)	Fuel tank	Canister
		Carburetor	Canister
	Vapor storage provision	Canister	
Electronic system	Closed loop (yes/no)	Yes	
	Open loop (yes/no)	No	

Engine - Exhaust System

Type (single, single with cross-over, dual, other)		Single
Muffler no. & type (reverse flow, straight thru, separate resonator) Material & Mass (kg (weight lbs))		1, Separate resonator, 3.5 (7.7)
Resonator no. & type		-
Exhaust pipe	Branch o.d., wall thickness	42.7 - 1.6 (1.7 - 0.06)
	Main o.d., wall thickness	-
	Material & Mass (kg (weight lbs))	Aluminized Steel, 3.5 (7.7)
Inter-mediate pipe	o.d. & wall thickness	42.7 - 2.0 (1.7 - 0.08)
	Material & Mass (kg (weight lbs))	Aluminized Steel, 4.5 (9.9)
Tail pipe	o.d. & wall thickness	Ft half: 42.7-1.2(1.7-0.05), Rr half: 38.1-1.2(1.5-0.05)
	Material & Mass (kg (weight lbs))	Aluminized Steel, Stainless Steel 4.8 (10.5)

MVMA Specifications Form

Vehicle Line SPECTRUM
 Model Year 1989 Issued 5/10/'88 Revised (•) _____

METRIC (U.S. Customary)

Engine Description/Carb.
 Engine Code

4XC1-UT

Vehicle Emission Control

Exhaust Emission Control	Type (air injection, engine modifications, other)		EGR + AS + O ₂ S + TWC (MFC + UFC)
	Air Injection	Pump or pulse	Pulse
		Driven by	-
		Air distribution (head, manifold, etc.)	Exh. mfd.
		Point of entry	Before Manifold converter
	Exhaust Gas Recirculation	Type (controlled flow, open orifice, other)	Controlled Flow
		Exhaust source	Cylinder head (Exhaust port)
		Point of exhaust injection (spacer, carburetor, manifold, other)	Intake manifold
	Catalytic Converter	Type	TWC
		Number of	2
Location(s)		Under floor, Exhaust manifold	
Volume (L (in ³))		1.26 (77), 0.69 (42)	
Substrate type		Monolith	
Noble metal type		Pt/Rh, Pt/Rh	
Crankcase Emission Control	Type (ventilates to atmosphere, induction system, other)		Closed
	Energy source (manifold vacuum, carburetor, other)		Manifold vacuum Crankcase pressure
	Discharges (to intake manifold, other)		Intake manifold
	Air filter (breather cap, other)		Air cleaner
Evaporative Emission Control	Vapor vented to (crankcase, canister, other)	Fuel tank Carburetor	Canister -
	Vapor storage provision		Canister
Electronic system	Closed loop (yes/no)		Yes
	Open loop (yes/no)		No

Engine - Exhaust System

Type (single, single with cross-over, dual, other)		Single
Muffler no. & type (reverse flow, straight thru, separate resonator) Material & Mass (kg (weight lbs))		1, Separate resonator, 3.7 (8.2)
Resonator no. & type		-
Exhaust pipe	Branch o.d., wall thickness	50.8 - 1.6 (2.0 - 0.06)
	Main o.d., wall thickness	-
	Material & Mass (kg (weight lbs))	Aluminized Steel, 4.9 (10.8)
Intermediate pipe	o.d. & wall thickness	42.7 - 2.0 (1.7 - 0.08)
	Material & Mass (kg (weight lbs))	Aluminized Steel, 4.5 (9.9)
Tail pipe	o.d. & wall thickness	Ft half: 45.0-1.2, Rr half: 50.8-1.2, 60.5-1.6
	Material & Mass (kg (weight lbs))	Aluminized steel, Stainless steel 4.8 (10.5)

MVMA Specifications Form

Vehicle Line SPECTRUM
 Model Year 1989 Issued 5/10/'88 Revised (•) _____

METRIC (U.S. Customary)

Engine Description/Carb.
 Engine Code

4XC1-U	4XC1-UT
--------	---------

Transmissions/Transaxle (Std., Opt., N.A.)

Manual 3-speed (manufacturer/country)	N.A.
Manual 4-speed (manufacturer/country)	N.A.
Manual 5-speed (manufacturer/country)	Standard, Isuzu Motors Ltd./Japan
Automatic (manufacturer/country)	Optional, Japan Automatic Transmission Co./Japan N.A.
Automatic overdrive (manufacturer/country)	N.A.

Manual Transmission/Transaxle

Number of forward speeds	5		
Gear ratios	1st	3.727	3.500
	2nd	2.043	1.916
	3rd	1.333	1.333
	4th	0.923	0.923
	5th	0.744	0.744
	Reverse	3.583	
Synchronous meshing (specify gears)	All forward gears (1st, 2nd, 3rd, 4th, 5th)		
Shift lever location	Floor		
Trans. case mat'l. & mass kg (lbs)*	Aluminium, 37.5 (82.7)		
Lubricant	Capacity (L (pt.))	1.9 (4.0)	
	Type recommended	API GL-1 (Engine oil)	

Clutch (Manual Transmission)

Clutch manufacturer	DAIKIN			
Clutch type (dry, wet; single, multiple disc)	Dry single			
Linkage (hydraulic, cable, rod, lever, other)	Cable			
Max. pedal effort (nom. spring load, new) N (lbs)	Depressed	108 (24)		
	Released	59 (13)		
Assist (spring, power/percent, nominal)	N.A.	Spring		
Type pressure plate springs	Diaphragm			
Total spring load (nominal, new) N (lbs)	3626 (815)	4900 (1102)		
Clutch facing	Facing mfr. & material coding	ASAHI SEKIMEN NC80	NC80A	
	Facing material & construction	Organic semi-mold		
	Rivets per facing	16	18	
	Outside x inside dia. (nominal)	184x127 (7.2x5.0)	215x154 (8.4x6.0)	
	Total eff. area (cm ² (in. ²))	139 (21.5)	177 (27.4)	
	Thickness (pressure plate side/ fly wheel side)	3.2 (0.13)	3.5 (0.14)	
	Rivet depth (pressure plate side/ fly wheel side)	1.2-1.8	1.3-1.9	
Engagement cushion method	Cushion spring			
Release bearing type & method lub.	Self centering single row ballbearing, sealed grease			
Torsional damping method, springs, hysteresis	Rubber	Coil spring		

* Includes shift linkage, lubricant, and clutch housing. If other specify.

MVMA Specifications Form

Vehicle Line SPECTRUM
 Model Year 1989 Issued 5/10/'88 Revised (e) _____

METRIC (U.S. Customary)

Engine Description/Comb.
 Engine Code

4XC1-U

Automatic Transmission/Transaxle

Trade name		KF100
Type and special features (describe)		Torque converter with automatically operated planetary gear
Selector	Location	Floor
	Ltr./No. designation	P-R-N-D-2-1
Gear ratios	1st	2.841
	2nd	1.541
	3rd	1.000
	4th	-
	Reverse	2.400
Max. upshift speed - drive range (km/h (mph))		58 (1-2), 107 (2-3), [36mph (1-2), 67mph (2-3)]
Max. lockdown speed - drive range (km/h (mph))		43 (2-1), 98 (3-2), [27mph (2-1), 61mph (3-2)]
Min. overdrive speed (km/h (mph))		-
Torque converter	Number of elements	3
	Max. ratio at stall	2.0
	Type of cooling (air, liquid)	Water
	Nominal diameter	224 (8.8)
	Capacity factor "K"	
Lubricant	Capacity (refill L (pt.))	6.5
	Type Recommended	ATF DEXRON-II
Oil cooler (std., opt., NA, internal, external, air, liquid)		Std., External, water
Transmission case material & mass (kg (lbs))**		

Axle or Front Wheel Drive Unit

Type (front, rear)		Front wheel drive
Description		Helical Gear
Limited slip differential (type)		N.A.
Drive pinion offset		-
Drive pinion (type)		Helical Gear
No. of differential pinions		2
Pinion/differential adjustment (shim, other)		Shim adjustment
Pinion/differential bearing adjustment (shim, other)		Shim adjustment
Driving wheel bearing (type)		Double row, angular ball bearing
Lubricant	Capacity (L (pt.))	N.A. part of transmission assembly
	Type recommended	Transmission lub.

Axle or Transaxle Ratio and Tooth Combinations (See 'Power Teams' for axle ratio usage.)

Axle ratio (or overall top gear ratio)		3.578 (M/T)	3.526 (A/T)
No. of teeth	Pinion	19	19
	Ring gear or gear	68	67
Ring gear o.d.		203.6 (8.0)	194.8 (7.7)
Transaxle	Transfer gear ratio	-	-
	Final drive ratio	-	-

* Input speed + $\sqrt{\text{torque}}$

** Includes shift linkage, lubricant, & clutch housing, if other specify.

MVMA Specifications Form

Vehicle Line SPECTRUM
 Model Year 1989 issued 5/10/'88 Revised (•) _____

METRIC (U.S. Customary)

Engine Description/Carb.
 Engine Case

4XC1-UT

Automatic Transmission/Transaxle

Trade name		N.A.	
Type and special features (describe)			
Selector	Location	/	
	Ltr./No. designation		
Gear ratios	1st		
	2nd		
	3rd		
	4th		
	Reverse		
Max. upshift speed - drive range (km/h (mph))			/
Max. kickdown speed - drive range (km/h (mph))			
Min. overdrive speed (km/h (mph))			
Torque converter	Number of elements		
	Max. ratio at stall		
	Type of cooling (air, liquid)		
	Nominal diameter		
Lubricant	Capacity factor "K"		
	Capacity (refill L (pt.))		
Type Recommended			
Oil cooler (std., opt., NA, internal, external, air, liquid)			
Transmission case material & mass kg (lbs)**		N.A.	

Axle or Front Wheel Drive Unit

Type (front, rear)		Front wheel drive
Description		Helical Gear
Limited slip differential (type)		N.A.
Drive pinion offset		-
Drive pinion (type)		Helical Gear
No. of differential pinions		2
Pinion/differential adjustment (shim, other)		Shim adjustment
Pinion/differential bearing adjustment (shim, other)		Shim adjustment
Driving wheel bearing (type)		Double row, angular ball bearing
Lubricant	Capacity (L (pt.))	N.A. Part of transmission assembly
	Type recommended	Transmission lub.

Axle or Transaxle Ratio and Tooth Combinations (See "Power Teams" for axle ratio usage.)

Axle ratio (or overall top gear ratio)		3.833
No. of teeth	Pinion	18
	Ring gear or gear	69
Ring gear o.d.		206.4 (8.1)
Transaxle	Transfer gear ratio	-
	Final drive ratio	-

* Input speed + $\sqrt{\text{torque}}$

** Includes shift linkage, lubricant, & clutch housing, if other specify.

MVMA Specifications Form

Vehicle Line SPECTRUM
 Model Year 1989 Issued 5/10/'88 Revised (e) _____

METRIC (U.S. Customary)

Engine Description/Carb.
 Engine Code

4XC1-U

Axle Shafts – Front Wheel Drive

Manufacturer and number used		NTN (M/T RH, LH, A/T LH), NSK (A/T RH) 2		
Type (straight, solid bar, tubular, etc.)	Left	Straight solid bar		
	Right	Straight solid bar		
Outer diam. x length* x wall thickness	Manual transaxle	Left	22x377 (0.87x14.8)	
		Right	22x646 (0.87x25.4)	
	Automatic transaxle	Left	22x335 (0.87x13.2)	
		Right	22x688 (0.87x27.1)	
	Optional transaxle	Left	N.A.	
		Right	N.A.	
Slip yoke	Type	N.A.		
	Number of teeth	-		
	Spline o.d.	-		
Universal joints	Make and mtg. no.	Inner	NTN94147572 (M/T RH, LH, A/T LH), NSK94158055 (A/T RH)	
		Outer	NTN94147571 (M/T RH, LH, A/T LH), NSK94158067 (A/T RH)	
	Number used	4		
	Type, size, plunge	Inner	Double offset DOJ 82 Plunging (NTN), TRI-PORTED (NSK)	
		Outer	Berfield BJ 82 fixed	
	Attach (u-bolts, clamp, etc.)	Snapring		
Bearing	Type (plain, anti-friction)	N.A.		
	Lubrication (fitting, prepack)	-		
Drive taken through (torque tube, arms or springs)		-		
Torque taken through (torque tube, arms or springs)		-		

All Wheel / 4 Wheel Drive

Description and type (part-time, full-time, 2/4 shift, while moving, mechanical, elect., chain/gear, etc.)		_____	
Transfer case	Manufacturer	_____	
	Type		
	Model		
Low-range gear ratio		_____	
System disconnect (describe)			
Center differential	Type (bevel, planetary, w or w/o viscous bias, torsen, etc.)	_____	
	Torque split (% front/rear)		

* Centerline to centerline of universal joints, or to centerline of attachment.

MVMA Specifications Form

Vehicle Line SPECTRUM
 Model Year 1989 Issued 5/10/'88 Revised (e) _____

METRIC (U.S. Customary)

Engine Description/Carb. Engine Code

4XC1-UT

Axle Shafts – Front Wheel Drive

Manufacturer and number used		NTN 2		
Type (straight, solid bar, tubular, etc.)	Left	Straight solid bar		
	Right	Straight solid bar		
Outer diam. x length* x wall thickness	Manual transaxle	Left	27x377 (1.06x14.8)	
		Right	27x377 (1.06x14.8)	
	Automatic transaxle	Left	N.A.	
		Right	N.A.	
	Optional transaxle	Left	N.A.	
		Right	N.A.	
Spline yoke	Type	N.A.		
	Number of teeth	-		
	Spline o.d.	-		
Universal joints	Make and mg. no.	Inner	NTN 94449726	
		Outer	NTN 94449727	
	Number used	4		
	Type, size, plunge	Inner	Double offset DOJ 87 Plunging	
		Outer	Berfield BJ 87 fixed	
	Attach (U-bolts, clamp, etc.)	Snapring		
Bearing	Type (plan, anti-friction)	N.A.*		
	Lubrication (fitting, grease)	-		
Drive taken through (torque tube, arms or springs)		-		
Torque taken through (torque tube, arms or springs)		-		

All Wheel/4 Wheel Drive

Description and type (part-time, full-time, 2/4 shift wire moving, mechanical, elect., chain/gear, etc.)		
Transfer case	Manufacturer	
	Type	
	Model	
Low-range gear ratio		
System disconnect (describe)		
Center differential	Type (bevel, planetary, w or w/o viscous diss. torque, etc.)	
	Torque split (% front/rear)	

* Centerline to centerline of universal joints, or to centerline of attachment.

MVMA Specifications Form

Vehicle Line SPECTRUM
 Model Year 1989 Issued 5/10/'98 Revised (e) _____

METRIC (U.S. Customary)

Body Type And/Or
 Engine Displacement

HATCHBACK (JT150FU)
NOTCHBACK (JT150NU)

Suspension - General Including Electronic Controls

Car leveling	Standard/optional/not avail.	N.A.	
	Manual/automatic control	-	
	Type (air/hydraulic)	-	
	Primary/assist spring	-	
	Rear only/4 wheel leveling	-	
	Single/dual rate spring	-	
	Single/dual ride heights	-	
	Provision for jacking	-	
Shock absorber damping controls	Standard/option/not avail.	N.A.	
	Manual/automatic control	-	
	Number of damping rates	-	
	Type of actuation (manual/electric motor/air, etc.)	-	
	s e n s o r s	Lateral acceleration	-
		Deceleration	-
Acceleration		-	
Shock absorber (front & rear)	Type	Double acting hydraulic telescopic	
	Make	KAYABA	
	Piston diameter	Ft: 30 (1.18), Rr: 20 (0.79)	
	Rod diameter	Ft: 18 (0.71), Rr: 10 (0.39)	

Suspension - Front

Type and description	MacPherson strut	
Travel*	Full jounce	89 (3.5)
	Full rebound	73 (2.9)
Spring	Type (coil, leaf, other) & material	Coil, SUP 7 or SAE 9254
	Insulators (type & material)	Seat rubbers (top & bottom)
	Size (coil design height & i.d., bar length x dia.)	
	Spring rate (N/mm (lb./in.))	19.6 (112)
Stabilizer	Rate at wheel (N/mm (lb./in.))	14.8 (84.5)
	Type (link, linkless, frameless)	N.A.
	Material & bar diameter	-

Suspension - Rear

Type and description	Trailing arm with stamped control arms and open section transverse beam	
Travel*	Full jounce	122 (4.80)
	Full rebound	67 (2.64)
Spring	Type (coil, leaf, other) & material	Progressive-rate coil, SUP 7 or SAE 9254
	Size (length x width, coil design height & i.d., bar length & dia.)	228.5 (9.0) x 154 (6.1) x 8.2 (0.3) x 13.8 (0.54)
	Spring rate (N/mm (lb./in.))	25.5 - 51.0 (146 - 291)
	Rate at wheel (N/mm (lb./in.))	12.7 - 25.4 (72.5 - 145)
	Insulators (type & material)	Seat rubbers (top)
	If leaf	No. of leaves
Shackle (comp. or tens.)		N.A.
Stabilizer	Type (link, linkless, frameless)	N.A.
	Material & bar diameter	-
Track bar (type)	N.A.	

* Define load condition:

MVMA Specifications Form

Vehicle Line SPECTRUM
 Model Year 1989 Issued 5/10/'88 Revised (e) _____

METRIC (U.S. Customary)

Body Type And/Or
 Engine Displacement

HATCHBACK (JT150FU)
NOTCHBACK (JT150NU) **OPTIONAL SUSPENSION**

Suspension - General including Electronic Controls

Car leveling	Standard/optional/not avail.	N.A.	
	Manual/automatic control	-	
	Type (air/hydraulic)	-	
	Primary/assist spring	-	
	Rear only/4 wheel leveling	-	
	Single/dual rate spring	-	
	Single/dual ride heights	-	
	Provision for locking	-	
Shock absorber damping controls	Standard/option/not avail.	N.A.	
	Manual/automatic control	-	
	Number of damping rates	-	
	Type of actuation (manual/electric motor/air, etc.)	-	
	s e n s o r s	Lateral acceleration	-
		Deceleration	-
		Acceleration	-
Road surface		-	
Shock absorber (front & rear)	Type	Double acting hydraulic telescopic	
	Make	KAYABA	
	Piston diameter	Ft: 30 (1.18), Rr: 20 (0.79)	
	Rod diameter	Ft: 20 (0.79), Rr: 10 (0.39)	

Suspension - Front

Type and description	MacPherson Strut	
Travel*	Full bounce	89 (3.5)
	Full rebound	73 (2.9)
Spring	Type (coil, leaf, other) & material	Coil, SUP 7 or SAE 9254
	Insulators (type & material)	Seat rubbers (top & bottom)
	Size (coil design height & l.d., bar length x dia.)	
	Spring rate (N/mm (lb./in.))	23.5 (134)
Stabilizer	Rate at wheel (N/mm (lb./in.))	17.8 (102)
	Type (link, linkless, frameless)	Linkless
	Material & bar diameter	S45 ϕ 22

Suspension - Rear

Type and description	Trailing arm with stamped control arms and open section transverse beam	
Travel*	Full bounce	122 (4.80)
	Full rebound	67 (2.64)
Spring	Type (coil, leaf, other) & material	Progressive-rate coil, SUP 7 or SAE 9254
	Size (length x width, coil design height & l.d., bar length & dia.)	196.5 (7.7) x 154 (6.1) x 8.5 (0.3) x 13.5 (0.53)
	Spring rate (N/mm (lb./in.))	27.4 - 51.0 (156 - 291)
	Rate at wheel (N/mm (lb./in.))	13.7 - 25.4 (78.2 - 145)
	Insulators (type & material)	Seat rubbers (top)
	# leaf	No. of leaves
Shocks (comb. or tens.)		N.A.
Stabilizer	Type (link, linkless, frameless)	Linkless
	Material & bar diameter	S54 ϕ 16
Track bar (type)	N.A.	

* Define load condition:

MVMA Specifications Form

Vehicle Line SPECTRUM
 Model Year 1989 Issued 5/10/'88 Revised (e) _____

METRIC (U.S. Customary)

Body Type And/Or
 Engine Displacement

HATCHBACK (JT150FJU)
NOTCHBACK (JT150NJU)

Suspension - General Including Electronic Controls

Car leveling	Standard/optional/not avail.	N.A.	
	Manual/automatic control	-	
	Type (air/hydraulic)	-	
	Primary/assist spring	-	
	Rear only/4 wheel leveling	-	
	Single/dual rate spring	-	
	Single/dual ride heights	-	
	Provision for jacking	-	
Shock absorber damping controls	Standard/option/not avail.	N.A.	
	Manual/automatic control	-	
	Number of damping rates	-	
	Type of actuation (manual/electric motor/br, etc.)	-	
	s e n s o r s	Lateral acceleration	-
		Deceleration	-
		Acceleration	-
Road surface		-	
Shock absorber (front & rear)	Type	Double acting hydraulic telescopic	
	Make	KAYABA	
	Piston diameter	Ft: 30 (1.18), Rr: 20 (0.79)	
	Rod diameter	Ft: 20 (0.79), Rr: 10 (0.39)	

Suspension - Front

Type and description		MacPherson strut
Travel*	Full jounce	89 (3.5)
	Full rebound	73 (2.9)
Spring	Type (coil, leaf, other) & material	Coil, SUP 7 or SAE 9254
	Insulators (type & material)	Seat rubbers (top & bottom)
	Size (coil design height & i.d., bar length x dia.)	338.5 (13.3) x 115 (4.5) x 12.3 (0.48)
	Spring rate (N/mm (lb./in.))	23.5 (134)
Stabilizer	Rate at wheel (N/mm (lb./in.))	17.8 (102)
	Type (link, linkless, frameless)	Linkless
	Material & bar diameter	S45 ϕ 22

Suspension - Rear

Type and description		Trailing arm with stamped control arms and open section transverse beam
Travel*	Full jounce	122 (4.80)
	Full rebound	67 (2.64)
Spring	Type (coil, leaf, other) & material	Progressive-rate coil, SUP 7 or SAE 9254
	Size (length x width, coil design height & i.d., bar length & dia.)	221.5 (8.7) x 154 (6.1) x 8.5 (0.3) x 13.5 (0.53)
	Spring rate (N/mm (lb./in.))	27.4 - 51.0 (156 - 291)
	Rate at wheel (N/mm (lb./in.))	13.7 - 25.4 (78.2 - 145)
	Insulators (type & material)	Seat rubbers (top)
	If leaf	No. of leaves
Shackle (comp. or tens.)		N.A.
Stabilizer	Type (link, linkless, frameless)	Linkless
	Material & bar diameter	S45 ϕ 16
Track bar (type)		N.A.

* Define load condition:

MVMA Specifications Form

Vehicle Line SPECTRUM
 Model Year 1989 Issued 5/10/'88 Revised (e)

METRIC (U.S. Customary)

Body Type And/Or
 Engine Displacement

HATCHBACK (JT150FU)
 NOTCHBACK (JT150NU)

Brakes - Service

Description		Hydraulic, front disc, rear leading trailing, Self-adjusting		
Manufacturer and brake type (std., opt., n.a.)	Front (disc or drum)	Disc		
	Rear (disc or drum)	Drum		
Valving type (proportion, delay, metering, other)		Proportion		
Power brake (std., opt., n.a.)		Standard		
Booster type (remote, integral, vac., hyd., etc.)		Integral vacuum servo		
Vacuum	Source (inline, pump, etc.)	Inline		
	Reservoir (volume in. ³) and source	N.A.		
	Pump-type (elec. gear driven, belt driven)	N.A.		
Traction control		-		
Operational speed range		-		
Type engine intervention (electronic, mech.)		-		
Anti-lock device	Front/rear (std., opt., n.a.)	N.A.		
	Manufacturer	-		
	Type (electronic, mech.)	-		
	Number sensors or circuits	-		
	Number anti-lock hydraulic circuits	-		
	Integral or add-on system	-		
	Yaw control (yes, no)	-		
Hydraulic power source (elec. vac. mtr., pow. strg.)		-		
Effective area (cm ² (in. ²))*		Ft: 125.6 (19.5), Rr: 172 (26.7)		
Gross lining area (cm ² (in. ²))** (F/R)		Ft: 125.6 (19.5), Rr: 172 (26.7)		
Swept area (cm ² (in. ²))*** (F/R)		Ft: 957 (148.3), Rr: 283 (43.9)		
Rotor	Outer working diameter	F/R	225 (8.86) / -	
	Inner working diameter	F/R	142 (5.59) / -	
	Thickness	F/R	11.0 (0.43) / -	
	Material & type (vented/solid)	F/R	Cast iron, solid / -	
Drum	Diameter & width	F/R	- / 180 (7.09) x 25 (0.98)	
	Type and material	F/R	- / Cast iron	
Wheel cylinder bore		Ft: 54 (2.1), Rr: 17.5 (0.7)		
Master cylinder	Bore/stroke	F/R	20.6 (0.81) / 31.0 (1.22)	
Pedal arc ratio		4.2:1		
Line pressure at 445 N (100 lb.) pedal load (kPa (psi))		8679 kPa at 66.7 kPa vacuum		
Lining clearance		F/R	Self-adjusting	
Brake lining	Front wheel	Bonded or riveted (rivets/seg.)		Bonded
		Rivet size		-
		Manufacturer		SUMITOMO
		Lining code****		M9020FF
		Material		Resin molded (Semi Metallic)
		Size	Primary or out-board	82.0 (3.2) x 41.5 (1.6) x 10.0 (0.4)
		Size	Secondary or in-board	82.0 (3.2) x 41.5 (1.6) x 10.0 (0.4)
	Shoe thickness (no lining)		4.5 (0.18)	
	Rear wheel	Bonded or riveted (rivets/seg.)		Bonded
		Manufacturer		AKEBONO
		Lining code****		AKP330FF
		Material		Resin molded
		Size	Primary or out-board	172 (26.7) x 25 (0.98) x 4.1 (0.16)
		Size	Secondary or in-board	172 (26.7) x 25 (0.98) x 4.1 (0.16)
Shoe thickness (no lining)		1.4 (0.06)		

*Excludes rivet holes, grooves, chamfers, etc.

**Includes rivet holes, grooves, chamfers, etc.

***Total swept area for four brakes. (Drum brake: Widest lining contact width for each brake x its contact circumference.)
 (Disc brake: Square of Outer Working Diameter minus Square of inner Working Dia. multiplied by Pi/2 for each brake.)

****Size for drum brakes includes length x width x thickness.

*****Manufacturer I.D., catalog or formulation designation and coefficient of friction classification.

MVMA Specifications Form

METRIC (U.S. Customary)

Vehicle Line SPECTRUM
 Model Year 1989 Issued 5/10/88 Revised (e) _____

Body Type And/Or
 Engine Displacement

HTACHBACK (JT150FJU)
 NOTCHBACK (JT150NJU)

Ø Brakes - Service

Description		Hydraulic, front disc, rear leading trailing, self-adjusting	
Manufacturer and brake type (std., opt., n.a.)	Front (disc or drum)	Disc	
	Rear (disc or drum)	Drum	
Valving type (proportion, delay, metering, other)		Proportion	
Power brake (std., opt., n.a.)		Standard	
Booster type (remota, integral, vac., hyd., etc.)		Integral vacuum servo	
Vacuum	Source (inline, pump, etc.)	Inline	
	Reservoir (volume in. ³) and source	N.A.	
	Pump-type (elec. gear driven, belt driven)	-	
Traction control	Operational speed range	-	
	Type engine intervention (electronic, mech.)	-	
Anti-lock device	Front/rear (std., opt., n.a.)	N.A.	
	Manufacturer	-	
	Type (electronic, mech.)	-	
	Number sensors or circuits	-	
	Number anti-lock hydraulic circuits	-	
	Integral or add-on system	-	
	Yaw control (yes, no)	-	
Hydraulic power source (elec., vac. mtr., pwr. strg.)		-	
Effective area (cm ² /in. ²)**		Ft: 158 (19.5), Rr: 172 (26.7)	
Gross lining area (cm ² /in. ²)***(F/R)		Ft: 158 (19.5), Rr: 172 (26.7)	
Swept area (cm ² /in. ²)***(F/R)		Ft: 1040 (148.3), Rr: 283 (43.9)	
Rotor	Outerworking diameter	F/R	229 (9.02) / -
	Inner working diameter	F/R	139 (5.47) / -
	Thickness	F/R	18 (0.7) / -
	Material & type (vented/solid)	F/R	Cast iron, vented / -
Drum	Diameter & width	F/R	-/180 (7.09) x 25 (0.98)
	Type and material	F/R	-/Cast iron
Wheel cylinder bore		Ft: 54 (2.1), Rt: 17.5 (0.7)	
Master cylinder	Bore/stroke	F/R	22.2 (0.875) / 31.0 (1.22)
Pedal arc ratio		4.2:1	
Line pressure at 445 N(100 lb.) pedal load (kPa (psi))		9721 kPa at 66.7 kPa Vacuum	
Lining clearance		F/R	Self-adjusting
Brake lining	Front wheel	Bonded or riveted (rivets/seg.)	Bonded
		Rivet size	-
		Manufacturer	NISSHINBO
		Lining code*****	N321FE
		Material	Resin molded (Semi Metallic)
		Size Primary or out-board	102 (4.0) x 45 (1.8) x 8.2 (0.3)
		Size Secondary or in-board	102 (4.0) x 45 (1.8) x 8.2 (0.3)
	Shoe thickness (no lining)	4.5 (0.18)	
	Rear wheel	Bonded or riveted (rivets/seg.)	Bonded
		Manufacturer	AKEBONO
		Lining code*****	AKP330FF
		Material	Resin molded
		Size Primary or out-board	172 (26.7) x 25 (0.98) x 4.1 (0.16)
		Size Secondary or in-board	172 (26.7) x 25 (0.98) x 4.1 (0.16)
Shoe thickness (no lining)		1.4 (0.06)	

*Excludes rivet holes, grooves, chamfers, etc. **Includes rivet holes, grooves, chamfers, etc.
 ***Total swept area for four brakes. (Drum brake: Widest lining contact width for each brake x its contact circumference.)
 (Disc brake: Square of Outer Working Dia. minus Square of Inner Working Dia. multiplied by P/2 for each brake.)
 ****Size for drum brakes includes length x width x thickness. *****Manufacturer I.D., catalog or formulation designation and coefficient of friction classification.

MVMA Specifications Form

Vehicle Line SPECTRUM
 Model Year 1989 Issued 5/10/'88 Revised (e) _____

METRIC (U.S. Customary)

Body Type And/Or
 Engine Displacement

HATCHBACK (JT150FU)	HATCHBACK (JT150FJU)
NOTCHBACK (JT150NU)	NOTCHBACK (JT150NJU)

Tires And Wheels (Standard)

Tires	Size (load range, ply)	P155/80R13	P185/60R14	
	Type (bias, radial, steel, nylon, etc.)	Radial (Mud & Snow)	Radial	
	Inflation pressure (cold) for recommended max. vehicle load	Front [kPa (psi)]	240	
		Rear [kPa (psi)]	240	
	Rev./mile—at 70 km/h (45 mph)	919	921	
Wheels	Type & material	Wide rim with deep bottom, steel	Aluminum	
	Rim (size & flange type)	4 1/2J-13	5 1/2J-14	
	Wheel offset	49 (1.93)	49 (1.93)	
	Attachment	Type (bolt or stud)	Nut	
		Circle diameter	100 (3.94)	
Number & size		4, M12x1.5		
Spare	Tire and wheel	Tire: P155/80 D13 Wheel: 4 1/2J-13		
	Storage position & location (describe)	Flat under rear load floor		

Tires And Wheels (Optional)

Tire size (load range, ply)	P175/70R13	P185/60R14
Type (bias, radial, steel, nylon, etc.)	Radial (Mud & Snow)	Radial
Wheel (type & material)	Wide rim with deep bottom, steel	
Rim (size, flange type and offset)	5J-13	5J-14
Tire size (load range, ply)	-	
Type (bias, radial, steel, nylon, etc.)	-	
Wheel (type & material)	-	
Rim (size, flange type and offset)	-	
Tire size (load range, ply)	-	
Type (bias, radial, steel, nylon, etc.)	-	
Wheel (type & material)	-	
Rim (size, flange type and offset)	-	
Tire size (load range, ply)	-	
Type (bias, radial, steel, nylon, etc.)	-	
Wheel (type & material)	-	
Rim (size, flange type and offset)	-	
Ø Spare tire and wheel size (if configuration is different than road tire or wheel, describe optional spare tire and/or wheel location & storage position)	-	

Brakes - Parking

Type of control	Grip handle	
Location of control	In console between front seats	
Operates on	Rear service brakes	
If separate from service brakes	Type (internal or external)	N.A.
	Drum diameter	-
	Lining size (length x width x thickness)	-

MVMA Specifications Form

Vehicle Line SPECTRUM

Model Year 1989 Issued 5/10/'88 Revised (e) _____

METRIC (U.S. Customary)

Body Type And/Or
Engine Displacement

HATCHBACK (JT150FU)
NOTCHBACK (JT150NU)

HATCHBACK (JT150FJU)
NOTCHBACK (JT150NJU)

Steering

Manual (std., opt., n.a.)	Standard	N.A.		
Power (std., opt., n.a.)	Optional	Standard		
Adjustable steering wheel/column (tilt, telescope, other)	Type	Tilt		
	Manufacturer	NIPPON SEIKO		
	(Std., opt., n.a.)	Optional		
Wheel diameter** (W9) SAE J1100	Manual	382 (15.0)		
	Power	382 (15.0)		
Turning diameter m (ft.)	Outside front	Wall to wall (l. & r.)	10.6 (34.78)	
		Curb to curb (l. & r.)	10.0 (32.81)	
	Inside rear	Wall to wall (l. & r.)	-	
		Curb to curb (l. & r.)	-	
Scrub Radius*	-4.1 (-0.16)	-1.0 (-0.39)		
Manual	Gear	Type	Rack and Pinion	
		Manufacturer	JIDOSHA KIKI	
	Ratios	Gear	∞	
		Overall	20:1	
No. wheel turns (stop to stop)	3.52			
Power	Type (coaxial, elec., hyd., etc.)	Coaxial		
	Manufacturer	JIDOSHA KIKI and SAGINAW		
	Gear	Type	Rack and Pinion	
		Ratios	Gear	∞
			Overall	16:1
	Pump (drive)	Belt		
No. wheel turns (stop to stop)	2.88			
Linkage	Type	Accar man		
	Location (front or rear of wheels, other)	Rear of wheels		
	Tie rods (one or two)	Two		
Steering axis	Inclination at camber (deg.)	16°		
	Bearings (type)	Upper	Ball bearing	
		Lower	Needle bearing	
		Thrust	N.A.	
Steering spindle & joint type	N.A.			
Wheel spindle/hub	Diameter	Inner bearing	34.0 (1.34)	
		Outer bearing	64.0 (2.52)	
	Thread (size)	M20x1		
	Bearing (type)	Double row, angular ball bearing Double row, taper roller beari		

**The horizontal distance in the front elevation between wheel centerline and longpin (ball joint) axle at ground.

***See Page 22

MVMA Specifications Form

Vehicle Line SPECTRUM
 Model Year 1989 Issued 5/10/'88 Revised (e) _____

METRIC (U.S. Customary)

Body Type And/Or
 Engine Displacement

HATCHBACK (JT150FU)
 NOTCHBACK (JT150NU)

Wheel Alignment

Front wheel at curb mass (wt.)	Service checking	Caster (deg.)	$2^{\circ}15' \pm 30'$
		Camber (deg.)	$+20' \pm 1^{\circ}$
		Toe-in (outside track-mm (in.))	0 ± 2
	Service reset*	Caster	$2^{\circ}15' \pm 30'$
		Camber	$+20' \pm 1^{\circ}$
		Toe-in	0 ± 2
	Periodic M.V. inspection	Caster	$2^{\circ}15' \pm 30'$
		Camber	$+20' \pm 1^{\circ}$
		Toe-in	0 ± 2
Rear wheel at curb mass (wt.)	Service checking	Camber (deg.)	$-10' \pm 1^{\circ}$
		Toe-in (outside track-mm (in.))	2 ± 2
	Service reset*	Camber	$-10' \pm 1^{\circ}$
		Toe-in	2 ± 2
	Periodic M.V. inspection	Camber	$-10' \pm 1^{\circ}$
		Toe-in	2 ± 2

* Indicates pre-set, adjustable, trend set or other.

Electrical - Instruments and Equipment

Speedometer	Type (analog, digital, std., opt.)	Analogue, round, Standard
	Trip odometer (std., opt., n.a.)	Optional
EGR maintenance indicator		N.A.
Charge indicator	Type	Tell-Tale Warning light
	Warning device (light, audible)	Light
Temperature indicator	Type	Electrical gauge with pointer
	Warning device (light, audible)	-
Oil pressure indicator	Type	Tell-Tale warning light
	Warning device (light, audible)	Light
Fuel indicator	Type	Electrical gauge with pointer
	Warning device (light, audible)	Light
Windshield wiper	Type (standard)	Electric 2-speed
	Type (optional)	Intermittent windshield wiper system
	Blade length	450 (17.7)
	Swept area (cm ² (in. ²))	5590 (866.5)
Windshield washer	Type (standard)	Electric
	Type (optional)	N.A.
	Fluid level indicator (light, audible)	N.A.
Rear window wiper, wiper/washer (std., opt., n.a.)		Optional
Horn	Type	Vibrator
	Number used	1

Other

MVMA Specifications Form

Vehicle Line SPECTRUM
 Model Year 1989 Issued 5/10/'88 Revised (e)

METRIC (U.S. Customary)

Body Type And/Or
 Engine Displacement

HATCHBACK (JT150FJU)
 NOTCHBACK (JT150NJU)

Wheel Alignment

Front wheel at curb mass (WL)	Service checking	Caster (deg.)	2°15' ± 30'
		Camber (deg.)	-30' ± 1°
		Toe-in (outside track-mm (in.))	0 ± 2
	Service reset*	Caster	2°15' ± 30'
		Camber	-30' ± 1°
		Toe-in	0 ± 2
	Periodic M.V. inspection	Caster	2°15' ± 30'
		Camber	-30' ± 1°
		Toe-in	0 ± 2
Rear wheel at curb mass (WL)	Service checking	Camber (deg.)	-10' ± 1°
		Toe-in (outside track-mm (in.))	2 ± 2
	Service reset*	Camber	-10' ± 1°
		Toe-in	2 ± 2
	Periodic M.V. inspection	Camber	-10' ± 1°
		Toe-in	2 ± 2

* Indicates pre-set, adjustable, trend set or other.

Electrical - Instruments and Equipment

Speedometer	Type (analog, digital, std., opt.)	Analogue, round, Standard
	Tire odometer (std., opt., n.a.)	Standard
EGR maintenance indicator		N.A.
Charge indicator	Type	Tell-Tale Warning light & Electrical gauge with point
	Warning device (light, audible)	Light
Temperature indicator	Type	Electrical gauge with pointer
	Warning device (light, audible)	-
Oil pressure indicator	Type	Electrical gauge with pointer
	Warning device (light, audible)	-
Fuel indicator	Type	Electrical gauge with pointer
	Warning device (light, audible)	Light
Windshield wiper	Type (standard)	Electric 2-speed
	Type (optional)	Intermittent windshield wiper system
	Blade length	450 (17.7)
	Sweep area (cm ² (in. ²))	5590 (866.5)
Windshield washer	Type (standard)	Electric
	Type (optional)	N.A.
	Fluid level indicator (light, audible)	N.A.
Rear window wiper, wiper/washer (std., opt., n.a.)		N.A.
Horn	Type	Vibrator
	Number used	1
Other		

MVMA Specifications Form

Vehicle Line SPECTRUM
 Model Year 1989 Issued 5/10/'88 Revised (•) _____

METRIC (U.S. Customary)

Engine Description/Carb.
 Engine Code

4XC1-U

Electrical - Supply System

Battery	Manufacturer	FURUKAWA, NIHONDENCHI, MATSUSHITA	
	Model, std., (opt.)	50D20L	
	Voltage	12	
	Amps at 0°F cold crank	300	
	Minutes-reserve capacity	75	
	Amp/hrs. - 20 hr. rate	50	
Location		Engine compartment left front	
Alternator	Manufacturer	NIPPON DENSO	
	Rating (idle/max. rpm)	Alternating current 12V-50A	
	Ratio (alt. crank/rev.)	133/45	
	Output at idle (rpm, park)	25A (M/T)	31A (A/T)
	Optional (type & rating)	Alternating current 12V-60A (with A/C)	
Regulator	Type	Non-contact voltage control relay	

Electrical - Starting System

Start, motor	Manufacturer	NIPPON DENSO	
	Current drain at 0°F	-	
	Power rating (kw (hp))	0.7	
Motor drive	Engagement type	Solenoid	
	Pinion engages from (front, rear)	Front	

Electrical - Ignition System

Type	Electronic (std., opt., n.a.)	Standard		
	Other (specify)	N.A.		
Coil	Manufacturer	Nippon Denso (build in distributor asm) (I.I.A)		
	Model	TH1G61 (M/T), TH1G41 (A/T)		
	Current	Engine stopped - A		
Spark plug	Manufacturer	NIPPON DENSO	NGK	AC
	Model	W20EXR-V11	BPR6ES-11	R42XLS
	Thread (mm)	14 (0.55)	14 (0.55)	14 (0.55)
	Tightening torque (N·m (lb. ft))	18.6±4.9	18.6±4.9	18.6±4.9
	Gap	1.05 (0.04)	1.05 (0.04)	1.05 (0.04)
	Number per cylinder	1		
Distributor	Manufacturer	Nippon Denso		
	Model	TH1G61 (M/T), TH1G41 (A/T)		

Electrical - Suppression

Locations & type	Resistive cord Resistive spark plug
------------------	--

MVMA Specifications Form

Vehicle Line SPECTRUM

Model Year 1989 Issued 5/10/'88 Revised (•) _____

METRIC (U.S. Customary)

Engine Description/Carb.
Engine Code

4XC1-UT

Electrical - Supply System

Battery	Manufacturer	FURUKAWA, NIHONDENCHI, MATSUSHITA		
	Model, std., (opt.)	50D20L		
	Voltage	12		
	Amps at 0°F cold crank	300		
	Minutes-reserve capacity	75		
	Amps/hrs. - 20 hr. rate	50		
	Location	Engine compartment left front		
Alternator	Manufacturer	NIPPON DENSO		
	Rating (idle/max. rpm)	Alternating current 12V-50A		
	Ratio (alt. crank/rev.)	2.66:1		
	Output at idle (rpm, park)	39A		
	Optional (type & rating)	Alternating current 12V-60A (with A/C)		
Regulator	Type	Non-contact voltage control relay		

Electrical - Starting System

Start, motor	Manufacturer	NIPPON DENSO		
	Current drain at 0°F	-		
	Power rating (kw (hp))	0.8		
Motor drive	Engagement type	Solenoid		
	Pinion engages from (front, rear)	Front		

Electrical - Ignition System

Type	Electronic (std., opt., n.a.)	Standard		
	Other (specify)	N.A.		
Coil	Manufacturer	Delco Remy		
	Model			
	Current	Engine stopped - A		
		Engine idling - A		
Spark plug	Manufacturer	NIPPON DENSO	NGK	AC
	Model	W20EXR-V11	BPR6ES-11	R42XLS
	Thread (mm)	14 (0.55)	14 (0.55)	14 (0.55)
	Tightening torque (N-m (lb. ft))	18.6±4.9	18.6±4.9	18.6±4.9
	Gap	1.05 (0.04)	1.05 (0.04)	1.05 (0.04)
	Number per cylinder	1		
Distributor	Manufacturer	Delco Remy		
	Model			

Electrical - Suppression

Locations & type	Resistive cord Resistive spark plug
------------------	--

MVMA Specifications Form

Vehicle Models SPECTRUM
 Model Year 1989 Issued 5/10/'88 Revised (e) _____

METRIC (U.S. Customary)

Body Type

HATCHBACK (JT150FU JT150FJU)	NOTCHBACK (JT150NU JT150NJU)
---------------------------------	---------------------------------

Body

Structure

Monocoque body

Bumper system
front - rear

Large plastic type

Anti-corrosion treatment

Various sealer, wax coat,
under coat, galvanized steel

Body - Miscellaneous Information

Type of finish (lacquer, enamel, other)

Enamel

Hood	Material & mass		
	Hinge location (front, rear)	Rear	
	Type (counterbalance, prop)	Prop	
	Release control (internal, external)	Internal	
Trunk lid	Material & mass	-	
	Type (counterbalance, other)	-	Counter balance
	Internal release control (elec., mech., n.s.)	-	Optional, mechanical
Hatch-back lid	Material & mass	-	
	Type (counterbalance, other)	Counter balance	
	Internal release control (elec., mech., n.s.)	Optional, mechanical	
Tailgate	Material & mass	N.A.	
	Type (drop, lift, door)	N.A.	
	Internal release control (elec., mech., n.s.)	N.A.	
Vent window control (crank, friction, pivot, power)	Front	Crank	
	Rear	N.A.	Crank
Window regulator type (cable, tape, flex, drive, etc.)	Front		
	Rear		
Seat cushion type (e.g., 60/40, bucket, bench, wire, foam etc.)	Front	Spring + Foam pad	
	Rear	Wire frame + Foam pad	
	3rd seat	N.A.	
Seat back type (e.g., 60/40, bucket, bench, wire, foam etc.)	Front	Spring + Foam pad	
	Rear	Panel frame + Foam pad	Wire frame + foam pad
	3rd seat	N.A.	

MVMA Specifications Form
METRIC (U.S. Customary)

Vehicle Line SPECTRUM
 Model Year 1989 issued 5/10/'88 Revised (*) _____

Body Type

HATCHBACK (JT150FU JT150FJU)	NOTCHBACK (JT150NU JT150NJU)
-----------------------------------	-----------------------------------

Restraint System

Seating Position		Left	Center	Right	
Active	Type & description (lap & shoulder belt, lap belt, etc.) Standard / optional	First seat	3-Pt. SEAT BELT WITH E.L.R. -STANDARD	-	3-Pt. SEAT BELT WITH E.L.R. -STANDARD
		Second seat	2-Pt. SEAT BELT WITH A.L.R. -STANDARD	-	2-Pt. SEAT BELT WITH A.L.R. -STANDARD
		Third seat	-	-	-
Passive	Type & description (air bag, motorized - 2-point belt, fixed belt, knee bolster, manual - lap belt) Standard / optional	First seat	N.A.	-	N.A.
		Second seat	N.A.	-	N.A.
		Third seat	-	-	-

Glass	SAE Ref. No.		
Windshield glass exposed surface area (cm ² (in. ²))	S1	7479 (1159)	
Side glass exposed surface area (cm ² (in. ²)) - total 2-sides	S2	12240 (1897)	10600 (1643)
Backlight glass exposed surface area (cm ² (in. ²))	S3	7403 (1143)	5144 (797)
Total glass exposed surface area (cm ² (in. ²))	S4	27122 (4204)	23223 (3600)
Windshield glass (type)		Laminated glass	
Side glass (type)		Tempered glass	
Backlight glass (type)		Tempered glass	

Lamps and Headlamp Locations

Headlamps	Description - sealed beam, halogen, replaceable bulb, etc.	Replaceable Bulb, HB1
	Shape	Quadrangle
	Lo-beam type (2A1, 2B1, 2C1, etc.)	-
	Quantity	2
	Hi-beam type (1A1, 2A1, 1C1, 2C1, etc.)	-
	Quantity	2

Frame

Type and description (separate frame, unitized frame, partially-unitized frame)	Partially unitized
---	--------------------

MVMA Specifications Form
METRIC (U.S. Customary)

Vehicle Line SPECTRUM
 Model Year 1989 Issued 5/10/'88 Revised (e)

Body Type

HATCHBACK (JT150FU JT150FJU)	NOTCHBACK (JT150NU)
---------------------------------	---------------------

Convenience Equipment (standard, optional, n.a.)

<input checked="" type="checkbox"/> Air conditioning (manual, auto. temp control)	Optional, manual
Clock (digital, analog)	Optional, digital (in radio)
Compass/thermometer	N.A.
Console (floor, overhead)	Standard, floor
Defroster, elec. backlight	Optional, rear electrical defogger
Diagnostic monitor (integrated, individual)	Standard, Tell-tale Warning light in instrument
Instrument cluster (list instruments)	N.A.
Keyless entry	N.A.
Electronic Tripmeter (avg. spd., fuel)	N.A.
Voice alert (list items)	N.A.
Other	-
Fuel door lock (remote, key, electric)	Optional, mechanical
Auto head on/off delay, dimming	N.A.
Cornering	N.A.
Courtesy (map, reading)	Optional (Foot-2)
Door lock, ignition	N.A.
Engine compartment	N.A.
Fog	N.A.
Glove compartment	N.A.
Trunk	Optional (luggage) N.A.
Illuminated entry system (list lamps, activation)	
Other	Dome lamp-standard
Day/night (auto, man.)	Optional, manual
L.H. (remote, power, heated)	Standard, manual remote, manual
R. H. (convex, remote, power, heated)	Optional, convex manual remote
Visor vanity (RH / LH, illuminated)	Optional, RH
<input checked="" type="checkbox"/> Navigation system (describe)	
Parking brake-auto release (warning light)	N.A.

MVMA Specifications Form

METRIC (U.S. Customary)

Vehicle Line SPECTRUM
 Model Year 1989 Issued 5/10/'88 Revised (e) _____

Body Type

NOTCHBACK (JT150NJU)

Convenience Equipment (standard, optional, n.a.)

<input checked="" type="checkbox"/>	Air conditioning (manual, auto, temp control)	Optional, manual
	Clock (digital, analog)	Optional, digital (in radio)
	Compass / thermometer	N.A.
	Console (floor, overhead)	Standard, floor
	Defroster, elec. backlight	Standard, rear electrical defogger
Electronic	Diagnostic monitor (integrated, individual)	Standard, Tell-Tale Warning light in instrument
	Instrument cluster (list instruments)	N.A.
	Keypass entry	N.A.
	Trimmer (avg. spd., fuel)	N.A.
	Voice alert (list items)	N.A.
	Other	-
	Fuel door lock (remote, key, electric)	N.A.
Lamps	Auto head on / off delay, dimming	N.A.
	Cornering	N.A.
	Courtesy (m.e.p. reading)	Standard (Foot-2)
	Door lock, ignition	N.A.
	Engine compartment	N.A.
	Fog	N.A.
	Glove compartment	N.A.
	Trunk	N.A.
<input checked="" type="checkbox"/>	Illuminated entry system (list lamps, activation)	
	Other	Dome lamp-Standard
Mirrors	Day / night (auto, man.)	Standard, manual
	L.H. (remote, power, heated)	Standard, manual remote
	R. H. (convex, remote, power, heated)	Optional, convex manual remote
	Visor vanity (RH / LH, illuminated)	Standard, RH
<input checked="" type="checkbox"/>	Navigation system (describe)	N.A.
	Parking brake-auto release (warning light)	N.A.

MVMA Specifications Form
METRIC (U.S. Customary)

Vehicle Line SPECTRUM
 Model Year 1989 Issued 5/10/'88 Revised (e)

Body Type

HATCHBACK (JT150FU)	NOTCHBACK (JT150NU)
JT150FJU)	JT150NJU)

Convenience Equipment (standard, optional, n.a.)

Ø	Deck lid (release, pull down)		N.A.	
	Door locks (manual, automatic, describe system)		N.A.	
	Power equipment	Seats	2 - 4 - 6 way, etc.	N.A.
			Reclining (R.H., L.H.)	N.A.
			Memory (R.H., L.H., preset, recline)	N.A.
			Lumbar, hip, thigh, support	N.A.
			Heated (R.H., L.H., other)	N.A.
	Side windows		N.A.	
	Vent windows		N.A.	
	Rear windows		N.A.	
Ø	Antenna (location, whip, w / shield, power)		Standard, on roof front-left, non-power	
	Standard		-	
	Optional	AM, FM, stereo, tape, compact disc, graphic equalizer, theft deterrent, radio prep package, headphone jacks, etc.	AM monaural AM/FM stereo AM/FM stereo, tape	
	Speaker (number, location)		Standard - Ft 2 speakers Optional - Rr 2 speakers	
Roof open air fixed (flip-up, sliding, "T")		N.A.		
Speed control device		Optional		
Speed warning device (light, buzzer, etc.)		N.A.		
Tachometer (rpm)		Optional		
Telephone system (describe)		N.A.		
Theft deterrent system		Lock mounted on steering column: Lock steering wheel automatic transmission shift lever and ignition		

MVMA Specifications Form

Vehicle Models SPECTRUM

Model Year 1989 Issued 5/10/'88 Revised (e) _____

METRIC (U.S. Customary)

Vehicle Dimensions See Key Sheets for definitions

All dimensions to ground are for comparative purposes only. Dimensions are to be shown for all base body models of each vehicle line. SAE Ref. no. refers to the definition published in SAE Recommended Practice J1100 "Motor Vehicle Dimensions," unless otherwise specified.

Body Type	SAE Ref. No.	HATCHBACK (JT150FU)	NOTCHBACK (JT150NU)
Width:			
Tread (front)	W101	1390 (54.7)	
Tread (rear)	W102	1380 (54.3)	
Vehicle width	W103	1616 (63.6)	
Body width at Sg RP (front)	W117	1600 (63.0)	
Vehicle width (front doors open)	W120	3469 (136.6)	
Vehicle width (rear doors open)	W121	-	3186 (125.4)
			3056 (120.3)
Front fender overall width	W106	1595 (62.8)	
Rear fender overall width	W107	1598 (62.9)	
Tumble-home (deg.)	W122	21.5°	
Vehicle width including mirrors			

Length

Wheelbase	L101	2400 (94.5)	
Vehicle length	L103	3997 (157.4)	4069 (160.2)
Overhang (front)	L104	815 (32.1)	
Overhang (rear)	L105	782 (30.8)	854 (33.6)
Upper structure length	L123	2657 (104.6)	2394 (94.3)
Rear wheel C/L "X" coordinate	L127	2226 (87.6)	
Cowl point "X" coordinate	L125	155 (6.1)	
Front end length at centerline	L126	1055 (41.5)	
Rear end length at centerline	L129	106 (4.2)	441 (17.4)

★ Height

Passenger distribution (front/rear)	P01.2.3	2/2	-
Trunk/cargo load		56.7 (125)	-
Vehicle height	H101	1320 (52.0)	
Cowl point to ground	H114	915 (36.0)	
Deck point to ground	H138	870 (34.3)	905 (35.6)
Rocker panel-front to ground	H112	172 (6.8)	
Bottom of door closed-front to ground	H133	242 (9.5)	244 (9.6)
Rocker panel-rear to ground	H111	158 (6.2)	
Bottom of door closed-rear to ground	H135	-	235 (9.3)
Windshield slope angle	H122	58.1°	
Backlight slope angle	H121	59.4°	50°

★ Ground Clearance

Front bumper to ground	H102	231 (9.1)	
Rear bumper to ground	H104	195 (7.7)	191 (7.5)
Bumper to ground (front at curb mass (wt.))	H103	253 (10.0)	
Bumper to ground (rear at curb mass (wt.))	H105	281 (11.1)	276 (10.9)
Angle of approach (degrees)	H106	20.8°	
Angle of departure (degrees)	H107	16.6°	
Ramp breakover angle (degrees)	H147	13.0°	
Axle differential to ground (front / rear)	H153	-	
Min. running ground clearance	H156	138 (5.4)	
Location of min. run. grd. clear.		Front Exhaust Pipe	

** All Vehicle Height And Ground Clearance Are Made Using EPA Loaded Vehicle Weight, Loading Conditions.

EPA Loaded Vehicle Weight is the Base Vehicle Weight Plus All Coolant And Fluids Necessary For Operation Plus 100% Of The Fuel Capacity. Plus The Weight Of All Options And Accessories Which Weigh Three Pounds Or More And Which Are Sold On At Least 33% Of The Car Line. Plus Two Occupants.

★ All Vehicle Height And Ground Clearance Are Measured At the

MVMA Specifications Form

Vehicle Model SPECTRUM

Model Year 1989 Issued 5/10/'88 Revised (e)

METRIC (U.S. Customary)

Vehicle Dimensions See Key Sheets for definitions

All dimensions to ground are for comparative purposes only. Dimensions are to be shown for all base body models of each vehicle line. SAE Ref. no. refers to the definition published in SAE Recommended Practice J1100 "Motor Vehicle Dimensions," unless otherwise specified.

Body Type	SAE Ref. No.	HATCHBACK (JT150FJU)	NOTCHBACK (JT150NJU)
Width			
Tread (front)	W101	1406 (55.4)	
Tread (rear)	W102	1386 (54.6)	
Vehicle width	W103	1616 (63.6)	
Body width at Sg RP (front)	W117	1600 (63.0)	
Vehicle width (front doors open)	W120	3469 (136.6)	3186 (125.4)
Vehicle width (rear doors open)	W121	-	3056 (120.3)
Front fender overall width	W106	1595 (62.8)	
Rear fender overall width	W107	1598 (62.9)	
Turn-in angle (deg.)	W122	21.5°	
Vehicle width including mirrors			

Length

Wheelbase	L101	2400 (94.5)	
Vehicle length	L103	3997 (157.4)	4069 (160.2)
Overhang (front)	L104	815 (32.1)	
Overhang (rear)	L105	782 (30.8)	854 (33.6)
Upper structure length	L123	2657 (104.6)	2394 (94.3)
Rear wheel C/L "X" coordinate	L127	2226 (87.6)	
Cowl point "X" coordinate	L125	155 (6.1)	
Front end length at cantairline	L126	1055 (41.5)	
Rear end length at cantairline	L129	106 (4.2)	441 (17.4)

☆ Height

Passenger destination (front/rear)	P01.23	2/2	-
Trunk/cargo load		56.7 (125)	-
Vehicle height	H101	1320 (52.0)	
Cowl point to ground	H114	915 (36.0)	
Deck point to ground	H138	870 (34.3)	905 (35.6)
Rocker panel-front to ground	H112	172 (6.8)	
Bottom of door closed-front to ground	H133	242 (9.5)	244 (9.6)
Rocker panel-rear to ground	H111	158 (6.2)	
Bottom of door closed-rear to ground	H135	-	
Windshield slope angle	H122	58.1°	
Backlight slope angle	H121	59.4°	50°

☆ Ground Clearance

Front bumper to ground	H102	206 (8.1)	
Rear bumper to ground	H104	195 (7.7)	191 (7.5)
Bumper to ground (front at curb mass (wt.))	H103	228 (9.0)	
Bumper to ground (rear at curb mass (wt.))	H105	281 (11.1)	276 (10.9)
Angle of approach (degrees)	H106	18°	
Angle of departure (degrees)	H107	15°	
Ramp crossover angle (degrees)	H147	13°	
Axle differential to ground (front/rear)	H153	-	
Min. running ground clearance	H156	138 (5.4)	
Location of min. run. gr. clear.		Front Exhaust Pipe	

** All Vehicle Height And Ground Clearance Are Made Using EPA Loaded Vehicle Weight, Loading Conditions.

EPA Loaded Vehicle Weight is the Base Vehicle Weight Plus All Coolant And Fluids Necessary For Operation Plus 100% Of The Fuel Capacity. Plus The Weight Of All Options And Accessories Whic Weigh Three Pounds Or More And Which Are Sold On At Least 33% Of The Car Line. Plus Two Occupants.

☆ All Vehicle Height And Ground Clearance Are Measured At The Manufacturer's Design Load Weight

MVMA Specifications Form

Vehicle Models SPECTRUM

Model Year 1989 Issued 5/10/'88 Revised (e) _____

METRIC (U.S. Customary)

Vehicle Dimensions See Key Sheets for definitions

Body Type

HATCHBACK (JT150FU
JT150FJU)

NOTCHBACK (JT150NU
JT150NJU)

SAE
Ref.
No.

Front Compartment

Sg RP front, "X" coordinate	L31	1095 (43.1)	
Effective head room	H81	965 (38.0)	958 (37.7)
Max. eff. leg room (accelerator)	L34	1060 (41.7)	
SgRP to heel point	H30	265 (10.4)	
SgRP to heel point	L53	850 (33.5)	
Back angle	L40	25°	
Hip angle	L42	95°	
Knee angle	L44	122°	
Foot angle	L46	87°	
Design H-point front travel	L17	194 (7.6)	
Normal driving & riding seat track trvl.	L23	194 (7.6)	
Shoulder room	W3	1340 (52.8)	
Hip room	W5	1340 (52.8)	
Upper body opening to ground	H50	1219 (48.0)	
Steering wheel maximum diameter*	W9	382 (15.0)	
Steering wheel angle	H18	24°	
Accel. heel pt. to steer. whl. ctr	L11	465 (18.3)	
Accel. heel pt. to steer. whl. ctr	H17	639 (25.2)	
Steering wheel to C/L of thigh	H13	83 (3.3)	
Steering wheel torso clearance	L7	367 (14.4)	
Headlining to roof panel (front)	H37	12 (0.5)	19 (0.7)
Undepressed floor covering thickness	H67	25 (1.0)	

Front Compartment Interior Dimensions Are Measured With The Seating Reference Point (SgRP) _____ mm Forward And _____ mm Upward of Rearmost Position.

Rear Compartment

Sg RP Point couple distance	L50	733 (28.9)	
Effective head room	H83	943 (37.1)	955 (37.6)
Min. effective leg room	L51	845 (33.3) / 850 (33.5)	LH/RH
Sg RP (second to heel)	H31	272 (10.7) / 282 (11.1)	LH/RH
Knee clearance	L48	-28 (-1.1)	
Compartment room	L3	645 (25.4)	637 (25.1)
Shoulder room	W4	1340 (52.8)	
Hip room	W6	1113 (43.8)	1080 (42.5)
Upper body opening to ground	H51	-	1220 (48.0)
Back angle	L41	28°	
Hip angle	L43	85°	
Knee angle	L45	95°	
Foot angle	L47	119°	
Headlining to roof panel (second)	H38	26 (1.0)	14 (0.6)
Depressed floor covering thickness	H73	13 (0.5)	

Luggage Compartment

Usable luggage capacity (L (cu. ft.))	V1	-	322 (11.4)
Liftover height	H195	570 (22.4)	567 (22.3)

Interior Volumes (EPA Classification)

Vehicle class		Subcompact cars	
Interior volume index (cu. ft.)		2.877m ³ (101.6)	2.713m ³ (95.8)
Trunk/cargo index (cu. ft.)		0.476m ³ (16.9)	0.322m ³ (11.4)

All linear dimensions are in millimeters (inches).
** EPA Loaded Vehicle Weight, Loading Conditions

☆ All Vehicle Height And Ground Clearance Are Measured At The Manufacturer's Design Load Weight.

MVMA Specifications Form

Vehicle Line SPECTRUM
 Model Year 1989 Issued 5/10/88 Revised (e) _____

METRIC (U.S. Customary)
 Vehicle Dimensions See Key Sheets for definitions

Body Type

HATCHBACK	JT150FU JT150FJU	NOTCHBACK	JT150NU JT150NJU
-----------	---------------------	-----------	---------------------

Station Wagon - Third Seat

SAE
Ref.
No.

Seat facing direction	SD1	
Sg RP couple distance	L85	
Shoulder room	W85	
Hip room	W86	
Effective leg room	L86	
Effective head room	H86	
Sg RP to heel point	H87	
Knee clearance	L87	
Back angle	L88	
Hip angle	L89	
Knee angle	L90	
Foot angle	L91	

Station Wagon - Cargo Space

Cargo length (open front)	L200	
Cargo length (open second)	L201	
Cargo length (closed front)	L202	
Cargo length (closed second)	L203	
Cargo length at belt (front)	L204	
Cargo length at belt (second)	L205	
Cargo width (wheelhouse)	W201	
Rear opening width at floor	W203	
Opening width at belt	W204	
Min. rear opening width above belt	W205	
Cargo height	H201	
Rear opening height	H202	
Tailgate to ground height	H250	
Front seat back to load floor height	H197	
Cargo volume index (m ³ /ft. ³)	V2	
Hidden cargo volume index (m ³ /ft. ³)	V4	
Cargo volume index-rear of 2-seat	V10	

Hatchback - Cargo Space

Cargo length at front seatback height	L208	1269 (50.0)	
Cargo length at floor (front)	L209	1522 (59.9)	
Cargo length at second seatback height	L210	486 (19.1)	
Cargo length at floor (second)	L211	793 (31.2)	
Front seatback to load floor height	H197	449 (17.7)	
Second seatback to load floor height	H198	555 (21.8)	
Cargo volume index (m ³ /ft. ³)	V3	0.840 (29.7)	
Hidden cargo volume index (m ³ /ft. ³)	V4	-	
Cargo volume index-rear of 2-seat	V11	0.476 (16.9)	

Aerodynamics* ○

Wheel lip to ground, front		656 (25.8)	
Wheel lip to ground, rear		657 (25.9)	
Frontal area (m ² /ft. ²)		1.31 (19.5)	
Drag coefficient (Cd)		-	

* EPA Loaded Vehicle Weight, Loading Conditions

○ AT THE CURB WEIGHT.

MVMA Specifications Form
METRIC (U.S. Customary)

Vehicle Line SPECTRUM
 Model Year 1989 Issued 5/10/'88 Revised (*) _____

Body Type

ALL MODEL

Vehicle Fiducial Marks

Fiducial Mark Number*	Define Coordinate Location										
Front	The center of the hole (Ø15) on the front side member.										
Rear	The center of the hole (Ø20) on the rear side member. (Note: The rearmost one of the drain holes.)										
Fiducial Mark Number											
Front	<table border="1"> <tr><td>W21°</td><td>490</td></tr> <tr><td>L54°</td><td>1400</td></tr> <tr><td>H81°</td><td>497</td></tr> <tr><td>H161°</td><td>335 (13.2)</td></tr> <tr><td>H163°</td><td>314 (12.4)</td></tr> </table>	W21°	490	L54°	1400	H81°	497	H161°	335 (13.2)	H163°	314 (12.4)
W21°	490										
L54°	1400										
H81°	497										
H161°	335 (13.2)										
H163°	314 (12.4)										
Rear	<table border="1"> <tr><td>W22°</td><td>500</td></tr> <tr><td>L55°</td><td>4765</td></tr> <tr><td>H82°</td><td>548</td></tr> <tr><td>H162°</td><td>399 (15.7)</td></tr> <tr><td>H164°</td><td>318 (12.5)</td></tr> </table>	W22°	500	L55°	4765	H82°	548	H162°	399 (15.7)	H164°	318 (12.5)
W22°	500										
L55°	4765										
H82°	548										
H162°	399 (15.7)										
H164°	318 (12.5)										

* Reference - SAE Recommended Practice, J162, Motor Vehicle Fiducial Marks.

All linear dimensions are in millimeters (Inches).

** EPA Loaded Vehicle Weight, Loading Conditions

* At Design Load Weight

MVMA Specifications Form

METRIC (U.S. Customary)

Exterior Vehicle And Body Dimensions - Key Sheet

Exterior Width

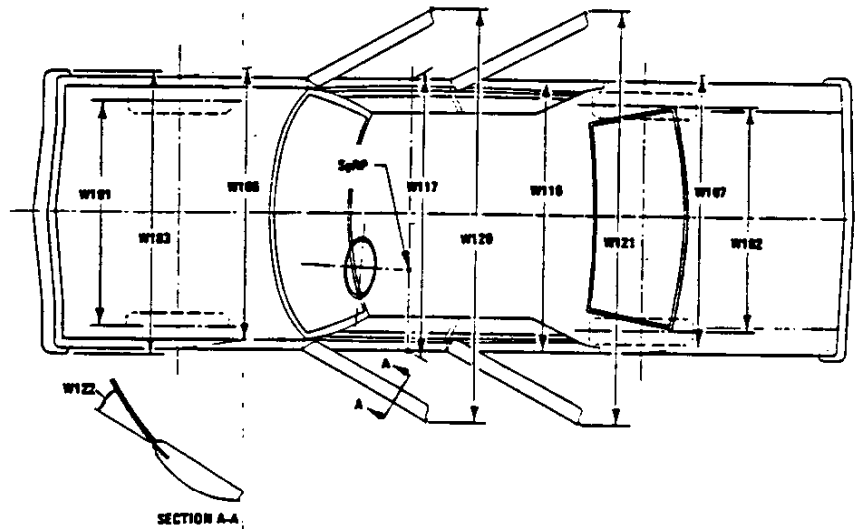

Exterior Length & Height

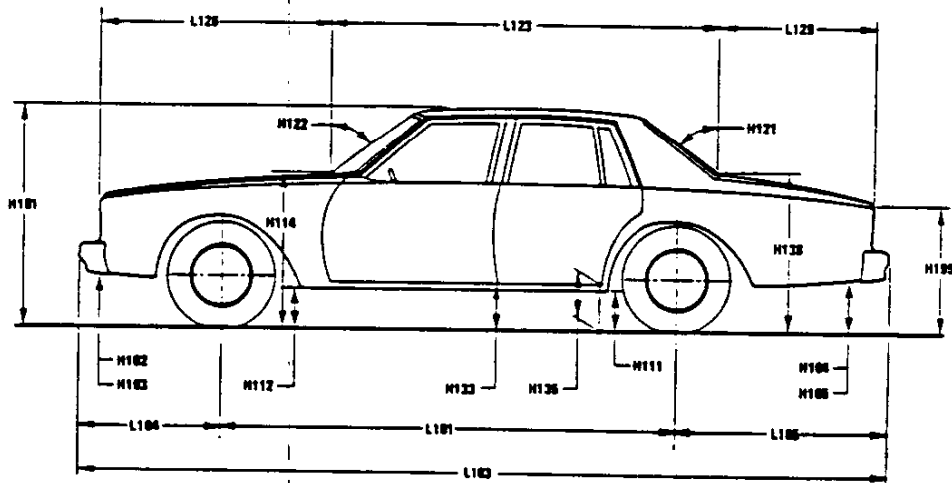

Exterior Ground Clearance

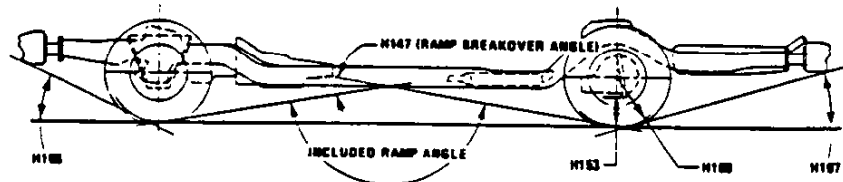

MVMA Specifications Form

METRIC (U.S. Customary)

Interior Vehicle And Body Dimensions - Key Sheet

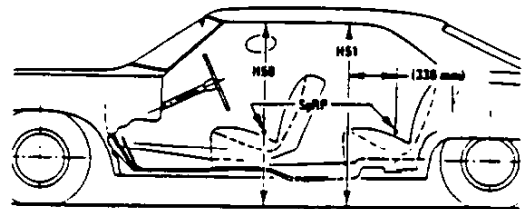
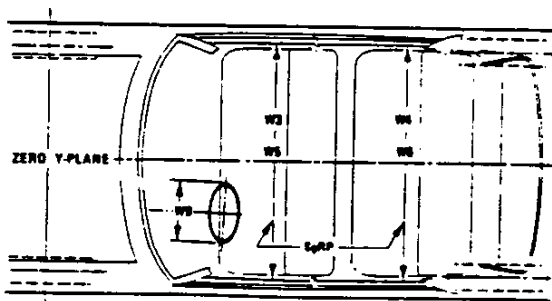
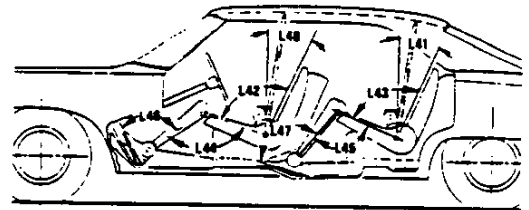
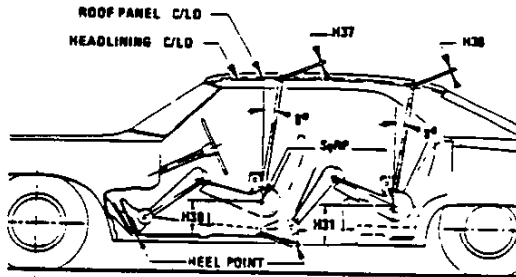
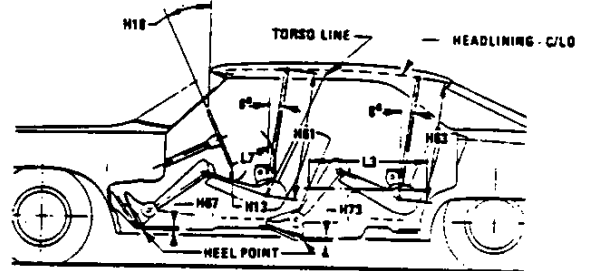
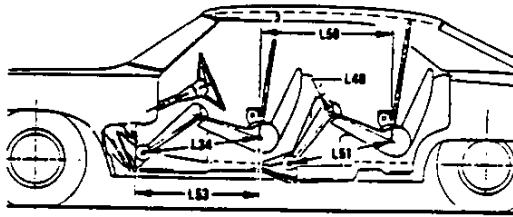

MVMA Specifications Form

METRIC (U.S. Customary)

Interior Vehicle And Body Dimensions – Key Sheet

Third Seat

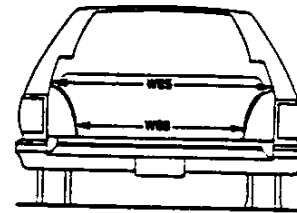
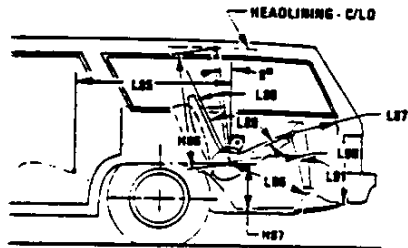

Cargo Space

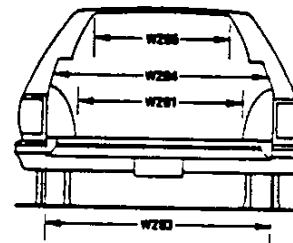
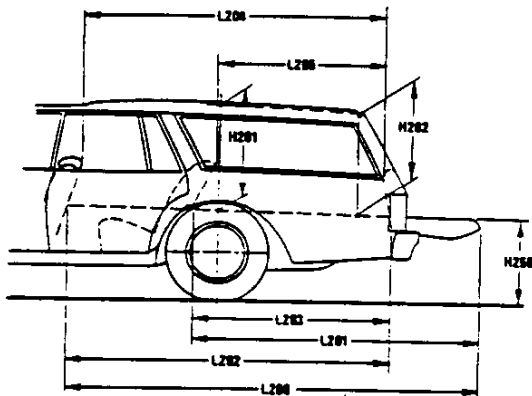

Station Wagon

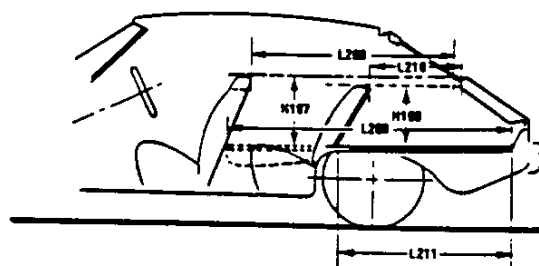

Hatchback

MVMA Specifications Form

METRIC (U.S. Customary)

Exterior Vehicle And Body Dimensions - Key Sheet Dimensions Definitions

Seating Reference Point

SEATING REFERENCE POINT means the manufacturer's design reference point which -

- (a) Establishes the rearmost normal design driving or riding position of each designated seating position in a vehicle;
- (b) Has coordinates established relative to the design vehicle structure;
- (c) Simulates the position of the pivot center of the human torso and thigh; and
- (d) Is the reference point employed to position the two dimensional templates described in SAE Recommended Practice J826, "Devices for Use in Defining and Measuring Vehicle Seating Accommodations."

Width Dimensions

- W101 TREAD-FRONT. The dimension measured between the tire centerlines at the ground.
- W102 TREAD-REAR. The dimension measured between the tire centerlines at the ground. In case of dual wheels, the dimension will be measured to the centerline of tire and wheel assemblies.
- W103 VEHICLE WIDTH. The maximum dimension measured between the widest point on the vehicle, excluding exterior mirrors, flexible mud flaps, marker lamps, but including bumpers, moldings, sheet metal protrusions or dual wheels, if standard equipment.
- W106 FRONT FENDER WIDTH. The dimension measured between the widest points at the front wheel centerline, excluding moldings.
- W107 REAR FENDER WIDTH. The dimension measured between the widest points at the rear wheel centerline, excluding moldings.
- W117 BODY WIDTH AT SgRP-FRONT. The dimension measured laterally between the widest points on the body at the SgRP-front, excluding door handles, applied moldings, or appliques.
- W120 VEHICLE WIDTH-FRONT DOORS OPEN. The dimension measured between the widest point on the front doors in maximum hold-open position.
- W121 VEHICLE WIDTH-REAR DOORS OPEN. The dimension measured between the widest point on the rear doors in maximum hold-open position. For vehicles with a rear door on only one side, this dimension is to the zero "Y" plane.
- W122 TUMBLE-HOME, STRAIGHT SIDE GLASS. The angle measured from a vertical to the outside surface of the front door glass at the SgRP "X" plane.
CURVED SIDE GLASS. The angle measured from a vertical to a chord extending from the upper DLO to the lower DLO at the outside surface of the front door glass at the front SgRP "X" plane.

Length Dimensions

- L101 WHEELBASE (WB). The dimension measured longitudinally between front and rear wheel centerlines. In case of dual rear axles, the dimension shall be to the midpoint of the centerlines of the rear wheels.
- L103 VEHICLE LENGTH. The maximum dimension measured longitudinally between the foremost point and the rearmost point on the vehicle, including bumper, bumper guards, tow hooks and/or rub strips, if standard equipment.
- L104 OVERHANG-FRONT. The dimension measured longitudinally from the centerline of the front wheels to the foremost point on the vehicle including bumper, bumper guards, tow hooks and/or rub strips, if standard equipment.
- L105 OVERHANG-REAR. The dimension measured longitudinally from the centerline of the rear wheels; or in the case

of dual rear axles, the dimension shall be the midpoint of the centerlines of the rear wheels, to the rearmost point on the vehicle including rear bumpers, bumper guards, tow hooks and rub strips, if standard equipment.

- L123 UPPER STRUCTURE LENGTH. The dimension measured longitudinally from the cowl point to the deck point.
- L125 COWL POINT "X" COORDINATE.
- L126 FRONT END LENGTH. The dimension measured longitudinally from the cowl point to the foremost point on the vehicle at the zero "Y" plane excluding ornamentation or bumpers. In cases where bumpers and/or grills are integrated with the profile, measurement is made at the foremost point of front end contour.
- L127 REAR WHEEL CENTERLINE "X" COORDINATE or in the case of dual rear axles, the coordinate shall be the midpoint of the distance between the rear axle centerlines.
- L129 REAR END LENGTH. The dimension measured longitudinally from the deck point to the rearmost visible point of the body sheet metal at the zero "Y" plane, excluding ornamentation or bumpers.

Height Dimensions

- H101 VEHICLE HEIGHT. The dimension measured vertically from the highest point on the vehicle body to ground.
- H111 ROCKER PANEL-REAR TO GROUND. The dimension measured vertically from the bottom of the rocker or side quarter panel at the front of the rear wheel opening, excluding flanges, to ground.
- H112 ROCKER PANEL-FRONT TO GROUND. The dimension measured vertically from the foremost point on the bottom of the rocker panels, excluding flanges, to ground.
- H114 COWL POINT TO GROUND. Measured at zero "Y" plane.
- H121 BACKLIGHT SLOPE ANGLE. The angle between the vertical reference line and the surface of backlight at vehicle zero "Y" plane. For curve backlight, the angle is to chord of backlight arc from lower DLO to upper DLO.
- H122 WINDSHIELD SLOPE ANGLE. The angle between the vertical reference line and a chord of the windshield arc running from the lower DLO to the upper DLO at the vehicle zero "Y" plane. In the case of wrap over glass, the angle to be measured will be formed by a chord 457 mm (18.0 in) long drawn from the lower DLO to the intersecting point on the windshield.
- H133 BOTTOM OF DOOR CLOSED-FRONT TO GROUND. The dimension measured vertically from the bottom outside corner of the door on the lock pillar side, in maximum closed position, to ground.
- H135 BOTTOM OF DOOR CLOSED-REAR TO GROUND. The dimension measured vertically from the bottom outside corner of the door on the lock pillar side, in maximum closed position, to ground.
- H138 DECK POINT TO GROUND. Measured at zero "Y" plane.
- H109 STATIC LOAD-TIRE RADIUS-REAR. Specified by the manufacturer in accordance with composite TIRE SECTION STANDARD.

Ground Clearance Dimensions

- H102 FRONT BUMPER TO GROUND. The minimum dimension measured vertically from the lowest point on the front bumper to ground, including bumper guards, if standard equipment.
- H103 FRONT BUMPER TO GROUND-CURB MASS (WT.). Measured in the same manner as H102.

MVMA Specifications Form

METRIC (U.S. Customary)

Interior Vehicle And Body Dimensions - Key Sheet Dimensions Definitions

- H104 REAR BUMPER TO GROUND. The minimum dimension measured vertically from the lowest point on the rear bumper to ground, including bumper guards, if standard equipment.
- H105 REAR BUMPER TO GROUND - CURB MASS (WT.). Measured in the same manner as H104.
- H106 ANGLE OF APPROACH. The angle measured between a line tangent to the front tire static loaded radius arc and the initial point of structural interference forward of the front tire to ground. The limiting structural component shall be designated.
- H107 ANGLE OF DEPARTURE. The angle measured between a line tangent to the rear tire static loaded radius arc and the initial point of structural interference rearward of the rear tire to ground. The limiting component shall be designated.
- H147 RAMP BREAKOVER ANGLE. The angle measured between two lines tangent to the front and rear tire static loaded radius and intersecting at a point on the underside of the vehicle which defines the largest ramp over which the vehicle can roll.
- H153 REAR AXLE DIFFERENTIAL TO GROUND. The minimum dimension measured from the rear axle differential to ground.
- H156 MINIMUM RUNNING GROUND CLEARANCE. The minimum dimension measured from the sprung vehicle to ground. Specify location.

Glass Areas

- S1 Windshield area.
- S2 Side windows area. Includes the front door, rear door, vents, and rear quarter windows on both sides of the vehicle.
- S3 Backlight areas.
- S4 Total area. Total of all areas (S1 + S2 + S3).

Fiducial Mark Dimensions

- Fiducial Mark - Number 1
- L54 "X" coordinate.
- W21 "Y" coordinate.
- H81 "Z" coordinate.
- H161 Height "Z" coordinate to ground at curb weight.
- H163 Height "Z" coordinate to ground.
- Fiducial Mark - Number 2
- L55 "X" coordinate.
- W22 "Y" coordinate.
- W82 "Z" coordinate.
- H162 Height "Z" coordinate to ground at curb weight.
- H164 Height "Z" coordinate to ground.

Front Compartment Dimensions

- L7 STEERING WHEEL TORSO CLEARANCE. The minimum dimension measured in the side view from the rearmost edge of the steering wheel, with front wheels in the straight ahead position, to the torso line.
- L11 ACCELERATOR HEEL POINT TO STEERING WHEEL CENTER. The dimension measured horizontally from the AHP to the intersection of the steering column centerline and a plane tangent to the upper surface of the steering wheel rim.
- L17 DESIGN H-POINT-FRONT TRAVEL. The dimension measured horizontally between the design H-point-front in the foremost and rearmost seat track positions. (See SAE J1100)
- L23 NORMAL DRIVING AND RIDING SEAT TRACK TRAVEL. The dimension measured horizontally between a point on the design H-point travel line from the SgRP to the displaced point on the design H-point travel line with the seat moved to the foremost seat position, but not to include seat track travel used for purposes other than normal driving and riding positions. (See SAE J1100)

- L31 SgRP-FRONT. "X" COORDINATED.
- L34 MAXIMUM EFFECTIVE LEG ROOM-ACCELERATOR. The dimension measured along a line from the ankle pivot center to the SgRP-front plus 254 mm (10.0 in) measured with right foot on the undepressed accelerator pedal. For vehicles with SgRP to heel (H30) greater than 18 in., the accelerator pedal may be depressed as specified by the manufacturer. If the accelerator is depressed, the manufacturer shall place foot flat on pedal and note the depression of the pedal.
- L-40 BACK ANGLE-FRONT. The angle measured between a vertical line through the SgRP-front and the torso line. If the seatback is adjustable, use the normal driving and riding position specified by the manufacturer.
- L-42 HIP ANGLE-FRONT. The angle measured between torso line and thigh centerline.
- L44 KNEE ANGLE-FRONT. The angle measured between thigh centerline and lower leg centerline measured on the right leg.
- L46 FOOT ANGLE-FRONT. The angle measured between the lower leg centerline and a line tangent to the ball and heel of the bare foot flesh line measured on the right leg. Ref SAE J828.
- L53 SgRP-FRONT TO HEEL. The dimension measured horizontally from the SgRP-front to the accelerator heel point.
- W3 SHOULDER ROOM-FRONT. The minimum dimension measured laterally between the trimmed surfaces on the "X" plane through the SgRP-front at height between the belt line and 254 mm (10.0 in.) above the SgRP-front, excluding the door assist strap and attaching parts.
- W5 HIP ROOM-FRONT. The minimum dimension measured laterally between the trimmed surfaces on the "X" plane through the SgRP-front within 25 mm (1.0 in.) below and 76 mm (3.0 in.) above the SgRP-front and 76 mm (3.0 in.) fore and aft of the SgRP-front.
- W9 STEERING WHEEL MAXIMUM OUTSIDE DIAMETER. Define if other than round.
- H13 STEERING WHEEL TO CENTERLINE OF THIGH. The minimum dimension measured from the bottom of steering wheel, with front wheels in the straight position, to the thigh centerline.
- H17 ACCELERATOR HEEL POINT TO THE STEERING WHEEL CENTER. The dimension measured vertically from the AHP-front to the intersection of the steering column centerline to a plane tangent to the upper surface of the steering wheel rim.
- H18 STEERING WHEEL ANGLE. The angle measured from a vertical to the surface plane of the steering wheel.
- H30 SgRP-FRONT TO HEEL. The dimension measured vertically from the SgRP-front to the accelerator heel point.
- H37 HEADLINING TO ROOF PANEL-FRONT. The dimension measured from the intersection of the headlining and the extended effective head room line normal to the sheet metal.
- H50 UPPER BODY OPENING TO GROUND-FRONT. The dimension measured vertically from the trimmed body opening to the ground on the SgRP-front "X" plane.
- H61 EFFECTIVE HEAD ROOM-FRONT. The dimension measured along a line 8 deg. rear of vertical from the SgRP-front to the headlining plus 102 mm (4.0 in.).
- H67 FLOOR COVERING THICKNESS-UNDEPRESSED-FRONT. The dimension measured vertically from the surface of the undepressed floor covering to the underbody sheet metal at the accelerator heel point.

Rear Compartment Dimensions

- L3 COMPARTMENT ROOM-SECOND. The dimension measured horizontally from the back of the front seat to the front of the second seatback at a height tangent to the top of the second seat cushion.

MVMA Specifications Form

METRIC (U.S. Customary)

Interior Vehicle And Body Dimensions - Key Sheet Dimensions Definitions

- L-41 BACK ANGLE-SECOND. The angle measured between a vertical line through the SgRP-second and the torso line.
- L43 HIP ANGLE-SECOND. The angle measured between torso line and thigh centerline.
- L45 KNEE ANGLE-SECOND. The angle measured between thigh centerline and lower leg centerline.
- L47 FOOT ANGLE-SECOND. The angle measured between the lower leg centerline and a line tangent to the ball and heel of the three-dimensional devices bare foot flesh line (Reference J826).
- L48 KNEE CLEARANCE-SECOND. The minimum dimension measured from the knee pivot center to the back of the front seatback minus 51 mm (2.0 in.).
- L50 SgRP COUPLE DISTANCE-SECOND. The dimension measured horizontally from the driver SgRP-front to the SgRP-second.
- L51 MINIMUM EFFECTIVE LEG ROOM-SECOND. The dimension measured along a line from the ankle pivot center to the SgRP-second plus 254mm (10.0 in.).
- W4 SHOULDER ROOM-SECOND. The minimum dimension measured laterally between door or quarter trimmed surfaces on the "X" plane through the SgRP-second at height between 254-406 mm (10.0-16.0 in.) above the SgRP-second, excluding the door assist straps and attaching parts.
- W6 HIP ROOM-SECOND. Measured in the same manner as W5.
- H31 SgRP-SECOND TO HEEL. The dimension measured vertically from the SgRP-second to the two dimensional device heel point on the depressed floor covering.
- H38 HEADLINING TO ROOF PANEL-SECOND. The dimension measured from the intersection of the headlining and the extended effective head room line normally to the roof sheet metal.
- H51 UPPER BODY OPENING TO GROUND-SECOND. The dimension measured vertically from the trimmed body opening to the ground on the "X" plane 330 mm (13.0 in.) forward of the SgRP-second.
- H63 EFFECTIVE HEAD ROOM-SECOND. The dimension measured along a line 8 deg. rear of vertical from the SgRP to the headlining, plus 102 mm (4.0 in.).
- H73 FLOOR COVERING-DEPRESSED-SECOND. The dimension measured vertically from the heel point to the underbody sheet metal.

Luggage Compartment Dimensions

- V1 USABLE LUGGAGE CAPACITY-Total of volumes of individual pieces of standard luggage set plus H-boxes stowed in the luggage compartment in accordance with the procedure described in paragraph 8.2 of SAE-J1100a.
- H195 LIFTOVER HEIGHT. The dimension measured vertically from the luggage compartment lower opening at the zero "Y" plane to ground.

Interior Volumes (EPA Classification)

The Interior Volume Index is listed for each body style except two seaters. The interior volume index estimates the space in a car. It is based on four measurements - head room, shoulder room, hip room, and leg room - for the front and rear seats, plus trunk capacity. The interior volume index is an estimate of the size of the passenger compartment.

The Trunk/Cargo Index is an estimate of the size of the trunk/cargo space. In station wagons and hatchbacks it is an estimate of the space behind the second seat.

Station Wagon - Third Seat Dimensions

- L85 SgRP COUPLE DISTANCE-THIRD. The dimension measured horizontally from the SgRP-second to the SgRP-third.
- L86 EFFECTIVE LEG ROOM-THIRD. The dimension measured along a line from the ankle pivot center to the SgRP-third plus 254 mm (10.0 in.).
- L87 KNEE CLEARANCE-THIRD. The minimum dimension from the knee pivot center to the back of second seatback minus a constant of 51mm (2.0 in.). With rear-facing third seat, dimension is measured to closure.
- L88 BACK ANGLE-THIRD. Measured in the same manner as L41.
- L89 HIP ANGLE-THIRD. Measured in the same manner as L43.
- L90 KNEE ANGLE-THIRD. Measured in the same manner as L45.
- L91 FOOT ANGLE-THIRD. Measured in the same manner as L47.
- W85 SHOULDER ROOM-THIRD. Measured in the same manner as W4.
- W88 HIP ROOM-THIRD. Measured in the same manner as W5.
- H86 EFFECTIVE HEAD ROOM-THIRD. The dimension, measured along a line 8 deg. from the SgRP-third to the headlining rear of vertical plus a constant of 102 mm (4.0 in.).
- H87 SgRP-THIRD TO HEEL POINT.
- SD1 SEAT FACING DIRECTION-THIRD.

Station Wagon - Cargo Space Dimensions

- L200 CARGO LENGTH-OPEN-FRONT. The minimum dimension measured longitudinally from the back of the front seatback at the height of the undepressed floor covering to the rearmost point on the undepressed floor covering on the open tailgate or cargo surface if the rear closure is a conventional door type tailgate at the zero "Y" plane.
- L201 CARGO LENGTH-OPEN-SECOND. The dimension measured longitudinally from the back of the second seatback at the height of the undepressed floor covering to the rearmost point on the undepressed floor covering on the open tailgate or cargo floor surface if the rear closure is a conventional door type tailgate, at the zero "Y" plane.
- L202 CARGO LENGTH-CLOSED-FRONT. The minimum dimension measured horizontally from the back of the front seat at the height of the undepressed floor covering to the rearmost point on the undepressed floor covering on the closed tailgate or taildoor for station wagons, trucks and mpv's at the zero "Y" plane.
- L203 CARGO LENGTH-CLOSED-SECOND. The dimension measured horizontally from the back of the second seat at the height of the undepressed floor covering to the rearmost point on the undepressed floor covering on the closed tailgate or taildoor for station wagons, trucks and mpv's at the zero "Y" plane.
- L204 CARGO LENGTH AT BELT-FRONT. The minimum dimension measured horizontally from the back of the front seatback at the seatback top to the foremost normal surface of the closed tailgate or inside surface of the cab backpanel at the height of the belt, on the zero "Y" plane.
- L205 CARGO LENGTH AT BELT-SECOND. The minimum dimension measured horizontally from the back of the second seatback at the seatback top to the foremost normal surface of the closed tailgate at the height of the belt, on the zero "Y" plane.
- W201 CARGO WIDTH-WHEELHOUSE. The minimum dimension measured laterally between the trimmed wheelhouseings at floor level. For any vehicle not trimmed, measure to the sheet metal.

MVMA Specifications Form

METRIC (U.S. Customary)

Interior Vehicle And Body Dimensions – Key Sheet Dimensions Definitions

- W203 REAR OPENING WIDTH AT FLOOR. The minimum dimension measured laterally between the limiting interferences of the rear opening at floor level.
- W204 REAR OPENING WIDTH AT BELT. The minimum dimension measured laterally between the limiting interferences of the rear opening at belt height or top of pick up box.
- W205 REAR OPENING WIDTH ABOVE BELT. The minimum dimension measured laterally between the limiting interferences of the rear opening above the belt height.
- H197 FRONT SEATBACK TO LOAD FLOOR HEIGHT. The dimension measured vertically from the horizontal tangent to the top of the seatback to the undepressed floor covering.
- H201 CARGO HEIGHT. The dimension measured vertically from the top of the undepressed floor covering to the headlining at the rear wheel "X" coordinate on the zero "Y" plane.
- H202 REAR OPENING HEIGHT. The dimension measured vertically from the top of the undepressed floor covering to the upper trimmed opening on the zero "Y" plane with rear door fully open.
- H250 TAILGATE TO GROUND CURB MASS (WT.). The dimension measured vertically from the top of the undepressed floor covering on the lowered tailgate to ground on the zero "Y" plane.
- V2 STATION WAGON
Measured in inches:

$$\frac{W4 \times H201 \times L204}{1728} = \text{ft}^3$$
 Measured in mm:

$$\frac{W4 \times H201 \times L204}{10^9} = \text{m}^3 \text{ (cubic meter)}$$
- V4 HIDDEN LUGGAGE CAPACITY—REAR OF FRONT SEAT. The total volumes of individual pieces of one set of standard luggage stowed in any hidden cargo area below the load floor rear of the front seat.
- V5 TRUCKS AND MPV'S WITH OPEN AREA.
Measured in inches:

$$\frac{L506 \times W500 \times H503}{1728} = \text{ft}^3$$
 Measured in mm:

$$\frac{L506 \times W500 \times H503}{10^9} = \text{m}^3 \text{ (cubic meter)}$$
- V6 TRUCKS AND MPV'S WITH CLOSED AREA.
Measured in inches:

$$\frac{L204 \times W500 \times H505}{1728} = \text{ft}^3$$
 Measured in mm:

$$\frac{L204 \times W500 \times H505}{10^9} = \text{m}^3 \text{ (cubic meter)}$$
- V8 HIDDEN LUGGAGE CAPACITY—REAR OF SECOND SEAT. The total volume of individual pieces of one set of standard luggage stowed in any hidden cargo area below the load floor rear of the second seat.
- V10 STATION WAGON CARGO VOLUME INDEX. Usable luggage (one (1) stand and luggage set) below floor:
Measured in inches:

$$\frac{H201 \times L205 \times \frac{W4 + W201}{2}}{1728} = \text{ft}^3$$
 Measured in mm:

$$\frac{H201 \times L205 \times \frac{W4 + W201}{2}}{10^9} = \text{m}^3 \text{ (cubic meter)}$$

Hatchback – Cargo Space Dimensions

All hatchback cargo dimensions are to be taken with the front seat full down and rear position, and the rear seat folded down. The hatchback door is in the closed position. (For electrically adjusted seats, see the manufacturer's specifications for Design "H" Point).

- L208 CARGO LENGTH AT FRONT SEATBACK HEIGHT. The minimum horizontal dimension from the "X" plane tangent to the rearmost surface of the driver's seatback to the inside limiting interference of the hatchback door on the vehicle zero "Y" plane.
- L209 CARGO LENGTH AT FLOOR—FRONT—HATCHBACK. The minimum horizontal dimension measured at floor level from the rear of the front seatback to the normal limiting interference of the hatchback door on the vehicle zero "Y" plane.
- L210 CARGO LENGTH AT SECOND SEATBACK HEIGHT—HATCHBACK. The minimum dimension measured from the "X" plane tangent to the rearmost surface of second seatback or the load floor which is stowed at least one half of the H198 dimension height above the rear load floor, to the rearmost inside limiting interference on the zero "Y" plane.
- L211 CARGO LENGTH AT FLOOR—SECOND HATCHBACK. The minimum horizontal dimension measured at floor level from the rear of the second seatback or load floor panel to the normal limiting interference of the hatchback door on the vehicle zero "Y" plane.
- H197 FRONT SEATBACK TO LOAD HEIGHT. The dimension measured vertically from the horizontal tangent to the top of the seatback to the undepressed floor covering.
- H198 SECOND SEATBACK TO LOAD FLOOR HEIGHT. The dimension measured vertically from the second seat back to the undepressed floor covering.
- V3 HATCHBACK.
Measured in inches:

$$\frac{\frac{L208 + L209}{2} \times W4 \times H197}{1728} = \text{ft}^3$$
 Measured in mm:

$$\frac{\frac{L208 + L209}{2} \times W4 \times H197}{10^9} = \text{m}^3 \text{ (cubic meter)}$$
- V4 HIDDEN LUGGAGE CAPACITY—REAR OF FRONT SEAT. The total volumes of individual pieces of one set of standard luggage stowed in any hidden cargo area below the load floor rear of the front seat.
- V11 HATCHBACK CARGO VOLUME INDEX. Usable luggage (one (1) stand and luggage set) below floor:
Measured in inches:

$$\frac{\frac{L210 + L211}{2} \times W4 \times H198}{1728} = \text{ft}^3$$
 Measured in mm:

$$\frac{\frac{L210 + L211}{2} \times W4 \times H198}{10^9} = \text{m}^3 \text{ (cubic meter)}$$

MVMA Specifications Form

METRIC (U.S. Customary)

Index

Subject	Page No.
Aerodynamics	23
All Wheel Drive	10
Alternator	16
Automatic Transmission/Transaxle	8, 9
Axle, Steering	14
Axle, Drive, Front, Rear, All, Four	2, 9, 10
Axle Shafts	10
Battery	16
Body and Miscellaneous Information	17
Brakes—Parking, Service	12, 13
Camber	15
Camshaft	3
Capacities	
Cooling System	5
Fuel Tank	6
Lubricants	
Engine Crankcase	4
Transmission/Transaxle	8, 9
Rear Axle	10
Carburetor	2, 6
Caster	15
Clutch - Pedal Operated	8
Coil, Ignition	16
Connecting Rods	4
Convenience Equipment	19-20
Cooling System	5
Crankshaft	4
Cylinders and Cylinder Head	3
Diesel Information	4
Dimension Definitions	
Key Sheet - Exterior	27, 30, 31
Key Sheet - Interior	28, 29, 31, 32, 33
Electrical System	15, 16
Emission Controls	7
Engine—General	
Bore, Stroke, Type	3
Compression Ratio	2
Displacement	2, 3
Firing Order, Cylinder Numbering	3
General Information, Power & Torque	2
Intake System	4
Power Teams	2
Exhaust System	7
Equipment Availability, Convenience	19
Fan, Cooling	5
Filters - Engine Oil, Fuel System	4
Four Wheel Drive	10
Frame	18
Front Suspension	11
Front Wheel Drive Unit	10
Fuel System	6
Fuel Injection	6
Fuel Tank	6
Glass	18
Headlamps	18
Headroom - Body	22, 23
Heights	21
Horns	15
Horsepower - Brake	2
Ignition System	16
Inflation - Tires	13
Interior Volumes	22
Instruments	15
Lagroom	22, 23
Lengths	21
Leveling, Suspension	11
Lifters, Valve	4
Linings - Clutch, Brake	8, 12
Lubrication - Engine Transmission/Transaxle	4, 8, 9
Luggage Compartment	22
Models	1
Motor Starting	16
Muffler	7

Subject	Page No.
Origin	1
Passenger Capacity	1
Passenger Mass Distribution	25
Pistons	3
Power Brakes	12
Power, Engine	2
Power Steering	14
Power Teams	2
Propeller Shaft, Universal Joints	10
Pumps - Fuel	6
Water	5
Radiator - Cap, Hoses, Core	5
Ratios - Axle, Transaxle	2, 9
Compression	2
Steering	14
Transmission/Transaxle	2, 8, 9
Rear Axle	2, 9, 10
Regulator - Alternator	16
Restraint System	18
Rims	13
Rods - Connecting	4
Scrub Radius	14
Seats	17
Shock Absorbers, Front & Rear	11
Spark Plugs	16
Speedometer	15
Springs - Front & Rear Suspension	11
Stabilizer (Sway Bar) - Front & Rear	11
Starting System	16
Steering	14
Suppression - Ignition, Radio	16
Suspension - Front & Rear	11
Tail Pipe	7
Theft Protection	20
Thermostat, Cooling	5
Tires	13
Toe-In	15
Torque Converter	9
Torque - Engine	2, 8, 9
Transaxle	9
Transmission - Types	2, 8, 9
Transmission - Automatic	2, 8, 9
Transmission - Manual	2, 8, 9
Transmission - Ratios	2, 9
Tread	21
Trunk Cargo Load	1
Trunk Luggage Capacity	22
Turning Diameter	14
Unitized Construction	18
Universal Joints, Propeller Shaft	10
Valve System	4
Vehicle Dimensions	
Width	21
Length	21
Height	21
Ground Clearance	21
Front Compartment	22
Rear Compartment	22
Luggage Compartment	22
Station Wagon - Third Seat	23
Station Wagon - Cargo Space	23
Hatchback - Cargo Space	23
Fiducial Marks	24
Voltage Regulator	16
Water Pump	5
Weights	25, 26
Wheel Alignment	15
Wheelbase	21
Wheels & Tires	13
Wheel Sprinkle	14
Widths	21
Windshield	18
Windshield Wiper and Washer	15

