

1990
CHEVROLET
SEDAN

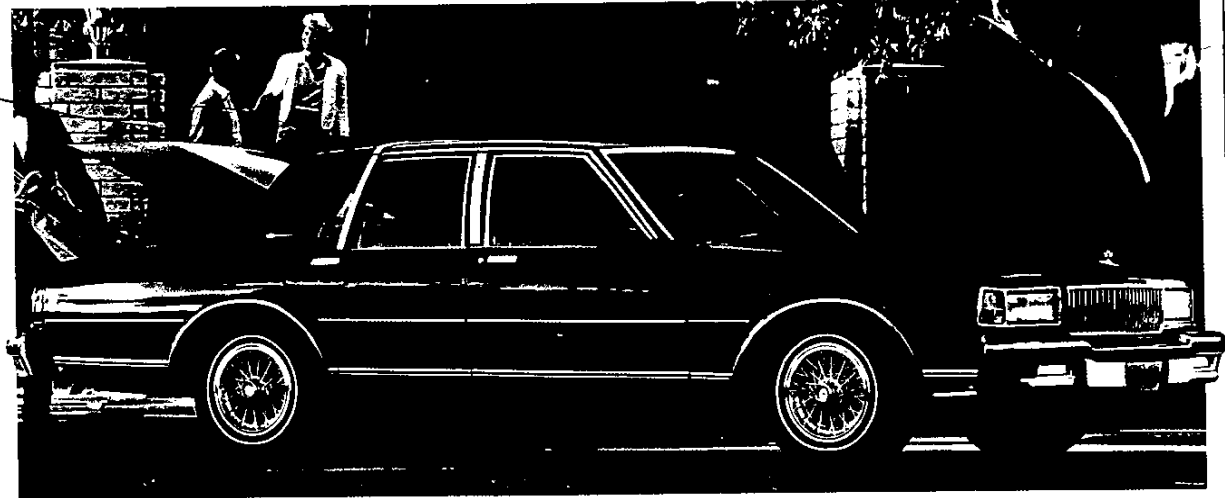

CAPRICE

CAPRICE	MODEL NUMBER	CAPRICE CLASSIC	MODEL NUMBER
4-Door Sedan	1BL69	4-Door Wagon (3-seat)	1BN35
CAPRICE CLASSIC		PASSENGER CAPACITY	
4-Door Sedan	1BN69	Sedans	6
4-Door Brougham Sedan	1BU69	Wagon	8
4-Door Brougham LS Sedan	1BU69/B6N		

Caprice Classic Brougham LS 4-Door Sedan.



HIGHLIGHTS

- Caprice and Caprice Classic model lineup is retained for 1990.
- **Scotchgard™** Fabric Protector applied to interior seat and door cloth fabric.
- New passive front seat belts for driver and front outer passenger.
- Bar code vehicle identification number added to visible alphanumeric VIN plate.
- Two new exterior colors—Dark Red Metallic and Dark Maroon Metallic—are available.
- One new interior color, Maroon, is available.
- A black vinyl glove box portfolio, embossed with the Chevrolet bowtie, has slots for the Owner's Manual, Warranty Book and business cards.
- Front disc brake shoes are of a new material and are equipped with a new insulator designed to reduce brake noise.
- Roomy full-size rear-drive comfort and ride.

EQUIPMENT AVAILABILITY

Chrome-plated grille	S	S	S	S
Composite halogen headlamps	S	S	S	S
Bumper rub strips	NA	S	S	S
Bright wide lower body moldings	NA	S	S	S
Bright lower body-sill moldings	S	NA	NA	NA
Bright roof drip molding	S	S	S	S
Full padded vinyl roof cover	NA	O	O	NA
LS formal roof treatment	NA	NA	O	NA
Wheel-opening moldings	O	S	S	S
Custom wheel covers	O	O	S	O
Dual sport mirrors (left-hand remote)	S	S	S	S
Tinted glass	S	S	S	S
Front seat folding center armrest	S	S	S	S
Rear seat folding center armrest	NA	NA	S	NA
Simulated wood-grain instrument panel accents	S	S	S	S
AM/FM stereo radio with Seek and Scan and digital clock	S*	S*	S*	S*
Air conditioning	S	S	S	S
Color-coordinated safety belt system with passive front restraints at outer positions, lap/shoulder belts at rear outer position and lap belts at center positions	S	S	S	St
Headlamps-on reminder	S	S	S	S
Color-keyed carpeting	S	S	S	S
Quiet Sound Group	NA	S	S	S
4-speed automatic with overdrive	S	S	S	S
P205/75R-15 all-season steel-belted blackwall radial tires	S	S	S	NA
P225/75R-15 all-season steel-belted white-stripe radial tires	NA	NA	NA	S

S—Standard. O—Optional at Extra Cost. NA—Not Available. *May be deleted for credit from Base Vehicle Groups only. †Includes lap belts for rear-facing third seat.

Refer to Passenger Car Order Guide for option availability and application.

ORDERING INFORMATION

PREFERRED EQUIPMENT GROUPS

NOTE: NOT TO BE USED FOR ORDERING. REFER TO ORDER GUIDE FOR CURRENT USAGE AND AVAILABILITY.

DESCRIPTION	CAPRICE SEDAN		CAPRICE CLASSIC SEDAN		CAPRICE CLASSIC BROUHAM		CAPRICE CLASSIC BROUHAM LS		CAPRICE CLASSIC WAGON		
	P.E.G. 1	P.E.G. 2	P.E.G. 1	P.E.G. 2	P.E.G. 1	P.E.G. 2	P.E.G. 1	P.E.G. 2	P.E.G. 1	P.E.G. 2	P.E.G. 3
AM/FM Stereo w/Cassette, Digital Clock & ERS	0	0	0	X*	0	X*	X*		0	X*	
AM/FM Stereo w/Cassette, Equalizer, Digital Clock & ERS	0	0	0	0	0	0	0	X	0	0	X
Extended Range (dual rear) Speakers	X	X	X	X	X	X	X	X			
Carpeted Floor Mats, Carpeted Front/Rear	X	X	X	X	X	X	X	X		X	X
Body-Side Moldings	X	X	X	X	X	X	X	X	X	X	X
Wheel-Opening Moldings	X	X	STD.	STD.	STD.	STD.	STD.	STD.	STD.	STD.	STD.
Power Door Lock System	0	X	0	X	0	X	X	X	0	X†	X†
Auxiliary Lighting		X	X	X	STD	STD.	STD.	STD.	X	X	X
Intermittent Wiper System		X						X			X
Comfortilt Steering Wheel		X		X			X	X	X		X
Electronic Speed Control		X	X	X			X	X	X		X
Power Windows				X			X	X			X
Power Seats, 6-Way (Driver/Pass.)							X	X			X
Power Trunk Release			X	X	X	X	X				
Deluxe Luggage Compartment Trim				X			X		X		
Gage Package with Trip Odometer					X	X	X	X			X
Twilight Sentinel Headlamps					X	X	X	X			X
Cornering Lamps							X		X		X
Illuminated Visor Mirror, RH				X	X	X	X	X			X
Sport Mirrors, Iwin Remote			X	X	X	X	X	X	X	X	X
Deluxe Load Floor Carpeting									X	X	X
Roof Carrier										X	X
Deluxe Rear Compartment Decor											X
P205/75R-15 White-Stripe Tires			X	X	X	X	X	X	STD.	STD.	STD.
Wire Wheel Covers w/Locks			0	0	0	X	X	X	0	0	0
INDIVIDUAL OPTIONS											
Tires/Wheel Trim											
P205/75R-15 White-Stripe Tires	0		0		X**	X**	X**	X**			
P225/70R-15 White-Stripe Tires (Reqs. F41 Suspension)			0		0		0			STD.	
Custom Wheel Covers	0		0		STD.		STD.			0	
Wire Wheel Covers w/Locks			0		0	X	X	X		0	
Climate Control											
Electric Rear Window Defogger	0		0		0		0			0	
Engine Block Heater	0		0		0		0			0	
Radio Equipment											
AM/FM Stereo w/Cassette, Digital Clock & ERS	0		0	X	0	X	X		0	X	
AM/FM Stereo w/Cassette, Equalizer, Digital Clock & ERS	0		0		0		0	X	0	0	X
Radio Delete	Available only with Base Vehicle Groups.										
Additional Individual Options											
Perf. Ratio Axle (3.08 Sedans, 3.23 Wagon)	0		0		0		0			0	
Limited Slip Differential Rear Axle	0		0		0		0			0	
Heavy-Duty Cooling	0		0		0		0			0	
Heavy-Duty Suspension	0		0		0		0			STD.	
Sport Suspension			0		0		0				
Power Door Lock System	0	X	0	X	0	X	X	X	0†	X†	X†
Rear Air Deflector										0	0
Front License Plate Bracket	0		0		0		0			0	
Trunk Cargo Net	0		0		0		0				
Estate Equipment										0	
Inflatable Rear Shock Absorbers										0	
Custom Two-Tone Paint			0		0					0	
Body Pin Striping			0		0		0			0	

X-Included in P.E.G. STD.-Standard. 0-Available Individual Option. ERS-Extended Range Sound System.
 *May be upgraded. †Includes tailgate lock. **Also available as an Individual Option with Base Vehicle Group.

Refer to Passenger Car Order Guide for option availability and application.

SEAT TYPES & COLORS

CAPRICE CLOTH SEAT TRIM & VINYL SEAT TRIM



Standard cloth seat trim available in Dark Blue, Light Brown, Gray or Maroon.

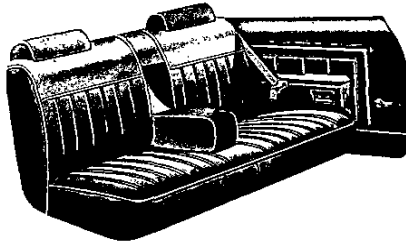

Standard cloth bench seat with pull-down center armrest and adjustable head restraints.

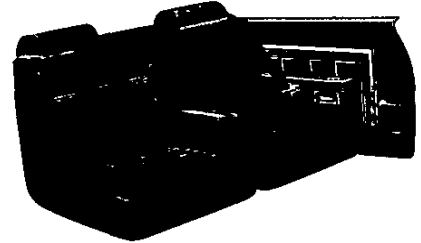

Optional cloth 50/50 seat with twin pull-down center armrests, adjustable head restraints and reclining* seat-backs.



Optional vinyl seat trim available in Dark Blue, Light Brown, Gray or Maroon.

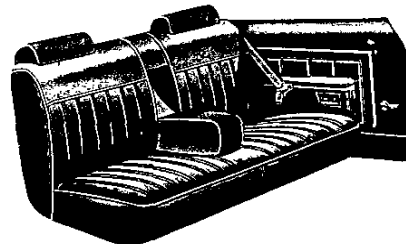

Optional vinyl bench seat with pull-down center armrest and adjustable head restraints. Also available for Caprice Classic Wagon (with cloth door panels).

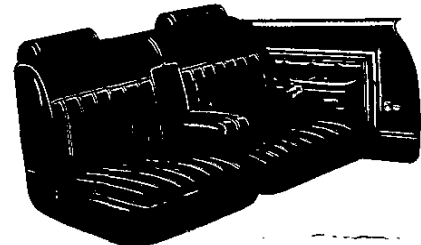

Optional vinyl 50/50 seat with twin pull-down center armrests, adjustable head restraints and reclining* seat-backs. Also available (with cloth door panels) for Caprice Classic Wagon.

CAPRICE CLASSIC CLOTH SEAT TRIM



Standard cloth seat trim available in Dark Blue, Light Brown, Gray or Maroon.

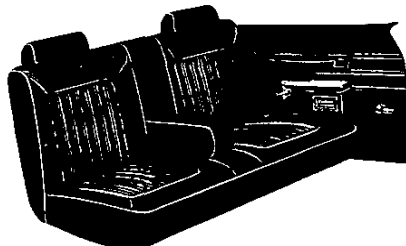

Standard cloth bench seat with pull-down center armrest and adjustable head restraints. Padded door panels with pull straps, bright handle recesses and carpeted lowers.

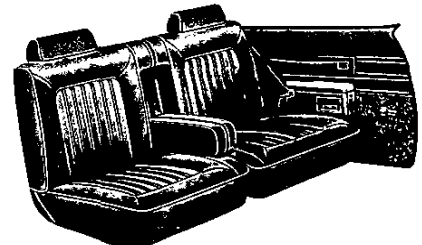

Optional cloth 50/50 seat with twin pull-down center armrests, adjustable head restraints and reclining* seat-backs.

BROUGHAM & BROUGHAM LS CLOTH SEAT TRIM & OPTIONAL LEATHER SEATING SURFACES



Standard cloth seat trim available in Dark Blue, Light Brown, Gray or Maroon.



Optional leather seat trim available in Dark Blue, Light Brown, Gray or Maroon.



Standard cloth 45/55 front seat with center armrest, adjustable head restraints and reclining* seat-backs; padded-cloth door panels. Also available with leather seating surfaces (with vinyl door panels).

Refer to Passenger Car Order Guide for option availability and application.

*For driver and passenger.

WHEEL TRIM

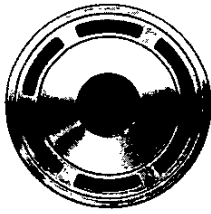

Standard Caprice and Caprice Classic Full Wheel Covers.

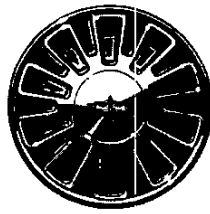

Custom Wheel Covers (RPO PB2), standard on Caprice Classic Brougham models, available all others.

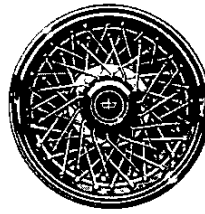

Optional Wire Wheel Covers with locks (RPO N91) available all Caprice Classic models.

RADIOS



Standard electronically tuned AM/FM stereo radio* with Seek and Scan, digital clock and dual front and dual rear speakers.

*May be deleted for credit from Base Vehicle Groups only.



Optional electronically tuned AM/FM stereo radio with Seek and Scan, digital clock, stereo cassette tape player and dual front and dual rear speakers (RPO UM6).



Optional electronically tuned AM/FM stereo radio with Seek and Scan, graphic equalizer, stereo cassette tape player, digital clock and ERS™ (Extended Range Sound System) (RPO UU6).

Appearance of radios may vary by car model.

VALUE FEATURES

Caprice and Caprice Classic models include many standard features that enhance operation, safety and convenience. For 1990, these include:

- 5.0 Liter V8 power.
- Automatic transmission.
- Air conditioning.
- Power front disc/rear drum brakes.
- Power steering.
- Full perimeter frame.
- Full coil suspension system.
- **Scotchgard™** Fabric Protector.

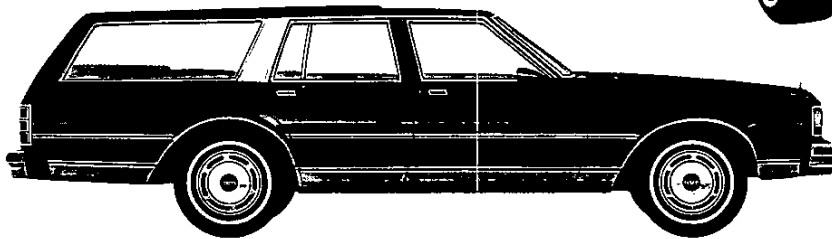
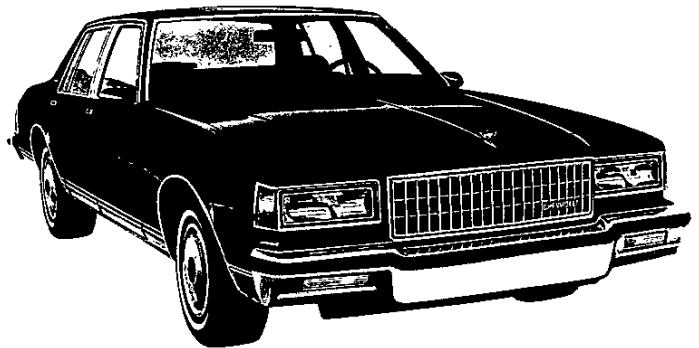

©1989 General Motors Corporation. All rights reserved. The Chevrolet emblem is a registered trademark of General Motors Corporation.

All illustrations and specifications in this brochure are based on the latest product information available at the time of publication approval. The right is reserved to make changes at any time, without notice, in colors, materials, specifications and models, and also to discontinue models. Chevrolet Motor Division, General Motors Corporation, Warren, Michigan 48090



Refer to Passenger Car Order Guide for option availability and application.

CHEVROLET SPECIFICATIONS — 1990 CAPRICE

MODELS PASSENGERS

Caprice Classic Brougham LS 4-Door Sedan (1BU69/B6N)	6
Caprice Classic Brougham 4-Door Sedan (1BU69) ..	6
Caprice Classic 4-Door Sedan (1BN69)	6
Caprice Classic 4-Door 3-Seat Wagon (1BN35)	8
Caprice 4-Door Sedan (1BL69)	6

DIMENSIONS (inches)

EXTERIOR

Wheelbase	116.0
Length (overall)	Caprice Sedan 212.2
.....	Caprice Classic Sedan 212.8
.....	Caprice Classic Wagon 215.7
Width (overall)	Sedans 75.4
.....	Wagon 79.3

INTERIOR

Head Room-Front/Rear	Caprice Sedan 39.5/38.2
.....	Caprice Classic Sedan 39.3/38.0
.....	Caprice Classic Wagon 39.6/39.3
Shoulder Room-Front/Rear	Caprice Sedan 60.5/60.5
.....	Classic, Brougham Sedans, Wagon 60.9/60.9
Hip Room-Front/Rear	Sedans 55.0/55.3
.....	Wagon 55.1/55.0
Leg Room-Front/Rear	Caprice, Caprice Classic Sedan 42.2/39.1
.....	Caprice Classic Brougham 42.2/38.7
.....	Wagon 42.2/37.2

LUGGAGE/CARGO CAPACITY (cu. ft.)

Luggage Compartment	Sedans 20.9
.....	Wagon, 2nd & 3rd Seat Down 87.9
.....	Wagon, 2nd Seat Up 50.4

RATED FUEL TANK CAPACITY (gallons)

.....	Sedan 24.5
.....	Wagon 22.0

POWER TEAMS

STANDARD ENGINE

- Sedan - RPO L03 5.0 Liter (305 cu. in.) V8 with Electronic Fuel Injection (EFI)
- Wagon - RPO LV2, 5.0 Liter (307 cu. in.) 4-Bbl.V8

STANDARD TRANSMISSION

- 4-Speed Automatic Overdrive

STANDARD EQUIPMENT SUMMARY

Composite Halogen Headlamps with Bright Bezels
 Bright Grille
 Stand-up Caprice Hood Ornament
 15" All-Season Steel-Belted Radial Ply Blackwall Tires (White Stripe Std. on Wagon)
 Air Conditioning
 Full Wheel Covers
 Dual Horns
 Dual Aero Mirrors (L.H. Remote Control)
 Tinted Glass (All Around)
 Simulated Wood Interior Trim Accents
 Serpentine Belt Accessory Drive System (Sedan Engines)
 Passive Front Safety Belt System; Rear Seat Outer Position Lap/Shoulder Belts (Lap Belts at Center Positions)
 Full Molded Foam Front and Rear Seats
 Cloth Headlining
 Nylon Cut-Pile Floor Carpeting
 AM/FM Stereo Radio with Seek and Scan and Digital Clock w/Dual Rear Speakers (May be Deleted for Credit)
 Scotchgard™ Fabric Protector

SEAT STYLES

STANDARD SEATS

- Caprice Sedan - Cloth Bench with Center Armrest and Adjustable Head Restraints
- Caprice Classic Sedan, Wagon - Cloth Bench with Center Armrest and Adjustable Head Restraints
- Caprice Classic Brougham - Cloth 45/55 Seat with Center Armrest, Driver and Passenger Seat Recliners, Adjustable Head Restraints

OPTIONAL SEATS

- Caprice Sedan and Classic Wagon - Vinyl Bench with Center Armrests and Adjustable Head Restraints; Vinyl or Cloth 50/50 Seat with Center Armrest, Adjustable Head Restraints, Driver and Passenger Seat Recliners
- Caprice Classic Sedan - Cloth 50/50 Seat with Twin Armrests, Adjustable Head Restraints, Driver and Passenger Seat Recliners
- Caprice Classic Brougham - 45/55 Seat with Leather Seating Surfaces

CAPRICE CLASSIC BROUGHAM SEDAN LS

COLOR AND TRIM SELECTION

PLEASE NOTE: The Exterior Paint and Interior Trim Combinations Shown Below are the Only Combinations that are Available

Interior Trim Color		Dk Blue	Lt Brown	Gray	Maroon
MODEL	SEAT TYPE				
1BU69	Cloth 45/55	CDD5	CEE5	CQQ5	CFF5
	Leather 45/55	ADD5	AEE5	AQQ5	AFF5

*BROUGHAM LS PAINT APPLICATION AND VINYL ROOF SELECTOR

Exterior Paint Color	Color Code 1	Color Code 2	Dk Blue	Lt Brown	Gray	Maroon
Black	41	41			19T	19T
Blue, Dk (Met)	29	29	29T		29T	
Gray, Medium (Met)	15	15			84T	84T
Maroon, Dk (Met)	79	79			79T	79T
White	40	40	11T	11T	11T	11T

*Vinyl Roof Option Must Be Specified In "Plus" (+) Option Section of Order Worksheet.

BLACK 19T DARK BLUE (MET) 29T WHITE 11T
 MEDIUM GRAY (MET) 84T DARK MAROON (MET) 79T

POWER TEAMS

ENGINE OPTION CONDITION	AXLE RATIO	
	2.73	3.08
WITH NA5 STANDARD EMISSIONS		
L03 MX0	Std	G92
WITH YF5 CALIFORNIA EMISSIONS		
L03 MX0	Std	G92

CAPRICE CLASSIC BROUGHAM SEDAN LS

18,030.00 **Model 1BU69**

PREFERRED VEHICLE

MUST ORDER ONE GROUP — NO DELETIONS ALLOWED

	BUA1	BUA2
2,270.00 Preferred Equipment Group 1		
Electronically Tuned AM/FM Stereo Radio w/Seek-Scan, Stereo Cassette Tape and Digital Clock w/Extended Range Sound System and Power Antenna	x	N/I
Floor Covering: Carpeted Mats, Color-Keyed Front and Rear	x	x
Gage Package w/Trip Odometer	x	x
Mirror: Right Hand Visor, Illuminated	x	x
Mirrors: Sport, Twin Remote	x	x
Moldings, Body Side	x	x
Power Door Lock System	x	x
Power Seats (Passenger/Driver)	x	x
Power Trunk Opener	x	x
Power Windows	x	x
Speed Control: Electronic, with Resume Speed	x	x
Steering Wheel, Comfortilt	x	x
Tires, P205/75R15 W/S	x	x
Twilight Sentinel	x	x
Wheel Trim: Wheel Covers w/Locks, Wire	x	x
Windshield Wiper System, Intermittent	x	x
2,494.00 Preferred Equipment Group 2		
Electronically Tuned AM/FM Stereo Radio w/Seek-Scan, Stereo Cassette Tape, Graphic Equalizer, Digital Clock w/Extended Range Sound System and Power Antenna		x
Lamps, Cornering		x
Luggage Compartment Trim, Deluxe		x

Base Vehicles may be ordered by specifying Preferred Equipment Group Code BUAB (Incls AM/FM Stereo Radio w/Seek-Scan and Digital Clock w/Dual Rear Speakers, 4-Speed Automatic Trans, Custom Wheel Covers, Air Conditioning and 5.0 Liter EFI V8 Eng).

REGIONALIZED OPTIONS

ADDITIONAL OPTIONS MAY BE ORDERED FROM THIS LISTING ONLY

<p>ENGINE (Must Order) N.C. L03 5.0 Liter EFI V8</p> <p>EMISSION (Must Order One) N.C. NA5 Standard Emissions 100.00 YF5 California Emissions</p> <p>TIRES (Must Order One) N.C. QCE P205/75 R15 B/W (Radial) (Base) (Reqs Group BUAB) 76.00 QCG P205/75 R15 W/S (Radial) 188.00 QHJ P225/70 R15 W/S (Radial) (Req F41 Susp)</p> <p>CLIMATE CONTROL 160.00 C49 Defogger, Rear Window: Electric 20.00 K05 Heater, Engine Block</p> <p>RADIO EQUIPMENT V.P.S. --- Electronically Tuned AM/FM Stereo Radio w/Seek-Scan and Digital Clock w/Dual Rear Speakers (Base) V.P.S. UM6 Electronically Tuned AM/FM Stereo Radio w/Seek-Scan, Stereo Cassette Tape and Digital Clock w/Extended Range Sound System and Power Antenna (Incl w/Group BUA1)</p>	<p>V.P.S. UU6 Electronically Tuned AM/FM Stereo Radio w/Seek-Scan, Stereo Cassette Tape, Graphic Equalizer and Digital Clock w/Extended Range Sound System w/Power Antenna (Incl w/Group BUA2)</p> <p>V.P.S. UL5 Radio Delete (Reqs Group BUAB)</p> <p>INTERIOR TRIM N.C. C**5 Cloth 45/55 550.00 A**5 Leather 45/55</p> <p>ADDITIONAL OPTIONS 21.00 G92 Axle, 3.08 Performance 100.00 G80 Axle: Rear, Limited Slip Differential (N/A F41 Suspension) 40.00 V08 Cooling, Heavy-Duty N.C. VK3 License Plate Bracket, Front 215.00 AU3 Power Door Lock System (Incl w/Groups BUA1 and BUA2) 61.00 D85 Striping, Pin: Body 26.00 F40 Suspension, Heavy-Duty (N/A F41 Susp) 49.00 F41 Suspension, Sport (Reqs QHJ Tires and G92 Axle) 30.00 AP9 Trunk Cargo Net</p>
---	---

REVISED: 9-15-89

1990 ORDER GUIDE

CAPRICE
Page 3

Prices Shown Are Manufacturer's Suggested Retail Prices (MSRP) At The Time Of Publication. These Prices Are To Be Used Only As An Aid To Inventory Management Since MSRP Figures Change Periodically. The Vehicle Price Schedule Is The Official Pricing Documentation Of Chevrolet Motor Division And Should Be Used In Discussing Vehicle Prices With Potential Buyers. The Model Prices Shown In The Order Guide Include The Destination Freight Charges.

CAPRICE CLASSIC BROUGHAM SEDAN

COLOR AND TRIM SELECTION

PLEASE NOTE: The Exterior Paint and Interior Trim Combinations Shown Below are the Only Combinations that are Available

Interior Trim Color		Dk Blue	Lt Brown	Gray	Maroon
MODEL	SEAT TYPE				
1B069	Cloth 45/55	CDD5	CEE5	CQQ5	CFF5
	Leather 45/55	ADD5	AEE5	AQQ5	AFF5

CUSTOM TWO-TONE PAINT

(D84 Must be Specified in "Plus" (+) Option Section of Order Worksheet

Exterior Paint Color	Color Code 1	Color Code 2	Vinyl Roof #	Dk Blue	Lt Brown	Gray	Maroon
Black & Med Gray (Met)	41	15	19T			•	
Blue, Dk (Met) & Lt Blue (Met)	29	26	29T	•			
Brown, Lt (Met) & Dk Brown (Met)	57	59	57T		•		
Gray, Medium (Met) & Dk Maroon (Met)	15	79	84T				•
Maroon, Dk (Met) & Dk Red (Met)	79	89	79T				•

#Vinyl Roof Option Must Be Specified In "Plus" (+) Option Section of Order Worksheet.

@SOLID PAINT APPLICATION AND VINYL ROOF SELECTOR

Exterior Paint Color	Color Code 1	Color Code 2	Dk Blue	Lt Brown	Gray	Maroon
Beige	52	52		57T		
Black	41	41			19T	19T
Blue, Dk (Met)	29	29	29T		29T	
Blue, Lt (Met)	26	26	29T			
Brown, Dk (Met)	59	59		57T		
Brown, Lt (Met)	57	57		57T		
Gray, Medium (Met)	15	15			84T	84T
Maroon, Dk (Met)	79	79			79T	79T
Red, Dk (Met)	89	89			79T	79T
White	40	40	11T/29T	11T/57T	11T/84T	11T/79T

@Vinyl Roof Option Must Be Specified In "Plus" (+) Option Section of Order Worksheet.

BLACK 19T DARK BLUE (MET) 29T LIGHT BROWN (MET) .. 57T
 MEDIUM GRAY (MET) 84T DARK MAROON (MET) 79T WHITE 11T

POWER TEAMS

ENGINE OPTION CONDITION	AXLE RATIO	
	2.73	3.08
WITH NA5 STANDARD EMISSIONS		
L03 MX0	Std	G92
WITH YF5 CALIFORNIA EMISSIONS		
L03 MX0	Std	G92

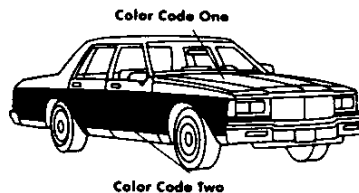

D84 CUSTOM TWO-TONE

CAPRICE CLASSIC BROUGHAM SEDAN

16,830.00 **Model 1BU69**

PREFERRED VEHICLE

MUST ORDER ONE GROUP — NO DELETIONS ALLOWED

	BRA1	BRA2
470.00 Preferred Equipment Group 1		
Extended Range Speakers	x	x
Floor Covering: Carpeted Mats, Color-Keyed Front and Rear	x	x
Gage Package w/Trip Odometer	x	x
Mirror: Right Hand Visor, Illuminated	x	x
Mirrors: Sport, Twin Remote	x	x
Moldings, Body Side	x	x
Power Trunk Opener	x	x
Tires, P205/75R15 W/S	x	x
Twilight Sentinel	x	x
2,384.00 Preferred Equipment Group 2		
Electronically Tuned AM/FM Stereo Radio w/Seek-Scan, Stereo Cassette Tape and Digital Clock w/Extended Range Sound System and Power Antenna		x
Lamps, Cornering		x
Luggage Compartment Trim, Deluxe		x
Power Door Lock System		x
Power Seats (Passenger/Driver)		x
Power Windows		x
Speed Control: Electronic, with Resume Speed		x
Steering Wheel, Comfortilt		x
Wheel Trim: Wheel Covers w/Locks, Wire		x
Windshield Wiper System, Intermittent		x

Base Vehicles may be ordered by specifying Preferred Equipment Group Code BRAB (Incls AM/FM Stereo Radio w/Seek-Scan and Digital Clock w/Dual Rear Speakers, 4-Speed Automatic Trans, Custom Wheel Covers, Air Conditioning and 5.0 Liter EFI V8 Eng).

REGIONALIZED OPTIONS

ADDITIONAL OPTIONS MAY BE ORDERED FROM THIS LISTING ONLY

ENGINE (Must Order)		Range Sound System and Power Antenna (Incl w/Group BRA2)
N.C. L03 5.0 Liter EFI V8		
EMISSION (Must Order One)	V.P.S. UU6	Electronically Tuned AM/FM Stereo Radio w/Seek-Scan, Stereo Cassette Tape, Graphic Equalizer and Digital Clock w/Extended Range Sound System and Power Antenna
N.C. NA5 Standard Emissions		
100.00 YF5 California Emissions		
TIRES (Must Order One)		Radio Delete (Reqs Group BRAB)
N.C. QCE P205/75 R15 B/W (Radial) (Base) (Reqs Group BRAB)	V.P.S. UL5	
76.00 QCG P205/75 R15 W/S (Radial)		
188.00 QHJ P225/70 R15 W/S (Reqs F41 Suspension)		
WHEELS (May Choose One)		INTERIOR TRIM
N.C. --- Custom Wheel Covers (Base)		N.C. C**5 Cloth 45/55
150.00 N91 Wire Wheel Covers w/Locks (Incl w/Group BRA2)	550.00 A**5 Leather 45/55	
CLIMATE CONTROL		ADDITIONAL OPTIONS
160.00 C49 Defogger, Rear Window: Electric	21.00 G92 Axle, 3.08 Performance	
20.00 K05 Heater, Engine Block	100.00 G80 Axle: Rear, Limited Slip Differential (N/A F41 Suspension)	
RADIO EQUIPMENT	40.00 V08 Cooling, Heavy-Duty	
V.P.S. --- Electronically Tuned AM/FM Stereo Radio w/Seek-Scan and Digital Clock w/Dual Rear Speakers (Base)	N.C. VK3 License Plate Bracket, Front	
V.P.S. UM6 Electronically Tuned AM/FM Stereo Radio w/Seek-Scan, Stereo Cassette Tape and Digital Clock w/Extended	141.00 D84 Paint, Custom Two-Tone	
	215.00 AU3 Power Door Lock System (Incl w/Group BRA2)	
	61.00 D85 Striping, Pin: Body (N/A D84 Paint)	
	26.00 F40 Suspension, Heavy-Duty Front and Rear (N/A F41 Susp)	
	49.00 F41 Suspension, Sport (Reqs QHJ Tires and G92 Axle)	
	30.00 AP9 Trunk Cargo Net	

CAPRICE CLASSIC SEDAN

COLOR AND TRIM SELECTION

PLEASE NOTE: The Exterior Paint and Interior Trim Combinations Shown Below are the Only Combinations that are Available

Interior Trim Color		Dk Blue	Lt Brown	Gray	Maroon
MODEL	SEAT TYPE				
18N69	Cloth Bench	CDD1	CEE1	CQQ1	CFF1
	Cloth 50/50	CDD3	CEE3	CQQ3	CFF3

CUSTOM TWO-TONE PAINT

(D84 Must be Specified in "Plus" (+) Option Section of Order Worksheet)

Exterior Paint Color	Color Code 1	Color Code 2	Vinyl Roof #	Dk Blue	Lt Brown	Gray	Maroon
Black & Med Gray (Met)	41	15	19T			•	
Blue, Dk (Met) & Lt Blue (Met)	29	26	29T	•			
Brown, Lt (Met) & Dk Brown (Met)	57	59	57T		•		
Gray, Medium (Met) & Dk Maroon (Met)	15	79	84T				•
Maroon, Dk (Met) & Dk Red (Met)	79	89	79T				•

#If Vinyl Roof Is Desired, Vinyl Roof Option Must Be Specified In "Plus" (+) Option Section of Order Worksheet.

SOLID PAINT APPLICATION

Exterior Paint Color	Color Code 1	Color Code 2	Dk Blue	Lt Brown	Gray	Maroon
Beige	52	52		•		
Black	41	41			•	•
Blue, Dk (Met)	29	29	•		•	
Blue, Lt (Met)	26	26	•			
Brown, Dk (Met)	59	59		•		
Brown, Lt (Met)	57	57		•		
Gray, Medium (Met)	15	15			•	•
Maroon, Dk (Met)	79	79			•	•
Red, Dk (Met)	89	89			•	•
White	40	40	•	•	•	•

@VINYL ROOF SELECTOR

Beige	52	52		57T		
Black	41	41			19T	19T
Blue, Dk (Met)	29	29	29T		29T	
Blue, Lt (Met)	26	26	29T			
Brown, Dk (Met)	59	59		57T		
Brown, Lt (Met)	57	57		57T		
Gray, Medium (Met)	15	15			84T	84T
Maroon, Dk (Met)	79	79			79T	79T
Red, Dk (Met)	89	89			79T	79T
White	40	40	11T/29T	11T/57T	11T/84T	11T/79T

@Vinyl Roof Option Must Be Specified In "Plus" (+) Option Section of Order Worksheet.

BLACK 19T DARK BLUE (MET) 29T LIGHT BROWN (MET) .. 57T
 MEDIUM GRAY (MET) 84T DARK MAROON (MET) 79T WHITE 11T

POWER TEAMS

ENGINE OPTION CONDITION	AXLE RATIO	
	2.73	3.08
WITH NA5 STANDARD EMISSIONS		
L03 MX0	Std	G92
WITH YF5 CALIFORNIA EMISSIONS		
L03 MX0	Std	G92

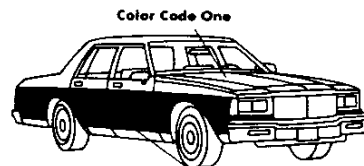

D84 CUSTOM TWO-TONE

CAPRICE CLASSIC SEDAN

15,630.00 **Model 1BN69**

PREFERRED VEHICLE

MUST ORDER ONE GROUP — NO DELETIONS ALLOWED

	BNA1	BNA2
713.00 Preferred Equipment Group 1		
Extended Range Speakers	x	x
Floor Covering: Carpeted Mats, Color-Keyed Front and Rear	x	x
Lighting, Auxiliary	x	x
Mirrors: Sport, Twin Remote	x	x
Moldings, Body Side	x	x
Power Trunk Opener	x	x
Speed Control: Electronic, with Resume Speed	x	x
Steering Wheel, Comfortilt	x	x
Tires, P205/75R15 W/S	x	x
Windshield Wiper System, Intermittent	x	x
2,087.00 Preferred Equipment Group 2		
Electronically Tuned AM/FM Stereo Radio w/Seek-Scan, Stereo Cassette Tape and Digital Clock w/Extended Range Sound System and Power Antenna		x
Mirror: RH Visor, Illuminated		x
Luggage Compartment Trim, Deluxe		x
Power Door Lock System		x
Power Seats: 6-Way Passenger/Driver (w/o Bench Seat)		x
Power Windows		x

Base Vehicles may be ordered by specifying Preferred Equipment Group Code BNAB (Incls Full Wheel Covers, 5.0 Liter EFI V8 Eng, 4-Speed Automatic Trans, Air Conditioning and AM/FM Stereo Radio w/Seek-Scan and Digital Clock w/Dual Rear Speakers).

REGIONALIZED OPTIONS

ADDITIONAL OPTIONS MAY BE ORDERED FROM THIS LISTING ONLY

ENGINE (Must Order)	V.P.S. UU6	Electronically Tuned AM/FM Stereo Radio w/Seek-Scan, Stereo Cassette Tape, Graphic Equalizer and Digital Clock w/Extended Range Sound System and Power Antenna
N.C. L03 5.0 Liter EFI V8		
EMISSION (Must Order One)	V.P.S. UL5	Radio Delete (Reqs Group BNAB)
N.C. NA5 Standard Emissions		
100.00 YF5 California Emissions		
TIRES (Must Order One)	INTERIOR TRIM	
N.C. QCE P205/75 R15 B/W (Radial) (Base) (Reqs Group BNAB)	N.C. C**1 Cloth Bench	
76.00 QCG P205/75 R15 W/S (Radial)	275.00 C**3 Cloth 50/50	
188.00 QHJ P225/70 R15 W/S (Radial) (Reqs F41 Suspension)	ADDITIONAL OPTIONS	
WHEELS (May Choose One)	21.00 G92 Axle, 3.08 Performance	
N.C. --- Full Wheel Covers (Base)	100.00 G80 Axle: Rear, Limited Slip Differential (N/A F41 Suspension)	
65.00 PB2 Custom Wheel Covers	40.00 V08 Cooling, Heavy-Duty	
215.00 N91 Wire Wheel Covers w/Locks	N.C. VK3 License Plate Bracket, Front	
CLIMATE CONTROL	141.00 D84 Paint, Custom Two-Tone	
160.00 C49 Defogger, Rear Window: Electric	215.00 AU3 Power Door Lock System (Incl w/Group BNA2)	
20.00 K05 Heater, Engine Block	61.00 D85 Striping, Pin: Body (N/A D84 Paint)	
RADIO EQUIPMENT	26.00 F40 Suspension, Heavy-Duty Front and Rear (N/A F41 Susp)	
V.P.S. --- Electronically Tuned AM/FM Stereo Radio w/Seek-Scan and Digital Clock w/Dual Rear Speakers (Base)	49.00 F41 Suspension, Sport (Reqs QHJ Tires and G92 Axle)	
V.P.S. UM6 Electronically Tuned AM/FM Stereo Radio w/Seek-Scan, Stereo Cassette Tape and Digital Clock w/Extended Range Sound System and Power Antenna (Incl w/Group BNA2)	30.00 AP9 Trunk Cargo Net	

REVISED: 9-15-89

1990 ORDER GUIDE

CAPRICE
Page 7

Prices Shown Are Manufacturer's Suggested Retail Prices (MSRP) At The Time Of Publication. These Prices Are To Be Used Only As An Aid To Inventory Management Since MSRP Figures Change Periodically. The Vehicle Price Schedule Is The Official Pricing Documentation Of Chevrolet Motor Division And Should Be Used In Discussing Vehicle Prices With Potential Buyers. The Model Prices Shown In The Order Guide Include The Destination Freight Charges.

CAPRICE CLASSIC WAGON

COLOR AND TRIM SELECTION

PLEASE NOTE: The Exterior Paint and Interior Trim Combinations Shown Below are the Only Combinations that are Available

Interior Trim Color		Dk Blue	Lt Brown	Gray	Maroon
MODEL	SEAT TYPE				
1BN35	*Cloth Bench	CDD1	CEE1	CQQ1	CFF1
	*Cloth 50/50	CDD3	CEE3	CQQ3	CFF3
	*Vinyl Bench	VDD1	VEE1	VQQ1	VFF1
	*Vinyl 50/50	VDD3	VEE3	VQQ3	VFF3

*Third Seat Trim is Vinyl

CUSTOM TWO-TONE PAINT

(D84 Must be Specified in "Plus" (+) Option Section of Order Worksheet)

Exterior Paint Color	Color Code 1	Color Code 2	Dk Blue	Lt Brown	Gray	Maroon
Black & Med Gray (Met)	41	15			●	
Blue, Dk (Met) & Lt Blue (Met)	29	26	●			
Brown, Lt (Met) & Dk Brown (Met)	57	59		●		
Gray, Medium (Met) & Dk Maroon (Met)	15	79				●
Maroon, Dk (Met) & Dk Red (Met)	79	89				●

SOLID PAINT APPLICATION

Exterior Paint Color	Color Code 1	Color Code 2	Dk Blue	Lt Brown	Gray	Maroon
Beige	52	52		●		
Black	41	41			●	●
Blue, Dk (Met)	29	29	●		●	
Blue, Lt (Met)	26	26	●			
Brown, Dk (Met)	59	59		●		
Brown, Lt (Met)	57	57		●		
Gray, Medium (Met)	15	15			●	●
Maroon, Dk (Met)	79	79			●	●
Red, Dk (Met)	89	89			●	●
White	40	40	●	●	●	●

POWER TEAMS

ENGINE OPTION CONDITION	AXLE RATIO	
		2.93
WITH NA5 STANDARD EMISSIONS		
LV2 MX0	Std	*G92
WITH YF5 CALIFORNIA EMISSIONS		
LV2 MX0	Std	*G92

*Reqs V08 Cooling.

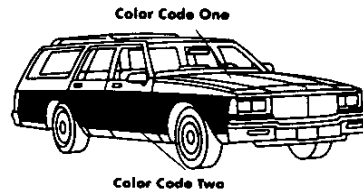

D84 CUSTOM TWO-TONE

CAPRICE CLASSIC WAGON

16,230.00 **Model 1BN35**

PREFERRED VEHICLE

MUST ORDER ONE GROUP — NO DELETIONS ALLOWED

	BWA1	BWA2	BWA3
211.00 Preferred Equipment Group 1			
Floor Carpeting: Deluxe Load Floor	x	x	x
Lighting, Auxiliary	x	x	x
Mirrors: Sport, Twin Remote	x	x	x
Moldings, Body Side	x	x	x
1,556.00 Preferred Equipment Group 2			
Electronically Tuned AM/FM Stereo Radio w/Seek-Scan, Stereo Cassette Tape and Digital Clock w/Dual Rear Speakers and Power Antenna		x	N/I
Floor Covering: Carpeted Mats, Color-Keyed Front and Rear		x	x
Power Door Lock System (Including Tailgate)		x	x
Power Windows		x	x
Roof Carrier		x	x
Speed Control: Electronic, with Resume Speed		x	x
Steering Wheel, Comfortilt		x	x
Windshield Wiper System, Intermittent		x	x
2,475.00 Preferred Equipment Group 3			
Electronically Tuned AM/FM Stereo Radio w/Seek-Scan, Stereo Cassette Tape, Graphic Equalizer and Digital Clock w/Dual Rear Speakers and Power Antenna			x
Gage Package w/Trip Odometer			x
Lamps, Cornering			x
Mirror: Right Hand Visor, Illuminated			x
Rear Compartment Decor, Deluxe			x
Power Seats: 6-Way (Driver/Passenger) (w/o Bench Seat)			x
Twilight Sentinel			x

Base Vehicles may be ordered by specifying Preferred Equipment Group Code BWAB (Incls AM/FM Stereo Radio w/Seek-Scan and Digital Clock w/Dual Rear Speakers, 5.0 Liter V8 Eng, 4-Speed Automatic Trans, Full Wheel Covers, Air Conditioning and P225/75 R15 W/S Tires).

REGIONALIZED OPTIONS

ADDITIONAL OPTIONS MAY BE ORDERED FROM THIS LISTING ONLY

ENGINE (Must Order)		INTERIOR TRIM	
N.C.	LV2 5.0 Liter 4BBL V8	N.C.	C**1 Cloth Bench
EMISSION (Must Order One)		275.00	C**3 Cloth 50/50
N.C.	NA5 Standard Emissions	(-172.00)	V**1 Vinyl Bench
100.00	YF5 California Emissions	103.00	V**3 Vinyl 50/50
TIRES		ADDITIONAL OPTIONS	
N.C.	--- P225/75 R15 W/S (Base)	65.00	C51 Air Deflector (Reqs Groups BWA2 or BWA3)
WHEELS (May Choose One)		21.00	G92 Axle, 3.23 Performance (Reqs V08 Cooling)
N.C.	--- Full Wheel Covers (Base)	100.00	G80 Axle: Rear, Limited Slip Differential
215.00	N91 Wire Wheel Covers w/Locks	40.00	V08 Cooling, Heavy-Duty
65.00	PB2 Custom Wheel Covers	307.00	BX3 Estate Equipment (N/A D84 Paint or D85 Pin Striping)
CLIMATE CONTROL		N.C.	VK3 License Plate Bracket, Front
160.00	C49 Defogger, Rear Window: Electric	141.00	D84 Paint, Custom Two-Tone (N/A BX3 Estate)
20.00	K05 Heater, Engine Block	290.00	AU3 Power Door Lock System (Incls Tailgate Lock) (Incl w/Groups BWA2 and BWA3)
RADIO EQUIPMENT		61.00	D85 Striping, Pin: Body (N/A D84 Paint)
V.P.S.---	Electronically Tuned AM/FM Stereo Radio w/Seek-Scan and Digital Clock w/Dual Rear Speakers (Base)	64.00	G66 Suspension: Shock Absorbers, Inflatable Rear
V.P.S.	UM6 Electronically Tuned AM/FM Stereo Radio w/Seek-Scan, Stereo Cassette Tape and Digital Clock w/Dual Rear Speakers and Power Antenna (Incl w/Group BWA2)		
V.P.S.	UU6 Electronically Tuned AM/FM Stereo Radio w/Seek-Scan, Stereo Cassette Tape, Graphic Equalizer and Digital Clock w/Dual Rear Speakers and Power Antenna (Incl w/Group BWA3)		
V.P.S.	UL5 Radio Delete (Reqs Group BWAB)		

REVISED: 9-15-89

1990 ORDER GUIDE

CAPRICE

Page 9

Prices Shown Are Manufacturer's Suggested Retail Prices (MSRP) At The Time Of Publication. These Prices Are To Be Used Only As An Aid To Inventory Management Since MSRP Figures Change Periodically. The Vehicle Price Schedule Is The Official Pricing Documentation Of Chevrolet Motor Division And Should Be Used In Discussing Vehicle Prices With Potential Buyers. The Model Prices Shown In The Order Guide Include The Destination Freight Charges.

CAPRICE SEDAN

COLOR AND TRIM SELECTION

PLEASE NOTE: The Exterior Paint and Interior Trim Combinations Shown Below are the Only Combinations that are Available

Interior Trim Color		Dk Blue	Lt Brown	Gray	Maroon
MODEL	SEAT TYPE				
1BL69	Cloth Bench	CDD1	CEE1	CQQ1	CFF1
	Cloth 50/50	CDD3	CEE3	CQQ3	CFF3
	Vinyl Bench	VDD1	VEE1	VQQ1	VFF1
	Vinyl 50/50	VDD3	VEE3	VQQ3	VFF3

SOLID PAINT APPLICATION

Exterior Paint Color	Color Code 1	Color Code 2	Dk Blue	Lt Brown	Gray	Maroon
Beige	52	52		●		
Black	41	41			●	●
Blue, Dk (Met)	29	29	●		●	
Blue, Lt (Met)	26	26	●			
Brown, Dk (Met)	59	59		●		
Brown, Lt (Met)	57	57		●		
Gray, Medium (Met)	15	15			●	●
Maroon, Dk (Met)	79	79			●	●
Red, Dk (Met)	89	89			●	●
White	40	40	●	●	●	●

POWER TEAMS

ENGINE OPTION CONDITION	AXLE RATIO	
	2.73	3.08
WITH NA5 STANDARD EMISSIONS		
L03 MX0	Std	G92
WITH YF5 CALIFORNIA EMISSIONS		
L03 MX0	Std	G92

15,030.00 **Model 1BL69**

PREFERRED VEHICLE

MUST ORDER ONE GROUP — NO DELETIONS ALLOWED

	BLA1	BLA2
170.00 Preferred Equipment Group 1		
Extended Range Speakers	x	x
Floor Covering: Carpeted Mats, Color-Keyed Front and Rear	x	x
Moldings, Body Side	x	x
Moldings, Wheel Opening	x	x
820.00 Preferred Equipment Group 2		
Lighting, Auxiliary		x
Power Door Lock System		x
Speed Control: Electronic, with Resume Speed		x
Steering Wheel, Comfortilt		x
Windshield Wiper System, Intermittent		x

Base Vehicles may be ordered by specifying Preferred Equipment Group Code BLAB (Incls 5.0 Liter EFI V8 Eng, 4-Speed Automatic Trans, Full Wheel Covers, Air Conditioning and AM/FM Stereo Radio w/Seek-Scan and Digital Clock w/Dual Rear Speakers).

REGIONALIZED OPTIONS

ADDITIONAL OPTIONS MAY BE ORDERED FROM THIS LISTING ONLY

ENGINE (Must Order)	V.P.S. UU6	Electronically Tuned AM/FM Stereo Radio w/Seek-Scan, Stereo Cassette Tape, Graphic Equalizer and Digital Clock w/Extended Range Sound System
N.C. L03 5.0 Liter EFI V8		
EMISSION (Must Order One)	V.P.S. UL5	Radio Delete (Reqs Group BLAB)
N.C. NA5 Standard Emissions		INTERIOR TRIM
100.00 YF5 California Emissions		N.C. C**1 Cloth Bench
TIRES (Must Order One)		275.00 C**3 Cloth 50/50
N.C. QCE P205/75 R15 B/W (Radial) (Base)		28.00 V**1 Vinyl Bench
76.00 QCG P205/75 R15 W/S (Radial)		305.00 V**3 Vinyl 50/50
WHEELS (May Choose One)		ADDITIONAL OPTIONS
N.C. --- Full Wheel Covers (Base)		21.00 G92 Axle, 3.08 Performance
65.00 PB2 Custom Wheel Covers		100.00 G80 Axle: Rear, Limited Slip Differential
CLIMATE CONTROL		40.00 V08 Cooling, Heavy Duty
160.00 C49 Defogger, Rear Window: Electric		N.C. VK3 License Plate Bracket, Front
20.00 K05 Heater, Engine Block		215.00 AU3 Power Door Lock System (Incl w/Group BLA2)
RADIO EQUIPMENT		26.00 F40 Suspension: Heavy-Duty, Front and Rear
V.P.S. --- Electronically Tuned AM/FM Stereo Radio w/Seek-Scan and Digital Clock w/Dual Rear Speakers (Base)		30.00 AP9 Trunk Cargo Net
V.P.S. UM6 Electronically Tuned AM/FM Stereo Radio w/Seek-Scan, Stereo Cassette Tape and Digital Clock w/Extended Range Sound System		

SOLID PAINT APPLICATION

STRIPE COLOR ONLY WHEN D85 STRIPE IS ORDERED (N/A 1BL69)

MOLDING COLOR ONLY WHEN BODY SIDE MOLDING IS ORDERED (With BX3 Estate Equipment, Molding Color is Woodgrain.)

Exterior Paint Color	Stripe Molding	Interior Trim Color			
		Dk Blue	Lt Brown	Gray	Maroon
Beige 52	Stripe Molding		● Med Brown Lt Brown Met		
Black 41	Stripe Molding			● Lt Gray Black	● Red Black
Blue, Dark (Met) 29	Stripe Molding	● Med Blue Dk Blue		● Lt Gray Dk Blue	
Blue, Light (Met) 26	Stripe Molding	● Med Blue Dk Blue			
Brown, Dark (Met) 59	Stripe Molding		● Saddle Lt Brown Met		
Brown, Light (Met) 57	Stripe Molding		● Med Brown Lt Brown Met		
Gray, Medium (Met) 15	Stripe Molding			● Lt Gray Med Gray Met	● Dk Maroon Med Gray Met
Maroon, Dark (Met) 79	Stripe Molding			● Lt Gray Dk Maroon Met	● Red Dk Maroon Met
Red, Dark (Met) 89	Stripe Molding			● Lt Gray Dk Maroon Met	● Dk Maroon Dk Maroon Met
White 40	Stripe Molding	● Med Blue White	● Saddle White	● Med Gray White	● Dk Maroon White

D84 CUSTOM TWO-TONE PAINT (NO SUBSTITUTES ALLOWED) (N/A 1BL69)

STRIPE COLOR-INCLUDED

MOLDING COLOR-ONLY WHEN BODY SIDE MOLDING IS ORDERED

VINYL ROOF-ONLY WHEN APPROPRIATE ORDERING CODE IS INDICATED

Exterior Paint Color	Color Code 1	Color Code 2	Vinyl Roof	Stripe (included)	Molding
Black & Med Gray (Met)	41	15	19T	Red/Med Gray (Met)	Med Gray (Met)
Blue, Dark (Met) & Lt Blue (Met)	29	26	29T	Brt Blue/Dk Blue	Dk Blue
Brown, Light (Met) & Dk Brown (Met)	57	59	57T	Orange/Lt Brown (Met)	Lt Brown (Met)
Gray, Medium (Met) & Dk Maroon (Met)	15	79	84T	Red/Med Gray (Met)	Dk Maroon (Met)
Maroon, Dark (Met) & Dk Red (Met)	79	89	79T	Red/Dk Red (Met)	Dk Maroon (Met)

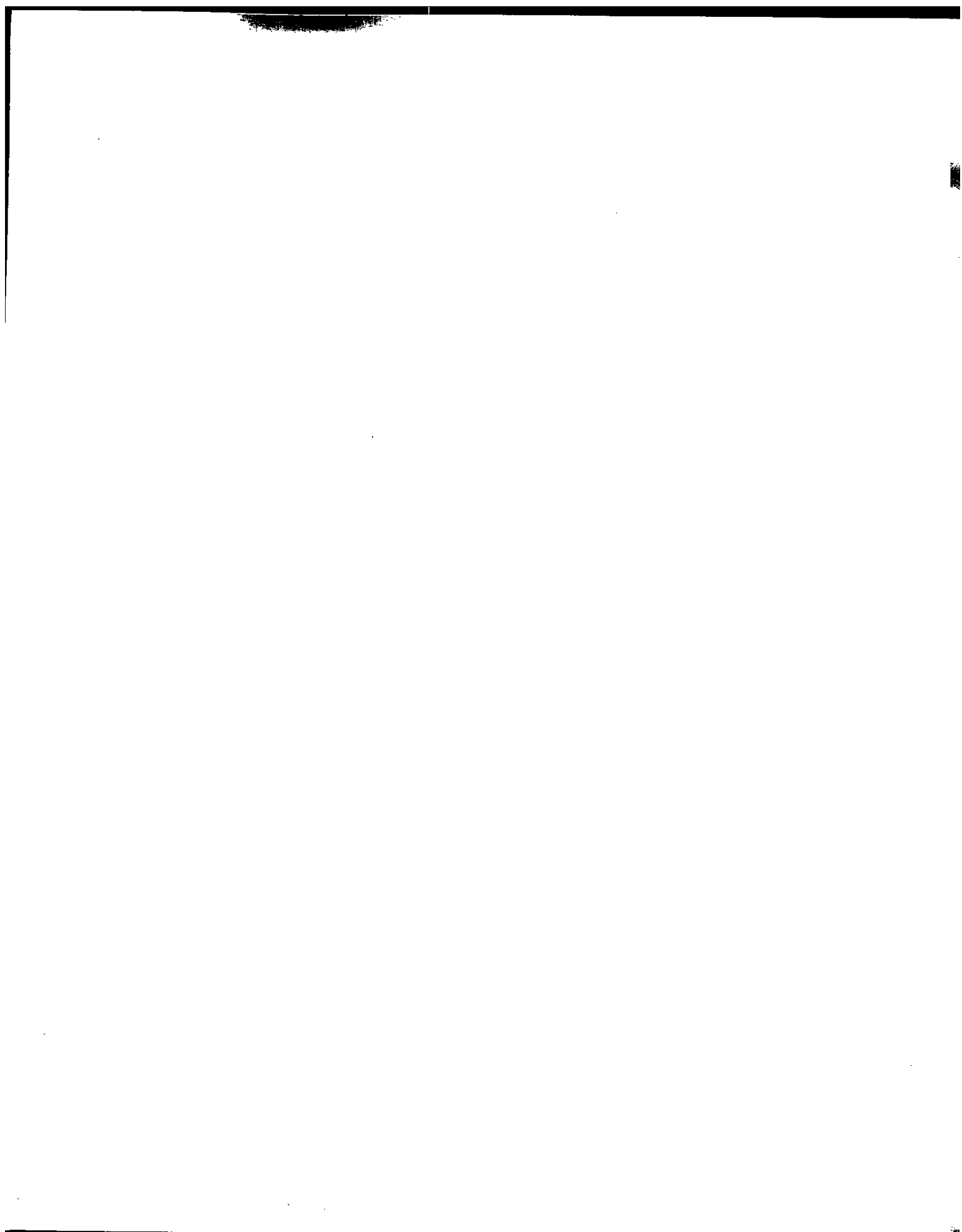

METRIC (U.S. Customary)

Design & development (company)	Chevrolet-Pontiac-GM of Canada
Where built (country)	U.S.A.
Authorized U.S. Sales marketing representative	Chevrolet Motor Division

o **Vehicle Models**

Model Description & Drive (FWD/RWD/AWD/4WD)	Introduction Date	Make, Vehicle Models, Series, Body Type (Mfg's Model Code)	No. of Designated Seating Positions (Front/Rear)	Max. Trunk/Cargo Load-Kilograms (Pounds)
CAPRICE				
4-Door Notchback Sedan (RWD)		1BL69	6 (3/3)	90.7 (200)
CAPRICE CLASSIC				
4-Door Notchback Sedan (RWD)		1BN69	6 (3/3)	90.7 (200)
4-Door Station Wagon (RWD)		1BN35	8 (3/3/2)	136.1 (300)
CAPRICE BROUGHAM				
4-Door Notchback Sedan (RWD)		1BU69	6 (3/3)	90.7 (200)

* FWD - Front Wheel Drive RWD - Rear Wheel Drive AWD - All Wheel Drive 4WD - Four Wheel Drive

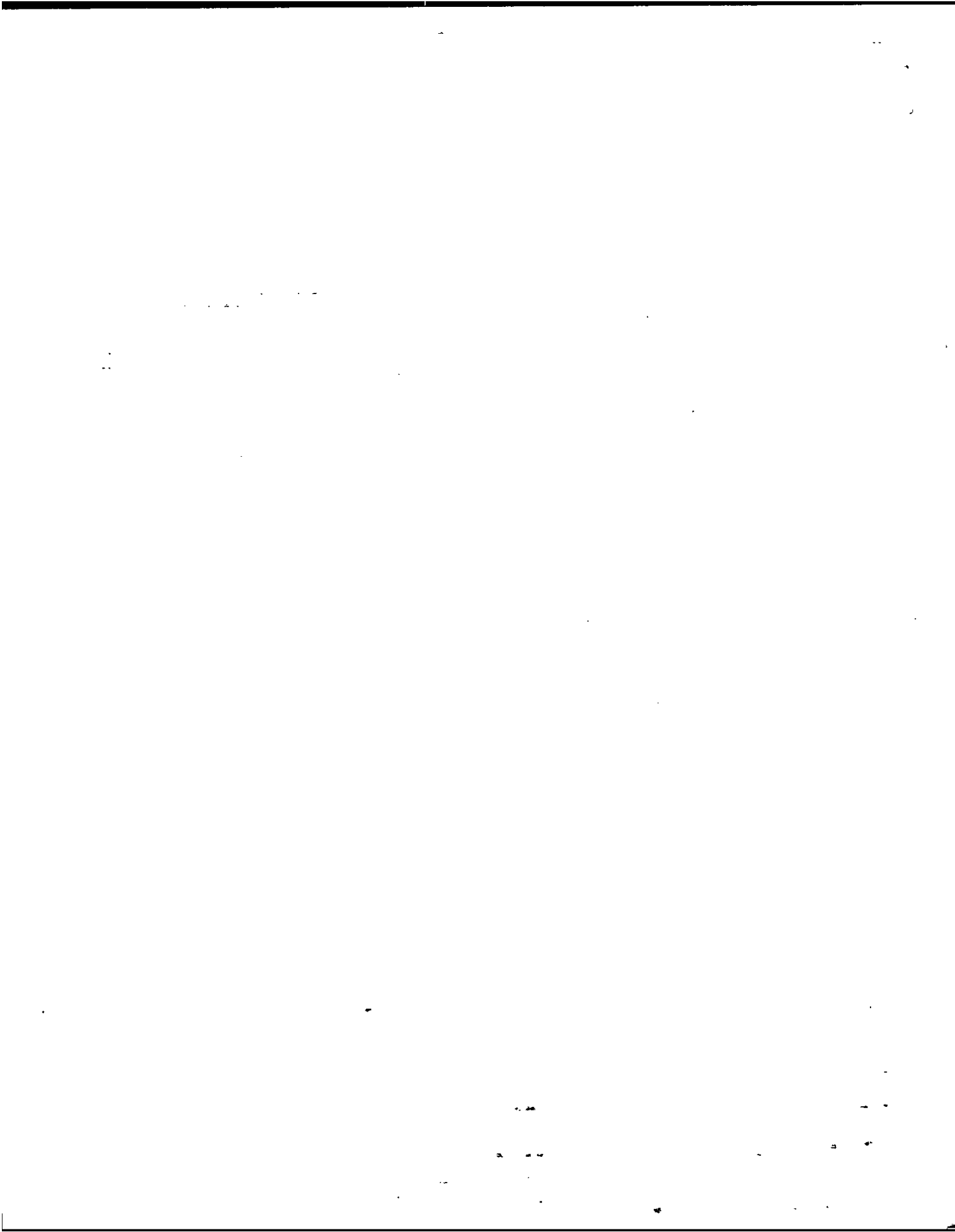

MVMA Specifications

Vehicle Line - CAPRICE
 Model Year 1990 Issued 6-89 Revised(*) 9-89

METRIC (U.S. Customary) Power Teams

SAE J1349 Net bhp (brake hrspwr) and Net Torque corrected to 77 deg. F / 25 deg. C and 29.81 in. Hg/100 kPA atmos. press.

		A	B	C	D	
E N G I N E	Engine Code	L03	L03	L05	LB4	
	Displacement Liters (cu. in.)	5.0 (305)	5.0 (305)	5.7 (350)	4.3 (262)	
	Induction system (FI, Carb, etc.)	Throttle Body Injection	Throttle Body Injection	Throttle Body Injection	Throttle Body Injection	
	Compression ratio	9.3:1	9.3:1	9.8:1	9.3:1	
	SAE Net at RPM	Power kW (bhp)	127 (170) @ 4400	127 (170) @ 4400	145 (195) @ 4400	104 (140) @ 4000
		Torque Newton meters (lb.ft.)	346 (255) @ 2400	346 (255) @ 2400	393 (290) @ 2400	305 (225) @ 2000
Exhaust Single, dual		Single	Single	Single	Single	
T R A N S	Transmission/ Transaxle	MW9 Auto Transmission 4-Speed	MW9 Auto Transmission 4-Speed	MD8 Auto Transmission 4-Speed	MD8 Auto Transmission 4-Speed	
	Axle Ratio (std. first)	2.73	3.08	3.42	2.56	

Series Availability

Power Teams (A - B - C - D)

Model	Code	Standard	Optional
CAPRICE			
4-Dr. Notchback Sedan	1BL69	A	B
CAPRICE CLASSIC			
4-Dr. Notchback Sedan	1BN69	A	B
4-Dr. Station Wagon	1BN35	F	G
CAPRICE BROUGHAM			
4-Dr. Notchback Sedan	1BU69	A	B
CAPRICE (FLEET VEHICLES ONLY)			
4-Dr. Notchback Sedan	1BA69	D	E
CAPRICE (POLICE VEHICLES)			
4-Dr. Notchback Sedan	1BA69	B	C, E



1
2

3

4



MVMA Specifications

Vehicle Line CAPRICE
 Model Year 1990 Issued 6-89 Revised(*) 9-89

METRIC (U.S. Customary)

Engine Description
 Engine Code

5.0 LITER V8 (305 CID)
 THROTTLE BODY INJECTION RPO L03

ENGINE - GENERAL

Type & description (inline, V, angle, flat, location, front, mid, rear, transverse, longitudinal, sohc, dohc, ohv, hemi, wedge, pre-chamber, etc.)	90 deg. V, Front, Longitudinal	
Manufacturer	C-P-C Group - G.M. Corporation	
No. of cylinders	8	
Bore	94.89mm (3.74 in.)	
Stroke	88.39mm (3.48 in.)	
Bore spacing (C/L to C/L)	111.8mm (4.40 in.)	
Cyl block matl & mass kg(lbs.) ^(machined)	Cast Iron, 68.674 (151.4)	
Cylinder block deck height	229.4mm (9.025 in.)	
Cylinder block length	512.8mm (20.19 in.)	
Deck clearance (minimum) (above or below block)	.635mm (.025 in.), Below	
Cyl. head material & mass kg (lbs.)	Cast Iron, 19.800 (43.7)	
Cylinder head volume (cu. cm.)	55.9 (3.41)	
Cylinder liner material	Not Applicable	
Head gasket thickness (compressed)	.724mm (.0285 in.)	
Minimum combustion chamber total volume (cm. cu.)	55.2 (+/- 2.2)	
Cyl. no. system (front to rear)	L. Bank	1-3-5-7
	R. Bank	2-4-6-8
Firing order	1-8-4-3-6-5-7-2	
Intake manifold matl & mass kg(lbs.) ^(**)	Aluminum, 6.900 (15.2)	
Exh. manifold matl & mass kg (lbs.) ^(**)	Cast Iron, 4.345 (9.6) L.H., 3.800 (8.4) R.H.	
Fuel required unleaded, diesel, etc.	Unleaded	
Fuel antiknock index (R + M) / 2	87	
Engine mounts	Quantity	2
	Matl and type (elastomeric, hydroelastic, hydraulic damper, etc.)	Elastomeric
	Added isolation (sub-frame, crossmember, etc.)	Not Applicable
Total dressed engine mass (wt) dry ^(***)	275.1 kg. (606 lbs.) Auto., 290.8 kg. (641 lbs.) Man.	

Engine - Pistons

Material & mass, g (weight, oz.) - piston only	Aluminum Alloy, .845 (1.4)
--	-------------------------------

Engine Camshaft

Location	Cylinder Block Above Crankshaft	
Material & mass kg (weight, lbs.)	Steel, 4.124 (9.1)	
Drive type	Chain/belt	Chain
	Width/pitch	15.87mm (6.25 in.) / 12.7mm (.500 in.)

*Rear of engine - drive takeoff. View from drive takeoff end to determine left & right side of engine.

**Finished state.

***Dressed engine mass (weight) includes the following:



MVMA Specifications

Vehicle Line CAPRICE POLICE VEHICLE (SEO 9C1)
 Model Year 1990 Issued 6-89 Revised(*) 9-89

METRIC (U.S. Customary)

Engine Description
 Engine Code

5.0 LITER V8 (305 CID)
 THROTTLE BODY INJECTION RPO L03

ENGINE - GENERAL

Type & description (inline, V, angle, flat, location, front, mid, rear, transverse, longitudinal, sohc, dohc, ohv, hami, wedge, pre-chamber, etc.)	90 deg. V, Front, Longitudinal, OHV	
Manufacturer	C-P-C Group - G.M. Corporation	
No. of cylinders	8	
Bore	94.89mm (3.74 in.)	
Stroke	88.39mm (3.48 in.)	
Bore spacing (C/L to C/L)	111.8mm (4.40 in.)	
Cyl blk matl & mass kg(lbs.)(machined)	Cast Iron, 68.674 (151.4)	
Cylinder block deck height	229.4mm (9.025 in.)	
Cylinder block length	512.8mm (20.19 in.)	
Deck clearance (minimum) (above or below block)	.635mm (.025 in.), Below	
Cyl. head material & mass kg (lbs.)	Cast Iron, 19.800 (43.7)	
Cylinder head volume (cu. cm.)	--	
Cylinder liner material	Not Applicable	
Head gasket thickness (compressed)	.724mm (.0285 in.)	
Minimum combustion chamber total volume (cm. cu.)	--	
Cyl. no. system (front to rear)	L. Bank	1-3-5-7
	R. Bank	2-4-6-8
Firing order	1-8-4-3-6-5-7-2	
Intake manifold matl & mass(kg(lbs.))**	Iron, 18.733 (41.3)	
Exh. manifold matl & mass [kg (lbs.)]**	Cast Iron, 3.900 (8.6) L.H., 3.800 (8.4) R.H.	
Fuel required unleaded, diesel, etc.	Unleaded	
Fuel antiknock index (R + M) / 2	87	
Engine mounts	Quantity	2
	Matl and type (elastomeric, hydroelastic, hydraulic damper, etc.)	Elastomeric
	Added isolation (sub-frame, crossmember, etc.)	Not Applicable
Total dressed engine mass (wt) dry***		

Engine - Pistons

Material & mass, g (weight, oz.) - piston only	Aluminum Alloy, .502 (1.107)
--	---------------------------------

Engine Camshaft

Location	Cylinder Block Above Crankshaft	
Material & mass kg (weight, lbs.)	Steel, 4.124 (9.1)	
Drive type	Chain/belt	Chain
	Width/pitch	15.87mm (6.25 in.) / 12.7mm (.500 in.)

*Rear of engine - drive takeoff. View from drive takeoff end to determine left & right side of engine.

**Finished state.

***Dressed engine mass (weight) includes the following:

MVMA Specifications

Vehicle Line CAPRICE POLICE VEHICLE (SEO 9C1)
 Model Year 1990 Issued 8-89 Revised(*) 9-89

METRIC (U.S. Customary)

Engine Description
 Engine Code

5.7 LITER V8 (350 CID)
 THROTTLE BODY INJECTION RPO L05

ENGINE - GENERAL

Type & description (inline, V, angle, flat, location, front, mid, rear, transverse, longitudinal, sohc, dohc, ohv, hemi, wedge, pre-chamber, etc.)		90 deg. V, Front, Longitudinal, OHV
Manufacturer		C-P-C Group - G.M. Corporation
No. of cylinders		8
Bore		101.6mm (4.00 in.)
Stroke		88.4mm (3.48 in.)
Bore spacing (C/L to C/L)		111.8mm (4.40 in.)
Cyl block matl & mass kg(lbs.) (machined)		Cast iron
Cylinder block deck height		229.2mm (9.025 in.)
Cylinder block length		506.2mm (19.93 in.)
Deck clearance (minimum) (above or below block)		.635mm (.025 in.), Below
Cyl. head material & mass kg (lbs.)		Cast iron
Cylinder head volume (cu. cm.)		--
Cylinder liner material		Not Applicable
Head gasket thickness (compressed)		.724mm (.0285 in.)
Minimum combustion chamber total volume (cm. cu.)		--
Cyl. no. system (front to rear)	L. Bank	1-3-5-7
	R. Bank	2-4-6-8
Firing order		1-8-4-3-6-5-7-2
Intake manifold matl & mass [kg(lbs.)]**		Cast Aluminum, 6.900 (15.2)
Exh. manifold matl & mass [kg (lbs.)]**		Cast Iron
Fuel required unleaded, diesel, etc.		Unleaded
Fuel antiknock index (R + M) / 2		87
Engine mounts	Quantity	2
	Matl and type (elastomeric, hydroelastic, hydraulic damper, etc.)	Elastomeric
	Added isolation (sub-frame, crossmember, etc.)	Not Applicable
Total dressed engine mass (wt) dry***		

Engine - Pistons

Material & mass, g (weight, oz.) - piston only	Cast Aluminum, .540 (1.2)
--	---------------------------

Engine Camshaft

Location	In Block Above Crankshaft	
Material & mass kg (weight, lbs.)	Steel, 4.200 (9.3)	
Drive type	Chain/belt	Chain
	Width/pitch	15.87mm (6.25 in.) / 12.70mm (.500 in.)

*Rear of engine - drive takeoff. View from drive takeoff end to determine left & right side of engine.

**Finished state.

***Dressed engine mass (weight) includes the following:



MVMA Specifications

Vehicle Line CAPRICE FLEET VEHICLE
 Model Year 1990 Issued 6-89 Revised(*) 9-89

METRIC (U.S. Customary)

Engine Description
 Engine Code

4.3 LITER V6 (262 CID)
 THROTTLE BODY INJECTION RPO LB4

ENGINE - GENERAL

Type & description (inline, V, angle, flat, location, front, mid, rear, transverse, longitudinal, sohc, dohc, ohv, hemi, wedge, pre-chamber, etc.)		90 deg. V, Front, Longitudinal, OHV
Manufacturer		C-P-C Group - G.M. Corporation
No. of cylinders		6
Bore		101.60mm (4.00 in.)
Stroke		88.39mm (3.48 in.)
Bore spacing (C/L to C/L)		111.80mm (4.4 in.)
Cyl block matl & mass kg(lbs.)(machined)		Cast Iron, 46.5 (102.5) Machined
Cylinder block deck height		Not Available
Cylinder block length		434mm (17.1 in.)
Deck clearance (minimum) (above or below block)		Not Available
Cyl. head material & mass kg (lbs.)		Cast Iron, 16.330 (36.0)
Cylinder head volume (cu. cm.)		Not Available
Cylinder liner material		Not Available
Head gasket thickness (compressed)		.533mm (.021 in.)
Minimum combustion chamber total volume (cm. cu.)		65.38 +/- 2.2 cc.
Cyl. no. system (front to rear)	L. Bank	1-3-5
	R. Bank	2-4-6
Firing order		1-6-5-4-3-2
Intake manifold matl & mass[kg(lbs.)]**		Cast Aluminum, 5.00 (11.0)
Exh. manifold matl & mass [kg (lbs.)]**		Stainless Steel, 3.146 (6.9) RH 2.141 (4.7) LH
Fuel required unleaded, diesel, etc.		Unleaded
Fuel antiknock index (R + M) / 2		87
Engine mounts	Quantity	3
	Matl and type (elastomeric, hydroelastic, hydraulic damper, etc.)	Elastomeric - Conventional 3 Pt. Mount System
	Added isolation (sub-frame, crossmember, etc.)	Not Applicable
Total dressed engine mass (wt) dry***		191 kg. (421 lbs.) (Includes - Full Accessory Drive, Air Cleaner, Clutch/Fan Assembly, A.I.R., Oil Cooler, And All Hoses) W/O Trans Housing

Engine - Pistons

Material & mass, g (weight, oz.) - piston only	.598
--	------

Engine Camshaft

Location		In Block Above Crankshaft
Material & mass kg (weight, lbs.)		Steel
Drive type	Chain/belt	Chain
	Width/pitch	.625mm/.5 in.

*Rear of engine - drive takeoff. View from drive takeoff end to determine left & right side of engine.
 **Finished state.
 ***Dressed engine mass (weight) includes the following:



MVMA Specifications

Vehicle Line CAPRICE
 Model Year 1990 Issued 6-89 Revised^(*) 9-89

METRIC (U.S. Customary)

Engine Description
 Engine Code

5.0 LITER V8 (307 CID)
 4-BBL CARBURETOR RPO LV2

ENGINE - GENERAL

Type & description (inline, V, angle, flat, location, front, mid, rear, transverse, longitudinal, sohc, dohc, ohv, hemi, wedge, pre-chamber, etc.)	90 deg. V, Front, Longitudinal	
Manufacturer	B-O-C Lansing Automotive Division	
No. of cylinders	8	
Bore	96.50 mm (3.800 in.)	
Stroke	85.98 mm (3.385 in.)	
Bore spacing (C/L to C/L)	117.5 mm (4.625 in.)	
Cyl block matl & mass kg(lbs.)(machined)	Cast Iron, 72.600 (160.1)	
Cylinder block deck height	237 mm (9.330 in.)	
Cylinder block length	608.90 mm (23.9725 in.)	
Deck clearance (minimum) (above or below block)	.29 mm (0.0116 in.), Below	
Cyl. head material & mass kg (lbs.)	Cast Iron, 22.00 (48.5)	
Cylinder head volume (cu. cm.)	63.45 (3.87)	
Cylinder liner material	Not Applicable	
Head gasket thickness (compressed)	1.07 mm (.042 +/- .002 in.)	
Minimum combustion chamber total volume (cm. cu.)	86.05 (5.25)	
Cyl. no. system (front to rear)	L. Bank	1-3-5-7
	R. Bank	2-4-6-8
Firing order	1-8-4-3-6-5-7-2	
Intake manifold matl & mass(kg(lbs.)) ^{**}	Cast Iron, 8.650 (19.1)	
Exh. manifold matl & mass (kg (lbs.)) ^{**}	L.H. 2.120 (4.7), R.H. 3.150 (6.9)	
Fuel required unleaded, diesel, etc.	Unleaded	
Fuel antiknock index (R + M) / 2	87	
Engine mounts	Quantity	2
	Matl and type (elastomeric, hydroelastic, hydraulic damper, etc.)	Elastomeric
	Added isolation (sub-frame, crossmember, etc.)	Not Applicable
Total dressed engine mass (wt) dry ^{***}	285.4 kg. (629.2 lbs.)	

Engine - Pistons

Material & mass, g (weight, oz.) - piston only	Aluminum Alloy, 564.2 (19.9)
--	---------------------------------

Engine Camshaft

Location	Center	
Material & mass kg (weight, lbs.)	Steel, 5.000 (11.0)	
Drive type	Chain/belt	Chain
	Width/pitch	18.29 - 19/05 mm (.720 - .750 in.)/12.7 mm (.500 in.)

*Rear of engine - drive takeoff. View from drive takeoff end to determine left & right side of engine.

**Finished state.

***Dressed engine mass (weight) includes the following:



MVMA Specifications

Vehicle Line CAPRICE / CAPRICE POLICE VEHICLE (SEO 9C1)
 Model Year 1990 Issued 6-89 Revised(*) _____

METRIC (U.S. Customary)

Engine Description	5.0 LITER V8 (305 CID) THROTTLE BODY INJECTION RPO L03
Engine Code	

Engine - Valve System

Hydraulic lifters (std., opt., NA)	Standard	
Valves	Number intake/exhaust	8/8
	Head O.D. intake/exhaust	46.74 (1.84) / 38.10 (1.50)

Engine - Connecting Rods

Material & mass [kg., (weight, lbs.)]*	Steel, .388 (.855)
Length (axes centerline to centerline)	

Engine - Crankshaft

Material & mass [kg., (weight, lbs.)]*	Nodular Cast Iron, 23.360 (51.50)	
End thrust taken by bearing (no.)	5	
Length & number of main bearings	5	
Seal material, one, two piece design, etc.)	Front	Fluroelastomer, One Piece, Lip Seal
	Rear	Fluroelastomer, One Piece, Lip Seal

Engine - Lubrication System

Normal oil pressure (kPa(psi) @ eng rpm)	41 (6) @ 1000/124 (18) @ 2000/165 (24) @ 4000 (Hot)
Type oil intake (floating, stationary)	Stationary
Oil filter sys. (full flow, part, other)	Full Flow
Capacity of c/case, less filter-refill-L (qt.)	3.8 (4.0)

Engine - Diesel Information

(NOT APPLICABLE)

Diesel engine manufacturer		
Glow plug, current drain at 0 deg. F		
Injector Nozzle	Type	
	Opening pressure (kPa(psi))	
Pre-chamber design		
Fuel injection pump	Manufacturer	
	Type	
Fuel inj. pump drive (belt, chain, gear)		
Supplementary vacuum source (type)		
Fuel heater (yes/no)		
Water separator, description (std., opt.)		
Turbo manufacturer		
Oil cooler-type (oil to engine coolant; oil to ambient air)		
Oil filter		

Engine - Intake System

(NOT APPLICABLE)

Turbo charger - manufacturer	
Super charger - manufacturer	
Intercooler	

* Finished State

MVMA Specifications

Vehicle Line CAPRICE POLICE VEHICLE (SEO 8C1)
 Model Year 1990 Issued 6-89 Revised(*)

METRIC (U.S. Customary)

Engine Description	5.7 LITER V8 (350 CID)
Engine Code	THROTTLE BODY INJECTION RPO L05

Engine - Valve System

Hydraulic lifters (std., opt., NA)	Standard	
Valves	Number intake/exhaust	8/8
	Head O.D. Intake/exhaust	49.28mm (1.94 in.) / 38.10mm (1.50 in.)

Engine - Connecting Rods

Material & mass (kg., (weight, lbs.))*	Steel, .388 (0.855)
Length (axis centerline to centerline)	144.78mm (5.7 in.)

Engine - Crankshaft

Material & mass (kg., (weight, lbs.))*	Nodular Cast Iron, 22.900 (50.49)	
End thrust taken by bearing (no.)	5	
Length & number of main bearings	5	
Seal (material, one, two piece design, etc.)	Front	Fluoroelastomer, One Piece, Lip Seal
	Rear	Fluoroelastomer, One Piece, Lip Seal

Engine - Lubrication System

Normal oil pressure (kPa (psi) @ eng rpm)	Min. (Hot): 41 (6) @ 1000 / 124 (18) @ 2000 / 165 (24) @ 4000
Type oil intake (floating, stationary)	Stationary
Oil filter sys. (full flow, part, other)	Full Flow
Capacity of c/case, less filter-refill-L (qt)	3.8 (4.0)

Engine - Diesel Information (NOT APPLICABLE)

Diesel engine manufacturer		
Glow plug, current drain at 0 deg. F		
Injector Nozzle	Type	
	Opening pressure (kPa (psi))	
Pre-chamber design		
Fuel injection pump	Manufacturer	
	Type	
Fuel inj. pump drive (belt, chain, gear)		
Supplementary vacuum source (type)		
Fuel heater (yes/no)		
Water separator, description (std., opt.)		
Turbo manufacturer		
Oil cooler-type (oil to engine coolant; oil to ambient air)		
Oil filter		

Engine - Intake System (NOT APPLICABLE)

Turbo charger - manufacturer	
Super charger - manufacturer	
Intercooler	

* Finished State



MVMA Specifications

Vehicle Line CAPRICE FLEET VEHICLE
 Model Year 1990 Issued 6-89 Revised(*)

METRIC (U.S. Customary)

Engine Description	4.3 LITER V6 (282 CID)
Engine Code	THROTTLE BODY INJECTION RPO LB4

Engine - Valve System

Hydraulic lifters (std., opt., NA)	Standard	
Valves	Number intake/exhaust	8/8
	Head O.D. intake/exhaust	49.28mm (1.94 in.) / 38.10mm (1.50 in.)

Engine - Connecting Rods

Material & mass [kg., (weight, lbs.)]*	1141 Steel/Forging .633 +/- 10 grams - Rod Including Bolts And Nuts But Not Bearing Shells
Length(axes centerline to centerline)mm	144.81 - 144.75

Engine - Crankshaft

Material & mass [kg., (weight, lbs.)]*	Nodular Cast Iron	
End thrust taken by bearing (no.)	4	
Length & number of main bearings	4	
Seal (material, one, two piece design, etc.)	Front	One Piece CMB ZZ005AA
	Rear	Two Piece CMB ZZ005AA Gasket, Non-Asbestos, .71 + .16 Thick

Engine - Lubrication System

Normal oil pressure(kPa(psi) @ eng rpm)	345 - 488 (50 - 65) @ 2000
Type oil intake (floating, stationary)	Stationary
Oil filter sys. (full flow, part, other)	Full Flow
Capacity of c/case, less filter--refill-L (qt.)	3.8 (4.0)

Engine - Diesel Information

(NOT APPLICABLE)

Diesel engine manufacturer		
Glow plug, current drain at 0 deg. F		
Injector Nozzle	Type	
	Opening pressure(kPa(psi))	
Pre-chamber design		
Fuel injection pump	Manufacturer	
	Type	
Fuel inj. pump drive (belt, chain, gear)		
Supplementary vacuum source (type)		
Fuel heater (yes/no)		
Water separator, description (std., opt.)		
Turbo manufacturer		
Oil cooler--type (oil to engine coolant; oil to ambient air)		
Oil filter		

Engine - Intake System

(NOT APPLICABLE)

Turbo charger - manufacturer	
Super charger - manufacturer	
Intercooler	

* Finished State



MVMA Specifications

Vehicle Line CAPRICE
 Model Year 1990 Issued 6-89 Revised(*) 8-89

METRIC (U.S. Customary)

Engine Description **5.0 LITER V8 (307 CID)**
 Engine Code **4-BBL CARBURETOR RPO LV2**

Engine - Valve System

Hydraulic lifters (std., opt., NA)	Standard	
Valves	Number intake/exhaust	8/8
	Head O.D. intake/exhaust	44.45 mm (1.75 in.)/38.15 mm (1.502 in.)

Engine - Connecting Rods

Material & mass (kg., (weight, lbs.))*	Steel .625 (1.4)
Length (axes centerline to centerline)	152.4 mm (6.000 in.)

Engine - Crankshaft

Material & mass (kg., (weight, lbs.))*	Cast Iron, 22.400 (49.4)	
End thrust taken by bearing (no.)	3	
Length & number of main bearings	#1,2 & 4-24.89 mm(.89 in.) #3 30.35 mm(1.195 in.) #5 41.25 mm (1.624in)/5	
Seal (material, one, two piece design, etc.)	Front	Neoprene Lip, One Piece
	Rear	Rope, Two Piece

Engine - Lubrication System

Normal oil pressure(kPa(psi) @ eng rpm)	207-310 (30-45) @ 1500
Type oil intake (floating, stationary)	Stationary
Oil filter sys. (full flow, part, other)	Full Flow
Capacity of c/case, less filter-refill-L (qt.)	3.75 (4.0)

Engine - Diesel Information (NOT APPLICABLE)

Diesel engine manufacturer		
Glow plug, current drain at 0 deg. F		
Injector Nozzle	Type	
	Opening pressure(kPa(psi))	
Pre-chamber design		
Fuel injection pump	Manufacturer	
	Type	
Fuel inj. pump drive (belt, chain, gear)		
Supplementary vacuum source (type)		
Fuel heater (yes/no)		
Water separator, description (std., opt.)		
Turbo manufacturer		
Oil cooler-type (oil to engine coolant; oil to ambient air)		
Oil filter		

Engine - Intake System (NOT APPLICABLE)

Turbo charger - manufacturer	
Super charger - manufacturer	
Intercooler	

* Finished State



MVMA Specifications

Vehicle Line CAPRICE / CAPRICE POLICE VEHICLE (SEO 9C1)
 Model Year 1990 Issued 6-89 Revised(*)

METRIC (U.S. Customary)

Engine Description
 Engine Code

5.0 LITER V8 (305 CID)
 THROTTLE BODY INJECTION RPO L03

Engine - Cooling System

Coolant recovery system (std, opt, n.a.)		Standard		
Coolant fill location (rad., bottle)		Bottle, Coolant Recovery		
Radiator cap relief valve pressure [kPa (psi)]		103.4 (15.0)		
Circulation thermostat	Type (choke, bypass)	Choke		
	Starts to open @ deg's C(F)	91 (195)		
Water Pump	Type (centrifugal, other)	Centrifugal		
	GPM 1000 pump rpm	14		
	Number of pumps	1		
	Drive (V-belt, other)	Serpentine Belt		
	Bearing type	Sealed Double Row Ball		
	Impeller material	Steel		
Housing material		Cast Iron		
By-pass recirculation [type (inter., ext.)]		Internal		
Cooling system capacity	With heater - L (qt.)	15.04 (15.89)		
	With air conditioner-L(qt.)	14.97 (15.82)		
	Opt. equip.[specify-L(qt.)]	15.69 (16.58)		
Water jackets full length of cy(yes,no)		Yes		
Water all around cylinder (yes, no)		Yes		
Water jackets open at head face (yes,no)		Yes		
Radiator core	Std., A/C, HD	Standard	A/C	HD
	Type (cross-flow, etc.)	Cross-Flow		
	Construction (fin & tube mechanical, braze, etc.)	Fin & Tube		
	Matl., mass [kg(wgt., lbs.)]	Copper-Brass, High Efficiency Radiator		
	Width	668.0 mm	668.0 mm	668.0 mm
	Height	429.7 mm	429.7 mm	429.7 mm
	Thickness	25.0 mm	25.0 mm	40.2 mm
	Fins per inch *	2.5 mm	2.5 mm	2.5 mm
Radiator end tank material				
Fan	Std., elec., opt.	Standard		A/C
	Number of blades & type (flex, solid, material)	5 Alum., Solid		5, Alum., Solid
	Diameter & projected width	508.0 mm (20.0 in.)		508.0 mm (20.0 in.)
	Ratio(fan to crnkshfl.rev.)	1.096:1		1.25:1
	Fan cutout type	Clutch		Clutch
	Drive type (direct, remote)	Serpentine Belt		Serpentine Belt
	RPM at idle (elec.)	--		--
	Motor rating(wattage)(elec)	--		--
	Motor switch (type & location)(elec.)	--		--
	Switch point (temp., pressure)(elec.)	--		--
	Fan shroud (material)	Plastic		Plastic

* - Distance Between Top Of Fins.



1
2



MVMA Specifications

Vehicle Line CAPRICE POLICE VEHICLE (SEO 9C1)
 Model Year 1990 Issued 6-89 Revised(*)

METRIC (U.S. Customary)

Engine Description	5.7 LITER V8 (350 CID) THROTTLE BODY INJECTION RPO LO5
Engine Code	

Engine - Cooling System

Coolant recovery system (std, opt, n.a.)		Standard		
Coolant fill location (rad., bottle)		Bottle, Coolant Recovery		
Radiator cap relief valve pressure [kPa (psi)]		103.4 (15.0)		
Circulation thermostat	Type (choke, bypass)	Choke		
	Starts to open @ deg's C(F)	91 (195)		
Water Pump	Type (centrifugal, other)	Centrifugal		
	GPM 1000 pump rpm	14		
	Number of pumps	1		
	Drive (V-belt, other)	Serpentine Belt		
	Bearing type	Sealed Double Row Ball		
	Impeller material	Steel		
	Housing material	Cast Iron		
By-pass recirculation (type (inter., ext.))		Internal		
Cooling system capacity	With heater - L (qt.)	15.04 (15.89)		
	With air conditioner-L(qt.)	14.97 (15.82)		
	Opt. equip.[specify-L(qt.)]	15.69 (16.58)		
Water jackets full length of cyl(yes,no)		Yes		
Water all around cylinder (yes, no)		Yes		
Water jackets open at head face (yes,no)		Yes		
Radiator core	Std., A/C, HD	AC	HD	Police
	Type (cross-flow, etc.)	Cross-Flow		
	Construction (fin & tube mechanical, braze, etc.)	Fin & Tube		
	Matl., mass (kg(wgt., lbs.))	Copper-Brass, High Efficiency Radiator		
	Width	668.0 mm	668.0 mm	668.0 mm
	Height	429.7 mm	429.7 mm	429.7 mm
	Thickness	40.2 mm	40.2 mm	40.2 mm
	Fins per inch	2.5 mm	2.5 mm	3.0 mm
Radiator end tank material				
Fan	Std., elec., opt	AC - HD		
	Number of blades & type (flex, solid, material)	5, Aluminum, Solid		
	Diameter & projected width	508.0mm (20.0 in.)		
	Ratio(fan to crnkshft.rev.)	1.25:1		
	Fan cutout type	Clutch		
	Drive type (direct, remote)	Serpentine Belt		
	RPM at idle (elec.)	---		
	Motor rating(wattage)(elec)	---		
	Motor switch (type & location) (elec.)	---		
	Switch point (temp., pressure) (elec.)	---		
	Fan shroud (material)	Plastic		

1
2

MVMA Specifications

Vehicle Line CAPRICE FLEET VEHICLE
 Model Year 1990 Issued 6-89 Revised(*) _____

METRIC (U.S. Customary)

Engine Description
 Engine Code

4.3 LITER V6 (262 CID)
 THROTTLE BODY INJECTION RPO LB4

Engine - Cooling System

Coolant recovery system (std, opt, n.a.)		Standard		
Coolant fill location (rad., bottle)		Bottle, Coolant Recovery		
Radiator cap relief valve pressure [kPa (psi)]		103.0 (15.0)		
Circulation thermostat	Type (choke, bypass)	Choke		
	Starts to open @ deg's C(F)	91 (196)		
Water Pump	Type (centrifugal, other)	Centrifugal		
	GPM 1000 pump rpm	14		
	Number of pumps	1		
	Drive (V-belt, other)	Serpentine Belt		
	Bearing type	Sealed Double Row Ball		
	Impeller material	Steel		
Housing material		Cast Iron		
By-pass recirculation (type (inter., ext.))		Internal		
Cooling system capacity	With heater - L (qt.)	15.04 (15.89)		
	With air conditioner-L(qt.)	14.97 (15.82)		
	Opt. equip.(specify-L(qt.))	15.69 (16.56)		
Water jackets full length of cy.(yes,no)		Yes		
Water all around cylinder (yes, no)		Yes		
Water jackets open at head face (yes,no)		Yes		
Radiator core	Std., A/C, HD	Standard	A/C	HD
	Type (cross-flow, etc.)	Cross-Flow		
	Construction (fin & tube mechanical, braze, etc.)	Fin & Tube		
	Matl., mass (kg/wgt., lbs.)	Copper-Brass, High Efficiency Radiator		
	Width	528.0 mm	528.0 mm	528.0 mm
	Height	429.7 mm	429.7 mm	429.7 mm
	Thickness	25.0 mm	25.0 mm	40.2 mm
	Fins per inch *	2.5 mm	2.5 mm	2.5 mm
Radiator end tank material				
Fan	Std., elec., opt.	Standard		A/C
	Number of blades & type (flex, solid, material)	4, Aluminum, Solid		5, Aluminum, Solid
	Diameter & projected width	508.0mm (20.0 in.)		508.0mm (20.0 in.)
	Ratio(fan to crnkshft.rev.)	1.096:1		1.25:1
	Fan cutout type	Clutch		Clutch
	Drive type (direct, remote)	Serpentine Belt		Serpentine Belt
	RPM at idle (elec.)	--		--
	Motor rating(wattage)(elec)	--		--
	Motor switch (type & location)(elec.)	--		--
	Switch point (temp., pressure)(elec.)	--		--
	Fan shroud (material)	Plastic		Plastic



MVMA Specifications

Vehicle Line CAPRICE
 Model Year 1990 Issued 6-89 Revised(*) 9-89

METRIC (U.S. Customary)

Engine Description	5.0 LITER V8 (305 CID)
Engine Code	4 BBL CARBURETOR RPO LV2

Engine - Cooling System

Coolant recovery system (std, opt, n.a.)		Standard	
Coolant fill location (rad., bottle)		Bottle, Coolant Recovery	
Radiator cap relief valve pressure [kPa (psi)]		104 (15)	
Circulation thermostat	Type (choke, bypass)	Choke	
	Starts to open @ deg's C(F)	91 (195)	
Water Pump	Type (centrifugal, other)	Centrifugal	
	GPM 1000 pump rpm	22	
	Number of pumps	1	
	Drive (V-belt, other)	V-Belt	
	Bearing type	Ball	
	Impeller material	Steel	
Housing material		Cast Iron	
By-pass recirculation [type (inter., ext.)]		External	
Cooling system capacity	With heater - L (qt.)	See Below	
	With air conditioner-L(qt.)	See Below	
	Opt. equip.(specify-L(qt.))	See Below	
Water jackets full length of cyl(yes,no)		Yes	
Water all around cylinder (yes, no)		Yes	
Water jackets open at head face (yes,no)		Yes	
Radiator core	Std., A/C, HD	A/C	HD
	Type (cross-flow, etc.)	Cross-Flow	
	Construction (fin & tube mechanical, braze, etc.)	Fin & Tube	
	Matl. mass (kg(wgt.),lbs.)	Copper-Brass, High Efficiency Radiator	
	Width	718.8 mm	718.8 mm
	Height	429.7 mm	429.7 mm
	Thickness	25.0 mm	40.2 mm
	Fins per inch *	20.3 mm	20.3 mm
Radiator end tank material		Copper	
Fan	Std., elec., opt.	A/C	HD
	Number of blades & type (flex, solid, material)	4-Steel, Solid	5-Aluminum, Solid
	Diameter & projected width	482.6mm (19.0 in.)	482.6 (19.0)
	Ratio(fan to crnkshft.rev.)	.85	1.4
	Fan cutout type	Clutch	Clutch
	Drive type (direct, remote)	V-Belt	V-Belt
	RPM at idle (elec.)	--	--
	Motor rating(wattage)(elec)	--	--
	Motor switch (type & location)(elec.)	--	--
	Switch point (temp., pressure)(elec.)	--	--
	Fan shroud (material)	Plastic	Plastic

* Distance Between Top Of Fins.



MVMA Specifications

Vehicle Line CAPRICE
 Model Year 1990 Issued 8-89 Revised(*) 9-89

METRIC (U.S. Customary)

Engine Description
 Engine Code

5.0 LITER V8 (305 CID)
 THROTTLE BODY INJECTION RPO L03

Engine - Fuel System (See supplemental page for details of Fuel Inj, Supercharger, Turbocharger, etc. if used)

Induction type: carburetor, fuel injection system, etc.		Fuel Injection
Manufacturer		AC/Rochester Products
Carburetor no. of barrels		Not Applicable
Idle A/F mix.		Preset - No Adjustment Provided
Fuel Injection	Point of inj. (no.)	Throttle Body
	Constant, pulse, flow	Pulse
	Control (elec., mech.)	Electronic
	Sys. press. (kPa (psi))	--
Idle spd.--rpm (spec. neutral or drive and propane if used)	Manual	--
	Automatic	--
Intake manifold heat control (exhaust or water thermostatic or fixed)		Exhaust
Air cleaner type		Replaceable Paper Element Single Snorkel
Fuel filter (type/location)		Plastic/Attaches To Inside Frame Rail/Forward Of Rear Crossmember
Fuel pump	Type (elec. or mech.)	Electric
	Location (eng., tank)	Fuel Tank
	Press. range (kPa (psi))	76 (11.02)
	Flow rate at regulated pressure (L (gal)/hr @ kPa (psi))	23-30 g/sec. @ 83 kPa

Fuel Tank

Capacity (refill L (gallons))		95 (25.0) Sedan; 83.3 (22.0) S.W.
Location (describe)		Underbody Behind Rear Axle
Attachment		Two Straps To Underbody
Material & Mass (kg (weight lbs.))		Steel, 11.680 (25.7)
Filler pipe	Location & material	Rear - Sedan; L.R. Quarter Panel - Station Wagon
	Connection to tank	Solder
Fuel line (material)		Nylon
Fuel hose (material)		Not Available
Return line (material)		Nylon
Vapor line (material)		Nylon
Extended range tank	Opt., n.a.	Not Available
	Capacity [L (gallons)]	"
	Location & material	"
	Attachment	"
Auxiliary tank	Opt., n.a.	"
	Capacity [L (gallons)]	"
	Location & material	"
	Attachment	"
	Sight switch or valve	"
Separate fill		"



MVMA Specifications

Vehicle Line CAPRICE POLICE VEHICLE (SEO 9C1)
 Model Year 1990 Issued 6-89 Revised(*)

METRIC (U.S. Customary)

Engine Description	5.0 LITER V8 (305 CID)
Engine Code	THROTTLE BODY INJECTION RPO L03

Engine - Fuel System (See supplemental page for details of Fuel Inj, Supercharger, Turbocharger, etc. if used)

Induction type: carburetor, fuel injection system, etc.		Fuel Injection
Manufacturer		AC/Rochester Products
Carburetor no. of barrels		Not Applicable
Idle A/F mix.		Preset - No Adjustment Provided
Fuel Injection	Point of inj. (no.)	Throttle Body
	Constant, pulse, flow	Pulse
	Control (elec., mech.)	Electronic
	Sys. press. (kPa (psi))	--
Idle spd. -rpm (spec. neutral or drive and propane if used)	Manual	--
	Automatic	--
Intake manifold heat control (exhaust or water thermostatic or fixed)		Exhaust
Air cleaner type		Replaceable Paper Element Single Snorkel
Fuel filter (type/location)		Plastic/Attaches To Inside Frame Rail/Forward Of Rear Crossmember
Fuel pump	Type (elec. or mech.)	Electric
	Location (eng., tank)	Fuel Tank
	Press. range (kPa (psi))	Pressure Depends On Flow Rate And System Voltage
	Flow rate at regulated pressure (L (gal)/hr @ kPa (psi))	

Fuel Tank

Capacity (refill L (gallons))		95 (25.0)
Location (describe)		Underbody Behind Rear Axle
Attachment		Two Straps To Underbody
Material & Mass (kg (weight lbs.))		Steel, 11.680 (25.7)
Filler pipe	Location & material	Rear
	Connection to tank	Solder
Fuel line (material)		Nylon
Fuel hose (material)		Not Available
Return line (material)		Nylon
Vapor line (material)		Nylon
Extended range tank	Opt., n.a.	Not Available
	Capacity [L (gallons)]	"
	Location & material	"
	Attachment	"
Auxiliary tank	Opt., n.a.	"
	Capacity [L (gallons)]	"
	Location & material	"
	Attachment	"
	Slctr switch or valve	"
Separate fill		"



MVMA Specifications

Vehicle Line CAPRICE POLICE VEHICLE (SEO 9C1)
 Model Year 1990 Issued 8-86 Revised(*)

METRIC (U.S. Customary)

Engine Description	5.7 LITER V8 (350 CID)
Engine Code	THROTTLE BODY INJECTION RPO LO5

Engine - Fuel System (See supplemental page for details of Fuel Inj, Supercharger, Turbocharger, etc. if used)

Induction type: carburetor, fuel injection system, etc.		Fuel Injection
Manufacturer		AC/Rochester Products
Carburetor no. of barrels		Not Applicable
Idle A/F mix.		Preset - No Adjustment Provided
Fuel Injection	Point of inj. (no.)	Throttle Body
	Constant, pulse, flow	Pulse
	Control (elec., mech.)	Electronic
	Sys. press. [kPa (psi)]	
Idle spd.-rpm (spec. neutral or drive and propane if used)	Manual	
	Automatic	
Intake manifold heat control (exhaust or water thermostatic or fixed)		Exhaust
Air cleaner type		Replaceable Paper Element Single Snorkel
Fuel filter (type/location)		Plastic/Attaches To Inside Frame Rail Forward Of Front Crossmember
Fuel pump	Type (elec. or mech.)	Electric
	Location (eng., tank)	Fuel Tank
	Press. range [kPa(psi)]	Pressure Depends On Flow Rate And System Voltage
	Flow rate at regulated pressure [L (gal)/hr @ kPa (psi)]	23-30 g/sec. @ 83

Fuel Tank

Capacity [refill L (gallons)]		95 (25.0)
Location (describe)		Underbody Behind Rear Axle
Attachment		Two Straps To Underbody
Material & Mass [kg (weight lbs.)]		Steel, 11.68 (25.7)
Filler pipe	Location & material	Rear
	Connection to tank	Solder
Fuel line (material)		Nylon
Fuel hose (material)		Not Available
Return line (material)		Nylon
Vapor line (material)		Nylon
Extended range tank	Opt., n.a.	Not Available
	Capacity [L (gallons)]	"
	Location & material	"
	Attachment	"
Auxiliary tank	Opt., n.a.	"
	Capacity [L (gallons)]	"
	Location & material	"
	Attachment	"
	Slctr switch or valve	"
Separate fill		"



MVMA Specifications

Vehicle Line CAPRICE FLEET VEHICLE
 Model Year 1990 Issued 6-89 Revised(*) _____

METRIC (U.S. Customary)

Engine Description **4.3 LITER V8 (262 CID)**
 Engine Code **THROTTLE BODY INJECTION RPO LB4**

Engine - Fuel System (See supplemental page for details of Fuel Inj, Supercharger, Turbocharger, etc. if used)

Induction type: carburetor, fuel injection system, etc.		Fuel Injection
Manufacturer		AC/Rochester Products
Carburetor no. of barrels		Not Applicable
Idle A/F mix.		Preset - No Adjustment Provided
Fuel Injection	Point of Inj. (no.)	Throttle body
	Constant, pulse, flow	Pulse
	Control (elec., mech.)	Electronic
	Sys. press. [kPa (psi)]	
Idle spd. -rpm (spec. neutral or drive and propane if used)	Manual	Not Available
	Automatic	Not Available
Intake manifold heat control (exhaust or water thermostatic or fixed)		Exhaust
Air cleaner type		Replaceable Paper Element, Single Snorkel
Fuel filter (type/location)		Plastic Attaches To Inside Frame Rail/Forward Of Front Crossmember
Fuel pump	Type (elec. or mech.)	Electric
	Location (eng., tank)	Fuel tank
	Press. range [kPa(psi)]	76
	Flow rate at regulated pressure (L (gal)/hr @ kPa (psi))	14.5 - 23.5 g/sec @ 83

Fuel Tank

Capacity (refill L (gallons))		95 (25.0) Sedan / 83.3 (22.0) S.W.
Location (describe)		Underbody Behind Rear Quarter
Attachment		Two Straps Underbody
Material & Mass [kg (weight lbs.)]		Steel, 11.680 (25.7)
Filter pipe	Location & material	Rear-Sedan; L.R. Quarter Panel - S.W.
	Connection to tank	Solder
Fuel line (material)		Nylon
Fuel hose (material)		Not Available
Return line (material)		Nylon
Vapor line (material)		Nylon
Extended range tank	Opt., n.a.	Not Available
	Capacity [L (gallons)]	"
	Location & material	"
	Attachment	"
Auxiliary tank	Opt., n.a.	Not Available
	Capacity [L (gallons)]	"
	Location & material	"
	Attachment	"
	Sight switch or valve	"
Separate fill		"



MVMA Specifications

Vehicle Line CAPRICE
 Model Year 1990 Issued 6-89 Revised(*) 9-89

METRIC (U.S. Customary)

Engine Description
 Engine Code

5.0 LITER V8 (305 CID)
 THROTTLE BODY INJECTION RPO L03

Vehicle Emission Control

Exhaust Emission Control	Type (air injection, engine modifications, other)		Air Injection W/Computer Command Control
	Air injection	Pump or pulse	Pump Vane
		Driven by	V-Belt
		Air distribution (head, manifold, etc.)	Exhaust Manifold And Catalytic Converter
		Point of entry	Exhaust Manifold Takedown
	Exhaust Gas Recirculation	Type (controlled flow, open orifice, other)	Pulse Width, Modulated
		Exhaust source Point of exh.inj. (spacer, carb., manifold, other)	Manifold Exhaust Crossover Inlet Manifold
	Catalytic Converter	Type	Dual Bed (Oxidizing And Reducing)
		Number of	1
		Location(s)	Beneath RF Underbody
Volume [L[<u>cu.in</u>]]		2.78 (169.8)	
Substrate type		Monolith	
Noble metal type		Platinum (Pt), Palladium (Pd), Rhodium (Rh)	
Crankcase Emission Control	Type (ventilates to atmosphere, induction system, other)		Induction System
	Energy source (manifold vacuum, carburetor, other)		Manifold Vacuum
	Discharges (to intake manifold, other)		Intake Manifold
	Air inlet (breather cap, other)		Carburetor Air Cleaner
Evaporative Emission Control	Vapor vented to crankcase, canister, other)	Fuel tank	Canister
		Carburetor	Canister
	Vapor storage provision		Canister
Electronic System	Closed loop (yes/no)		Yes
	Open loop (yes/no)		No

Engine - Exhaust System

Type (single, single with cross-over, dual, other)		Single W/ Crossover
* Muffler no. & type (reverse flow, straight thru, separate resonator) Material & Mass [kg (weight lbs.)]		1, Reverse Flow
Resonator no. & type		Not Applicable
* Exhaust pipe	Branch o.d., wall thickness	50.8 x .86 mm (2.0 x .034 in.)
	Main o.d., wall thickness	57.15 x 1.8 mm (2.25 x .071 in.)
	Matl. & Mass [kg(wght.lbs.)]	Laminated Tubing-Steel Inner, Stainless Steel Outer; Stainless Steel Tubing
* Inter-mediate pipe	o.d. & wall thickness	63.5 x 1.4 mm (2.50 x .055 in.)
	Matl. & Mass [kg(wght.lbs.)]	Aluminum Coated Steel
* Tail pipe	o.d. & wall thickness	63.5 x 1.4 mm (2.50 x .055 in.)
	Matl. & Mass [kg(wght.lbs.)]	Aluminum Coated Steel

* - Purchased as unit; 9.072 (20.0).

MVMA Specifications

Vehicle Line CAPRICE POLICE VEHICLE (SEO 9C1)
 Model Year 1990 Issued 6-89 Revised(*) 9-89

METRIC (U.S. Customary)

Engine Description **5.0 LITER V8 (305 CID)**
 Engine Code **THROTTLE BODY INJECTION RPO L03**

Vehicle Emission Control

Exhaust Emission Control	Type (air injection, engine modifications, other)		Air Injection W/Computer Command Control
	Air Injection	Pump or pulse	Pump Vane
		Driven by	V-Belt
		Air distribution (head, manifold, etc..)	Exhaust Manifold And Catalytic Converter
		Point of entry	Exhaust Manifold Takedown
	Exhaust Gas Recirculation	Type (controlled flow, open orifice, other)	Pulse Width, Modulated
		Exhaust source	Manifold Exhaust Crossover
		Point of exh.inj. (spacer, carb., manifold, other)	Inlet Manifold
	Catalytic Converter	Type	Dual Bed (Oxidizing And Reducing)
		Number of	1
Location(s)		Beneath RF Underbody	
Volume [L(cu.in)]		2.78 (169.8)	
Substrate type		Monolith	
Noble metal type		Platinum (Pt), Palladium (Pd), Rhodium (Rh)	
Crankcase Emission Control	Type (ventilates to atmosphere, induction system, other)		PCV - Air Cleaner
	Energy source (manifold vacuum, carburetor, other)		Manifold Vacuum
	Discharges (to intake manifold, other)		Intake Manifold
	Air Int.(breather cap,other)		Rocker Cover
	Evaporative Emission Control	Vapor vented to crankcase, canister,other	Fuel tank Carburetor
Vapor storage provision		Canister	
Closed loop (yes/no)		Yes	
Electronic System	Open loop (yes/no)		No

Engine - Exhaust System

Type (single, single with cross-over, dual, other)		Single W/ Crossover
Muffler no. & type (reverse flow, straight thru, separate resonator) Material & Mass [kg (weight lbs.)]		1, Reverse Flow
Resonator no. & type		Not Applicable
Exhaust pipe	Branch o.d., wall thickness	50.8 x .86 mm (2.0 x .034 in.)
	Main o.d., wall thickness	57.15 x 1.8 mm (2.25 x .071 in.)
	Matl. & Mass [kg(wght.lbs.)]	Laminated Tubing-Steel Inner, Stainless Steel Outer; Stainless Steel Tubing
Inter-mediate pipe	o.d. & wall thickness	63.5 x 1.4 mm (2.50 x .055 in.)
	Matl. & Mass [kg(wght.lbs.)]	Aluminum Coated Steel
Tail pipe	o.d. & wall thickness	63.5 x 1.4 mm (2.50 x .055 in.)
	Matl. & Mass [kg(wght.lbs.)]	Aluminum Coated Steel



MVMA Specifications

Vehicle Line CAPRICE POLICE VEHICLE (SEO 9C1)
 Model Year 1990 Issued 8-89 Revised(*) 9-89

METRIC (U.S. Customary)

Engine Description
 Engine Code

5.7 LITER V8 (350 CID)
 THROTTLE BODY INJECTION RPO L05

Vehicle Emission Control

Exhaust Emission Control	Type (air injection, engine modifications, other)		Air Injection With Computer Control
	Air Injection	Pump or pulse	Pump
		Driven by	Accessory Drive Belt
		Air distribution (head, manifold, etc.)	Exhaust Manifold And Catalytic Converter
		Point of entry	Exhaust Manifold
	Exhaust Gas Recirculation	Type (controlled flow, open orifice, other)	Backpressure Valve
		Exhaust source	
		Point of exh.inj. (spacer, carb., manifold, other)	Intake Manifold Passage
	Catalytic Converter	Type	Dual Bed Monolith
		Number of	1
Location(s)		Under Floor	
Volume [L(cu.in)]		2.78 (169.8)	
Substrate type		Ceramic	
Noble metal type		Platinum (Pt), Palladium (Pd), Rhodium (Rh)	
Crankcase Emission Control	Type (ventilates to atmosphere, induction system, other)		PCV - Air Cleaner
	Energy source (manifold vacuum, carburetor, other)		Manifold Vacuum
	Discharges (to intake manifold, other)		TBI Unit
	Air inlet (breather cap, other)		Rocker Cover
Evaporative Emission Control	Vapor vented to crankcase, canister, other)	Fuel tank	Canister
		Carburetor	Not Applicable
	Vapor storage provision		Canister
Electronic System	Closed loop (yes/no)		Yes
	Open loop (yes/no)		No

Engine - Exhaust System

Type (single, single with cross-over, dual, other)		Single W/Crossover
Muffler no. & type (reverse flow, straight thru, separate resonator) Material & Mass [kg (weight lbs.)]		1, Reverse Flow
Resonator no. & type		Not Applicable
Exhaust pipe	Branch o.d., wall thickness	50.8 x .86 mm (2.0 x .034 in.)
	Main o.d., wall thickness	57.15 x 1.8 mm (2.25 x .071 in.)
	Matl. & Mass [kg(wght.lbs.)]	Laminated Tubing-Steel Inner, Stainless Steel Outer; Stainless Steel Tubing
Inter-mediate pipe	o.d. & wall thickness	63.5 x 1.4 mm (2.50 x .055 in.)
	Matl. & Mass [kg(wght.lbs.)]	Aluminum Coated Steel
Tail pipe	o.d. & wall thickness	63.5 x 1.4 mm (2.50 x .055 in.)
	Matl. & Mass [kg(wght.lbs.)]	Aluminum Coated Steel



MVMA Specifications

Vehicle Line CAPRICE FLEET VEHICLE
 Model Year 1990 Issued 6-89 Revised(*) 9-89

METRIC (U.S. Customary)

Engine Description
 Engine Code

4.3 LITER V6 (262 CID)
 THROTTLE BODY INJECTION RPO LB4

Vehicle Emission Control

Exhaust Emission Control	Type (air injection, engine modifications, other)		Air Injector With Computer Control Command
	Air Injection	Pump or pulse	Pump
		Driven by	
		Air distribution (head, manifold, etc.)	Exhaust Manifold And Catalytic Converter
		Point of entry	Exhaust Manifold
	Exhaust Gas Recirculation	Type (controlled flow, open orifice, other)	
		Exhaust source	
		Point of exh.inj. (spacer, carb., manifold, other)	Manifold, Beneath TBI
	Catalytic Converter	Type	Dual Bed Monolith
		Number of	1
		Location(s)	Beneath Right Front Underbody
		Volume [L(cu.in)]	2.78 (170)
		Substrate type	Monolith
		Noble metal type	
Crankcase Emission Control	Type (ventilates to atmosphere, induction system, other)		PCV - Air Cleaner Induction System
	Energy source (manifold vacuum, carburetor, other)		Manifold Vacuum
	Discharges (to intake manifold, other)		Intake Manifold
	Air inlt(breather cap, other)		Rocker Cover
Evaporative Emission Control	Vapor vented to crankcase, canister, other)	Fuel tank	Canister
		Carburetor	Not Applicable
	Vapor storage provision		Canister
Electronic System	Closed loop (yes/no)		Yes
	Open loop (yes/no)		No

Engine - Exhaust System

Type (single, single with cross-over, dual, other)		Single
Muffler no. & type (reverse flow, straight thru, separate resonator) Material & Mass (kg (weight lbs.))		1, Reverse Flow, 8.79 (19.4)
Resonator no. & type		Not Applicable
Exhaust pipe	Branch o.d., wall thickness	Not Available
	Main o.d., wall thickness	57.15 x 1.4mm (2.25 x .05 in.)
	Matl. & Mass (kg(wght.lbs.))	Aluminum Coated Steel
Inter-mediate pipe	o.d. & wall thickness	57.15 x 1.4mm (2.25 x .05 in.)
	Matl. & Mass (kg(wght.lbs.))	Steel
Tail pipe	o.d. & wall thickness	50.8 x 1.1mm (2.0 x .04 in.)
	Matl. & Mass (kg(wght.lbs.))	Aluminum Coated Steel



MVMA Specifications

Vehicle Line CAPRICE
 Model Year 1990 Issued 6-89 Revised(*) 9-89

METRIC (U.S. Customary)

Engine Description
 Engine Code

5.0 LITER V8 (307 CID)
 4-BBL CARBURETOR RPO LV2

Vehicle Emission Control

Exhaust Emission Control	Type (air injection, engine modifications, other)		Air, Injection W/Computer Command Control
	Air injection	Pump or pulse	Pump Vane
		Driven by	V-Belt
		Air distribution (head, manifold, etc.)	Cylinder Head And Catalytic Converter
		Point of entry	Exhaust Port And Catalytic Converter
	Exhaust Gas Recirculation	Type (controlled flow, open orifice, other)	Variable Orifice - Backpressure
		Exhaust source	Crossover In Intake Manifold
		Point of exh.inj. (spacer, carb., manifold, other)	Intake Manifold
	Catalytic Converter	Type	Dual Bed Monolith
		Number of	1
		Location(s)	Beneath RF Underbody
		Volume [L(cu.in)]	2.8 (170)
		Substrate type	Monolith
		Noble metal type	Platinum (Pt), Palladium (Pd), Rhodium (Rh)
Noble metal concentration (g/cu. cm.)			
Crankcase Emission Control	Type (ventilates to atmosphere, induction system, other)		Positive Crankcase Ventilation (Induction)
	Energy source (manifold vacuum, carburetor, other)		Manifold Vacuum
	Discharges (to intake manifold, other)		Intake Manifold
	Air inlt.(breather cap, other)		Ventilation Filter In L.H. Valve Cover
Evaporative Emission Control	Vapor vented to crankcase, canister, other)	Fuel tank	Canister
		Carburetor	Canister
	Vapor storage provision		Canister
Electronic System	Closed loop (yes/no)		Yes
	Open loop (yes/no)		No

Engine - Exhaust System

Type (single, single with cross-over, dual, other)		Single W/Crossover
Muffler no. & type (reverse flow, straight thru, separate resonator) Material & Mass (kg (weight lbs.))		* 1, Reverse Flow
Resonator no. & type		Not Applicable
Exhaust pipe	* Branch o.d., wall thickness	50.8 x .86 mm (2.0 x .034 in.)
	Main o.d., wall thickness	57.15 x 1.8 mm (2.25 x .071 in.)
	Matl. & Mass (kg(wght.lbs.))	Laminated Tubing-Steel Inner, Stainless Steel Outer; Stainless Steel Tubing
Inter-mediate pipe	* o.d. & wall thickness	57.15 x 1.8mm (2.25 x .071 in.)
	Matl. & Mass (kg(wght.lbs.))	Aluminum Coated Steel
Tail pipe	* o.d. & wall thickness	63.5 x 1.4mm (2.50 x .071 in.)
	Matl. & Mass (kg(wght.lbs.))	Aluminum Coated Steel Tubing (A)

(A) - LV2 3.231 (7.1)

* - Purchased As Unit; 7.439 (16.4)



MVMA Specifications

Vehicle Line CAPRICE / CAPRICE POLICE VEHICLE (SEO 9C1)
 Model Year 1990 Issued 6-89 Revised(*) _____

METRIC (U.S. Customary)

Engine Description **5.0 LITER V8 (305 CID)**
 Engine Code **THROTTLE BODY INJECTION RPO L03**

Transmissions/Transaxle (Std., Opt., N.A.) (NOT APPLICABLE)

Manual 3-speed (manufacturer/country)	
Manual 4-speed (manufacturer/country)	
Manual 5-speed (manufacturer/country)	
Automatic (manufacturer/country)	
Auto. overdrive (manufacturer/country)	

Manual Transmission/Transaxle (NOT APPLICABLE)

Number of forward speeds		
Gear ratios	1st	
	2nd	
	3rd	
	4th	
	5th	
	Reverse	
Synchronous meshing (specify gears)		
Shift lever location		
Trans. case mat'l. & mass kg (lbs)*		
Lubricant	Capacity [L (pt.)]	
	Type recommended	

Clutch (Manual Transmission) (NOT APPLICABLE)

Clutch manufacturer		
Clutch type (dry, wet; single, multiple disc)		
Linkage (hyd., cable, rod, lever, other)		
Max. pedal effort (nom. spring load, new) N (lbs.)	Depressed	
	Released	
Assist (spring, power/percent, nominal)		
Type pressure plate springs		
Total spring load (nominal, new) N(lbs)		
Clutch facing	Facing mfr. & matl. coding	
	Facing matl. & construction	
	Rivets per facing	
	Outside x inside dia. (nom.)	
	Total eff.area(sq cm(sq in))	
	Thickness (pressure plate side/fly wheel side)	
	Rivet depth (pressure plate side/fly wheel side)	
Engagement cushion method		
Release bearing type & method lub.		
Torsional damping method, springs, hysteresis		

* Includes shift linkage, lubricant, and clutch housing. If other specify.



MVMA Specifications

Vehicle Line CAPRICE POLICE VEHICLE (SEO 9C1)
 Model Year 1990 Issued 6-89 Revised(*)

METRIC (U.S. Customary)

Engine Description
 Engine Code

5.7 LITER V8 (350 CID)
 THROTTLE BODY INJECTION RPO L05

Transmissions/Transaxle (Std., Opt., N.A.)

Manual 3-speed (manufacturer/country)	Not Applicable
Manual 4-speed (manufacturer/country)	"
Manual 5-speed (manufacturer/country)	"
Automatic (manufacturer/country)	"
Auto, overdrive (manufacturer/country)	Standard, (Hydra-Matic/U.S.A.)

Manual Transmission/Transaxle (NOT APPLICABLE)

Number of forward speeds		
Gear ratios	1st	
	2nd	
	3rd	
	4th	
	5th	
	Reverse	
Synchronous meshing (specify gears)		
Shift lever location		
Trans. case mat'l. & mass kg (lbs)*		
Lubricant	Capacity [L. (pt.)]	
	Type recommended	

Clutch (Manual Transmission) (NOT APPLICABLE)

Clutch manufacturer		
Clutch type (dry, wet; single, multiple disc)		
Linkage (hyd., cable, rod, lever, other)		
Max. pedal effort (nom. sprung load, new) N (lbs.)	Depressed	
	Released	
Assist (spring, power/percent, nominal)		
Type pressure plate springs		
Total spring load (nominal, new) N(lbs)		
Clutch facing	Facing mfr. & matl. coding	
	Facing matl. & construction	
	Rivets per facing	
	Outside x inside dia. (nom.)	
	Total eff. area [sq cm (sq in)]	
	Thickness (pressure plate side/fly wheel side)	
	Rivet depth (pressure plate side/fly wheel side)	
Engagement cushion method		
Release bearing type & method lub.		
Torsional damping method, springs, hysteresis		

* Includes shift linkage, lubricant, and clutch housing. If other specify.

MVMA Specifications

Vehicle Line CAPRICE FLEET VEHICLE
 Model Year 1990 Issued 6-89 Revised(*) _____

METRIC (U.S. Customary)

Engine Description **4.3 LITER V6 (262 CID)**
 Engine Code **THROTTLE BODY INJECTION RPO LB4**

Transmissions/Transaxle (Std., Opt., N.A.)

Manual 3-speed (manufacturer/country)	Not Applicable
Manual 4-speed (manufacturer/country)	"
Manual 5-speed (manufacturer/country)	"
Automatic (manufacturer/country)	"
Auto, overdrive (manufacturer/country)	Standard, (Hydra-Matic/USA)

Manual Transmission/Transaxle (NOT APPLICABLE)

Number of forward speeds		
Gear ratios	1st	
	2nd	
	3rd	
	4th	
	5th	
	Reverse	
Synchronous meshing (specify gears)		
Shift lever location		
Trans. case mat'l. & mass kg (lbs)*		
Lubricant	Capacity [L (pt.)]	
	Type recommended	

Clutch (Manual Transmission) (NOT APPLICABLE)

Clutch manufacturer		
Clutch type (dry, wet; single, multiple disc)		
Linkage (hyd., cable, rod, lever, other)		
Max. pedal effort (nom. spring load, new) N (lbs.)	Depressed	
	Released	
Assist (spring, power/percent, nominal)		
Type pressure plate springs		
Total spring load (nominal, new) N(lbs)		
Clutch facing	Facing mfr. & matl. coding	
	Facing matl. & construction	
	Rivets per facing	
	Outside x inside dia. (nom.)	
	Total eff. area(sq cm(sq in))	
	Thickness (pressure plate side/fly wheel side)	
	Rivet depth (pressure plate side/fly wheel side)	
Engagement cushion method		
Release bearing type & method lub.		
Torsional damping method, springs, hysteresis		

* Includes shift linkage, lubricant, and clutch housing. If other specify.



MVMA Specifications

Vehicle Line CAPRICE
 Model Year 1990 Issued 6-89 Revised(*) _____

METRIC (U.S. Customary)

Engine Description
 Engine Code

5.0 LITER V8 (307 CID)
 4-BBL CARBURETOR RPO LV2

Transmissions/Transaxle (Std., Opt., N.A.)

Manual 3-speed (manufacturer/country)	Not Applicable
Manual 4-speed (manufacturer/country)	"
Manual 5-speed (manufacturer/country)	"
Automatic (manufacturer/country)	"
Auto, overdrive (manufacturer/country)	Standard, (Hydra-Matic/U.S.A.)

Manual Transmission/Transaxle (NOT APPLICABLE)

Number of forward speeds		
Gear ratios	1st	
	2nd	
	3rd	
	4th	
	5th	
	Reverse	
Synchronous meshing (specify gears)		
Shift lever location		
Trans. case mat'l. & mass kg (lbs)*		
Lubricant	Capacity [L (pt.)]	
	Type recommended	

Clutch (Manual Transmission) (NOT APPLICABLE)

Clutch manufacturer		
Clutch type (dry, wet; single, multiple disc)		
Linkage (hyd., cable, rod, lever, other)		
Max. pedal effort (nom. spring load, new) N (lbs.)	Depressed	
	Released	
Assist (spring, power/percent, nominal)		
Type pressure plate springs		
Total spring load (nominal, new) N(lbs)		
Clutch facing	Facing mfr. & matl. coding	
	Facing matl. & construction	
	Rivets per facing	
	Outside x inside dia. (nom.)	
	Total eff. area [sq cm (sq in)]	
	Thickness (pressure plate side/fly wheel side)	
	Rivet depth (pressure plate side/fly wheel side)	
Engagement cushion method		
Release bearing type & method lub.		
Torsional damping method, springs, hysteresis		

* Includes shift linkage, lubricant, and clutch housing. If other specify.



MVMA Specifications

Vehicle Line CAPRICE
 Model Year 1990 Issued 6-89 Revised(*) 9-89

METRIC (U.S. Customary)

Engine Description **5.0 LITER V8 (305 CID)**
 Engine Code **THROTTLE BODY INJECTION RPO L03**

Automatic Transmission/Transaxle (See Power Teams for Transmission Usage)

Trade Name		200-4R
Type and special features (describe)		4-Speed Automatic Torque Converter With Planetary Gears
Gear selector	Location (column, floor, other)	Steering Column
	Ltr./No. designation (e.g. PRND21)	P-R-N- (D) -D-2-1
	Shift interlock (yes, no, describe)	
Gear ratios	1st	2.74
	2nd	1.57
	3rd	1.00***
	4th	0.67***
	Reverse	2.07
Max. upshift speed - drive range [km/h (mph)]		Not Available
Max. kickdown speed - drive range [km/h (mph)]		"
Min. overdrive speed [km/h (mph)]		"
Torque converter	Number of elements	3
	Max. ratio at stall	Not Available
	Type of cooling (air, liquid)	Liquid
	Nominal diameter	298 (11.75)
Lubricant	Capacity (refill L(pt.))	3.0 (6.3)
	Type recommended	Dexron II
Oil cooler (std., opt., N.A., internal, external, air, liquid)		Standard, Integral With Radiator
Trans. mass [kg(lbs)] & case matl.**		Aluminum

All Wheel / 4 Wheel Drive (NOT APPLICABLE)

Desc. & type (part-time, full-time, 2/4 shift while moving, mech., elect., chain/gear, etc.)		
Transfer case	Manufacturer and model	
	Type and location	
Low-range gear ratio		
System disconnect (describe)		
Center differential	Type (bevel, planetary, w or w/o viscous bias, torson, etc.)	
	Torque split(% frt/rear)	

* Input speed / square root of torque.
 ** Dry weight including torque converter. If other, specify.
 *** Converter Clutch Engagement.



MVMA Specifications

Vehicle Line CAPRICE POLICE VEHICLE (SEO 9C1)
 Model Year 1990 Issued 8-89 Revised(*) 8-89

METRIC (U.S. Customary)

Engine Description
 Engine Code

5.0 LITER V8 (305 CID)
 THROTTLE BODY INJECTION RPO L03

○ Automatic Transmission/Transaxle (See Power Teams for Transmission Usage)

Trade Name		200-4R
Type and special features (describe)		4-Speed Automatic Torque Converter With Planetary Gears
Gear selector	Location (column, floor, other)	Steering Column
	Ltr./No. designation (e.g. PRND21)	P-R-N- (D) -2-1
	Shift interlock (yes, no, describe)	
Gear ratios	1st	2.74
	2nd	1.57
	3rd	1.00***
	4th	0.67***
	Reverse	2.07
Max. upshift speed - drive range [km/h (mph)]		Not Available
Max. kickdown speed - drive range [km/h (mph)]		"
Min. overdrive speed [km/h (mph)]		"
Torque converter	Number of elements	3
	Max. ratio at stall	Not Available
	Type of cooling (air, liquid)	Liquid
	Nominal diameter	298 (11.75)
	Capacity factor "K"	
Lubricant	Capacity (refill L(pt.))	3.0 (6.3)
	Type recommended	Dexron II
Oil cooler (std., opt., N.A., internal, external, air, liquid)		Standard, Integral With Radiator
Trans. mass [kg(lbs)] & case matl.**		Aluminum

○ All Wheel / 4 Wheel Drive (NOT APPLICABLE)

Desc. & type (part-time, full-time, 2/4 shift while moving, mech., elect., chain/gear, etc.)		
Transfer case	Manufacturer and model	
	Type and location	
Low-range gear ratio		
System disconnect (describe)		
Center differential	Type (bevel, planetary, w or w/o viscous bias, torsen, etc.)	
	Torque split(% frt/rear)	

* Input speed / square root of torque.

** Dry weight including torque converter. If other, specify.

*** Converter Clutch Engagement.



MVMA Specifications

Vehicle Line CAPRICE POLICE VEHICLE (SEO 9C1)
 Model Year 1990 Issued 6-89 Revised(*) 9-89

METRIC (U.S. Customary)

Engine Description **6.7 LITER V8 (350 CID)**
 Engine Code **THROTTLE BODY INJECTION RPO LO5**

○ Automatic Transmission/Transaxle

Trade Name		Hydra-Matic 700-R4 (4L60)
Type and special features (describe)		4-Speed Overdrive Automatic With Lock-up Converter Clutch
Gear selector	Location (column, floor, other)	Column
	Ltr./No. designation (e.g. PRND21)	P-R-N [Ⓧ] D-2-1
	Shift interlock (yes, no, describe)	No
Gear ratios	1st	3.06
	2nd	1.63
	3rd	1.00***
	4th	0.70***
	Reverse	2.29
Max. upshift speed - drive range [km/h (mph)]		1-2 [53 (33)] 2-3 [98 (61)] 3-4 [161 (100)]
Max. kickdown speed - drive range [km/h (mph)]		3-2 [60 (50)] 2-1 [51 (32)]
Min. overdrive speed [km/h (mph)]		50 (31)
Torque converter	Number of elements	3
	Max. ratio at stall	2.15
	Type of cooling (air, liquid)	Liquid
	Nominal diameter	298mm (11.73 in.)
	Capacity factor "K"	115
Lubricant	Capacity (refill L(pt.))	4.7 (10)
	Type recommended	Dexron II ATF
Oil cooler (std., opt., N.A., internal, external, air, liquid)		In Radiator (Standard)
Trans. mass [kg(lbs)] & case matl.**		74.20 (163.5)

○ All Wheel / 4 Wheel Drive (NOT APPLICABLE)

Desc. & type (part-time, full-time, 2/4 shift while moving, mech., elect., chain/gear, etc.)		
Transfer case	Manufacturer and model	
	Type and location	
Low-range gear ratio		
System disconnect (describe)		
Center differential	Type (bevel, planetary, w or w/o viscous bias, torsen, etc.)	
	Torque split(% frt/rear)	

* Input speed / square root of torque.
 ** Dry weight including torque converter. If other, specify.

*** Converter Clutch Engagement.



MVMA Specifications

Vehicle Line CAPRICE FLEET VEHICLE
 Model Year 1990 Issued 6-89 Revised(*) 9-89

METRIC (U.S. Customary)

Engine Description
 Engine Code

4.3 LITER V6 (262 CID)
 THROTTLE BODY INJECTION RPO LB4

Automatic Transmission/Transaxle

Trade Name		Hydra-Matic 700-R4 (4L80)
Type and special features (describe)		4-Speed Overdrive Automatic with Lock-Up Converter Clutch
Gear selector	Location (column, floor, other)	Column
	Ltr./No. designation (e.g. PRND21)	P-R-N-D-D-2-1
	Shift interlock (yes, no, describe)	No
Gear ratios	1st	3.06
	2nd	1.63
	3rd	1.00***
	4th	0.70***
	Reverse	2.29
Max. upshift speed - drive range [km/h (mph)]		1-2 [50 (31)] 2-3 [100 (62)]
Max. kickdown speed - drive range [km/h (mph)]		3-2 [50 (31)] 2-3 [100 (62)]
Min. overdrive speed [km/h (mph)]		63 (39)
Torque converter	Number of elements	3
	Max. ratio at stall	1.91:1
	Type of cooling (air, liquid)	Liquid
	Nominal diameter	298mm
	Capacity factor "K"	100
Lubricant	Capacity (refill L[pt.])	4.7 (10)
	Type recommended	Dexron II ATF
Oil cooler (std., opt., N.A., internal, external, air, liquid)		
Trans. mass [kg(lbs)] & case matl.**		74.20 (163.5)

All Wheel / 4 Wheel Drive (NOT APPLICABLE)

Desc. & type (part-time, full-time, 2/4 shift while moving, mech., elect., chain/gear, etc.)		
Transfer case	Manufacturer and model	
	Type and location	
Low-range gear ratio		
System disconnect (describe)		
Center differential	Type (bevel, planetary, w or w/o viscous bias, torsen, etc.)	
	Torque split(% frt/rear)	

* Input speed / square root of torque.
 ** Dry weight including torque converter. If other, specify.

*** Converter Clutch Engagement



MVMA Specifications

Vehicle Line CAPRICE
 Model Year 1990 Issued 6-89 Revised(*) 9-89

METRIC (U.S. Customary)

Engine Description **5.0 LITER V8 (307 CID)**
 Engine Code **4-BBL CARBURETOR RPO LV2**

Automatic Transmission/Transaxle (See Power Teams for Transmission Usage)

Trade Name		200-4R
Type and special features (describe)		4-Speed Automatic Torque Converter With Planetary Gears
Gear selector	Location (column, floor, other)	Steering Column
	Ltr./No. designation (e.g. PRND21)	P-R-N- D -2-1
	Shift interlock (yes, no, describe)	
Gear ratios	1st	2.74
	2nd	1.57
	3rd	1.00***
	4th	0.67***
	Reverse	2.07
Max. upshift speed - drive range [km/h (mph)]		81 (38), 105 (65)
Max. tickdown speed - drive range [km/h (mph)]		47 (29), 87 (54), 129 (80)
Min. overdrive speed [km/h (mph)]		38
Torque converter	Number of elements	3
	Max. ratio at stall	1.9
	Type of cooling (air, liquid)	Liquid
	Nominal diameter	298.5 (11.75)
	Capacity factor "K" [™]	85 (2.93) 98 (3.23)
Lubricant	Capacity (refill L (pt.))	5L
	Type recommended	Dexron II
Oil cooler (std., opt., N.A., internal, external, air, liquid)		Standard Integral With Radiator
Trans. mass [kg(lbs)] & case matl. [™]		Aluminum, 71.2 (157)

All Wheel / 4 Wheel Drive (NOT APPLICABLE)

Desc. & type (part-time, full-time, 2/4 shift while moving, mech., elect., chain/gear, etc.)		
Transfer case	Manufacturer and model	
	Type and location	
Low-range gear ratio		
System disconnect (describe)		
Center differential	Type (bevel, planetary, w or w/o viscous bias, torsen, etc.)	
	Torque split(% frt/rear)	

* Input speed / square root of torque.
 ** Dry Weight including torque converter. If other, specify.

*** Converter Clutch Engagement.



MVMA Specifications

Vehicle Line CAPRICE / CAPRICE POLICE VEHICLE (SEO 9C1)
 Model Year 1990 Issued 6-89 Revised(*) 9-89

METRIC (U.S. Customary)

Engine Description
 Engine Code

5.0 LITER V8 (305 CID)
 THROTTLE BODY INJECTION RPO L03

○ Axle Ratio and Tooth Combinations (See 'Power Teams' for axle ratio usage)

Axle ratio (or overall top gear ratio)		2.73 (1.83)	3.08 (2.08)
Ring gear o.d.		7.50	8.50
No. of teeth	Pinion	15	13
	Ring gear	41	40

○ Rear Axle Unit

Description		Semi-Floating Axle, Overhung Hypoid Drive Pinion And Ring Gear	
Limited slip differential (type)		Disc Clutch	
Drive pinion	Type	Hypoid Gear	
	Offset	44.0 (1.75)	
No. of differential pinions		2	
Pinion/differential	Adjustment (shim, etc.)	Shim	
	Bearing adjustment	Collapsible Sleeve	
Driving wheel bearing (type)		Direct Or Single Row Cylindrical	
Lubricant	Capacity (L (pt.))	1.85 (3.5)	2.0 (4.2)
	Type recommended	GL-5 Gear Lubricant	

○ Propeller Shaft - Rear Wheel Drive

Manufacturer Type (straight tube, tube-in-tube, internal-external damper, etc.)		Straight Tube	
Outer diam. x length* x wall thickness	Manual 3-speed transmission	Not Available	
	Manual 4-speed transmission	"	
	Manual 5-speed transmission	"	
	Overdrive	"	
	Automatic transmission	(a)	
Inter-mediate bearing	Type (plain, anti-friction)	None	
	Lub. (fitting, prepack)	None	
Slip yoke	Type	Splined	
	Number of teeth	27	
	Spline o.d.	29.858 (1.175)	
Universal joints	Make and mfg. no.	Front	Saginaw Division, 44
		Rear	Saginaw Division, 44
	Number used	2	
	Type (ball and trunnion, cross)	Cross	
	Rr. attach (u-bolt, clamp, etc)	Strap & Bolt	
	Bearing	Type (plain, anti-friction)	Anti-Friction
Lubrication (fitting, prepack)		Prepacked	
Drive taken through (torque tube, arms or springs)		Control Arm	
Torque taken through (torque tube, arms or springs)		Control Arm	

* Centerline to centerline of universal joints, or to centerline of attachment.

(a) 69.9 (2.75) x 1484.9 (58.5) x 1.65 (.065) L03 & 200-4R & 7.5" Axle
 76.2 (3.0) x 1454.7 (57.3) x 1.65 (.065) L03 & 200-4R & 8.5" Axle



MVMA Specifications

Vehicle Line CAPRICE POLICE VEHICLE (SEO 9C1)
 Model Year 1990 Issued 6-89 Revised(*) 9-89

METRIC (U.S. Customary)

Engine Description	5.7 LITER V8 (350 CID)
Engine Code	THROTTLE BODY INJECTION RPO L05

○ Axle Ratio and Tooth Combinations (See 'Power Teams' for axle ratio usage)

Axle ratio (for overall top gear ratio)		3.42 (2.38)
Ring gear o.d.		8.50
No. of teeth	Pinion	12
	Ring gear	41

○ Rear Axle Unit

Description		Semi-Floating Axle, Overhung Hypoid Drive Pinion And Ring Gear
Limited slip differential (type)		Disc Clutch
Drive pinion	Type	Hypoid Gear
	Offset	44.0 (1.75)
No. of differential pinions		2
Pinion/differential	Adjustment (shim, etc.)	Shim
	Bearing adjustment	Collapsible Sleeve
Driving wheel bearing (type)		Direct Or Single Row Cylindrical
Lubricant	Capacity [L (pt.)]	2.0 (4.2)
	Type recommended	GL-5 Gear Lubricant

○ Propeller Shaft - Rear Wheel Drive

Manufacturer Type (straight tube, tube-in-tube, internal-external damper, etc.)		Straight Tube		
Outer diam. x length* x wall thickness	Manual 3-speed transmission	Not Available		
	Manual 4-speed transmission	"		
	Manual 5-speed transmission	"		
	Overdrive	"		
	Automatic transmission	(a)		
Inter-mediate bearing	Type (plain, anti-friction)	None		
	Lub. (fitting, prepack)	None		
Slip yoke	Type	Splined		
	Number of teeth	27		
	Spline o.d.	29.858 (1.175)		
Universal joints	Make and mfg. no.	Front	Saginaw Division, 44	
		Rear	Saginaw Division, 44	
	Number used		2	
	Type (ball and trunnion, cross)		Cross	
	Rr. attach (u-bolt, clamp, etc)		Strap & Bolt	
Bearing	Type (plain, anti-friction)	Anti-Friction		
	Lubrication (fitting, prepack)	Prepacked		
Drive taken through (torque tube, arms or springs)		Control Arm		
Torque taken through (torque tube, arms or springs)		Control Arm		

* Centerline to centerline of universal joints, or to centerline of attachment.

(a) 76.2 (3.0) x 1384.0 (54.5) x 1.65 (.065) L05 & LB4 & MD8 & 8.5" Axle



MVMA Specifications

Vehicle Line CAPRICE FLEET VEHICLE
 Model Year 1990 Issued 8-89 Revised(*) 8-89

METRIC (U.S. Customary)

Engine Description
 Engine Code

4.3 LITER V6 (262 CID)
 THROTTLE BODY INJECTION RPO LB4

○ Axle Ratio and Tooth Combinations (See 'Power Teams' for axle ratio usage)

Axle ratio (or overall top gear ratio)		2.56 (1.80)	3.08 (2.18)
Ring gear o.d.		7.50	8.50
No. of teeth	Pinion	18	13
	Ring gear	41	40

○ Rear Axle Unit

Description		Semi-Floating Axle, Overhung Hypoid Drive Pinion And Ring Gear	
Limited slip differential (type)		Disc Clutch	
Drive pinion	Type	Hypoid Gear	
	Offset	44.0 (1.75)	
No. of differential pinions		2	
Pinion/differential	Adjustment (shim, etc.)	Shim	
	Bearing adjustment	Collapsible Sleeve	
Driving wheel bearing (type)		Direct Or Single Row Cylindrical	
Lubricant	Capacity [L (pt.)]	1.65 (3.5)	2.0 (4.2)
	Type recommended	GL-5 Gear Lubricant	

○ Propeller Shaft - Rear Wheel Drive

Manufacturer Type (straight tube, tube-in-tube, internal-external damper, etc.)		Straight Tube	
Outer diam. x length* x wall thickness	Manual 3-speed transmission	Not Available	
	Manual 4-speed transmission	"	
	Manual 5-speed transmission	"	
	Overdrive	"	
	Automatic transmission	(a)	
Inter-mediate bearing	Type (plain, anti-friction)	None	
	Lub. (fitting, prepack)	None	
Slip yoke	Type	Splined	
	Number of teeth	27	
	Spline o.d.	29.858 (1.175)	
Universal joints	Make and mfg. no.	Front	Saginaw Division, 44
		Rear	Saginaw Division, 44
	Number used	2	
	Type (ball and trunnion, cross)	Cross	
	Rr. attach (u-bolt, clamp, etc)	Strap & Bolt	
	Bearing	Type (plain, anti-friction)	Anti-Friction
Lubrication (fitting, prepack)		Prepacked	
Drive taken through (torque tube, arms or springs)		Control Arm	
Torque taken through (torque tube, arms or springs)		Control Arm	

* Centerline to centerline of universal joints, or to centerline of attachment.

- (a) 76.2 (3.0) x 1384.0 (54.5) x 1.65 (.065) LB4 & MD8 & 8.5" Axle
 76.2 (3.0) x 1410.7 (55.5) x 1.65 (.065) LB4 and 200-4R & 7.5" Axle

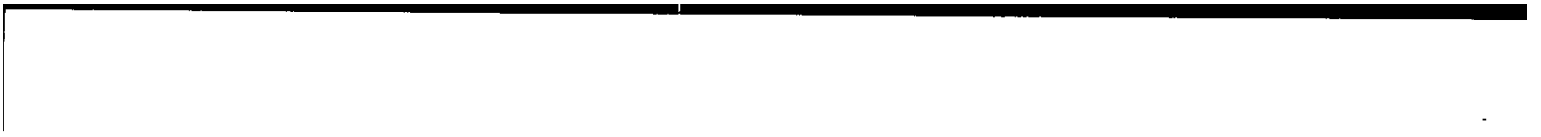

MVMA Specifications

Vehicle Line CAPRICE
 Model Year 1990 Issued 6-89 Revised(*) 9-89

METRIC (U.S. Customary)

Engine Description	5.0 LITER V8 (307 CID)
Engine Code	THROTTLE BODY INJECTION RPO LV2

○ Axle Ratio and Tooth Combinations (See 'Power Teams' for axle ratio usage)

Axle ratio (or overall top gear ratio)		2.93 (1.96)	3.23 (2.16)
Ring gear o.d.		8.50	8.50
No. of teeth	Pinion	14	13
	Ring gear	41	42

○ Rear Axle Unit

Description		Semi-Floating Axle, Overhung Hypoid Drive Pinion And Ring Gear
Limited slip differential (type)		Disc Clutch
Drive pinion	Type	Hypoid Gear
	Offset	44.0 (1.75)
No. of differential pinions		2
Pinion/differential	Adjustment (shim, etc.)	Shim
	Bearing adjustment	Collapsible Sleeve
Driving wheel bearing (type)		Direct Or Single Row Cylindrical
Lubricant	Capacity [L (pt.)]	2.0 (4.2)
	Type recommended	GL-5 Gear Lubricant

○ Propeller Shaft - Rear Wheel Drive

Manufacturer Type (straight tube, tube-in-tube, internal-external damper, etc.)		Straight Tube	
Outer diam. x length* x wall thickness	Manual 3-speed transmission	Not Available	
	Manual 4-speed transmission	"	
	Manual 5-speed transmission	"	
	Overdrive	"	
	Automatic transmission	76.20 x 1455 x 1.65 mm (3.00 x 57.3 x .065 in.)	
Inter-mediate bearing	Type (plain, anti-friction)	None	
	Lub. (fitting, prepack)	None	
Slip yoke	Type	Splined	
	Number of teeth	27	
	Spline o.d.	29.858 (1.175)	
Universal joints	Make and mfg. no.	Front	Saginaw Division, 44
		Rear	Saginaw Division, 44
	Number used	2	
	Type (ball and trunnion, cross)	Cross	
	Rr. attach(u-bolt, clamp, etc)	Strap & Bolt	
Bearing	Type (plain, anti-friction)	Anti-Friction	
	Lubrication (fitting, prepack)	Prepacked	
Drive taken through (torque tube, arms or springs)		Control Arm	
Torque taken through (torque tube, arms or springs)		Control Arm	

* Centerline to centerline of universal joints, or to centerline of attachment.



MVMA Specifications

Vehicle Line CAPRICE/CAPRICE POLICE/CAPRICE FLEET
 Model Year 1990 Issued 6-89 Revised(*)

METRIC (U.S. Customary)
 Body Type And/Or
 Engine Displacement

SEDANS	STATION WAGON
--------	---------------

Suspension - General Including Electronic Controls

Car leveling	Std./opt./n.a.	Not Available	Optional (Rear Only)	
	Manual/automatic control	"	Manual	
	Type (air/hydraulic)	"	Air	
	Primary/assist spring	"		
	Rear only/4 wheel leveling	"		
	Single/dual rate spring	"		
	Single/dual ride heights	"		
Shock absorber damping controls	Provision for jacking	Not Applicable		
	Std./opt./n.a.	"		
	Manual/automatic control	"		
	Number of damping rates	"		
	Type of actuation (manual/electric motor/air, etc.)	"		
	s e n s o r s	Lateral acceleration	"	
		Deceleration	"	
Acceleration		"		
Road surface		"		
Shock absorber (front & rear)	Type	Direct Double Acting Hydraulic		
	Make	Delco		
	Piston diameter	25 mm (1.0 in.) 32 mm (1.26 in.)		
	Rod diameter	12.4 mm (.49 in.) (Base & SEO)/(F41) 12.4 mm (.49 in.)		

Suspension - Front

Type and description		Independent - SLA	
Travel*	Full jounce	90.3mm (3.56 in.)	
	Full rebound	107.7mm (4.24 in.)	
Spring	Type (coil, leaf, other) & matl	Coil, Steel	
	Insulators (type & matl)	Ring Type Natural Rubber	
	Size (coil design height & l.d.)	241.3 x 102.9 x 3347 x 15.8 mm (9.5 x 4.05 x 131.7 x 0.622 in.)	241.3 x 102.9 x 2762.2 x 16.1 mm (9.5 x 4.05 x 108.7 x 0.634 in.)
	Spring rate [N/mm (lb./in.)]	SEO only-47.0 (268.0); V8-52.5 (300.0)	V8 & SEO 77.0 (440)
Stabilizer	Rate @ wheel [N/mm (lb./in.)]	SEO only-14.4 (82.3); V8-15.8 (90.3)	V8 & SEO 22.5 (129)
	Type (link, linkless, frmless)	Link	
Material & bar diameter		Base & F40 Tubular Steel - 28.0 mm (1.1 in.); SEO-Solid Steel-28.0mm (1.1 in.) (1.14 in.); Wagon - Solid Steel-28.0 mm (1.1 in.); F41 Solid Steel 30.0 mm (1.18 in.)	

Suspension - Rear

Type and description		Salisbury 4-Link	
Travel*	Full jounce	123.0mm (4.8 in.)	101mm (3.98 in.)
	Full rebound	114.0mm (4.5 in.)	112mm (4.41 in.)
Spring	Type (coil, leaf, other) & matl	Coil, Steel	
	Size (length x width, coil design height & l.d.)	254 x 139.7 x 2961.3 x 13.44 mm (10.0 x 5.5 x 116.6 x 0.529 in.)	254 x 139.7 x 2585.7 x 15.5 mm (10.0 x 5.5 x 101.8 x 0.609 in.)
	Spring rate [N/mm (lb./in.)]	17.5 (100.0), W/F40 & 41-27.1 (155.0)	36.8 (210.0)
	Rate @ wheel [N/mm (lb./in.)]	19.4 (110.0), W/F40 & 41-27.2 (155.0)	35.3 (202.0)
	Insulators (type & material)	Ring Type Butyl Rubber	
If leaf	No. of leaves	Not Available	
	Shackle (comp or tens)	"	
Stabilizer	Type (link, linkless, frmless)	Linkless (a) 0.9	None
	Material & bar diameter	Steel - 24.0 mm (0.94 in.) SEO - 25.0 mm (0.98 in.)	
Track bar (type)		None	

* Define load condition:

(a) Used With RPO F42 Sport Suspension



MVMA Specifications

Vehicle Line CAPRICE/CAPRICE POLICE/CAPRICE FLEET
 Model Year 1990 Issued 6-89 Revised(*)

METRIC (U.S. Customary)

Body Type And/Or
 Engine Displacement
 Brakes - Service

SEDANS	STATION WAGON
--------	---------------

Description		Single Callper Disc Front, Duo-Servo Drum Rear		
Manufacturer and brake type (std., opt., n.a.)	Front (disc or drum)	Disc		
	Rear (disc or drum)	Drum		
Valing type(prop, delay, metering, other)		Metering & Proportioning	Metering	
Power brake (std., opt., n.a.)		Standard		
Booster type(rmt, intgr, vac., hyd., etc.)		Vacuum		
Vacuum	Source (inline, pump, etc.)	Inline (Intake Manifold)		
	Reservoir (volume cu. in.)	---		
	Pump-type	---		
Traction Control	Operational speed range	Not Applicable		
	Type engine intervention	"		
Anti-lock device	Front/rear (std., opt., n.a.)	"		
	Manufacturer	"		
	Type (electronic, mech.)	"		
	Number sensors or circuits	"		
	No. anti-lock hyd. circuits	"		
	Integral or add-on system	"		
	Yaw control (yes, no)	"		
Hydraulic power source	"			
Effective area (sq. cm. (sq. in.))*		648 (100.5)	746.5 (115.7)	
Gross Lng area (sq cm (sq in))**(F/R)		717 (111.1)	846.1 (131.1)	
Swept area (sq cm (sq in))*** (F/R)		2127 (329.8)	255.8 (396.8)	
Rotor	Outer working diameter	F/R 279.1 (11.0)/--	301.2 (11.86)/--	
	Inner working diameter	F/R 177.8 (7.0)/--	187.4 (7.77)/--	
	Thickness	F/R 26.2 mm (1.03 in.)/--		
	Matl & type (vented/std)	F/R Cast Iron, Vented /--		
Drum	Diameter & width	F/R --/241.3 (9.5)	--/279.4 mm (11.0 in.)	
	Type and material	F/R --/ Cast Iron Finned		
Wheel cylinder bore		F 74.7mm (2.94 in.); R 22.22mm (.875 in.)	74.7mm(2.94in.)/23.8mm(.84in.)	
Master cylinder	Bore/stroke	F/R F 28.6mm (1.13 in.); R 39.6mm (1.56 in.)		
Pedal ratio		3.5:1		
Line pressure at 445 N (100 lb.) pedal load (kPa (psi))		Not Available		
Lining clearance		F/R	Self-Adjusting / Self-Adjusting	
Brake lining	Front wheel	Bonded or riveted	Riveted; 8	
		Rivet size	5.33 x 9.12 mm (.21 x .36 in.)	5.33 x 9.83 mm (.21 x .38 in.)
		Manufacturer	Bendix	
		Lining code *****	333-EE (Bendix 716 1A)	
		Material	Semi-Metallic 7161A	
		**** Pri. or out-brd	137 x 48.8 x 11.81 mm (5.40 x 1.92 x 0.465 in.)	
	Size	Sec. or in-brd	137 x 48.8 x 11.81 mm (5.40 x 1.92 x 0.465 in.)	
	Rear wheel	Shoe thoknss.(no lng)	Inboard 15.75 (.620); Outboard 14.0 (.550)	
		Bonded or riveted	Riveted; 10-Primary, 12-Secondary	
		Manufacturer	Inland	
		Lining code *****	PRIM/SEC = 224FF/235FE	
		Material	PRIM/SEC = Organic 4035/4050	
**** Pri. or out-brd		192.5 x 50.8 x 4.98 (7.58 x 2.0 x .196)	225 x 50.8 x 5.6 (8.86 x 2.0 x 0.22)	
Size	Sec. or in-brd	249.7 x 50.8 x 6.73 (9.83 x 2.0 x .265)	291.0 x 50.8 x 6.6(11.5 x 2.0 x 0.26)	
Shoe thcknss (no lng)		Prim-7.8 (.301); Sec-9.4 (.370)	Prim 8.3 (.330); Sec - 9.1 (.370)	

* Excludes rivet holes, grooves, chamfers, etc. **Includes rivet holes, grooves, chamfers, etc.
 *** Total swept area for four brakes. (Drum brake: Widest lining contact width for each brake x its contact circum.)
 (Disc brake: Square of Outer Working Dia. - Square of inner Working Dia. X Pi/2 for each brake.)
 **** Size for drum brakes includes length x width x thickness.
 ***** Manufacturer I.D., catalog for formulation designation and coefficient of friction classification.



MVMA Specifications

Vehicle Line CAPRICE/CAPRICE FLEET VEHICLE
 Model Year 1990 Issued 6-89 Revised(*)

METRIC (U.S. Customary)

Body Type And/Or
 Engine Displacement

SEDANS

STATION WAGON

Tires And Wheels (Standard)

Tires	Size (load range, ply)	P205/75R15 (B/W*)		P225/75R15 (W/W*)		
	Type (bias, radial, etc.)	Steel Belted Radial				
	Inflation pressure (cold) for recommended max. vehicle load	Front [kPa(psi)]	240 (35)	205 (30)		
		Rear [kPa(psi)]	240 (35)	240 (35)		
	Rev/mile-at 70 km/h(45mph)	478		458		
Wheels	Type & material	Short Spoke Disc, Steel				
	Rim (size & flange type)	15 x 6		15 x 7		
	Wheel offset	5.08-8.13 (0.20-0.32)		7.5 mm (0.30 in.)		
	Attachment	Type(bolt,stud)	Stud			
		Circle diameter	120.6 mm (4.75 in.)		127.0 mm (5.00 in.)	
Number & size	5 - 7/16-20 UNF - 2B Hex Nuts		5 - 1/2-20 UNF - 2B Hex Nuts			
Spare	Tire and wheel	16 x 4 Compact Spare, T125/80D16 (Without Positraction) 16 x 4 Compact Spare, T145/80D16 (W/Positraction And Wagons)				
	Storage position & location (describe)	Sedans - Horizontal Front Center Of Trunk Compartment. Station Wagon - Vertical Right Rear Quarter Panel.				

* Tires Are "All Season" Mud And Snow, 4th Generation, GM TPC Tires

Tires And Wheels (Optional)

Tire size (load range, ply)	P205/75R15 (W/W*, +)	Not Applicable
Type (bias, radial, steel, nylon, etc.)	Steel Belted Radial	
Wheel (type & material)	Short Spoke Disc, Steel	
Rim (size, flange type and offset)	15 x 6; 5.08 - 8.13 mm (0.20-0.32 in.)	
Tire size (load range, ply)	P225/70R15 (W/W)*+ (a)	
Type (bias, radial, steel, nylon, etc.)	Steel Belted Radial	
Wheel (type & material)	Short Spoke Disc Steel	
Rim (size, flange type and offset)	15 x 7; 5.08 - 8.13 mm (0.20 - 0.32 in.)	
Tire size (load range, ply)		
Type (bias, radial, steel, nylon, etc.)		
Wheel (type & material)		
Rim (size, flange type and offset)		
Tire size (load range, ply)		
Type (bias, radial, steel, nylon, etc.)		
Wheel (type & material)		
Rim (size, flange type and offset)		
Spare tire and wheel size		
(if configuration is different than road tire or wheel, describe optional spare tire and/or wheel location & storage position)		
	(a) - Requires Performance Handling Package, RPO F41.	

Brakes - Parking

Type of control	Foot Pedal Application; "T" Handle Release	
Location of control	Under Instrument Panel; Left Of Steering Column	
Operates on	Rear Service Brakes	
If separate from service brakes	Type(internal or external)	--
	Drum diameter	--
	Lining size (length x width x thickness)	--

MVMA Specifications

Vehicle Line CAPRICE POLICE VEHICLE (SEO 9C1)
 Model Year 1990 Issued 6-89 Revised(*)

METRIC (U.S. Customary)

Body Type And/Or Engine Displacement SEDANS - SEO

Tires And Wheels (Standard)

Tires	Size (load range, ply)		P205/75R15 (B/W*) (b)
	Type (bias, radial, etc.)		Steel Belted Radial
	Inflation pressure (cold) for recommended max. vehicle load	Front [kPa(psi)]	240 (35)
		Rear [kPa(psi)]	240 (35)
	Rev/mile-at 70 km/h(45mph)		478
Wheels	Type & material		Short Spoke Disc, Steel
	Rim (size & flange type)		15 x 6
	Wheel offset		.50
	Attachment	Type(bolt,stud)	Stud
		Circle diameter	120.6 mm (4.75 in.)
Number & size		5 - 7/16-20 UNF - 2B Hex Nuts	
Spare	Tire and wheel		16 x 4 Compact Spare, T125/80D16 (Without Positraction) 16 x 4 Compact Spare, T145/80D16 (W/Positraction And Wagons)
	Storage position & location (describe)		Sedans - Horizontal Front Center Of Trunk Compartment. Station Wagon - Vertical Right Rear Quarter Panel.

* Tires Are "All Season" Mud and Snow, 4th Generation, GM TPC Tires

Tires And Wheels (Optional)

Requires SAS - Approval

Tire size (load range, ply)		P205/75R15 (W/W*, +) (b)	
Type (bias, radial, steel, nylon, etc.)		Steel Belted Radial	
Wheel (type & material)		Short Spoke Disc, Steel	
Rim (size, flange type and offset)		15 x 6; (.50)	
Tire size (load range, ply)		P225/70R15 (W/W)*+ (a) "All Season".	P225/70HR15 (B/W) Highway
Type (bias, radial, steel, nylon, etc.)		Steel Belted Radial	P225/70HR15 (B/W) Highway
Wheel (type & material)		Short Spoke Disc Steel	P225/70HR15 (B/W) Highway
Rim (size, flange type and offset)		15 x 7; (.30)	P225/70HR15 (B/W) Highway
Tire size (load range, ply)		P225/70HR15 (B/W) "All Season"	P225/70HR15 (W/W) Highway
Type (bias, radial, steel, nylon, etc.)		Steel Belted Radial	P225/70HR15 (W/W) Highway
Wheel (type & material)		Short Spoke Disc, Steel	P225/70HR15 (W/W) Highway
Rim (size, flange type and offset)		15 x 7; (.30)	P225/70HR15 (W/W) Highway
Tire size (load range, ply)			
Type (bias, radial, steel, nylon, etc.)			
Wheel (type & material)			
Rim (size, flange type and offset)			
Spare tire and wheel size			
(If configuration is different than road tire or wheel, describe optional spare tire and/or wheel location & storage position)		(a) - Requires Performance Handling Package, RPO F41. (b) - Not Speed Rated	

Brakes - Parking

Type of control		Foot Pedal Application; "T" Handle Release
Location of control		Under Instrument Panel; Left Of Steering Column
Operates on		Rear Service Brakes
If separate from service brakes	Type(internal or external)	--
	Drum diameter	--
	Lining size (length x width x thickness)	---



MVMA Specifications

Vehicle Line CAPRICE/CAPRICE POLICE/CAPRICE FLEET
 Model Year 1990 Issued 6-89 Revised(*)

METRIC (U.S. Customary)

Body Type And/Or
 Engine Displacement

SEDANS	STATION WAGON
--------	---------------

Steering

Manual (std., opt., n.a.)		Not Available			
Power (std., opt., n.a.)		Standard And Includes Quick Prime Feature			
Adjustable steering wheel/column (tilt, telescope, other)	Type	Tilt-Universal Jointed Steering Shaft At Base Of Steering Wheel 6-Position			
	Manufacturer	Saginaw Division			
	(std., opt., n.a.)	Optional			
Wheel diameter ** (W9) SAE J1100	Manual	Not Available			
	Power	387 mm (15.25 in.)			
Turning diameter m (ft.)	Out-side front	Wall to wall (l. & r.)	13.8 (44.6) 13.8 (45.3)		
		Curb to curb (l. & r.)	11.8 (38.7) 12.1 (39.7)		
	In-side rear	Wall to wall (l. & r.)	Not Available		
		Curb to curb (l. & r.)	6.43 (21.1)/7.07 (23.2)		
Scrub Radius *		Not Available			
Manual	Gear	Type	Not Applicable		
		Manufacturer	"		
		Ratios	Gear	"	
			Overall	"	
	No. wheel turns(stop to stop)		"		
Power	Type (hydraulic, elec., etc.)		Integral Gear With Power Piston & Vane Type Pump; Cooler Pipe Available		
	Manufacturer		Saginaw Division On SEO Only		
	Gear	Type	Semi-Reversible Recirculation Ball Nut		
		Ratios	Gear	14:1 12.7:1 (a) 13/16:1	
			Overall	18.5 15.0:1 (a) 18.8:1 On Center	
	Pump (drive)		Serpentine Belt V-Belt		
No. wheel turns(stop to stop)		3.16 3.3			
Linkage	Type		Parallelogram		
	Location (front or rear of wheels, other)		Front		
	Tie Rods (one or two)		2		
Steering axis	Inclination at camber (deg.)		9.785 @ 1		
	Bear-ings (type)	Upper	Ball Stud With Metallic Surfaces		
		Lower	Ball Stud With Metallic Surfaces		
		Thrust	None		
Steering spindle/knuckle & joint type		"			
Wheel spindle/hub	Dia-meter	Inner bearing	31.7 mm (1.25 in.)		
		Outer bearing	18.0 mm (0.75 in.)		
	Thread (size)		3/4-20		
	Bearing (type)		Tapered Roller		

* The horizontal distance in the front elevation between wheel centerline and kingpin (ball joint) axis at ground.
 ** See Page 22.

(a) F41 Sport Suspension Option



MVMA Specifications

Vehicle Line CAPRICE/CAPRICE POLICE/CAPRICE FLEET
 Model Year 1990 Issued 6-89 Revised(*)

METRIC (U.S. Customary)

Body Type And/Or
 Engine Displacement

SEDANS

STATION WAGON

Wheel Alignment

Front wheel at curb mass (wt.)	Service checking	Caster (deg.)	+2 to +4	2.8 (+/-) 1.0
		Camber (deg.)	0 to +1.6	0 (+/-) 0.8
		Toe-in (outside track-mm (in.))	+3 (+/-) 0.5	2.8 (+/-) 1.0
	Service reset*	Caster (deg.)	+0.8 (+/-) 0.8	0 (+/-) 0.8
		Camber (deg.)	+0.05 (+/-) .05	0.10 (+/-) 0.10
		Toe-in (deg.)	+1 to +5	2.8 (+/-) 1.0
	Periodic M.V. inspection	Caster (deg.)	-0.7 to +2.3	0 (+/-) 0.8
		Camber (deg.)	-0.15 to +0.55 (-3/16" to +9/16")	0.10 (+/-) 0.20
		Toe-in (deg.)	-0.15 to +0.55 (-3/16" to +9/16")	
Rear wheel at curb mass (wt.)	Service checking	Camber (deg.)	Not Applicable	
		Toe-in (outside track-mm (in.))	"	
	Service reset*	Camber (deg.)	"	
		Toe-in (deg.)	"	
	Periodic M.V. inspection	Camber (deg.)	"	
		Toe-in (deg.)	"	

* Indicates pre-set, adjustable, trend set or other.

Electrical - Instruments and Equipment

Speedometer	Type (analog, digital, std., opt.)	Rectangular Dial With Pointer (A)
	Trip odometer (std., opt., n.a.)	Optional (A)
EGR maintenance indicator		Not Available
Charge indicator	Type	Tell-Tale Warning Light (A)
	Warning device (light, audible)	Not Available
Temperature indicator	Type	Tell-Tale Warning Light (A)
	Warning device	Not Available
Oil pressure indicator	Type	Tell-Tale Warning Light
	Warning device	Not Available
Fuel indicator	Type	Electric Gauge, Pointer Gauge
	Warning device	Not Available
Windshield wiper	Type (standard)	Electric, Two-Speed
	Type (optional)	Intermittent Control Type
	Blade length	457.2 mm (18.0 in.)
	Swept area (sq cm (sq in))	6107 (946.8)
Windshield washer	Type (standard)	Push Button, Fluidic Nozzle
	Type (optional)	Not Available
	Fluid level indicator	"
Rear window wiper, wiper/washer (std., opt., n.a.)		Not Available
Horn	Type	Vibrator
	Number used	2
Other		Restraint System Warning Light And Buzzer. Parking Brake And Brake Failure Warning Light. "Tailgate Ajar" Lamp For Station Wagon. "Headlamp-On Chime For 1BN00 Models.

(A) Optional Gauge Package Includes Circular Speedometer, Trip Odometer, Coolant Temperature Gauge, And Voltmeter.

(B) Buzzer For 1BL00, Chime For 1BN00.



MVMA Specifications

Vehicle Line CAPRICE / CAPRICE POLICE VEHICLE (SEO 9C1)
 Model Year 1990 Issued 6-89 Revised(*) 8-89

METRIC (U.S. Customary)

Engine Description
 Engine Code

5.0 LITER V8 (305 CID)
 THROTTLE BODY INJECTION RPO L03

Electrical - Supply System

Battery	Manufacturer	Delco Remy
	Model, std., (opt.)	Standard
	Voltage	12
	Amps at 0 deg F cold crnk	525
	Minutes-reserve capacity	90
	Amps/hrs. ~ 20 hr. rate	--
	Location	Engine Compartment
Alternator	Manufacturer	Delco Remy
	Rating (idle/max. rpm)	100 Amps
	Ratio (alt. crank/rev.)	3.0:1
	Output at idle (rpm, park)	
	Optional (type & rating)	None
Regulator	Type	Micro Circuit Units, Integral With Alternator

Electrical - Starting System

Motor	Manufacturer	Delco Remy
	Current drain 20 deg F	420 Amps
	Power rating (kw (hp))	2.3 (3.1)
Motor drive	Engagement type	Positive Shift Solenoid
	Pinion engages from (front, rear)	Rear

Electrical - Ignition System

Type	Electronic (std, opt, n.a.)	---	
	Other (specify)	High Energy Ignition, (H.E.I.)	
Coil	Manufacturer	Delco Remy	
	Model	Separate	
	Current	Engine stopped-A	0 Amp
		Engine idling - A	1
Spark plug	Manufacturer	AC	
	Model	R45TS	
	Thread (mm)	14 x 1.25	
	Tightening torque [Newton meters (lb. ft.)]	9-20 (7-15)	
	Gap	0.89 (0.035)	
	Number per cylinder	1	
Distributor	Manufacturer	Delco Remy	
	Model		

Electrical - Suppression

Locations & type	Internal Alternator Capacitor, Non-Metallic High-Tension Ignition Cables, Resistor Spark Plugs, Ignition Coil By-Pass Capacitor, Internal AC Blower Motor By-Pass Capacitor & A/C Compression Diode, With Radio Provisions; Hood Grounding Clip, Engine To Dash Panel Ground Strap, Fuse Block Capacitor And On "Heater Only" Blower Motors And Coax Capacitor.
------------------	---



MVMA Specifications

Vehicle Line CAPRICE POLICE VEHICLE (SEO 9C1)
 Model Year 1990 Issued 6-89 Revised(*) 9-89

METRIC (U.S. Customary)

Engine Description	6.7 LITER V8 (350 CID)
Engine Code	THROTTLE BODY INJECTION RPO L05

Electrical - Supply System

Battery	Manufacturer	Delco Remy
	Model, std., (opt.)	Standard
	Voltage	12
	Amps at 0 deg F cold crnk	730
	Minutes-reserve capacity	90
	Amps/hrs. - 20 hr. rate	---
	Location	Engine Compartment
Alternator	Manufacturer	Delco Remy
	Rating (idle/max. rpm)	100 Amps
	Ratio (alt. crank/rev.)	3.0:1
	Output at (idle rpm, park)	
Optional (type & rating)	None	
Regulator	Type	Micro Circuit Units, Integral With Alternator

Electrical - Starting System

Motor	Manufacturer	Delco Remy
	Current drain 20 deg F	420 Amps
	Power rating [kw (hp)]	2.3 (3.1)
Motor drive	Engagement type	Positive Shift Solenoid
	Pinion engages from (front, rear)	Rear

Electrical - Ignition System

Type	Electronic (std, opt, n.a.)	---	
	Other (specify)	High Energy Ignition, (H.E.I.)	
Coil	Manufacturer	Delco Remy	
	Model	Separate	
	Current	Engine stopped - A	0 Amp
		Engine idling - A	1
Spark plug	Manufacturer	AC	
	Model	R45TS	
	Thread (mm)	14 x 1.25	
	Tightening torque (Newton meters (lb. ft.))	9-20 (7-15)	
	Gap	0.89 (0.035)	
	Number per cylinder	1	
Distributor	Manufacturer	Delco Remy	
	Model		

Electrical - Suppression

Locations & type	Internal Alternator Capacitor, Non-Metallic High-Tension Ignition Cables, Resistor Spark Plugs, Ignition Coil By-Pass Capacitor, Internal AC Blower Motor By-Pass Capacitor & A/C Compression Diode, With Radio Provisions; Hood Grounding Clip, Engine To Dash Panel Ground Strap, Fuse Block Capacitor And On "Heater Only" Blower Motors And Coax Capacitor.
------------------	---



MVMA Specifications

Vehicle Line CAPRICE FLEET VEHICLE
 Model Year 1990 issued 6-89 Revised(*) 9-89

METRIC (U.S. Customary)

Engine Description
 Engine Code

4.3 LITER V6 (262 CID)
 THROTTLE BODY INJECTION RPO LB4

Electrical - Supply System

Battery	Manufacturer	Delco Remy
	Model, std., (opt.)	Standard
	Voltage	12
	Amps at 0 deg F cold crnk	570
	Minutes-reserve capacity	90
	Amps/hrs. - 20 hr. rate	--
	Location	Engine Compartment
Alternator	Manufacturer	Delco Remy
	Rating (idle/max. rpm)	100 Amps
	Ratio (alt. crank/rev.)	3.0:1
	Output at idle (rpm, park)	
	Optional (type & rating)	None
Regulator	Type	Micro Circuit Units, Integral With Alternator

Electrical - Starting System

Motor	Manufacturer	Delco Remy
	Current drain 20 deg F	420 Amps
	Power rating [kw (hp)]	2.3 (3.1)
Motor drive	Engagement type	Positive Shift Solenoid
	Pinion engages from (front, rear)	Rear

Electrical - Ignition System

Type	Electronic (std, opt, n.a.)	--
	Other (specify)	High Energy Ignition, (H.E.I.)
Coil	Manufacturer	Delco Remy
	Model	Separate
	Current	Engine stopped-A 0 Amp Engine idling - A 1
Spark plug	Manufacturer	AC
	Model	R45TS
	Thread (mm)	14 x 1.25
	Tightening torque [Newton meters (lb. ft.)]	9-20 (7-15)
	Gap	0.89 (0.035)
	Number per cylinder	1
Distributor	Manufacturer	Delco Remy
	Model	

Electrical - Suppression

Locations & type	Internal Alternator Capacitor, Non-Metallic High-Tension Ignition Cables, Resistor Spark Plugs, Ignition Coil By-Pass Capacitor, Internal AC Blower Motor By-Pass Capacitor & A/C Compression Diode, With Radio Provisions; Hood Grounding Clip, Engine To Dash Panel Ground Strap, Fuse Block Capacitor And On "Heater Only" Blower Motors And Coax Capacitor.
------------------	---



MVMA Specifications

Vehicle Line CAPRICE
 Model Year 1990 Issued 6-89 Revised(*) 9-89

METRIC (U.S. Customary)

Engine Description **5.0 LITER V8 (307)**
 Engine Code **4-BBL CARBURETOR RPO LV2**

Electrical - Supply System

Battery	Manufacturer	Delco Remy
	Model, std., (opt.)	Standard
	Voltage	12
	Amps at 0 deg F cold crnk	525 Base; 570 H.D.
	Minutes-reserve capacity	90 Base; 90 H.D.
	Amps/hrs. - 20 hr. rate	--
	Location	Engine Compartment
Alternator	Manufacturer	Delco Remy
	Rating (idle/max. rpm)	85 Amps
	Ratio (alt. crank/rev.)	3.53:1
	Output at idle (rpm, park)	
	Optional (type & rating)	None
Regulator	Type	Micro Circuit Units, Integral With Alternator

Electrical - Starting System

Motor	Manufacturer	Delco Remy
	Current drain 20 deg F	325 Amps
	Power rating (kw (hp))	1.4 (1.9)
Motor drive	Engagement type	Positive Shift Solenoid
	Pinion engages from (front, rear)	Front

Electrical - Ignition System

Type	Electronic (std, opt, n.a.)	Standard	
	Other (specify)	High Energy Ignition, (H.E.I.)	
Coil	Manufacturer	Delco Remy	
	Model	Separate	
	Current	Engine stopped-A	0 Amp
		Engine idling - A	1
Spark plug	Manufacturer	AC Division	
	Model	FR3LS6	
	Thread (mm)	14mm (0.551 in.)	
	Tightening torque [Newton meters (lb. ft.)]	40 (30)	
	Gap	1.52mm (.060 in.)	
	Number per cylinder	1	
Distributor	Manufacturer	Delco Remy	
	Model		

Electrical - Suppression

Locations & type	Internal Alternator Capacitor, Non-Metallic High-Tension Ignition Cables, Resistor Spark Plugs, Ignition Coil By-Pass Capacitor, Internal AC Blower Motor By-Pass Capacitor & A/C Compression Diode, With Radio Provisions; Hood Grounding Clip, Engine To Dash Panel Ground Strap, Fuse Block Capacitor And On "Heater Only" Blower Motors And Coax Capacitor.
------------------	---



MVMA Specifications

Vehicle Line CAPRICE/CAPRICE POLICE/CAPRICE FLEET
 Model Year 1990 Issued 6-89 Revised(*)

METRIC (U.S. Customary)

Body Type

ALL

Body

Structure	All-Welded Heavy-Gage Steel Body. Full Perimeter Frame.
Bumper System Front - Rear	Steel Bumper With Reinforcing Beam. Dual Energy Absorbers. Bumper Rub Strips Standard On Caprice Classic Sedan, Wagon, And Brougham.
Anti-Corrosion Treatment	Zinc-Rich Precoated Steel Is Used In Many Critical Areas, Splash Areas Treated With Zinc-Rich Primers And Special Waxes. Hot-Melt Materials Used For Sealing. Bodies Are Submersed In Zinc Phosphate Rustproofing Process Before Final Epo-Coating Dip.

Body - Miscellaneous Information

Type of finish (lacquer, enamel, other)	Lacquer	
Hood	Material & mass	Double Panel Steel
	Hinge location (front, rear)	Rear
	Type (counterbalance, prop)	4-Link Type With Spiral Spring
	Release control (int., ext.)	Internal
Trunk lid	Material & mass	Double Panel Steel
	Type (counterbalance, other)	Counterbalance
	Internal release control (elec., mech., n.a.)	Electric - Optional
Hatch-back lid	Material & mass	Not Applicable
	Type (counterbalance, other)	"
	Internal release control (elec., mech., n.a.)	"
Tailgate	Material & mass	Galvanized Steel - 19.85 kg. (43.8 lbs.)
	Type (drop, lift, door)	"3-Way" With Power Window Standard
	Internal release control (elec., mech., n.a.)	Not Available
Vent window control (crank, friction, pivot, power)	Front	None
	Rear	None
Window regulator type (cable, tape, flex drive, etc.)	Front	Tape Drive - Manual/Power Optional
	Rear	Tape Drive - Manual/Power Optional
Seat cushion type (e.g., 80/40, bucket, bench wire, foam, etc.)	Front	Bench*, Formed Full Foam Pad
	Rear	Bench, Formed Full Foam Pad
	3rd seat	Bench, Formed Full Foam Pad. Rear Facing.
Seat back type (e.g., 80/40, bucket, bench, wire, foam, etc.)	Front	Bench*, Formed Full Foam Pad
	Rear	Bench, Formed Full Foam Pad
	3rd seat	Bench, Formed Full Foam Pad. Rear Facing
		* - 50/50 Seat Optional For Caprice, Caprice Classic Models. 55/45 Seat Standard For Caprice Classic Brougham.

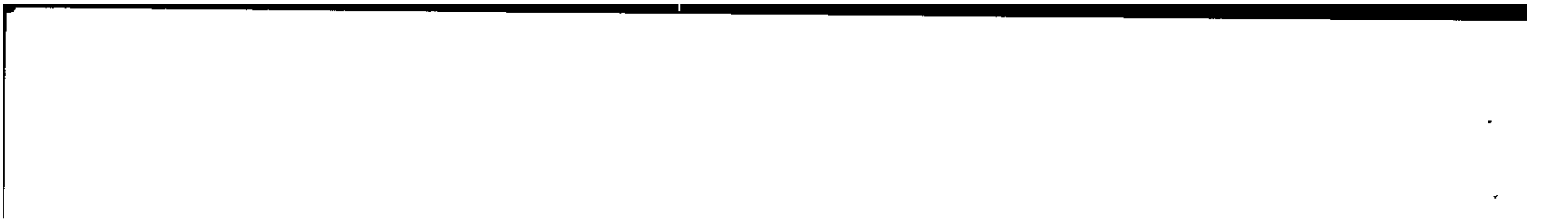

MVMA Specifications

Vehicle Line CAPRICE/CAPRICE POLICE/CAPRICE FLEET
 Model Year 1990 Issued 6-89 Revised(*) _____

METRIC (U.S. Customary)

Body Type

SEDANS

STATION WAGON

Restraint System

Seating Position			Left	Center	Right
Active	Type & description (lap & shoulder belt, lap belt, etc.)	First seat		Lap Only	Same As Left
		Second seat	Lap & Shoulder Belt Double Retractors No Comfort Mechanism	Lap Only	Same As Left Rear
	Standard/ optional	Third seat	Lap Only		Lap Only
Passive	Type & description (air bag, motorized-2-point belt, fixed belt, knee bolster, manual-lap belt)	First seat	3-Point Door Mounted Belt System		
		Second seat			
	Standard/ optional	Third seat			

Glass

	SAE Ref No		
Windshield glass exposed surface area [sq. cm. (sq. in.)]	S1	8619 (1335.9)	
Side glass exposed surface area [sq. cm. (sq. in.)] - total 2- sides	S2	12006 (1860.9)	19950 (3092.2)
Backlight glass exposed surface area [sq. cm. (sq. in.)]	S3	5278 (818.1)	4661 (722.5)
Total glass exposed surface area [sq. cm. (sq. in.)]	S4	25903 (4015.0)	33230 (5150.6)
Windshield glass (type)		Curved - Laminated Plate	
Side glass (type)		Curved - Tempered Plate	
Backlight glass (type)		Curved - Tempered Plate	

Headlamps

Description - sealed beam, halogen, replaceable bulb, etc.	Halogen, Replaceable Bulb (Composite)
Shape	Rectangular
Lo-beam type (2A1, 2B1, 2C1, etc.)	HB4 Bulb/Glass Lens Face on Housing
Quantity	2
Hi-beam type (1A1, 2A1, 1C1, 2C1, etc.)	HB3 Bulb/Glass Lens Face on Housing
Quantity	2

Frame

Type and description (separate frame, unitized frame, partially-unitized frame)	Perimeter Type, Two Crossmembers
---	----------------------------------

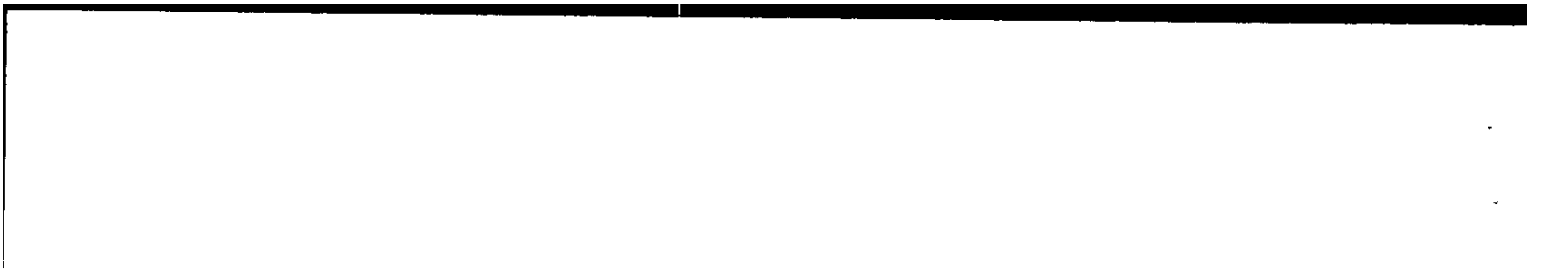

MVMA Specifications

Vehicle Line CAPRICE/CAPRICE POLICE/CAPRICE FLEET
 Model Year 1990 Issued 8-89 Revised(*) _____

METRIC (U.S. Customary)

Body Type

SEDANS

STATION WAGON

Convenience Equipment (standard, optional, n.a.)

Air conditioning (manual, auto, temp control)		Standard - Four Season Manual Control
Clock (digital, analog)		Digital Clock In Radio Standard
Compass / thermometer		Compass - Dealer Installed
Console (floor, overhead)		Not Available
Defroster, elec. backlight		Optional
Electronic	Diagnostic monitor (integrated, individual)	Not Available
	Instrument cluster (list instruments)	.
	Keyless entry	.
	Tripminder (avg. spd. fuel)	.
	Voice alert (list items)	.
	Other	Radio Tuning
Fuel door lock (remote, key, electric)		Not Available
Lamps	Auto head on/off delay, dimming	Optional (Twilight Sentinel) NA 1BL69
	Cornering	Optional - Not Available 1BL69
	Courtesy (map, reading)	Optional (2) In Dome-Lamp
	Door lock, ignition	Not Available
	Engine compartment	Optional
	Fog	Not Available
	Glove compartment	Standard
	Trunk	Standard Rear Dome Standard
	Illuminated entry system (list lamps, activation)	Standard - IBU Door Mounted Entry Lamp
	Other	
Mirrors	Ash Tray (Front)	Standard
	Day / night (auto, man.)	Standard - Manual
	L.H. (remote, pwr., heated)	Standard - Remote
	R.H. (convex, rmt, pwr, htd)	Convex, Manual Standard, Remote - Optional
	Visor vanity (RH/LH illum.)	Optional - RH, Not Available 1BL69
Navigation system (describe)		Not Applicable
Prtg. brake-auto release (warn. light)		Standard - Hand Release



MVMA Specifications

Vehicle Line CAPRICE/CAPRICE POLICE/CAPRICE FLEET
 Model Year 1990 Issued 6-89 Revised(*)

METRIC (U.S. Customary)

Engine Description
 Engine Code

SEDANS	STATION WAGON
--------	---------------

Convenience Equipment (standard, optional, n.a.)

Power equipment	Deck lid (release, pull down)		Striker/Fork Bolt Latch W/Remote Release Optional
	Door locks (manual, auto., describe system)		Striker/Fork Bolt Latch W/Remote Control Rods For Lock/Unlock; Latch/Unlatch - Power Lock/Unlock Optional
	Seats	2 - 4 - 6 way, etc.	AG1 - Adjuster - Seat PWR 6-Way Driver (Opt) W/AV7 Seat
		Reclining (R.H., L.H.)	AG2 - Adjuster - Seat PWR 6-Way Pass (Opt) W/AV7 & AG1
		Memory (R.H., L.H., preset, recline)	AT6 - Adjuster - Seat Back Man Pass Recl (Req) W/AV7
		Lumbar, hip, thigh, support	A79 - Adjuster - Seat Back Man Driver REcl (Req) W/AV7
		Heated (R.H., L.H., other)	AV7 - Seat - Front Split 50/50 (Opt) W/AT6 & A79 A52 - Seat - Front Bench (Base)
	Side windows		Optional (Door Windows Only) NA 1BL69
	Vent windows		Not Available
	Rear windows		Not Available Standard (Tailgate)
Radio systems	Antenna (location, whip, w/shield, power)		Fixed Mast, RH Front Fender, Power Optional, Power N/A 1BL69
	Stan.		AM/FM Stereo, Seek/Scan, ETR With Clock
	Opt.	AM, FM, stereo, tape, compact disc, graphic equalizer, theft deterrent, radio prep package, headphone jacks, etc.	AM/FM Stereo, Seek/Scan, Auto Reverse, Cassette, ETR W/Clock
			AM/FM Stereo, Seek/Scan, Auto Reverse Cassette, ETR, Clock And Graphic Equalizer
Speaker (number, location)		Two In Instrument Panel, Two In Rear Package Shelf, Station Shelf, Station Wagon Rear Pillars, Premium Sound Available For Sedans.	
Roof: open air or fixed (flip-up, sliding, T)			Not Available
Speed control device			Optional
Speed warn. dev. (light, buzzer, etc.)			Not Available
Tachometer (rpm)			Not Available
Telephone system (describe)			Not Available
Theft deterrent system			Standard - Lock Mounted On Steering Column; Locks Steering Wheel, Transmission Shift Lever And Ignition.



MVMA Specifications

Vehicle Line CAPRICE/CAPRICE POLICE/CAPRICE FLEET
 Model Year 1990 Issued 6-89 Revised(*) 9-89

METRIC (U.S. Customary)

Vehicle Dimensions See Key Sheets for definitions

All dimensions to ground are for comparative purposes only. Dimensions are to be shown for all base body models of each vehicle line. SAE Ref. no. refers to the definition published in SAE Recommended Practice J1100 "Motor Vehicle Dimensions," unless otherwise specified.

Body Type

4-DOOR SEDAN 1BL69	4-DOOR SEDAN 1BN69-1BU69	4-DOOR STATION WAGON 1BN35
-----------------------	-----------------------------	-------------------------------

Width

SAE Ref. No.

Tread (front)	W101	1568 (61.7)	1578 (62.2)
Tread (rear)	W102	1542 (60.7)	1628 (64.1)
Vehicle width	W103	1914 (75.4)	2014 (79.3)
Body width at Sg RP (front)	W117	1910 (75.2)	
Vehicle width (front doors open)	W120	3291 (129.6)	
Vehicle width (rear doors open)	W121	3470 (136.6)	3428 (134.9)
Tumble-home (deg.)	W122	24.5	
Outside mirror width	W410		

Length

Wheelbase	L101	2945 (115.9)		
Vehicle length	L103	5388 (212.2)	5405 (212.8)*	5483 (215.7)*
Overhang (front)	L104	1030 (40.8)	1039.5 (40.9)*	1039.5 (40.9)*
Overhang (rear)	L105	1411 (55.8)	1420.5 (55.9)*	1498.5 (58.9)*
Upper structure length	L123	2368 (93.1)		3508 (138.0)
Rear wheel C/L 'X' coordinate	L127	2475 (97.4)		

* Rub strips standard equipment on Caprice Classic sedan and wagon

Height **

Passenger distribution (front/rear)	PD1,2,3		**	
Trunk/cargo load			**	
Vehicle height	H101	1433 (56.4)		1478 (58.2)
Cowl point to ground	H114	1000 (39.4)		1010 (39.8)
Deck point to ground	H138	1023 (40.3)		--
Rocker panel-front to ground	H112	233 (9.2)		242 (9.5)
Rocker panel-rear to ground	H111	242 (9.5)		252 (9.9)
Windshield slope angle (deg.)	H122	53.5		
Backlight slope angle (deg.)	H121	41.5		32.5

Ground Clearance **

Front bumper to ground	H102	306 (12.1)		314 (12.4)
Rear bumper to ground	H104	359 (14.1)	362 (14.3)	301 (11.8)
Bumper to ground (front at curb mass (wt.))	H103	333 (13.1)		332 (13.1)
Bumper to ground (rear at curb mass (wt.))	H105	377 (14.8)	380 (15.0)	311 (12.2)
Angle of approach (deg.)	H106	18.0		18.5
Angle of departure (deg.)	H107	14.0		12.4
Ramp breakover angle (deg.)	H147	14.1		14.5
Axle differential to ground (front/rear)	H153	192 (7.6)		194 (7.6)
Min. running ground clearance	H158	148 (5.8)	187 (7.4)	200 (7.9)
Location of min. run. grd. clear.			Front Suspension	

** All Vehicle Height And Ground Clearance Are Made Using EPA Loaded Vehicle Weight, Loading Conditions.

EPA Loaded Vehicle Weight is the Base Vehicle Weight Plus All Coolant and Fluids Necessary For Operation Plus 100% Of The Fuel Capacity, Plus The Weight Of All Options And Accessories Which Weigh Three Pounds Or More And Which Are Sold On At Least 33% Of The Car Line, Plus Two Occupants.

All linear dimensions are in millimeters (Inches).



MVMA Specifications

Vehicle Line CAPRICE/CAPRICE POLICE/CAPRICE FLEET
 Model Year 1990 Issued 6-89 Revised(*) 9-89

METRIC (U.S. Customary) Vehicle Dimensions

See Key Sheets for Definitions

Body Type

4-DOOR SEDAN 1B169	4-DOOR SEDAN 1B169-1B169	4-DOOR STATION WAGON 1B135
-----------------------	-----------------------------	-------------------------------

Front Compartment

SAE Ref. No.

SgRP front, 'X' coordinate	L31	1078 (42.4)		
Effective head room	H61	1003 (39.5)	997 (39.3)	1005 (39.6)
Max. eff. leg room (accelerator)	L34	1072 (42.2)		
SgRP to heel point	H30	220 (8.7)		
SgRP to heel point	L53	876 (34.5)		
Back angle (deg.)	L40	26.5		
Hip angle (deg.)	L42	97.0		
Knee angle (deg.)	L44	127.0		
Foot angle (deg.)	L48	87.0		
Design H-point front travel	L17	163 (6.4)		
Normal driving & riding seat track trvl.	L23	143 (5.6)		
Shoulder room	W3	1536 (60.5)	1546 (60.9)	
Hip room	W5	1398 (55.0)		1400 (55.1)
*** Upper body opening to ground	H50			
Steering wheel maximum diameter*	W9	387 (15.2)		
Steering wheel angle	H18	19.0		
Accel. heel pt. to steer. whl. cntr	L11			
Accel. heel pt. to steer. whl. cntr	H17			
Undepressed floor covering thickness	H67	6 (0.2)		

Front Compartment Int. Dim. Are Measured With The Seating Ref. Pt.

Rear Compartment

(SgRP) mm Forward And mm Upward of Rearmost Position.

SgRP point couple distance	L50	882 (34.7)		844 (33.2)
Effective head room	H63	971 (38.2)	965 (38.0)	999 (39.3)
Min. effective leg room	L51	992 (39.1)	983 (38.7) - 1B169	946 (37.2)
SgRP (second to heel)	H31	292 (11.5)		307 (12.1)
Knee clearance	L48	91 (3.6)		49 (1.9)
Shoulder room	W4	1537 (60.5)	1546 (60.9)	1548 (60.9)
Hip room	W8	1405 (55.3)		1398 (55.0)
*** Upper body opening to ground	H51			
Back angle (deg.)	L41	25.0		26.5
Hip angle (deg.)	L43	92.5		91.0
Knee angle (deg.)	L45	108.0		98.0
Foot angle (deg.)	L47	127.0		121.0
Depressed floor covering thickness	H73	18 (0.7)		

Luggage Compartment

Usable luggage capacity [L (cu. ft.)]	V1		Not Applicable
*** Liftover height	H195	827 (32.6)	

Interior Volumes (EPA Classification)

Vehicle class		Large	
Interior volume index (cu. ft.)**		110.3	110.5
Trunk / cargo index (cu. ft.)		20.9	50.4

* See page 14.

** Includes passenger and trunk / cargo index - see definition page 32.

*** EPA Loaded vehicle Weight, Loading Conditions

All linear dimensions are in millimeters (Inches).



MVMA Specifications

Vehicle Line CAPRICE
 Model Year 1990 Issued 8-89 Revised(*) 8-89

METRIC (U.S. Customary) Vehicle Dimensions

See Key Sheets for Definitions

Body Type

STATION WAGON - 3 SEAT
 1BN35

Station Wagon - Third Seat

SAE Ref. No.

	SAE Ref. No.	Value
Seat facing direction	SD1	Rearward
SgRP couple distance	L85	985 (38.8)
Shoulder room	W85	1240 (48.8)
Hip Room	W88	1109 (43.7)
Effective leg room	L88	782 (30.8)
Effective head room	H88	948 (37.3)
SgRP to heel point	H87	257 (10.1)
Knee clearance	L87	317 (12.5)
Back angle (deg.)	L88	25.0
Hip angle (deg.)	L89	76.5
Knee angle (deg.)	L90	70.5
Foot angle (deg.)	L91	114.5

Station Wagon - Cargo Space

	SAE Ref. No.	Value
Cargo length (open front)	L200	2790 (109.8)
Cargo length (open second)	L201	1907 (75.1)
Cargo length (closed front)	L202	2290 (90.2)
Cargo length (closed second)	L203	1407 (55.4)
Cargo length at belt (front)	L204	2128 (83.8)
Cargo length at belt (second)	L205	1222 (48.1)
Cargo width (wheelhouse)	W201	1224 (48.2)
Rear opening width at floor	W203	1238 (48.7)
Opening width at belt	W204	1224 (48.2)
* Min. rear opening width above belt	W205	988 (38.9)
Cargo height	H201	755 (29.7)
Rear opening height	H202	729 (28.7)
Tailgate to ground height	H250	768 (30.2)
Front seat back to load floor height	H197	Not Applicable
Cargo volume index [cu. m.(cu.ft.)]	V2	2488 (87.9)
Hidden cargo vol. index [cu.m.(cu.ft.)]	V4	Not Applicable
Cargo volume index-rear of 2-seat	V10	1428 (50.4)

Hatchback - Cargo Space

(NOT APPLICABLE)

	SAE Ref. No.	Value
Cargo length at front seatback height	L208	
Cargo length at floor (front)	L209	
Cargo length at second seatback height	L210	
Cargo length at floor (second)	L211	
Front seatback to load floor height	H197	
Second seatback to load floor height	H198	
Cargo volume index [cu. m. (cu. ft.)]	V3	
Hidden cargo vol. index [cu.m.(cu.ft.)]	V4	
Cargo volume index-rear of 2-seat	V11	

* EPA Loaded Vehicle Weight, Loading Conditions

All linear dimensions are in millimeters (Inches.)



MVMA Specifications

Vehicle Line CAPRICE/CAPRICE POLICE/CAPRICE FLEET
 Model Year 1990 Issued 6-89 Revised(*)

METRIC (U.S. Customary)

Body Type	4-DOOR SEDANS	4-DOOR STATION WAGON
	1BL89 1BN89 1BU89	1BN35

Vehicle Fiducial Marks

Number*	Define Coordinate Location		
Front	X	Fiducial Mark To Vertical Zero Grid Line - Front Measured Horizontally, From The Zero Grid Line To The Front Fiducial Mark Located On Top Of The Front Seat Adjuster Mounting Bolt.	
	Y	Fiducial Mark To Centerline Of Car - Front, Width Measurement Made From Centerline Car To Fiducial Mark Located On Top Of The Front Seat Adjuster Mounting Bolt.	
	Z	Fiducial Mark To Horizontal Zero Grid Line - Front, Measured Vertically From Zero Grid Line To Front Fiducial Mark Located On Top Of The Front Seat Adjuster Mounting Bolt.	
Rear	X	Fiducial Mark To Vertical Zero Grid Line - Rear, Measured Horizontally From The Zero Grid Line To Rear Fiducial Mark Located On The Rail (Compartment Pan - Longitudinal).	
	X	Fiducial Mark To Centerline Of Car - Rear, Width Measurement Made From Centerline Of Car To Fiducial Mark Located On The Rail (Compartment Pan - Longitudinal).	
	Z	Fiducial Mark To Horizontal Zero Grid Line - Rear, Measured Vertically From The Zero Grid Line To Rear Fiducial Mark Located On The Rail (Compartment Pan - Longitudinal).	
Fiducial Mark Number			
Front	W21*	564 (22.2)	
	L54*	754 (29.7)*	
	H81*	9 (0.4)#	
	H181*	348 (13.7)	349 (13.7)
	** H183*	325 (12.8)	332 (13.1)
Rear	W22*	254 (10.0)	302 (11.9)
	L55*	3533 (139.1)*	3440 (135.4)*
	H82*	86 (3.4)#	-34 (-1.3)#
	H182*	449 (17.7)	331 (13.0)
	** H184*	431 (17.0)	319 (12.6)
	* Vertical Base Grid 2000mm Line. # Horizontal Base Grid 500mm Line.		

* Reference - SAE Recommended Practice, J182, Motor Vehicle Fiducial Marks.

** EPA Loaded Vehicle Weight, Loading Conditions.

All Linear Dimensions Are In Millimeters (Inches).





MVMA Specifications
METRIC (U.S. Customary)

Vehicle Line CAPRICE/CAPRICE POLICE/CAPRICE FLEET
 Model Year 1990 Issued 6-89 Revised(*)

		Optional Equipment Differential Mass (weight)*			
Code	Equipment	MASS, kg. (lb.)			Remarks Restrictions, Requirements
		Front	Rear	Total	
AG2	Power Front Seat 6-Way Pass, Split Bench (Used With AG1 & AG9) Requires A31	2.6 (5.7)	2.4 (5.3)	5.0 (11.0)	
AN4	Childseat Tether Restraint - Provisions	0 (0)	0.2 (0.4)	0.2 (0.4)	All Models - Canadian Only
AP9	Cargo Net - Restraint	0 (0)	0.2 (0.4)	0.2 (0.4)	Sedans Only
AT8	Reclining Seat Back Included With RPO AV7/AM6 R.H. Seat Back Only	0.6 (1.3)	1.0 (2.2)	1.6 (3.5)	1BL & 1BN69, Standard On 1BU69
AU3	Electric Side Door Lock System	1.6 (3.5)	1.4 (3.1)	3.0 (6.6)	1BL & BN69, Standard On 1BU69
AU6	Power Tailgate Lock	-0.2 (-0.4)	1.4 (3.1)	1.2 (2.6)	1BN35
AV7	Front Seat - 50/50	2.2 (4.9)	2.6 (5.7)	4.8 (10.58)	1BL00 & 1BN00 Models
A31	Electric Window Control	2.2 (4.8)	3.2 (7.0)	5.4 (11.8)	
A90	Trunk Lid Release - Electric Remote	0 (0)	0.6 (1.3)	0.6 (1.3)	
BC5	Deluxe Cargo Area Included With RPO-B39	0 (0)	0.6 (1.3)	0.6 (1.3)	1BN35
BX3	Woodgrain Applique And Molding (Body Side And Tailgate. Not With RPO-D84).	1.0 (1.8)	2.0 (3.5)	3.0 (5.3)	1BN35
B34	Floor Mats - Front (Carpeted)	1.6 (3.5)	0.6 (1.3)	2.2 (4.8)	

* Also see Engine - General Section for dressed engine mass (weight).



MVMA Specifications
METRIC (U.S. Customary)

Vehicle Line CAPRICE/CAPRICE POLICE/CAPRICE FLEET
 Model Year 1990 Issued 6-89 Revised(*) _____

		Optional Equipment Differential Mass (weight)*			
Code	Equipment	MASS, kg. (lb.)			Remarks Restrictions, Requirements
		Front	Rear	Total	
B35	Floor Mats - Rear (Carpeted)	0.2 (0.4)	1.0 (2.2)	1.2 (2.6)	
B39	Carpet - Deluxe Load Floor - Color Keyed	-0.4 (-0.9)	2.6 (5.7)	2.2 (4.8)	1BN35
B48	Deluxe Luggage Compartment Trim	0.0 (0.0)	4.4 (9.7)	4.4 (9.7)	1BL69, 1BN69, 1BU69
B84	Body Side Molding	0.2 (0.4)	0.6 (1.3)	0.8 (1.8)	All Models (Except 1BN35, 1BN35, With BX3 Optional)
B96	Molding - Wheel Opening	0.2 (0.4)	0.2 (0.4)	0.4 (0.9)	1BL00, Base On 1BN & 1BU69 Models
CD4	Windshield Wipers And Washers - Pulse Type	0.2 (0.4)	0 (0)	0.2 (0.4)	
C09	Vinyl Roof Cover - Full Padded	1.2 (2.6)	2.2 (4.8)	3.4 (7.5)	1BL69, 1BN69
CB4	Landau Top - Formal	2.2 (4.8)	7.8 (17.2)	10.0 (22.0)	1BU69
C49	Electroclear Rear Window Defogger	0 (0)	0.4 (0.9)	0.4 (0.9)	1BL, 1BN & 1BU69
		0 (0)	0.6 (1.3)	0.6 (1.3)	1BN35
C51	Air Deflector, Rear Window, (Forces RPO-V55)	-1.0 (-2.2)	2.6 (5.7)	1.6 (3.5)	1BN35
C93	Lamp Oper	0.4 (0.9)	0.6 (1.3)	1.0 (2.2)	1BU69

* Also see Engine - General Section for dressed engine mass (weight).



MVMA Specifications

METRIC (U.S. Customary)

Vehicle Line CAPRICE/CAPRICE POLICE/CAPRICE FLEET
 Model Year 1990 Issued 6-89 Revised(*)

		Optional Equipment Differential Mass (weight)*			
Code	Equipment	MASS, kg. (lb.)			Remarks Restrictions, Requirements
		Front	Rear	Total	
D64	Visor Vanity Mirror - RH Visor - Illuminated	0.4 (0.9)	0 (0)	0.4 (0.9)	1BN & 1BU69
D68	Outside Mirrors - LH and RH Remote Control, Painted	0.8 (1.8)	0.4 (0.9)	1.2 (2.6)	1BL & 1BN69 & 35
		0.4 (0.9)	0 (0)	0.4 (0.9)	1BU69
F40	Suspension - Heavy Duty Front & Rear (N/A F41 Suspension)	0 (0)	0.8 (1.8)	0.8 (1.8)	1BL69, 1BN69, 1BU69 Standard On 1BN35
F41	Sport Suspension Equipment - Front & Rear. Requires RPO-QHJ, PH1, GU4	5.0 (11.0)	8.6 (19.0)	13.6 (30.0)	1BL69, 1BN69, 1BU69 Not Available W/G80
G66	Air Booster Rear Shock Absorbers	0 (0)	0.6 (1.3)	0.6 (1.3)	1BN35
K05	Engine Block Heater	0.4 (0.9)	0 (0)	0.4 (0.9)	
K34	Cruise Control - 3 Mode (Cruise Master), With Resume Feature	1.8 (4.0)	0.2 (0.4)	2.0 (4.4)	
L05	Engine 5.7 Liter (350 CID) Electronic Fuel Injection V8	8.2 (13.7)	2.0 (4.4)	8.2 (18.1)	1BL69 - Police Only
N33	Tilt Steering Column (Comfortilt)	0.8 (1.8)	0.2 (0.4)	1.0 (2.2)	
PB2	Wheel Trim Covers - Sport	-1.6 (-3.5)	-1.4 (-3.1)	-3.0 (-6.6)	1BL & 1BU69, Base For 1BU69

* Also see Engine - General Section for dressed engine mass (weight).



MVMA Specifications

METRIC (U.S. Customary)

Vehicle Line CAPRICE/CAPRICE POLICE/CAPRICE FLEET
 Model Year 1990 Issued 6-89 Revised(*)

		Optional Equipment Differential Mass (weight)*			
Code	Equipment	MASS, kg. (lb.)			Remarks Restrictions, Requirements
		Front	Rear	Total	
TR9	Auxiliary Lighting Group Consists Of:	0.2 (0.4)	0.0 (0.0)	0.2 (0.4)	1BL & 1BN69, Standard On 1BU69
U26	Underhood Lamp	0 (0)	0 (0)	0 (0)	1BL & 1BN69, Standard On 1BU69
U29	Instrument Panel Courtesy Lamps	0.2 (0.4)	0 (0)	0.2 (0.4)	1BL69 Standard On 1BU69, 1BN69 & 35
C95	Dome Reading Lamp	0.4 (0.9)	0 (0)	0.4 (0.9)	1BL & 1BN69, Standard On 1BU69
T87	Cornering - Lamps	1.4 (3.1)	-0.2 (-0.4)	1.2 (2.7)	1BN & 1BU69 Only
U14	Gauge Package Consists Of: Gauges and Trip Odometer	0.2 (0.4)	0 (0)	0.2 (0.4)	
UM6	AM/FM Stereo Radio With Clock And Cass. Player - Consists Of RPO-U64, U79, UQ1	0.6 (1.3)	0.2 (0.4)	0.8 (1.8)	
UU6	AM/FM Stereo/Radio With Equalizer, Cass., Clock - Consists Of RPO U79, U64 & UQ1	0.6 (1.3)	0.2 (0.4)	0.8 (1.8)	
U75	Power Antenna Radio Suppression Equipment	0.8 (1.8)	0.2 (0.4)	1.0 (2.2)	1BN/1BU69
T82	Twilight Sentinel	0.2 (0.4)	0 (0)	0.2 (0.4)	1BN/1BU69
U79	Speakers, Extended Range Dual Front, Dual Rear Used with UK4, UM6, UM7, or UU6	0 (0)	1.0 (2.2)	1.0 (2.2)	1BL, 1BN, 1BU69
VE5	Bumper Impact Strips, Front And Rear	1.2 (2.6)	1.0 (2.2)	2.2 (4.8)	1BL69, Standard On 1BN69 & 35 And 1BU69.

* Also see Engine - General Section for dressed engine mass (weight).





MVMA Specifications
METRIC (U.S. Customary)

Exterior Vehicle And Body Dimensions – Key Sheet

Exterior Width

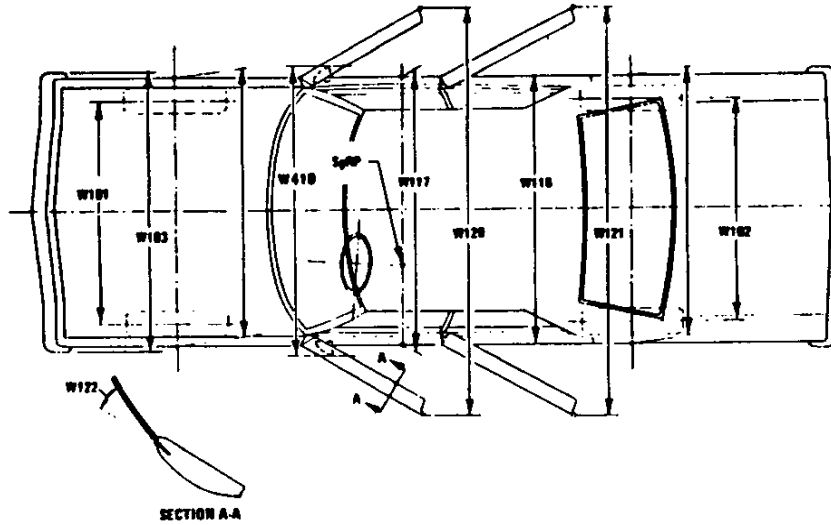

Exterior Length & Height

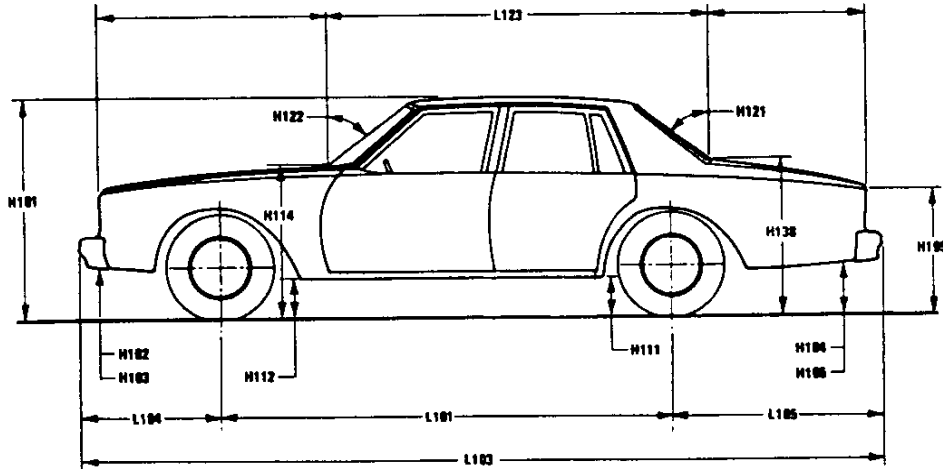

Exterior Ground Clearance

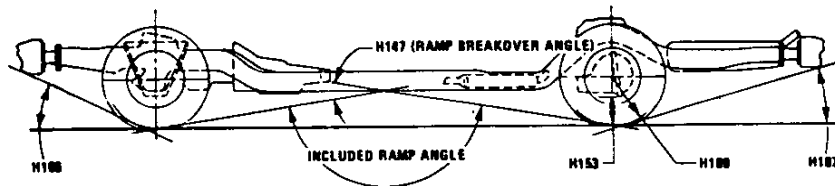



MVMA Specifications Form

METRIC (U.S. Customary)

Interior Vehicle And Body Dimensions - Key Sheet

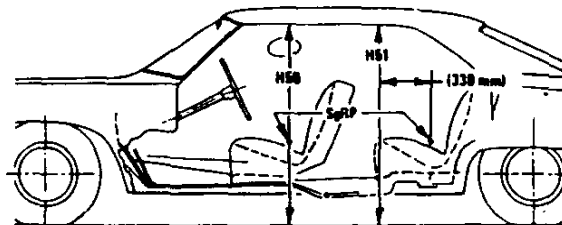
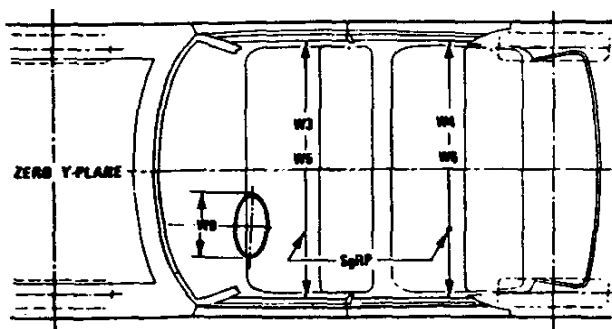
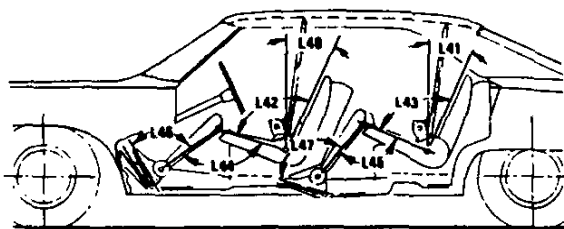
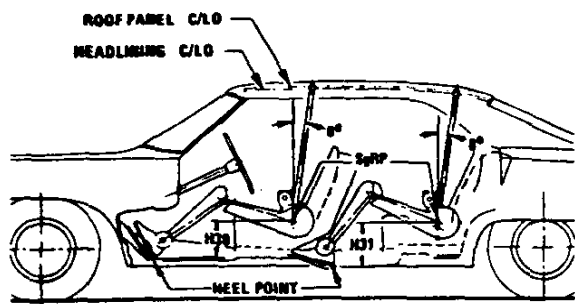
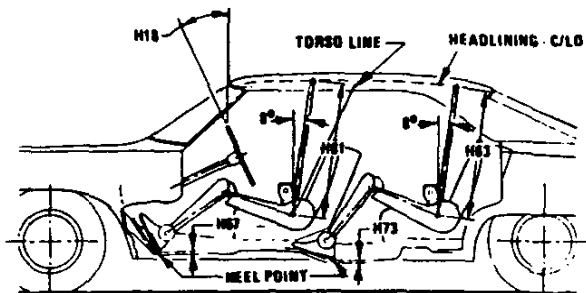
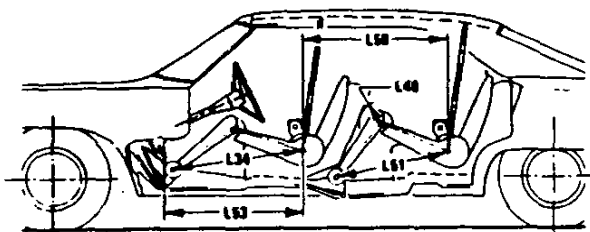

MVMA Specifications Form
METRIC (U.S. Customary)

Interior Vehicle And Body Dimensions – Key Sheet

Third Seat

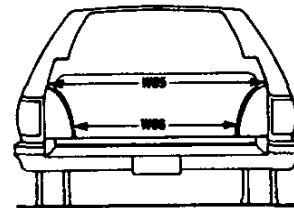
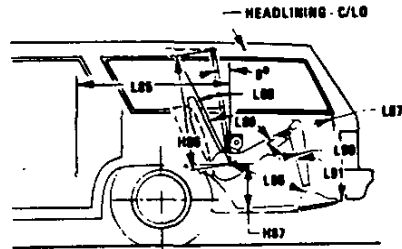

Cargo Space

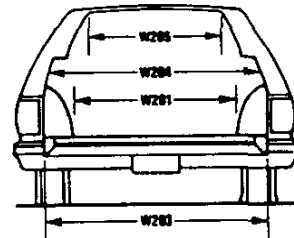
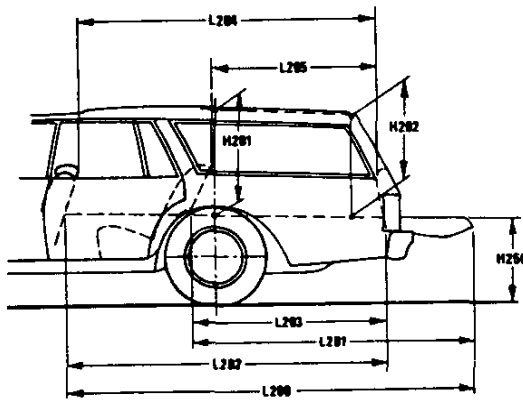

Station Wagon

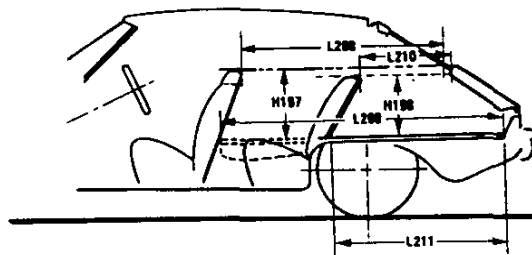

Hatchback

MVMA Specifications

METRIC (U.S. Customary)

Exterior Vehicle And Body Dimensions – Key Sheet Dimensions Definitions

Seating Reference Point

SEATING REFERENCE POINT means the manufacturer's design reference point which –

- (a) Establishes the rearmost normal design driving or riding position of each designated seating position in a vehicle;
- (b) Has coordinates established relative to the design vehicle structure;
- (c) Simulates the position of the pivot center of the human torso and thigh; and
- (d) Is the reference point employed to position the two dimensional templates described in SAE Recommended Practice J826, "Devices for Use in Defining and Measuring Vehicle Seating Accommodations."

Width Dimensions

- W101 TREAD – FRONT. The dimension measured between the tire centerlines at the ground.
- W102 TREAD – REAR. The dimension measured between the tire centerlines at the ground. In case of dual wheels, the dimension will be measured to the centerline of tire and wheel assemblies.
- W103 VEHICLE WIDTH. The maximum dimension measured between the widest point on the vehicle, excluding exterior mirrors, flexible mud flaps, marker lamps, but including bumpers, moldings, sheet metal protrusions or dual wheels, if standard equipment.
- W117 BODY WIDTH AT SgRP – FRONT. The dimension measured laterally between the widest points on the body at the SgRP-front, excluding door handles, applied moldings, or appliques.
- W120 VEHICLE WIDTH – FRONT DOORS OPEN. The dimension measured between the widest point on the front doors in maximum hold-open position.
- W121 VEHICLE WIDTH – REAR DOORS OPEN. The dimension measured between the widest point on the rear doors in maximum hold-open position. For vehicles with a rear door on only one side, this dimension is to the zero "Y" plane.
- W122 TUMBLE – HOME. STRAIGHT SIDE GLASS. The angle measured from a vertical to the outside surface of the front door glass at the SgRP "X" plane.
CURVED SIDE GLASS. The angle measured from a vertical to a chord extending from the upper DLO to the lower DLO at the outside surface of the front door glass at the front SgRP "X" plane.
- W410 OUTSIDE MIRROR WIDTH: The dimension between the widest point on the outside mirrors. The standard right and left mirror adjusted for normal driving will be shown unless otherwise noted. When only one outside mirror is standard, the dimension will be to the zero "Y" plane.

Length Dimensions

- L101 WHEELBASE (WB). The dimension measured longitudinally between front and rear wheel centerlines. In case of dual rear axles, the dimension shall be to the midpoint of the centerlines of the rear wheels.
- L103 VEHICLE LENGTH. The maximum dimension measured longitudinally between the foremost point and the rearmost point on the vehicle, including bumper, bumper guards, tow hooks and/or rub strips, if standard equipment.
- L104 OVERHAND – FRONT. The dimension measured longitudinally from the centerline of the front wheels to the foremost point on the vehicle including bumper, bumper guards, tow hooks and/or rub strips, if standard equipment.
- L105 OVERHANG – REAR. The dimension measured longitudinally from the centerline of the rear wheels; or in the case of dual rear axles, the dimension shall be the midpoint of the centerlines of the rear wheels, to the rearmost point on the vehicle including rear bumpers, bumper guards, tow hooks and rub strips, if standard equipment.

- L123 UPPER STRUCTURE LENGTH. The dimension measured longitudinally from the cowl point to the deck point.
- L127 REAR WHEEL CENTERLINE "X" COORDINATE or in the case of dual rear axles, the coordinate shall be the midpoint of the distance between the rear axle centerlines.

Height Dimensions

- H101 VEHICLE HEIGHT. The dimension measured vertically from the highest point on the vehicle body to ground.
- H111 ROCKER PANEL – REAR TO GROUND. The dimension measured vertically from the bottom of the rocker or side quarter panel at the front of the rear wheel opening, excluding flanges, to ground.
- H112 ROCKER PANEL – FRONT TO GROUND. The dimension measured vertically from the foremost point on the bottom of the rocker panels, excluding flanges, to ground.
- H114 COWL POINT TO GROUND. Measured at zero "Y" plane.
- H121 BACKLIGHT SLOPE ANGLE. The angle between the vertical reference line and the surface of backlight at vehicle zero "Y" plane. For curve backlight, the angle is to chord of backlight arc from lower DLO to upper DLO.
- H122 WINDSHIELD SLOPE ANGLE. The angle between the vertical reference line and a chord of the windshield arc running from the lower DLO to the upper DLO at the vehicle zero "Y" plane. In the case of wrap over glass, the angle to be measured will be formed by a chord 457 mm (18.0 in.) long drawn from the lower DLO to the intersecting point on the windshield.
- H138 DECK POINT TO GROUND. Measured at zero "Y" plane.
- H109 STATIC LOAD – TIRE RADIUS – REAR. Specified by the manufacturer in accordance with composite TIRE SECTION STANDARD.

Ground Clearance Dimensions

- H102 FRONT BUMPER TO GROUND. The minimum dimension measured vertically from the lowest point on the front bumper to ground, including bumper guards, if standard equipment.
- H103 FRONT BUMPER TO GROUND – CURB MASS (WT.). Measured in the same manner as H102.
- H104 REAR BUMPER TO GROUND. The minimum dimension measured vertically from the lowest point on the rear bumper to ground, including bumper guards, if standard equipment.
- H105 REAR BUMPER TO GROUND – CURB MASS (WT.). Measured in the same manner as H104.
- H106 ANGLE OF APPROACH. The angle measured between a line tangent to the front tire static loaded radius arc and the initial point of structural interference forward of the front tire to ground. The limiting structural component shall be designated.
- H107 ANGLE OF DEPARTURE. The angle measured between a line tangent to the rear tire static loaded radius arc and the initial point structural interference rearward of the rear tire to ground. The limiting component shall be designated.
- H147 RAMP BREAKOVER ANGLE. The angle measured between two lines tangent to the front and rear tire static loaded radius and intersecting at a point on the underside of the vehicle which defines the largest ramp over which the vehicle can roll.
- H153 REAR AXLE DIFFERENTIAL TO GROUND. The minimum dimension measured from the rear axle differential to ground.
- H156 MINIMUM RUNNING GROUND CLEARANCE. The minimum dimension measured from the sprung vehicle to ground. Specify location.

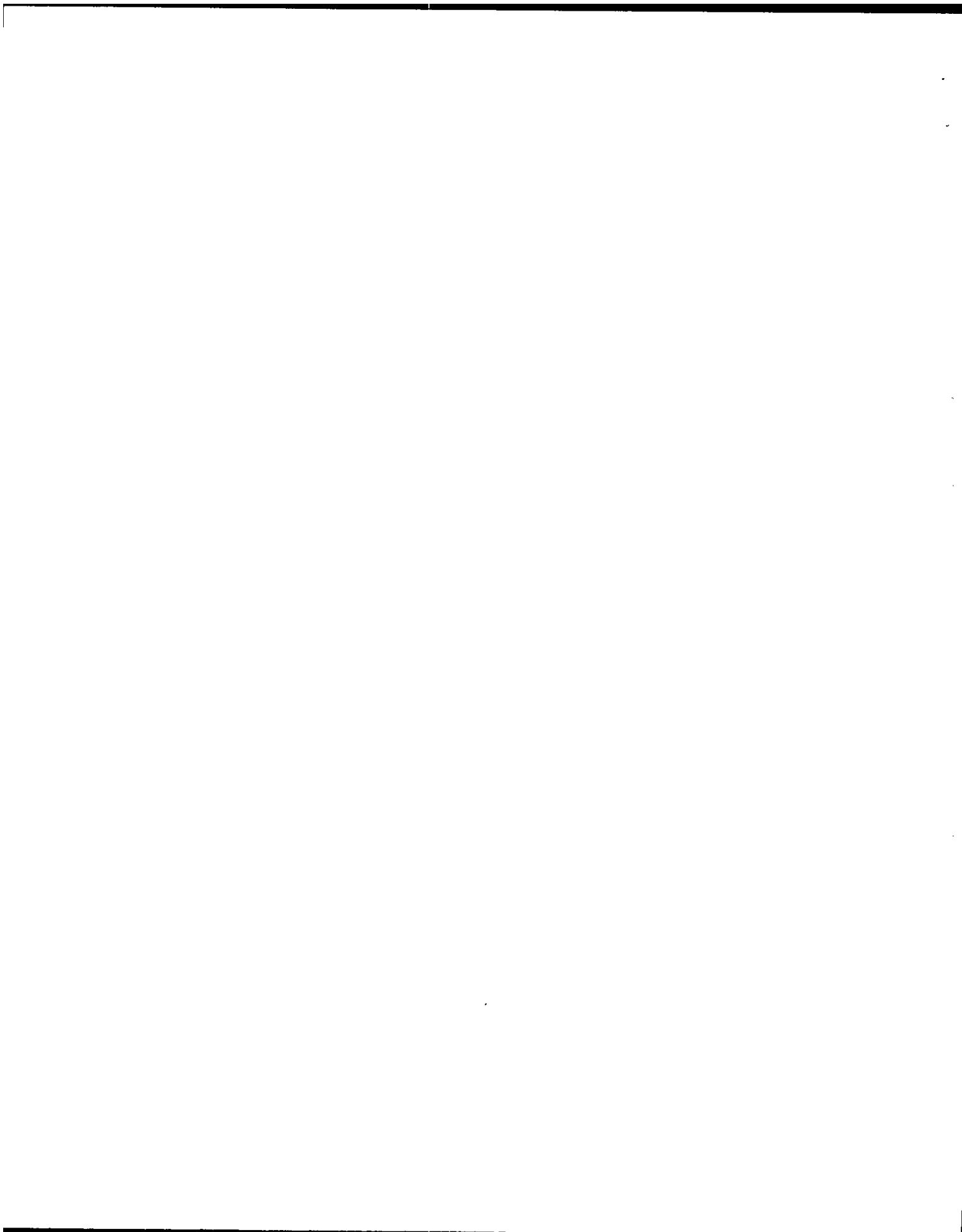

MVMA Specifications

METRIC (U.S. Customary)

Interior Vehicle And Body Dimensions – Key Sheet Dimensions Definitions

Glass Areas

- S1 Windshield area.
- S2 Side windows area. Includes the front door, rear door, vents, and rear quarter windows on both sides of the vehicle.
- S3 Backlight areas.
- S4 Total area. Total of all areas (S1 + S2 + S3).

Fiducial Mark Dimensions

Fiducial Mark – Number 1

- L54 "X" coordinate.
- W21 "Y" coordinate.
- H81 "Z" coordinate.
- H161 Height "Z" coordinate to ground at curb weight.
- H163 Height "Z" coordinate to ground.

Fiducial Mark – Number 2

- L55 "X" coordinate.
- W22 "Y" coordinate.
- W82 "Z" coordinate.
- H162 Height "Z" coordinate to ground at curb weight.
- H164 Height "Z" coordinate to ground.

Front Compartment Dimensions

- L11 ACCELERATOR HEEL POINT TO STEERING WHEEL CENTER. The dimension measured horizontally from the AHP to the intersection of the steering column centerline and a plane tangent to the upper surface of the steering wheel rim.
- L17 DESIGN H-POINT – FRONT TRAVEL. The dimension measured horizontally between the design H-point – front in the foremost and rearmost seat track positions. (See SAE J1100)
- L23 NORMAL DRIVING AND RIDING SEAT TRACK TRAVEL. The dimension measured horizontally between a point on the design H-point travel line from the SgRP to the displaced point on the design H-point travel line with the seat moved to the foremost seat position, but not to include seat track travel used for purposes other than normal driving and riding positions. (See SAE J1100).
- L31 SgRP – FRONT. "X" COORDINATED.
- L34 MAXIMUM EFFECTIVE LEG ROOM – ACCELERATOR. The dimension measured along a line from the ankle pivot center to the SgRP – front plus 254 mm (10.0 in.) measured with right foot on the undepressed accelerator pedal. For vehicles with SgRP to heel (H30) greater than 18 in., the accelerator pedal may be depressed as specified by the manufacturer. If the accelerator is depressed, the manufacturer shall place foot flat on pedal and note the depression of the pedal.
- L-40 BACK ANGLE – FRONT. The angle measured between a vertical line through the SgRP – front and the torso line. If the seatback is adjustable, use the normal driving and riding position specified by the manufacturer.
- L-42 HIP ANGLE – FRONT. The angle measured between torso line and thigh centerline.
- L44 KNEE ANGLE – FRONT. The angle measured between thigh centerline and lower leg centerline measured on the right leg.
- L46 FOOT ANGLE – FRONT. The angle measured between the lower leg centerline and a line tangent to the ball and heel of the bare foot flesh line measured on the right leg. Ref SAE J826.
- L53 SgRP – FRONT TO HEEL. The dimension measured horizontally from the SgRP – front to the accelerator heel point.
- W3 SHOULDER ROOM – FRONT. The minimum dimension measured laterally between the trimmed surfaces on the "X" plane through the SgRP – front at height between the belt line and 254 mm (10.0 in.) above the SgRP – front, excluding the door assist strap and attaching parts.

- W5 HIP ROOM – FRONT. The minimum dimension measured laterally between the trimmed surfaces on the "X" plane through the SgRP – front within 25 mm (1.0 in.) below and 76 mm (3.0 in.) above the SgRP – front and 76 mm (3.0 in.) fore and aft of the SgRP – front.
- W9 STEERING WHEEL MAXIMUM OUTSIDE DIAMETER. Define if other than round.
- H7 ACCELERATOR HEEL POINT TO THE STEERING WHEEL CENTER. The dimension measured vertically from the AHP – front to the intersection of the steering column centerline to a plane tangent to the upper surface of the steering wheel rim.
- H18 STEERING WHEEL ANGLE. The angle measured from a vertical to the surface plane of the steering wheel.
- H30 SgRP – FRONT TO HEEL. The dimension measured vertically from the SgRP – front to the accelerator heel point.
- H50 UPPER BODY OPENING TO GROUND – FRONT. The dimension measured vertically from the trimmed body opening to the ground on the SgRP – front "X" plane.
- H61 EFFECTIVE HEAD ROOM – FRONT. The dimension measured along a line 8 deg. rear of vertical from the SgRP – front to the headlining plus 102 mm (4.0 in.).
- H67 FLOOR COVERING THICKNESS – UNDEPRESSED – FRONT. The dimension measured vertically from the surface of the undepressed floor covering to the underbody sheet metal at the accelerator heel point.

Rear Compartment Dimensions

- L-41 BACK ANGLE – SECOND. The angle measured between a vertical line through the SgRP – second and the torso line.
- L43 HIP ANGLE – SECOND. The angle measured between torso line and thigh centerline.
- L45 KNEE ANGLE – SECOND. The angle measured between thigh centerline and lower leg centerline.
- L47 FOOT ANGLE – SECOND. The angle measured between the lower leg centerline and a line tangent to the ball and heel of the three-dimensional devices bare foot flesh line (Reference J826).
- L48 KNEE CLEARANCE – SECOND. The minimum dimension measured from the knee pivot center to the back of the front seatback minus 51 mm (2.0 in.).
- L50 SgRP COUPLE DISTANCE – SECOND. The dimension measured horizontally from the driver SgRP – front to the SgRP – second.
- L51 MINIMUM EFFECTIVE LEG ROOM – SECOND. The dimension measured along a line from the ankle pivot center to the SgRP – second plus 254 mm (10.0 in.).
- W4 SHOULDER ROOM – SECOND. The minimum dimension measured laterally between door or quarter trimmed surfaces on the "X" plane through the SgRP – second at height between 254-406 mm (10.0-16.0 in.) above the SgRP – second, excluding the door assist straps and attaching parts.
- W6 HIP ROOM – SECOND. Measured in the same manner as W5.
- H31 SgRP – SECOND TO HEEL. The dimension measured vertically from the SgRP – second to the two dimensional device heel point on the depressed floor covering.
- H51 UPPER BODY OPENING TO GROUND – SECOND. The dimension measured vertically from the trimmed body opening to the ground on the "X" plane 330 mm (13.0 in.) forward of the SgRP – second.
- H63 EFFECTIVE HEAD ROOM – SECOND. The dimension measured along a line 8 deg. rear of vertical from the SgRP to the headlining, plus 102 mm (4.0 in.).
- H73 FLOOR COVERING – DEPRESSED – SECOND. The dimension measured vertically from the heel point to the underbody sheet metal.

MVMA Specifications

METRIC (U.S. Customary)

Interior Vehicle And Body Dimensions – Key Sheet Dimensions Definitions

Luggage Compartment Dimensions

V1 USABLE LUGGAGE CAPACITY—Total of volumes of individual pieces of standard luggage set plus H-boxes stowed in the luggage compartment in accordance with the procedure described in paragraph 8.2 of SAE-J1100a.

Interior Volumes (EPA Classification)

The Interior Volume Index is listed for each body style except two seaters. The Interior Volume Index estimates the space in a car. It is based on four measurements – head room, shoulder room, hip room, and leg room – for the front and rear seats, plus trunk capacity. The Interior Volume Index is an estimate of the size of the passenger compartment.

The Trunk/Cargo Index is an estimate of the size of the trunk/cargo space. In station wagons and hatchbacks it is an estimate of the space behind the second seat.

Station Wagon – Third Seat Dimensions

- L85 SgRP COUPLE DISTANCE – THIRD. The dimension measured horizontally from the SgRP – second to the SgRP – third.
- L86 EFFECTIVE LEG ROOM – THIRD. The dimension measured along a line from the ankle pivot center to the SgRP – third plus 254 mm (10.0 in.).
- L87 KNEE CLEARANCE – THIRD. The minimum dimension from the knee pivot center to the back of second seatback minus a constant of 51 mm (2.0 in.). With rear-facing third seat, dimension is measured to closure.
- L88 BACK ANGLE – THIRD. Measured in the same manner as L41.
- L89 HIP ANGLE – THIRD. Measured in the same manner as L43.
- L90 KNEE ANGLE – THIRD. Measured in the same manner as L45.
- L91 FOOT ANGLE – THIRD. Measured in the same manner as L47.
- W85 SHOULDER ROOM – THIRD. Measured in the same manner as W4.
- W86 HIP ROOM – THIRD. Measured in the same manner as W5.
- H86 EFFECTIVE HEAD ROOM – THIRD. The dimension, measured along a line 8 deg. from the SgRP – third to the headlining rear of vertical plus a constant of 102 mm (4.0 in.).
- H87 SgRP – THIRD TO HEEL POINT.
- SD1 SEAT FACING DIRECTION – THIRD.

Station Wagon – Cargo Space Dimensions

- L200 CARGO LENGTH – OPEN – FRONT. The minimum dimension measured longitudinally from the back of the front seatback at the height of the undepressed floor covering to the rearmost point on the undepressed floor covering on the open tailgate or cargo surface if the rear closure is a conventional door type tailgate at the zero "Y" plane.
- L201 CARGO LENGTH – OPEN – SECOND. The dimension measured longitudinally from the back of the second seatback at the height of the undepressed floor covering to the rearmost point on the undepressed floor covering on the open tailgate or cargo floor surface if the rear closure is a conventional door type tailgate, at the zero "Y" plane.

- L202 CARGO LENGTH – CLOSED – FRONT. The minimum dimension measured horizontally from the back of the front seat at the height of the undepressed floor covering to the rearmost point on the undepressed floor covering on the closed tailgate or taildoor for station wagons, trucks and mpv's at the zero "Y" plane.
- L203 CARGO LENGTH – CLOSED – SECOND. The dimension measured horizontally from the back of the second seat at the height of the undepressed floor covering to the rearmost point on the undepressed floor covering on the closed tailgate or taildoor for station wagons, trucks and mpv's at the zero "Y" plane.
- L204 CARGO LENGTH AT BELT – FRONT. The minimum dimension measured horizontally from the back of the front seatback at the seatback top to the foremost normal surface of the closed tailgate or inside surface of the cab backpanel at the height of the belt, on the zero "Y" plane.
- L205 CARGO LENGTH AT BELT – SECOND. The minimum dimension measured horizontally from the back of the second seatback at the seatback top to the foremost normal surface of the closed tailgate at the height of the belt, on the zero "Y" plane.
- W201 CARGO WIDTH – WHEELHOUSE. The minimum dimension measured laterally between the trimmed wheelhousings at floor level. For any vehicle not trimmed, measure to the sheet metal.
- W203 REAR OPENING WIDTH AT FLOOR. The minimum dimension measured laterally between the limiting interferences of the rear opening at floor level.
- W204 REAR OPENING WIDTH AT BELT. The minimum dimension measured laterally between the limiting interferences of the rear opening at belt height or top of pick up box.
- W205 REAR OPENING WIDTH ABOVE BELT. The minimum dimension measured laterally between the limiting interferences of the rear opening above the belt height.
- H197 FRONT SEATBACK TO LOAD FLOOR HEIGHT. The dimension measured vertically from the horizontal tangent to the top of the seatback to the undepressed floor covering.
- H201 CARGO HEIGHT. The dimension measured vertically from the top of the undepressed floor covering to the headlining at the rear wheel "X" coordinate on the zero "Y" plane.
- H202 REAR OPENING HEIGHT. The dimension measured vertically from the top of the undepressed floor covering to the upper trimmed opening on the zero "Y" plane with rear door fully open.
- H250 TAILGATE TO GROUND CURB MASS (WT.). The dimension measured vertically from the top of the undepressed floor covering on the lowered tailgate to ground on the zero "Y" plane.
- V2 STATION WAGON

Measured in inches:

$$\frac{W4 \times H201 \times L204}{1728} = \text{ft}^3$$

Measured in mm:

$$\frac{W4 \times H201 \times L204}{10^9} = \text{m}^3 \text{ (cubic meter)}$$



MVMA Specifications

METRIC (U.S. Customary)

Interior Vehicle And Body Dimensions – Key Sheet Dimensions Definitions

V4 HIDDEN LUGGAGE CAPACITY – REAR OF FRONT SEAT.
The total volumes of individual pieces of one set of standard luggage stowed in any hidden cargo area below the load floor rear of the front seat.

V5 TRUCKS AND MPV'S WITH OPEN AREA.

Measured in inches:

$$\frac{L506 \times W505 \times H503}{1728} = \text{ft}^3$$

Measured in mm:

$$\frac{L506 \times W500 \times H503}{10^9} = \text{m}^3 \text{ (cubic meter)}$$

V6 TRUCKS AND MPV'S WITH CLOSED AREA.

Measured in inches:

$$\frac{L204 \times W500 \times H505}{1728} = \text{ft}^3$$

Measured in mm:

$$\frac{L204 \times W500 \times H505}{10^9} = \text{m}^3 \text{ (cubic meter)}$$

V8 HIDDEN LUGGAGE CAPACITY – REAR OF SECOND SEAT. The total volume of individual pieces of one set of standard luggage stowed in any hidden cargo area below the load floor rear of the second seat.

V10 STATION WAGON CARGO VOLUME INDEX.

Measured in inches:

$$\frac{H201 \times L205 \times \frac{W4 + W201}{2}}{1728} = \text{ft}^3$$

Measured in mm:

$$\frac{H201 \times L205 \times \frac{W4 + W201}{2}}{10^9} = \text{m}^3 \text{ (cubic meter)}$$

Hatchback – Cargo Space Dimensions

All hatchback cargo dimensions are to be taken with the front seat in full down and rear position, and the rear seat folded down. The hatchback door is in the closed position. (For electronically adjusted seats, see the manufacturer's specifications for Design "H" Point).

L208 CARGO LENGTH AT FRONT SEATBACK HEIGHT. The minimum horizontal dimension from the "X" plane tangent to the rearmost surface of the driver's seatback to the inside limiting interference of the hatchback door on the vehicle zero "Y" plane.

L209 CARGO LENGTH AT FLOOR – FRONT – HATCHBACK. The minimum horizontal dimension measured at floor level from the rear of the front seatback to the normal limiting interference of the hatchback door on the vehicle zero "Y" plane.

L210 CARGO LENGTH AT SECOND SEATBACK HEIGHT – HATCHBACK. The minimum dimension measured from the "X" plane tangent to the rearmost surface of second seatback or the load floor which is stowed at least one half of the H198 dimension height above the rear load floor, to the rearmost inside limiting interference on the zero "X" plane.

L211 CARGO LENGTH AT FLOOR – SECOND HATCHBACK. The minimum horizontal dimension measured at floor level from the rear of the second seatback or load floor panel to the normal limiting interference of the hatchback door on the vehicle zero "Y" plane.

H197 FRONT SEATBACK TO LOAD HEIGHT. The dimension measured vertically from the horizontal tangent to the top of the seatback to the undepressed floor covering.

H198 SECOND SEATBACK TO LOAD FLOOR HEIGHT: The dimension measured vertically from the second seatback to the undepressed floor covering.

V3 HATCHBACK.

Measured in inches:

$$\frac{\frac{L208 + L209}{2} \times W4 \times H197}{1728} = \text{ft}^3$$

Measured in mm:

$$\frac{\frac{L208 + L209}{2} \times W4 \times H197}{10^9} = \text{m}^3 \text{ (cubic meter)}$$

V4 HIDDEN LUGGAGE CAPACITY – REAR OF FRONT SEAT. The total volumes of individual pieces of one set of standard luggage stowed in any hidden cargo area below the load floor rear of the front seat.

V11 HATCHBACK CARGO VOLUME INDEX. Usable luggage (one (1) stand and luggage set) below floor:

Measured in inches:

$$\frac{\frac{L210 + L211}{2} \times W4 \times H198}{1728} = \text{ft}^3$$

Measured in mm:

$$\frac{\frac{L210 + L211}{2} \times W4 \times H198}{10^9} = \text{m}^3 \text{ (cubic meter)}$$



MVMA Specifications

METRIC (U.S. Customary)

Index

Subject	Page No.	Subject	Page No.
Alternator	16	Passenger Capacity	1
Axle Drive, Front, Rear, All Four	2, 9, 10	Passenger Mass Distribution	25
Axle Shafts	10	Pistons	3
Battery	16	Power Brakes	12
Body and Miscellaneous Information	17	Power, Engine	2
Brakes - Parking Service	12, 13	Power Steering	14
Camber	15	Power Teams	2
Camshaft	3	Propeller Shaft	10
Capacities		Pumps - Fuel	6
Cooling System	5	Water	5
Fuel Tank	6	Radiator - Cap, Hoses, Core	5
Lubricants		Ratios - Axle, Transaxle	2, 9, 10
Engine Crankcase	4	Compression	2
Transmission / Transaxle	8, 9	Steering	14
Rear Axle	10	Transmission / Transaxle	2, 8, 9
Carburetor	2, 6	Rear Axle	2, 10
Caster	15	Regulator - Alternator	16
Clutch - Pedal Operated	8	Restraint System	18
Coil, Ignition	16	Rims	13
Connecting Rods	4	Rods - Connecting	4
Convenience Equipment	19-20	Scrub Radius	14
Cooling System	5	Seats	17
Crankshaft	4	Shock Absorbers, Front & Rear	11
Cylinders and Cylinder Head	3	Spark Plugs	16
Diesel Information	4	Speedometer	15
Dimension Definitions		Springs - Front & Rear Suspension	11
Key Sheet - Exterior	27, 30, 31	Stabilizer (Sway Bar) - Front & Rear	11
Key Sheet - Interior	28, 29, 31, 32, 33	Starting System	16
Electrical System	15, 16	Steering	14
Emission Controls	7	Suppression - Ignition, Radio	16
Engine - General		Suspension - Front & Rear	11
Bore, Stroke, Type	3	Tail Pipe	7
Compression Ratio	2	Theft Protection	20
Displacement	2, 3	Thermostat, Cooling	5
Firing Order, Cylinder Numbering	3	Tires	13
General Information, Power & Torque	2	Toe-In	15
Intake System	4	Torque Converter	9
Power Teams	2	Torque - Engine	2, 8, 9
Exhaust System	7	Transaxle	9
Equipment Availability, Convenience	19	Transmission - Types	2, 8, 9
Fan, Cooling	5	Transmission - Automatic	2, 9
Filters - Engine Oil, Fuel System	4	Transmission - Manual	2, 8
Four Wheel Drive	10	Transmission - Ratios	2, 8, 9
Frame	18	Tread	21
Front Suspension	11	Trunk Cargo Load	1
Front Wheel Drive Unit	10	Trunk Luggage Capacity	22
Fuel System	6	Turning Diameter	14
Fuel Injection	6	Unitized Construction	18
Fuel Tank	6	Universal Joints, Propeller Shaft	10
Glass	18	Valve System	4
Headlamps	18	Vehicle Dimensions	
Headroom - Body	22, 23	Width	21
Heights	21	Length	21
Horns	15	Height	21
Horsepower - Brake	2	Ground Clearance	21
Ignition System	16	Front Compartment	22
Inflation - Tires	13	Rear Compartment	22
Interior Volumes	22	Luggage Compartment	22
Instruments	15	Station Wagon - Third Seat	23
Legroom	22, 23	Station Wagon - Cargo Space	23
Lengths	21	Hatchback - Cargo Space	23
Leveling, Suspension	11	Fiducial Marks	24
Lifters, Valve	4	Voltage Regulator	16
Linings - Clutch, Brake	8, 12	Water Pump	5
Lubrication - Engine Transmission / Transaxle	4, 8, 9	Weights	25, 26
Luggage Compartment	22	Wheel Alignment	15
Models	1	Wheelbase	21
Motor Starting	16	Wheels & Tires	13
Muffler	7	Wheel Spindle	14
Origin	1	Widths	1
		Windshield	1
		Windshield Wiper and Washer	15