

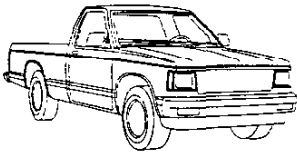

CONTENTS

	<u>Page</u>
MODELS	2
EL (X81) TRIM	3
S-10 STANDARD TRIM	4
TAHOE (YC2) TRIM	5
BAJA (5Z7) TRIM	6
POWERTRAINS	7
STANDARD SUSPENSION — TWO-WHEEL DRIVE MODELS	10
OPTIONAL SUSPENSION — TWO-WHEEL DRIVE MODELS	11
STANDARD SUSPENSION — FOUR-WHEEL DRIVE MODELS	12
OPTIONAL SUSPENSION — FOUR-WHEEL DRIVE MODELS	13
WHEELS AND TIRES	14
FRAME/STEERING/BRAKES	15
ELECTRICAL	16
COOLING	17
DIMENSIONS	18
OPTIONS	20
COLOR COMBINATIONS	23
EXTERIOR COLORS	B
INTERIOR TRIM	C
SEATS	D
TRAILERING	E

TWO-WHEEL DRIVE MODELS



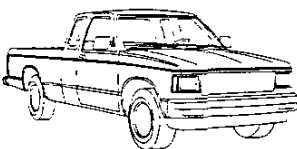

MODEL NUMBER	BOX (FT.)	GVWR (LBS.)	MAX' PAYLOAD (LBS.)	PASS. CAP. (STD/OPT)	STD ENGINE/ TRANS	OPT ENGINE/ TRANS
S-10 4X2 EL REGULAR CAB FLEETSIDE						
 CS10603/E63/X81	6	4200	1522	3/—	2.5L L4/M5	—
S-10 4X2 REGULAR CAB FLEETSIDE						
 CS10603/E63/X96	6	4200	1523	3/2	2.5L L4/M5	2.5L L4/A4 2.8L V6/M5 4.3L V6/A4/M5
CS10603/E63/X96/G51	6	4600	1915	3/2	2.5L L4/M5	2.5L L4/A4 2.8L V6/M5 4.3L V6/A4/M5
CS10803/E63	7.5	4200	1437	3/2	2.5L L4/M5	2.5L L4/A4 2.8L V6/M5 4.3L V6/A4/M5
CS10803/E63/G51	7.5	4600	1829	3/2	2.5L L4/M5	2.5L L4/A4 2.8L V6/M5
CS10803/E63/G51	7.5	4900	1918	3/2	4.3L V6/M5	4.3L V6/M4
S-10 4X2 EXTENDED CAB FLEETSIDE						
 CS10653/E63	6	4200	1387	3/2/4	2.5L L4/M5	2.5L L4/A4 2.8L V6/M5 4.3L V6/A4/M5
CS10653/E63/G51	6	4600	1779	3/2/4	2.5L L4/M5	2.5L L4/A4 2.8L V6/M5 4.3L V6/A4/M5

S-10 EL REGULAR CAB FLEETSIDE
The EL is an economy 2-wheel drive model for price-conscious buyers. It is only offered with a 6-foot cargo box and one trim level.

S-10 REGULAR CAB FLEETSIDE
The Regular Cab Fleetside is available with a 6-foot or 7.5-foot cargo box, three GVWRs and a variety of powertrains to meet the needs of today's compact truck buyer.

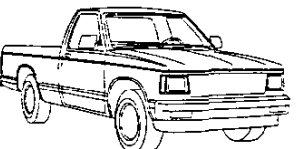
S-10 EXTENDED CAB FLEETSIDE
The Extended Cab Fleetside model offers a cab design with a generous amount of secure in-cab storage behind the front seat. Optional folding jump seats are available to accommodate two additional passengers.

FOUR-WHEEL DRIVE MODELS

MODEL NUMBER	BOX (FT.)	GVWR (LBS.)	MAX' PAYLOAD (LBS.)	PASS. CAP. (STD/OPT)	STD ENGINE/ TRANS	OPT ENGINE/ TRANS
S-10 4X4 REGULAR CAB FLEETSIDE						
 CT10603/E63	6	4650	1402	3/2	4.3L V6/M5	4.3L V6/A4
CT10603/E63/G51	6	5150	1894	3/2	4.3L V6/M5	4.3L V6/A4
CT10803/E63	7.5	4650	1355	3/2	4.3L V6/M5	4.3L V6/A4
CT10803/E63/G51	7.5	5150	1847	3/2	4.3L V6/M5	4.3L V6/A4
S-10 4X4 BAJA REGULAR CAB FLEETSIDE						
 CT10603/E63/SZ7	6	5150	1715	2/—	4.3L V6/M5	4.3L V6/A4
S-10 4X4 EXTENDED CAB FLEETSIDE						
 CT10653/E63	6	4650	1277	3/2/4	4.3L V6/M5	4.3L V6/A4
CT10653/E63/G51	6	5150	1769	3/2/4	4.3L V6/M5	4.3L V6/A4
S-10 4X4 BAJA EXTENDED CAB FLEETSIDE						
 CT10653/E63/SZ7	6	5150	1590	2/4	4.3L V6/M5	4.3L V6/A4

S-10 REGULAR CAB FLEETSIDE
The Regular Cab Fleetside adds the versatility of 4-wheel drive to the availability of a 6-foot or 7.5-foot cargo box, two GVWRs and a variety of powertrains to meet the needs of today's compact truck buyer.

S-10 BAJA REGULAR CAB FLEETSIDE
The Baja Regular Cab Fleetside is available with a rugged off-road appearance to meet the needs of today's 4-wheel drive sport-truck buyer.

S-10 EXTENDED CAB FLEETSIDE
The Extended Cab Fleetside model combines the versatility of 4-wheel drive with the secure in-cab storage and added passenger capacity of extended cab design.

S-10 BAJA EXTENDED CAB FLEETSIDE
The Baja Extended Cab Fleetside provides today's 4-wheel drive sport-truck buyer with secure in-cab storage and added passenger capacity with a rugged off-road appearance.

*Based on curb weight.

EL
(X81)

The EL is a decontented standard trim level designed to offer a price leader vehicle for the value-conscious truck buyer. The low sticker price reflects some omissions from the content of the Standard trim level. The EL is available as a 2-wheel drive regular cab model only.

The following features are standard.

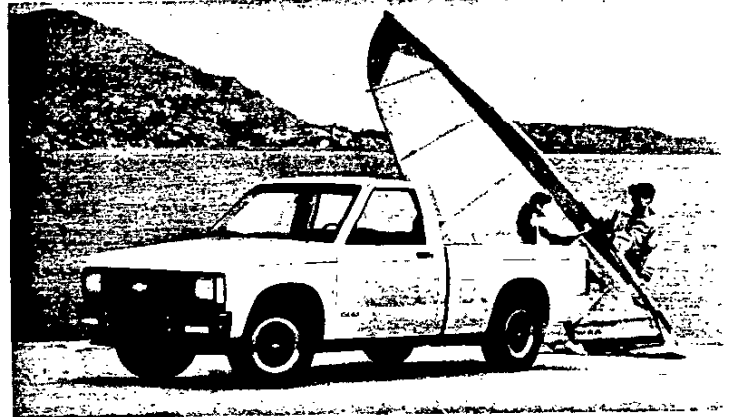

Some equipment shown may be optional or extra cost.

POWERTRAIN/CHASSIS

- ALTERNATOR: 96 amp Delcotron.
- BATTERY: 525 amp CCA.
- BRAKES: Power-assisted; front disc, rear drum. Includes rear-wheel anti-lock system.
- ENGINE: 2.5-liter L4 EFI. 105 net horsepower @ 4800 rpm and 135 lb. ft. of net torque @ 3200 rpm.

- EXHAUST: Single.
- FRAME: All-welded ladder-type, channel design and boxed front-end section.
- FUEL TANK: 13-gallon (approx.).
- REAR AXLE: Hypoid, Semi-Floating. Ratio: 3.73:1.
- SHOCK ABSORBERS: Front—25 mm. Rear—25 mm.

- STABILIZER BAR: Front—98 in.
- STEERING: Manual. Ratio: 28/24.1:1.
- SUSPENSION: Front—Independent with computer-selected coil springs. Rear—Semi-Elliptic two-stage multi-leaf springs.
- TRANSMISSION: 5-speed manual with overdrive.

EXTERIOR

- AIR DAM: Black.
- BUMPER: Black.
- COLORS: Choice of ten in a solid paint scheme. See Color and Trim specifications for details.
- GRILLE: Black plastic.

- HEADLAMPS: Single rectangular halogen.
- HORN: Single electric high-note.
- MIRRORS: Black RH and LH fixed with adjustable heads. Head size is 4.0" x 6.5".
- PICKUP BOX: All-welded, double wall construction and steel floor.

- SPARE TIRE/WHEEL: Compact tire and steel wheel.
- SPARE TIRE CARRIER: Winch-type mounted under frame at rear.
- TIRES: Four P195/75R14 BW all-season steel-belted radials.
- WHEELS: Four 14.0" x 6.0" steel painted argent. Includes bright metal hub covers.

INTERIOR

- ARMRESTS: RH and LH padded integral with door panels.
- CIGARETTE LIGHTER: Located on instrument panel.
- COAT HOOK: RH.
- COLORS: Choice of four—Blue, Garnet, Charcoal and Saddle.
- DOME LAMP: Switches in RH and LH door jambs.
- DOOR SILL PLATE: Black.

- FLOOR COVERING: Embossed black rubber mats.
- GAGES: Including speedometer, odometer, fuel level, voltmeter, temperature, oil pressure gages and additional telltale lights.
- GLOVE BOX: Includes locking door.
- HEADLINER: Color-keyed with partial roof coverage.
- HEATER: Deluxe with windshield and side window defoggers.
- MIRROR: 10-inch rearview.

- RADIO: Delete.
- SEATS: 3-passenger front bench seat with folding backrest in Custom Vinyl or Custom Cloth trim.
- STEERING WHEEL: 2-spoke black.
- SUNSHADES: Color-keyed vinyl RH and LH padded.
- TOOLS: Mechanical jack and wheel wrench located in storage compartment on floor behind front seat.

STANDARD

The Standard trim level is the base trim level for the S-10 Pickup. It is designed to offer truck buyers a high level of standard features when purchasing a base-level truck.

The following features are standard. Bold type denotes equipment that is in addition to or replaces that of the EL trim.

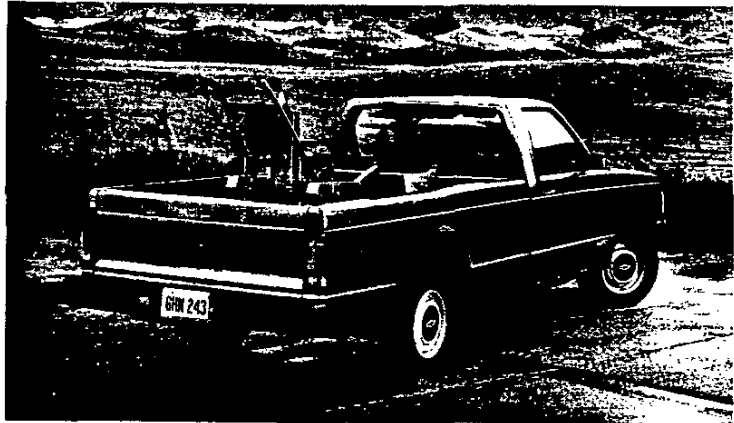

Some equipment shown may be optional or extra cost

POWERTRAIN/CHASSIS

- **ALTERNATOR:** 96 amp Delcotron on 2-wheel drives with 2.5-liter engine. 85 amp Delcotron on 4-wheel drives with 4.3-liter engine.
- **BATTERY:** 525 amp CCA.
- **BRAKES:** Power-assisted; front disc, rear drum. Includes rear-wheel anti-lock system that operates in 2-wheel drive only.
- **ENGINE:** 2.5-liter L4 EFI on 2-wheel drives. 105 net horsepower @ 4800 rpm and 135 lb. ft. of net torque @ 3200 rpm. 4.3-liter V6 EFI on 4-wheel drives. 160 net horsepower @ 4000 rpm and 230 lb. ft. of net torque @ 2800 rpm.
- **EXHAUST:** Single.
- **FRAME:** All-welded ladder-type, channel design and boxed front-end section.
- **FUEL TANK:** 20-gallon (approx.).
- **REAR AXLE:** Hypoid, Semi-Floating. Ratio: 3.73:1 on 2-wheel drives. 3.08:1 on 4-wheel drives.
- **SHOCK ABSORBERS:** Front—25 mm. Rear—25 mm.
- **STABILIZER BAR:** Front—.98 on 2-wheel drives. 1.10 on 4-wheel drives.
- **STEERING:** Manual on 2-wheel drive reg. cabs. Ratio: 28/24.1:1. Integral power on 2-wheel drive ext. cabs and 4-wheel drives. Ratio: 16/13:1.
- **SUSPENSION:** Front—Independent with computer-selected coil springs on 2-wheel drives and torsion bars on 4-wheel drives. Rear—Semi-Elliptic two-stage multi-leaf springs.
- **TOW HOOKS:** Front-mounted on 4-wheel drives.
- **TRANSMISSION:** 5-speed manual with overdrive.

EXTERIOR

- **AIR DAM:** Black.
- **BUMPER:** Black front. (A matching rear bumper is available as an option only).
- **COLORS:** Choice of ten in a solid paint scheme. See Color and Trim specifications for details.
- **GRILLE:** Molded plastic black.
- **HEADLAMPS:** Single rectangular halogen.
- **HORN:** Single electric high-note.
- **MIRRORS:** Black RH and LH fixed with adjustable heads. Head size is 4.0" x 6.5".
- **NAMEPLATE:** S10 on doors.
- **PICKUP BOX:** All-welded, double wall construction and steel floor.
- **SPARE TIRE/WHEEL:** Full-size.
- **SPARE TIRE CARRIER:** Winch-type mounted under frame at rear.
- **TIRES:** Four all-season steel-belted radials. P195/75R14 BW on 2-wheel drives and P205/75R15 BW on 4-wheel drives.
- **WHEELS:** Four 14.0" x 6.0" steel painted argent with bright metal hub covers on 2-wheel drives. 15" x 6.0" painted black on 4-wheel drives.

INTERIOR

- **ARMRESTS:** RH and LH padded integral with door panels.
- **CIGARETTE LIGHTER:** Located on instrument panel.
- **COAT HOOK:** RH. Ext. cabs have RH and LH coat hooks.
- **COLORS:** Choice of four—Blue, Garnet, Charcoal and Saddle.
- **DOVE LAMP:** Switches in RH and LH door jambs.
- **DOOR PANELS:** Two piece, two-toned plastic with map pockets.
- **DOOR SILL PLATE:** Black.
- **FLOOR COVERING:** Embossed black rubber mats.
- **GAGES:** Including speedometer, odometer, trip odometer, fuel level, voltmeter, temperature, oil pressure gages and additional telltale lights.
- **GLOVE BOX:** Includes locking door.
- **HEADLINER:** Color-keyed with partial roof coverage. Ext. cab models have full roof coverage.
- **HEATER:** Deluxe with windshield and side window defoggers.
- **INSULATION:** Provided on the dash panel, doors, roof and front floor. Ext. cabs have full floor insulation.
- **MIRRORS:** 10-inch rearview. RH visor mirror on ext. cab models.
- **RADIO:** Electronically-tuned AM with two 4" x 6" standard front dash speakers, digital clock and fixed mast antenna. (Refer to Delco Electronics brochure in RPO Detail for further information).
- **SEATS:** 3-passenger front bench with folding backrest and choice of Custom Vinyl or Custom Cloth.
- **STEERING WHEEL:** 2-spoke black. 4-wheel drives—deluxe black.
- **SUNSHADES:** Padded, color-keyed RH and LH.
- **TOOLS:** Mechanical jack and wheel wrench located in storage compartment on floor behind front seat.
- **WINDOWS:** Light tinted glass.

TAHOE

(YC2)

Tahoe trim level is an optional trim level for the S-10 Pickup. It is designed to offer truck buyers an increased level of comfort and convenience features compared to the Standard trim.

The following features are standard. Bold type denotes equipment in addition to or replacing that of the Standard trim.



Some equipment shown may be optional or extra cost.

POWERTRAIN/CHASSIS

- ALTERNATOR: 96 amp Delcotron on 2-wheel drives with 2.5-liter engine. 85 amp Delcotron on 4-wheel drives with 4.3-liter engine.
- BATTERY: 525 amp CCA.
- BRAKES: Power-assisted; front disc, rear drum. Includes rear-wheel anti-lock system that operates in 2-wheel drive only.
- ENGINE: 2.5-liter L4 EFI on 2-wheel drives. 105 net horsepower @ 4800 rpm and 135 lb. ft. of net torque @ 3200 rpm. 4.3-liter EFI on 4-wheel drives. 160 net horsepower @ 4000 rpm and 230 lb. ft. of net torque @ 2800 rpm.
- EXHAUST: Single.
- FRAME: All-welded ladder-type, channel design and boxed front-end section.
- FUEL TANK: 20-gallon (approx.).
- REAR AXLE: Hypoid, Semi-Floating. Ratio: 3.73:1 on 2-wheel drive s. 3.08:1 on 4-wheel drives.
- SHOCK ABSORBERS: Front—25 mm. Rear—25 mm.
- STABILIZER BAR: Front—.98 on 2-wheel drives. 1.10 on 4-wheel drives.
- STEERING: Manual on 2-wheel drive reg. cabs. Ratio: 28/24.1:1. Integral power on 2-wheel drive ext. cabs and 4-wheel drives. Ratio: 16/13:1.
- SUSPENSION: Front—Independent with computer-selected coil springs on 2-wheel drives and torsion bars on 4-wheel drives. Rear—Semi-Elliptic two-stage multi-leaf springs.
- TOW HOOKS: Front-mounted on 4-wheel drives.
- TRANSMISSION: 5-speed manual with overdrive.

EXTERIOR

- AIR DAM: Black.
- BODY SIDE MOLDINGS: **Black plastic with bright trim.**
- BUMPER: **Chrome front including a black rub strip.** (A matching rear bumper is available as an option only).
- COLORS: Choice of ten in a solid paint scheme. See Color and Trim specifications for details.
- GRILLE: **Chrome and dark gray.**
- HEADLAMPS: Single rectangular halogen.
- HORN: Single electric high-note.
- LAMP: **Engine compartment.**
- MIRRORS: Black RH and LH **below-eye-line** type. Head size is 6.0" x 7.0".
- MOLDINGS: **Bright wheel opening lip.**
- NAMEPLATE: **Tahoe.**
- PICKUP BOX: All-welded, double wall construction and steel floor.
- SPARE TIRE/WHEEL: Full-size
- SPARE TIRE CARRIER: Winch-type mounted under frame at rear.
- TIRES: Four all-season steel-belted radials. P195/75R14 BW on 2-wheel drives and P205/75R15 BW on 4-wheel drives.
- WHEELS: Four 14.0" x 6.0" **Rally with silver rims and trim rings on 2-wheel drives. Includes a black center insert with gold "bow tie". 15.0" x 6.0" black steel wheels with trim rings on 4-wheel drives.**
- WINDOWS: Ext. cabs have swing-out quarter windows.

INTERIOR

- ARMRESTS: RH and LH padded integral with door panels.
- CIGARETTE LIGHTER: Located on instrument panel. **Includes ash tray light.**
- COAT HOOK: RH. Ext. cabs have RH and LH.
- COLORS: Choice of four—Blue, Garnet, Charcoal and Saddle.
- DOME LAMP: Switches in RH and LH door jambs.
- DOOR PANELS: **Consists of special custom cloth upper inserts, carpeted lower insert and coin holder in LH door.**
- DOOR SILL PLATE: Black.
- FLOOR COVERING: **Color-keyed full floor carpeting.**
- GAGES: Including speedometer, odometer, trip odometer, fuel level, voltmeter, temperature, oil pressure gages and additional telltale lights.
- GLOVE BOX: Includes locking door.
- HEADLAMP WARNING BUZZER: **Headlamps on.**
- HEADLINER: Color-keyed with full roof coverage.
- HEATER: Deluxe with windshield and side window defoggers.
- INSULATION: Provided on the dash panel, doors, roof and front floor. Ext. cabs have full floor insulation. **Additional insulation is provided on the cab back, hood and cowl-to-fender seals.**
- MIRRORS: 10-inch rearview with dual reading lamps. RH visor mirror.
- RADIO: Electronically-tuned AM with two 4" x 6" standard front dash speakers, digital clock and fixed mast antenna. (Refer to Delco Electronics brochure in RPO Detail for further information).
- SEATS: 3-passenger front bench with folding backrest and choice of Custom Vinyl or Custom Cloth.
- STEERING WHEEL: **Deluxe black**
- SUNSHADES: Padded, color-keyed RH and LH.
- TOOLS: Mechanical jack and wheel wrench located in storage compartment on floor behind front seat.
- WINDOWS: Light tinted glass.

BAJA

(5Z7)

The Baja trim level is unique to pickup models with SE0 5Z7 Baja Appearance Package and requires Tahoe (YC2) trim. Baja Pickups are equipped as off-road sport vehicles and are available as 4-wheel drive models only.

The following features are standard. Bold type denotes equipment that is in addition to or replaces that of the Tahoe Trim.

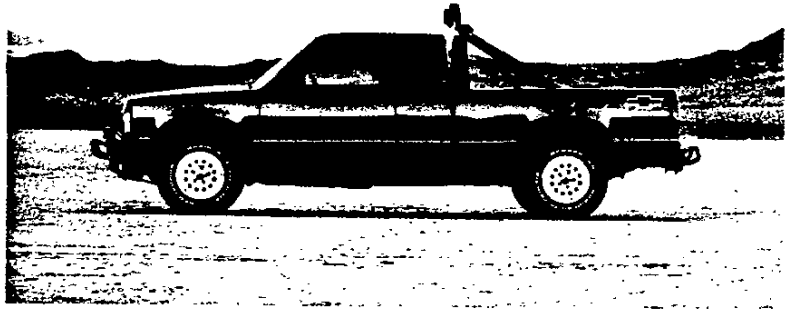

Some equipment shown may be optional or extra cost.

POWERTRAIN/CHASSIS

- ALTERNATOR: 100 amp Delcotron.
- BATTERY: 630 CCA.
- BRAKES: Power-assisted: front disc, rear drum.
- ENGINE: 4.3 liter V6 EFI, 160 net horsepower @ 4000 rpm and 230 lb. ft. of net torque @ 2800 rpm.
- EXHAUST: Single.
- FOUR-WHEEL DRIVE: Insta-Trac.
- FRAME: All-welded ladder type, channel design and boxed front-end section.
- FUEL TANK: 20 gallon (approx.)

- REAR AXLE: Hypoid, Semi-Floating. Ratio: 3.42:1.
- SHOCK ABSORBERS: Front—46 mm. Rear—46 mm.
- STABILIZER BAR: Front—.98 in.
- STEERING: Integral Power. Ratio: 16/13:1.
- SUSPENSION: Off-Road Package—Includes gas-filled shock absorbers, independent front suspension with upsized torsion bar, jounce bumpers

- and stabilizer bar and semi-elliptic two-stage rear multi-leaf springs.
- TOW HOOKS: Front-mounted.
- TRANSMISSION: 5-speed manual with overdrive.
- UNDERBODY SHIELD PACKAGE: includes transfer case and front differential skid plates, fuel tank and steering linkage plates.

EXTERIOR

- AIR DAM: Black.
- BUMPERS: Front and rear black double bar brush guard. Rear license plate mounting
- COLORS: Choice of Black, Red, or White solid paint scheme.
- DECALS: "Baja" in silver with black paint or black with red or white paint located on pickup box sides. Includes red "bow tie".
—"Chevrolet" windshield banner; silver with black paint, red with red paint or white with white paint.
—Red "bow tie" decal on hood.

—"Chevrolet" in shadow effect on tailgate; silver with black paint or black with red or white paint. A red "bow tie" is located to the left of the decal.

—A one-inch red stripe located on the body side and tailgate under tail lamp lens.

- FOG LAMPS: Located above front bumper.
- GRILLE: Molded black plastic, includes black decal stripe around top.
- HEADLAMPS: Single rectangular halogen.
- HORN: Single electric high-note.

- LIGHT BAR: Includes off-road lamps.
- MIRRORS: Black RH and LH exterior below-eye-line type. Head size is 6.0" x 7.0".
- MOLDINGS: Black wheel opening lip.
- PICKUP BOX: All-welded, double wall construction and steel floor.
- SPARE TIRE/WHEEL: Full size.
- TIRES: Four LT235/75R15 white lettered on-off road steel belted radials.
- WHEELS: Four 15.0" x 7.0" black steel with bright trim rings.

INTERIOR

- ARMREST: RH and LH padded; integral with door panels.
- CIGARETTE LIGHTER: Located on instrument panel. Includes ashtray light.
- COAT HOOKS: RH. Ext. cab model has RH and LH.
- COLORS: Charcoal only.
- CONSOLE: Center between bucket seats.
- DOME LAMP: Switches on RH and LH door jambs.
- DOOR PANELS: Charcoal and red sport cloth upper insert, carpeted lower insert, and coin holder in LH door.
- DOOR SILL PLATE: Black.
- FLOOR COVERING: Charcoal floor mats and full floor carpeting.

- GAGES: Includes speedometer, odometer, fuel level, voltmeter, temperature, and oil pressure gages and additional telltale lights.
- GLOVE BOX: Includes locking door and light.
- HEADLAMP WARNING BUZZER: Headlamps on.
- HEADLINER: Charcoal with full roof coverage.
- HEATER: Deluxe with windshield and side window defoggers.
- MIRRORS: 10-inch rearview and RH visor mirror.

- RADIO: Electronically-tuned AM with two 4" x 6" standard front dash speakers, digital clock and fixed mast antenna. (Refer to Delco Electronics brochure in RPO Detail for further information).
- SEATS: 2-passenger front high-back buckets in charcoal and red Sport Cloth with "Baja" embroidered on back cover below the headrest.
- STEERING WHEEL: Deluxe black.
- SUNSHADES: Charcoal vinyl RH and LH padded.
- TOOLS: Mechanical jack and wheel wrench located in storage compartment on floor behind front seat.
- WINDOWS: Lightly tinted glass.

KEY: S Standard O Optional — Not Offered Bold Print Not Available w/High Altitude Emissions.

MODEL	ENGINE	TRANSMISSION		AXLES					GVWR	
		MANUAL 5-SPEED (MM5)	AUTOMATIC 4-SPEED (MX0)	ECONOMY		POWER				
				2.73	3.08	3.42	3.73	4.11		
TWO-WHEEL DRIVE MODELS										
S-10 4X2 EL REGULAR CAB FLEETSIDE CS10603/E63/X81	2.5L L4 (L38)	S	—	—	—	—	S	—	4200	
S-10 4X2 REGULAR CAB FLEETSIDE CS10603/E63/X96	2.5L L4 (L38)	S	—	—	—	—	S	—	4200	
		—	O	—	—	—	S ¹	O ²	4600	
		S	—	—	—	—	S	—	4600	
		—	O	—	—	—	S ¹	O ²	4600	
	2.8L V6 (LL2)	S	—	—	—	—	S ¹	O ²	4200	
		S	—	—	—	—	S ¹	O ²	4600	
		4.3L V6 (LB4)	S ¹	—	S ¹	O	—	—	—	4200
			—	O	—	S ¹	O	—	—	4600
S-10 4X2 REGULAR CAB FLEETSIDE CS10803/E63	2.5L L4 (L38)	S	—	—	—	—	S ¹	O	4200	
		—	O	—	—	—	S ¹	O ²	4600	
		S	—	—	—	—	S	—	4600	
		—	O	—	—	—	S ¹	O ²	4600	
	2.8L V6 (LL2)	S	—	—	—	—	S ¹	O ²	4200	
		S	—	—	—	—	S ¹	O ²	4600	
		4.3L V6 (LB4)	S ¹	—	S ¹	O	—	—	—	4200
			—	O	—	S ¹	O	—	—	4900
S-10 4X2 EXTENDED CAB FLEETSIDE CS10653/E63	2.5L L4 (L38)	S	—	—	—	—	S ¹	O	4200	
		—	O	—	—	—	S ¹	O ²	4600	
		S	—	—	—	—	S	—	4600	
		—	O	—	—	—	S ¹	O ²	4600	
	2.8L V6 (LL2)	S	—	—	—	—	S ¹	O	4200/4600	
		4.3L V6 (LB4)	S	—	S ¹	O	—	—	4200/ 4600	
			—	O	—	S ¹	O	—	—	
		FOUR-WHEEL DRIVE MODELS								
S-10 4X4 REGULAR CAB FLEETSIDE CT10603/E63	4.3L V6 (LB4)	S ¹	—	—	S ¹	O ²	—	—	4650	
		—	O	—	S ¹	O ²	—	—	5150	
		S ¹	—	—	S ¹	O ²	—	—	5150	
		—	O	—	S ¹	O ²	—	—	5150	
S-10 4X4 REGULAR CAB FLEETSIDE CT10803/E63	4.3L V6 (LB4)	S ¹	—	—	S ¹	O ²	—	—	4650	
		—	O	—	S ¹	O ²	—	—	5150	
		S ¹	—	—	S ¹	O ²	—	—	5150	
		—	O	—	S ¹	O ²	—	—	5150	
S-10 4X4 BAJA REG. CAB FLEETSIDE CT10603/E63/5Z7	4.3L V6 (LB4)	S	—	—	S	—	—	5150		
		—	O	—	S	—	—	5150		
S-10 4X4 EXTENDED CAB FLEETSIDE CT10653/E63	4.3L V6 (LB4)	S ¹	—	—	S ¹	O ²	—	—	4650	
		—	O	—	S ¹	O ²	—	—	5150	
		S ¹	—	—	S ¹	O ²	—	—	5150	
		—	O	—	S ¹	O ²	—	—	5150	
S-10 4X4 BAJA EXT. CAB FLEETSIDE CT10653/E63/5Z7	4.3L V6 (LB4)	S	—	—	S	—	—	5150		
		—	O	—	S	—	—	5150		

¹N/A G80 Locking Differential. ²Standard Ratio with High Altitude Emissions.

HORSEPOWER AND TORQUE RATINGS

ENGINE	2.5L L4	2.8L V6	4.3L V6
RPO CODE	L38	LL2	LB4
CHART REFERENCE CODE	A	B	C
SAE NET HORSEPOWER Horsepower @ RPM	105 @ 4800	125 @ 4800	160 @ 4000
SAE NET TORQUE Lb. Ft. @ RPM	135 @ 3200	150 @ 2400	230 @ 2800
FUEL SYSTEM	EFI	EFI	EFI
CLUTCH SIZE in.	9.13	9.13	11.02
STD. BATTERY Cold Cranking Amps @ (0°F)	525	525	525

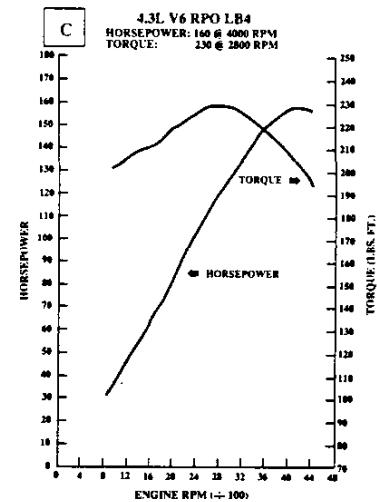
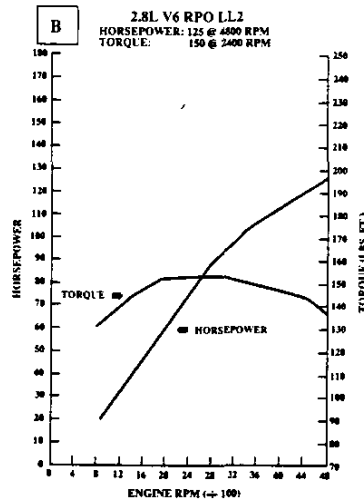
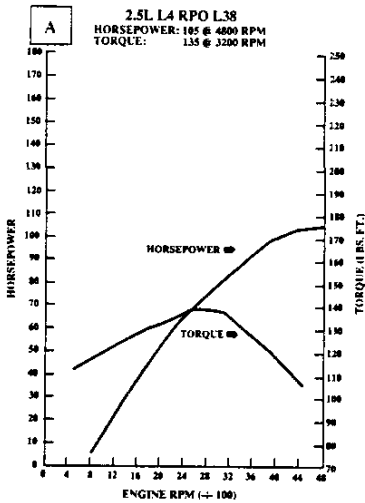

AXLES

REAR

FRONT—FOUR-WHEEL DRIVE

MAKE AND CAPACITY (lbs.)	GM 2700					GM 2700	
PINION & RING GEARS Type	Hypoid					Hypoid	
Ratio	2.73	3.08	3.42	3.73	4.11	3.08	3.42
Pinion Teeth	15	13	12	11	9	13	12
Ring Gear Teeth	41	40	41	41	37	40	4
Ring Gear Dia. (in.)	7.6	7.6	7.5/7.6 ¹	7.5	7.5	7.25	7.25
DIFFERENTIAL Type	2-Pinion Tapered Roller					2-Pinion Tapered Roller	
Bearings, Type							
AXLE SHAFTS Type	Semi-Floating Integral Shaft and Drive Flange 1.33					—	
Min. Diameter (in.)							
HOUSING @ SPRING SEAT Section Diameter and Thickness (in.)	2.69 x 0.116-0.175					—	
LUBRICANT CAPACITY (pints)	3.9					2.6	

¹4.3-liter engine requires 3.42 axle w/7.6" ring gear. 2.8-liter engine requires 3.42 axle w/7.5" ring gear.

TRANSMISSION		MANUAL			AUTOMATIC	
MODEL	MANUAL 5-SPEED w/ OVERDRIVE	MANUAL 5-SPEED w/ OVERDRIVE	MANUAL 5-SPEED w/ OVERDRIVE	AUTOMATIC 4-SPEED w/OVERDRIVE (4L60)		
ENGINE APPLICATION	2.5L L38	2.8L LL2	4.3L LB4	2.5L L38	4.3L LB4	
RPO CODE	MM5	MM5	MM5	MX0		
SYNCHRONIZED SPEEDS	1/2/3/4/5	1/2/3/4/5	1/2/3/4/5	—		
GEAR RATIOS						
First	4.03	3.76	4.02	3.06		
Second	2.37	2.18	2.32	1.63		
Third	1.49	1.42	1.40	1.00		
Fourth	1.00	1.00	1.00	.70		
Fifth	.86	.72	.83	—		
Reverse	3.76	3.76	3.74	2.29		
GEAR TYPE	—	—	—	Planetary		
Forward	Helical	Helical	Helical	—		
Reverse	Spur	Spur	Spur	—		
Center Distance (mm)	77	77	85	—		
TORQUE CONVERTER						
Element Types	—	—	—	Pump/Stator/Turbine		
Lock-up Clutch	—	—	—	Automatic		
LUBRICANT CAPACITY (pints)						
Oil	4.4	4.4	3.7	—		
Dry Fill	—	—	—	19		
Refill	—	—	—	10		

TRANSFER CASE	
MODEL	NEW PROCESS 231
AVAILABILITY	4-wheel drive
RATIOS	Hi Range 1.00:1 Lo Range 2.72:1
LEVER POSITIONS	4-Lo (All-wheel Underdrive) N (Neutral) 2-Hi (Rear-wheel Drive) 4-Hi (All-wheel Drive)
LEVER LOCATION	Rear of Transmission at Center of Floor
OIL CAPACITY (pints)	2.2

TWO-WHEEL DRIVE MODELS

MODEL	S-10 EL REGULAR CAB FLEETSIDE	S-10 REGULAR CAB FLEETSIDE	S-10 REGULAR CAB FLEETSIDE	S-10 EXTENDED CAB FLEETSIDE
MODEL NUMBER	CS10603/E63/ X81	CS10603/E63/ X96	CS10803/E63	CS10653/E63

STANDARD SUSPENSION

PAYLOAD Maximum (lbs.) ¹	1552	1523	1437	1387
GVWR (lbs.)	4200	4200	4200	4200
GAWR Front (lbs.) Rear (lbs.)	2500 2300	2500 2300	2500 2300	2500 2300
FRONT SUSPENSION Type Standard Spring Capacity Total (lbs.)	Independent Coil Spring 2500	Independent Coil Spring 2500	Independent Coil Spring 2500	Independent Coil Spring 2500
Front Shock Absorbers Piston Diameter (mm) Std/Opt	25/—	25/32	25/32	25/32
Front Stabilizer Bar Diameter (in.) Std/Opt	.98/—	.98/—	.98/—	.98/—
REAR SUSPENSION Type	Semi-Elliptic 2-Stage Multi-Leaf	Semi-Elliptic 2-Stage Multi-Leaf	Semi-Elliptic 2-Stage Multi-Leaf	Semi-Elliptic 2-Stage Multi-Leaf
Standard Spring Capacity Total (lbs.) Leaves Per Spring Leaf Total Thickness (in.)	2300 3 1.27	2300 3 1.27	2300 3 1.27	2300 3 1.27
Rear Shock Absorbers Piston Diameter (mm) Std/Opt	25/—	25/32	25/32	25/32
FRONT AXLE Type Make Maximum Capacity (lbs.) Standard Hub Locks Pinion/Ring Gear Type	Independent — 2500 — —	Independent — 2500 — —	Independent — 2500 — —	Independent — 2500 — —
REAR AXLE Type Make Maximum Capacity (lbs.) Pinion/Ring Gear Type	Semi-Floating GM 2700 Hypoid	Semi-Floating GM 2700 Hypoid	Semi-Floating GM 2700 Hypoid	Semi-Floating GM 2700 Hypoid
STANDARD TIRES Capacity (lbs.) each Front/Rear Inflation (psi) maximum Revolutions per mile @ 45 mph	Tubeless SBR P195/75R14 BW 1272 35 817	Tubeless SBR P195/75R14 BW 1272 35 817	Tubeless SBR P195/75R14 BW 1272 35 817	Tubeless SBR P195/75R14 BW 1272 35 817
WHEELS Size (in.) Front/Rear Capacity (lbs.) each Bolt Holes Bolt Circle Diameter. (in.) Offset (mm)	14 x 6.00 1393 5 4.75 0	14 x 6.00 1393 5 4.75 0	14 x 6.00 1393 5 4.75 0	14 x 6.00 1393 5 4.75 0

¹ Based on curb weight.

TWO-WHEEL DRIVE MODELS					
MODEL	S-10 EL REGULAR CAB FLEETSIDE	S-10 REGULAR CAB FLEETSIDE	S-10 REGULAR CAB FLEETSIDE		S-10 EXTENDED CAB FLEETSIDE
MODEL NUMBER	CS10603/E63/ X81	CS10603/E63 X96	CS10803/E63		CS10653/E63
OPTIONAL SUSPENSION					
OPTION	—	G51	G51	G51	G51
PAYLOAD Maximum (lbs.) ¹		1915	1829	1918	1779
GVWR (lbs.)	—	4600	4600	4900	4600
GAWR (lbs.) Front	—	2500	2500		2500
Rear	—	2700	2700		2700
FRONT SUSPENSION Type	—	Independent Coil Spring	Independent Coil Spring		Independent Coil Spring
Standard Spring Capacity Total (lbs.)	—	2500	2500		2500
Front Shock Absorbers Piston Diameter Std/Opt	—	25/32	25/32		25/32
Front Stabilizer Bar Diameter (in.) Std/Opt	—	.98/1.14	.98/1.14		.98/—
REAR SUSPENSION Type	—	Semi-Elliptic 2-Stage Multi-Leaf	Semi-Elliptic 2-Stage Multi-Leaf		Semi-Elliptic 2-Stage Multi-Leaf
Standard Spring Capacity Total (lbs.)	—	2700	2700		2700
Leaves Per Spring	—	4	4		4
Leaf Total Thickness (in.)	—	1.66	1.66		1.66
Rear Shock Absorbers Piston Diameter Std/Opt	—	25/32	25/32		25/32
FRONT AXLE Type	—	Independent	Independent		Independent
Make	—	GM	GM		GM
Maximum Capacity (lbs.)	—	2500	2500		2500
Standard Hub Locks	—	—	—		—
Pinion/Ring Gear Type	—	—	—		—
REAR AXLE Type	—	Semi-Floating	Semi-Floating		Semi-Floating
Make	—	GM	GM		GM
Maximum Capacity (lbs.)	—	2700	2700		2700
Pinion/Ring Gear Type	—	Hypoid	Hypoid		Hypoid.
STANDARD TIRES	—	Tubeless SBR P205/75R14 BW	Tubeless SBR P205/75R14 BW		Tubeless SBR P205/75R14 BW
Capacity (lbs.) each Front/Rear	—	1392	1392		1392
Inflation (psi) maximum	—	35	35		35
Revolutions per mile @ 45 mph	—	798	798		798
WHEELS Size (in.)	—	14 x 6.00	14 x 6.00		14 x 6.00
Capacity (lbs.) each	—	1393	1393		1393
Bolt Holes	—	5	5		5
Bolt Circle Dia. (in.)	—	4.75	4.75		4.75
Offset	—	0	0		0

¹ Based on Curb Weight.

FOUR-WHEEL DRIVE MODELS

MODEL	S-10 REGULAR CAB FLEETSIDE	S-10 REGULAR CAB FLEETSIDE	S-10 BAJA REGULAR CAB FLEETSIDE	S-10 EXTENDED CAB FLEETSIDE	S-10 BAJA EXTENDED CAB FLEETSIDE
MODEL NUMBER	CT10603/E63	CT10803/E63	CT10603/E63/ 5Z7	CT10653/E63	CT10653/E63/ 5Z7

STANDARD SUSPENSION

PAYLOAD Maximum (lbs.) ¹	1402	1355	1715	1277	1590
GVWR (lbs.)	4650	4650	5150	4650	5150
GAWR (lbs.) Front	2700	2700	2700	2700	2700
Rear	2300	2300	2700	2300	2700
FRONT SUSPENSION					
Type	Torsion Bar	Torsion Bar	Torsion Bar	Torsion Bar	Torsion Bar
Standard Spring Capacity Total (lbs.)	2700	2700	2700	2700	2700
Front Shock Absorbers Piston Diameter (mm) Std/Opt	25/32/46	25/32/46	46/—	25/32/46	46/—
Front Stabilizer Bar Diameter (in.) Std/Opt	1.10/.98	1.10/.98	.98/—	1.10/.98	.98/—
REAR SUSPENSION					
Type	Semi-Elliptic 2-Stage Multi-Leaf	Semi-Elliptic 2-Stage Multi-Leaf	Semi-Elliptic 2-Stage Multi-Leaf	Semi-Elliptic 2-Stage Multi-Leaf	Semi-Elliptic 2-Stage Multi-Leaf
Standard Spring Capacity Total (lbs.)	2300	2300	2700	2300	2700
Leaves Per Spring	4	4	4	4	4
Leaf Total Thickness (in.)	1.35	1.35	1.35	1.35	1.35
Rear Shock Absorbers Piston Diameter (mm) Std/Opt	25/32/46	25/32/46	46/—	25/32/46	46/—
FRONT AXLE					
Type	Independent	Independent	Independent	Independent	Independent
Make	GM	GM	GM	GM	GM
Maximum Capacity (lbs.)	2700	2700	2700	2700	2700
Standard Hub Locks	Central Locking Disconnect	Central Locking Disconnect	Central Locking Disconnect	Central Locking Disconnect	Central Locking Disconnect
Pinion/Ring Gear Type	Hypoid	Hypoid	Hypoid	Hypoid	Hypoid
REAR AXLE					
Type	Semi-Floating	Semi-Floating	Semi-Floating	Semi-Floating	Semi-Floating
Make	GM	GM	GM	GM	GM
Maximum Capacity (lbs.)	2700	2700	2700	2700	2700
Pinion/Ring Gear Type	Hypoid	Hypoid	Hypoid	Hypoid	Hypoid
STANDARD TIRES					
	Tubeless SBR P205/75R15 BW	Tubeless SBR P205/75R15 BW	Tubeless SBR LT235/75R15 BW	Tubeless SBR P205/75R15 BW	Tubeless SBR LT235/75R15 BW
Capacity (lbs.) each Front/Rear	1453	1453	1985	1453	1985
Inflation (psi) maximum	35	35	50	35	50
Revolutions per mile @ 45 mph	769	769	723	769	723
WHEELS					
Size (in.) Front/Rear	15 x 6.00	15 x 6.00	15 x 7.00	15 x 6.00	15 x 7.00
Capacity (lbs.) each	1453	1453	1453	1453	1453
Bolt Holes	5	5	5	5	5
Bolt Circle Dia. (in.)	4.75	4.75	4.75	4.75	4.75
Offset (mm)	50	50	50	50	50

¹ Based on curb weight.

FOUR-WHEEL DRIVE MODELS					
MODEL	S-10 REGULAR CAB FLEETSIDE	S-10 REGULAR CAB FLEETSIDE	S-10 BAJA REGULAR CAB FLEETSIDE	S-10 EXTENDED CAB FLEETSIDE	S-10 BAJA EXTENDED CAB FLEETSIDE
MODEL NUMBER	CT10603/E63	CT10803/E63	CT10603/E63/ 527	CT10653/E63	CT10653/E63/ 527
OPTIONAL SUSPENSION					
OPTION	G51	G51	—	G51	—
PAYLOAD Maximum (lbs.) ¹	1894	1847	—	1769	—
GVWR (lbs.)	5150	5150	—	5150	—
GAWR (lbs.) Front	2700	2700	—	2700	—
Rear	2700	2700	—	2700	—
FRONT SUSPENSION					
Type	Torsion Bar	Torsion Bar	—	Torsion Bar	—
Standard Spring Capacity Total (lbs.)	2700	2700	—	2700	—
Front Shock Absorbers Piston Diameter (mm) Std/Opt	25/32/46	25/32/46	—	32/46	—
Front Stabilizer Bar Diameter (in.) Std/Opt	1.10/.98	1.10/.98	—	1.10/.98	—
REAR SUSPENSION					
Type	Semi-Elliptic 2-Stage Multi-Leaf	Semi-Elliptic 2-Stage Multi-Leaf	—	Semi-Elliptic 2-Stage Multi-Leaf	—
Standard Spring Capacity Total (lbs.)	2700	2700	—	2700	—
Leaves Per Spring	4	4	—	4	—
Leaf Total Thickness (in.)	1.48	1.48	—	1.48	—
Rear Shock Absorbers Piston Diameter (mm) Std/Opt	25/32/46	25/32/46	—	32/46	—
FRONT AXLE					
Type	Independent	Independent	—	Independent	—
Make	GM	GM	—	GM	—
Maximum Capacity (lbs.)	2700	2700	—	2700	—
Standard Hub Locks	Central Locking Disconnect	Central Locking Disconnect	—	Central Locking Disconnect	—
Pinion/Ring Gear Type	Hypoid	Hypoid	—	Hypoid	—
REAR AXLE					
Type	Semi-Floating	Semi-Floating	—	Semi-Floating	—
Make	GM	GM	—	GM	—
Maximum Capacity (lbs.)	2700	2700	—	2700	—
Pinion/Ring Gear Type	Hypoid	Hypoid	—	Hypoid	—
STANDARD TIRES					
Type	Tubeless SBR P205/75R15 BW	Tubeless SBR P205/75R15 BW	—	Tubeless SBR P205/75R15 BW	—
Capacity (lbs.) each Front/Rear	1453	1453	—	1453	—
Inflation (psi) maximum	35	35	—	35	—
Revolutions per mile @ 45 mph	769	769	—	769	—
WHEELS					
Size (in.) Front/Rear	15 x 6.00	15 x 6.00	—	15 x 6.00	—
Capacity (lbs.) each	1453	1453	—	1453	—
Bolt Holes	5	5	—	5	—
Bolt Circle Dia. (in.)	4.75	4.75	—	4.75	—
Offset (mm)	50	50	—	50	—

¹ Based on curb weight.

N/A - Not Available
AS - All-Season
SBR - Steel-Belted Radial Ply
BW - Blackwall
WL - White Lettered
HWY - Highway
ON-OFF - On-Off Road

TWO-WHEEL DRIVE MODELS

TIRES

SIZE	TYPE	RPO	CONDITION	PLY	LOAD RANGE	CAPACITY (lbs.) ea.	INFLATION (psi) max.	REV. PER MILE @ 45 mph
P195/75R14	AS SBR BW	QMW	STD	1	B	1272	35	817
P205/75R14	AS SBR BW	QFT	OPT (N/A on EL)	1	B	1392	35	798
P205/75R14	AS SBR WL	QSA	OPT (N/A on EL)	1	B	1392	35	798
P215/65R15	HWY SBR WL	QPP	OPT (N/A on EL)	2 Poly 2 Stl. 1 Nyl.	B	1372	35	801

WHEELS¹

SIZE (in.)	TYPE	RPO	TRIM LEVEL	BOLT HOLES	BOLT CIRCLE dia. (in.)	CAPACITY (lbs.) ea.	OFFSET (mm.)
14.0 X 6.0	STEEL (Painted argent)	—	Standard and EL (N/A w/QPP Tires)	5	4.75	1393	0
14.0 x 6.0	RALLY (Painted black and silver)	—	Tahoe (N/A w/QPP Tires)	5	4.75	1393	0
14.0 x 6.0	RALLY (Painted black and silver)	ZJ7	OPT on Standard and EL (N/A w/QPP Tires)	5	4.75	1393	0
15.0 x 7.0	RALLY (Painted black and silver)	—	Incl. when QPP tires are ordered. Available on Standard and Tahoe	5	4.75	1453	-6.4

FOUR-WHEEL DRIVE MODELS

TIRES

SIZE	TYPE	RPO	CONDITION	PLY	LOAD RANGE	CAPACITY (lbs.) ea.	INFLATION (psi) max.	REV. PER MILE @ 45 mph
P205/75R15	AS SBR BW	QCE	STD (N/A on Baja Models)	1	B	1453	35	769
P205/75R15	AS SBR WL	QCF	OPT (N/A on Baja Models)	1	B	1453	35	769
P205/75R15	ON-OFF SBR BL	QJT	OPT (N/A on Baja Models)	2 Poly. 2 Stl.	B	1453	35	760
P205/75R15	ON-OFF SBR WL	QJL	OPT (N/A on Baja Models)	2 Poly. 2 Stl.	B	1453	35	760
P235/75R15	ON-OFF SBR WL	QEB	OPT (N/A on Baja Models)	2 Poly. 2 Stl.	B	1843	35	716
LT235/75R15	ON-OFF SBR WL	QBE	STD on Baja Models Only	3 Poly. 2 Stl.	C	1985	50	723

WHEELS¹

SIZE (in.)	TYPE	RPO	TRIM LEVEL	BOLT HOLES	BOLT CIRCLE dia. (in.)	CAPACITY (lbs.) ea.	OFFSET (mm.)
15.0 x 6.0	STEEL ¹ (Painted silver)	—	Standard Tahoe (N/A w/QEB or QBE Tires or on Baja Models)	5	4.75	1453	50
15.0 x 7.0	STEEL ¹ (Painted silver)	—	Baja Models Only	5	4.75	1453	50
15.0 x 7.0	CAST ¹ ALUMINUM	N90	OPT (N/A w/QBE Tires or on Baja Models)	5	4.75	1453	50
15.0 X 7.0	CAST ² ALUMINUM	5P2	OPT (Baja Models Only)	5	4.75	1453	50

¹Steel Spare Wheel. ²Steel Spare Wheel Except When Box Mount 5P3 Spare Tire Carrier is Ordered which Includes an Aluminum Spare Wheel.

TWO-WHEEL DRIVE				FOUR-WHEEL DRIVE		
MODEL	S-10 EL/ STANDARD REGULAR CAB FLEETSIDE	S-10 REGULAR CAB FLEETSIDE	S-10 EXTENDED CAB FLEETSIDE	S-10 STANDARD/ BAJA REGULAR CAB FLEETSIDE	S-10 REGULAR CAB FLEETSIDE	S-10 STANDARD/ BAJA EXTENDED CAB FLEETSIDE
MODEL NUMBER	CS10603/E63/X81	CS10803/E63	CS10653/E63	CT10603/E63	CT10803/E63	CT10653/E63
	CS10603/E63/X96			CT10603/E63/SZ7		CT10653/E63/SZ7
FRAME						
Side Rail Dimensions Width (in.)	2.34	2.34	2.34	2.34	2.34	2.34
Depth (in.)	5.16	5.16	5.16	6.50	6.50	6.50
Thickness (in.)	.118	.134	.134	.118	.134	.134
Section Modulus Rails only	1.94	2.19	2.19	2.56	2.91	2.91
RBM of Frame	75,660	85,410	85,410	99,840	113,490	113,490
Width Over Rails Front (in.)	30.9	30.9	30.9	30.9	30.9	30.9
Rear (in.)	40.35	40.35	40.35	40.35	40.35	40.35
Overall Length of Rail (in.)	170.31	186.26	184.96	170.31	186.26	184.46
STEERING						
Type	Manual; Recirculating Ball Gear	Manual; Recirculating Ball Gear	Variable Ratio Integral Power	Variable Ratio Integral Power	Variable Ratio Integral Power	Variable Ratio Integral Power
Steering Ratio On Center/At Lock Opt: Variable Ratio Integral Power	28/24.1:1 17.5:1 ¹	28/24.1:1 17.5:1 ¹	15/13:1 —	16/13:1 —	16/13:1 —	16/13:1 —
Turning Diameter Curb-To-Curb (ft.) Wall-To-Wall (ft.)	36.8 38.7	39.7 41.5	41.1 43.0	37.7 39.4	40.5 42.3	42.1 43.8
BRAKES						
GVWR (lbs.)	4200 4200/4600	4200/4600/ 4900	4200/ 4600	4650/ 5150	4650/ 5150	4650/ 5150
Type	Vac. Power Front Disc Rear Drum w/Rear Wheel Anti-Lock System	Vac. Power Front Disc Rear Drum w/Rear Wheel Anti-Lock System	Vac. Power Front Disc Rear Drum w/Rear Wheel Anti-Lock System	Vac. Power Front Disc Rear Drum w/Rear Wheel Anti-Lock System	Vac. Power Front Disc Rear Drum w/Rear Wheel Anti-Lock System	Vac. Power Front Disc Rear Drum w/Rear Wheel Anti-Lock System
Booster Diaphragm Diameter (in.)	9.4 Single/ See Footnote ²	See Footnote ²	See Footnote ²	9.4 x 7.9 Tandem	9.4 x 7.9 Tandem	9.4 x 7.9 Tandem
Front Rotor Size Diameter x Thickness (in.)	10.5 x 1.03	10.5 x 1.03	10.5 x 1.03	10.5 x 1.03	10.5 x 1.03	10.5 x 1.03
Front Facing Contact Per Axle (sq. in.)	31.68	31.68	31.68	31.68	31.68	31.68
Rear Drum Size Diameter x Width (in.)	9.5 x 2.0	9.5 x 2.0	9.5 x 2.0	9.5 x 2.0	9.5 x 2.0	9.5 x 2.0
Rear Facing Contact Per Axle (sq. in.)	63.73	63.73	63.73	63.73	63.73	63.73
Parking Brake Type	Cable To Rear Wheels	Cable To Rear Wheels	Cable To Rear Wheels	Cable To Rear Wheels	Cable To Rear Wheels	Cable To Rear Wheels

¹Z08 Sport Chassis Pkg. has 15/13:1 steering ratio.
²9.4-inch single booster with the 2.5L L38 engine at 4200 GVWR.
 7.9-inch x 7.9-inch tandem booster at 4600 GVWR with 2.5L engine, and 4200/4600 GVWR with 2.8L engine.
 9.4-inch x 7.9-inch tandem booster with 4.3L LB4 engine.

TWO-WHEEL DRIVE

FOUR-WHEEL DRIVE

MODEL	S-10 EL REGULAR CAB FLEETSIDE	S-10 REGULAR CAB FLEETSIDE	S-10 EXTENDED CAB FLEETSIDE	S-10 REGULAR CAB/ EXTENDED CAB FLEETSIDE	S-10 BAJA REGULAR CAB FLEETSIDE/ EXTENDED CAB FLEETSIDE
MODEL NUMBER	CS10603/E63/X81	CS10603/E63/X96 CS10803/E63	CS10653/E63	CT10603/E63 CT10653/E63 CT10803/E63	CT10603/E63/5Z7 CT10653/E63/5Z7

ELECTRICAL

ENGINE	2.5L	2.5L	2.8L/ 4.3L ¹	2.5L	2.8L/ 4.3L ¹	4.3L	4.3L
STANDARD BATTERY Cold Cranking Amps @ 0°F @ -20°F Reserve Capacity Minutes @ 80°F	525 390 90	525 390 90	525 390 90	525 390 90	525 390 90	525 390 90	630 470 115
OPTIONAL BATTERY Cold Cranking Amps @ 0°F @ -20°F Reserve Capacity Minutes @ 80°F	— — —	UA1 630 470 115	UA1 630 470 115	UA1 630 470 115	UA1 630 470 115	UA1 630 470 115	— — —
STANDARD ALTERNATOR Max. Capacity (Amps) Max. Watts @ 12 Volts Nominal Amp @ Idle approx. Drive Pulley Ratio Model Number	96 1152 26 2.7:1 CS130	96 1152 26 2.7:1 CS130	85 1020 30 2.7:1 ¹ CS130	96 1152 26 2.7:1 CS130	85 1020 30 2.7:1 ¹ CS130	85 1020 30 3.2:1 CS130	100 1200 36 3.2:1 CS130

¹4.3L engine with the 85 amp alternator has a 3.2:1 drive pulley ratio.

ALTERNATOR CURVES

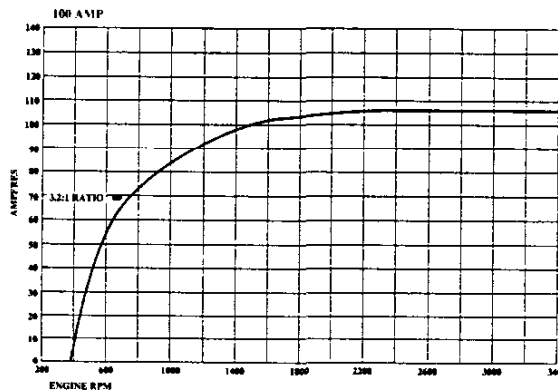
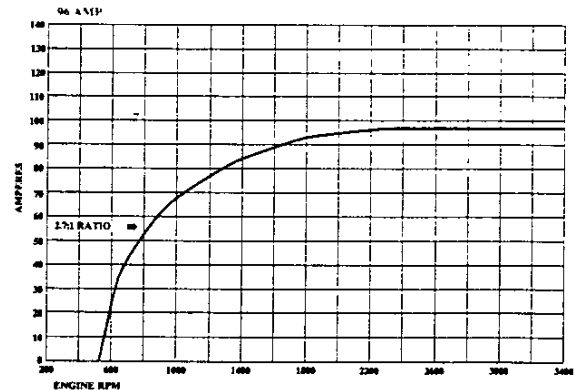
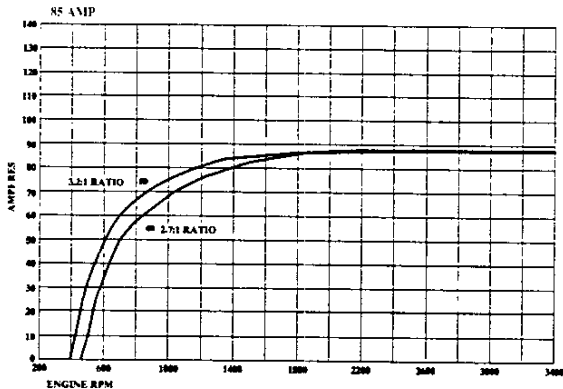

KEY: Regular Type—Manual and Automatic Transmission Red Type —Manual Transmission Only Bold Type —Automatic Transmission only

TWO-WHEEL AND FOUR-WHEEL DRIVE MODELS			
MODEL	S-10 4 X 2 EL REGULAR CAB FLEETSIDE	S-10 4 X 2 REGULAR CAB/EXTENDED CAB FLEETSIDE	S-10 4 X 4 STANDARD/BAJA EXT. CAB FLEETSIDE
MODEL NUMBER	CS10603/E63/X81	CS10603/E63/X96 CS10803/E63 CS10653/E63	CT10603/E63-CT10803/E63 CT10653/E63 CT10603/E63/5Z7 CT10653/E63/5Z7

STANDARD COOLING SYSTEM

ENGINE	2.5L	2.5L	2.8L	4.3L	4.3L
Radiator Thickness (in.)	.98	.98	.98	.93	.93
Total System Capacity (gal.)	3.0	2.9	3.0	3.0	3.0
Fan—No. Blades x Diameter x Pitch (in.)	5 x 15 x 2.05	5 x 15 x 2.05	5 x 15 x 2.05	3 x 18 x 2.0	3 x 18 x 2.0

OPTIONAL COOLING SYSTEMS

ENGINE	2.5L	2.5L	2.8L	4.3L	4.3L
AUTOMATIC TRANS.	—	MX0	—	MX0	MX0
Radiator Thickness (in.)	—	.98	—	.93	.93
Total System Capacity (gal.)	—	2.9	—	3.0	3.0
Fan—No. Blades x Diameter x Pitch (in.)	—	5 x 15 x 2.05	—	3 x 18 x 2.0	3 x 18 x 2.0
OPT. H.D. RADIATOR	V01	V01	—	V01	V01
Radiator Thickness (in.)	.98	.98	—	.93	.93
Total System Capacity (gal.)	3.0	3.0	—	3.0	3.0
Fan—No. Blades x Diameter x Pitch (in.)	5 x 15 x 2.05	5 x 15 x 2.05	—	3 x 18 x 2.0	3 x 18 x 2.0
OPT. AIR CONDITIONING	C60	C60	C60	C60	C60
Radiator Thickness (in.)	.98	.98	.98	.93	.93
Total System Capacity (gal.)	3.0	3.0	2.9	3.0	3.0
Fan—No. Blades x Diameter x Pitch (in.)	5 x 16.9/15 ¹ x 2.81	5 x 16.9/15 ¹ x 2.81	5 x 16 x 2.83	5 x 19 x 2.8	5 x 19 x 2.8
OPT. ENG. OIL COOLER	—	—	—	KC4	KC4
Radiator Thickness (in.)	—	—	—	.93	.93
Total System Capacity (gal.)	—	—	—	2.9	2.9
Fan—No. Blades x Diameter x Pitch (in.)	—	—	—	3 x 18 x 2.0	3 x 18 x 2.0
OPT. H.D. RADIATOR AND TRANS. OIL COOLER	—	—	—	V02	V02
Radiator Thickness (in.)	—	—	—	1.34	1.34
Total System Capacity (gal.)	—	—	—	3.0	3.0
Fan—No. Blades x Diameter x Pitch (in.)	—	—	—	3 x 18 x 2.0	3 x 18 x 2.0
OPT. H.D. RADIATOR AND TRANS. OIL COOLER AND ENGINE OIL COOLER	—	—	—	V02 & KC4	V02 & KC4
Radiator thickness (in.)	—	—	—	1.34	1.34
Total System Cap. (gal.)	—	—	—	2.9	2.9
Fan—No. Blades x Diameter x Pitch (in.)	—	—	—	3 x 18 x 2.0	3 x 18 x 2.0

¹ Variable Diameter

TWO-WHEEL DRIVE

FOUR-WHEEL DRIVE

MODEL	S-10 EL REG. CAB FLEETSIDE	S-10 REG. CAB FLEETSIDE	S-10 REG. CAB FLEETSIDE	S-10 EXT. CAB FLEETSIDE	S-10 STD/BAJA REG. CAB FLEETSIDE	S-10 REG. CAB FLEETSIDE	S-10 STD/BAJA EXT. CAB FLEETSIDE
MODEL NUMBER	CS10603/E63/X81	CS10603/E63/X96	CS10803/E63	CS10653/E63	CT10603/E63 CT10603/E63/5Z7	CT10803/E63	CT10653/E63 CT10653/E63/5Z7

EXTERIOR DIMENSIONS

BODY								
Wheelbase (in.)	WB	108.3	108.3	117.9	122.9	108.3	117.9	122.9
Overall Length (in.)	OAL	178.2	178.2	194.2	192.8	178.2/194.5	194.2	192.8/209.1
Overall Height (in.)	OAH	61.6	61.6	61.6	63.5	63.5/72.1 ¹	63.5	63.5/72.1 ¹
Maximum Width (in.)	OAW	64.7	64.7	64.7	64.7	64.7	64.7	64.7
Bumper to Axle Front (in.)	BA	30.6	30.6	30.6	30.6	30.6/38.1	30.6	30.6/38.1
Rear (in.)		39.3	39.3	39.3	39.3	39.3/48.1	45.6	39.3/48.1
Cab Axle (in.)	CA	38.6	38.6	48.3	38.6	38.6	48.3	38.6
Cab To End of Frame (in.)	—	74.2	74.2	90.1	74.2	74.2	90.1	74.2
Bumper To Back of Cab (in.)	BBC	100.2	100.2	100.2	114.8	100.2/107.5	100.2	114.8/122.1
Ground To Top of Rear Load Floor (in.)	GF	28.3	28.3	28.1	28.0	29.6	28.1	29.3
Ground Clearance								
Front (in.)	—	7.0	7.0	7.0	7.0	7.8/8.7	7.8	8.7/7.8
Rear (in.)		6.8	6.8	6.8	6.8	8.1/9.0	8.1	9.0/8.1
CARGO BOX								
Length (in.)	IBL	73.1	73.1	89.0	73.1	73.1	89.0	73.1
Inside Width at Top (in.)	IWT	55.3	55.3	55.3	55.3	55.3	55.3	55.3
Inside Width at Floor (in.)	IWF	59.1	59.1	59.1	59.1	59.1	59.1	59.1
Inside Width at Wheelhousing (in.)	IWW	40.3	40.3	40.3	40.3	40.3	40.3	40.3
Inside Height (in.)	—	15.9	15.9	15.9	15.9	15.9	15.9	15.9
Tailgate Width (in.)	—	53.6	53.6	53.6	53.6	53.6	53.6	53.6
SIGN PANEL AREA (in.)	Shaded Area	12 ³ / ₄ x45	12 ³ / ₄ x45	12 ³ / ₄ x45	12 ³ / ₄ x64	12 ³ / ₄ x45	12 ³ / ₄ x45	12 ³ / ₄ x64

¹To top of light bar.

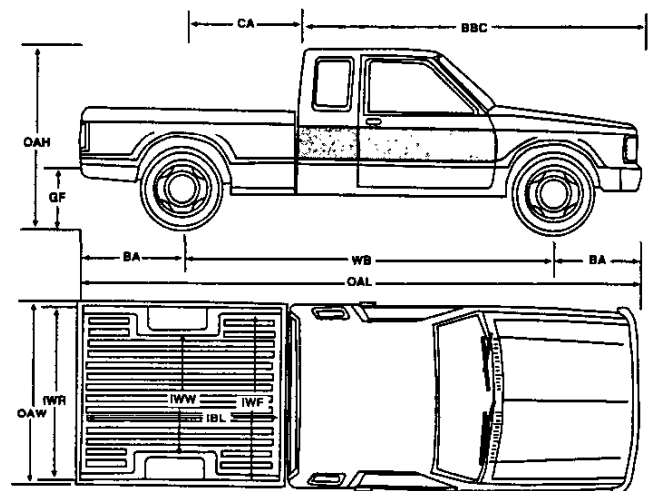
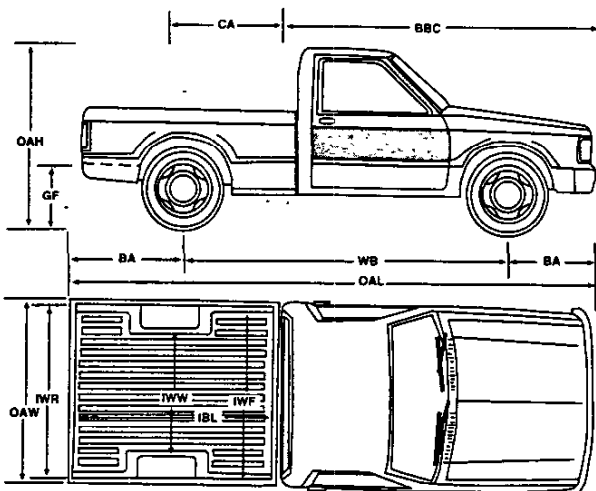

		TWO-WHEEL DRIVE				FOUR-WHEEL DRIVE		
MODEL		S-10 EL REG. CAB FLEETSIDE	S-10 REG. CAB FLEETSIDE	S-10 REG. CAB FLEETSIDE	S-10 EXT. CAB FLEETSIDE	S-10 STD/BAJA REG. CAB FLEETSIDE	S-10 REG. CAB FLEETSIDE	S-10 STD/BAJA EXT. CAB FLEETSIDE
MODEL NUMBER		CS10603/E63/X81	CS10603/E63/X96	CS10603/E63	CS10653/E63	CT10603/E63 CT10603/E63/5Z7	CT10803/E63	CT10653/E63 CT10653/E63/5Z7
INTERIOR DIMENSIONS								
CAB								
Headroom (in.)	HR	39.1	39.1	39.1	39.1	39.1	39.1	39.1
Legroom (in.)	LR	42.5	42.5	42.5	42.5	42.5	42.5	42.5
Shoulder Room (in.)	SR	54.2	54.2	54.2	54.2	54.2	54.2	54.2
Extended Cab Interior Volume w/and w/out Jump Seat (cu. ft.)	CV	—	—	—	13.7/18.3	—	—	13.7/18.3
FUEL TANK								
Std./Opt. Tank Nominal (gal.) approx.		13.0/20.0	20.0/—	20.0/—	20.0/—	20.0/—	20.0/—	20.0/—
Location of Tank		Inboard LH Frame Rail	Inboard LH Frame Rail	Inboard LH Frame Rail	Inboard LH Frame Rail	Inboard LH Frame Rail	Inboard LH Frame Rail	Inboard LH Frame Rail
Location of Filler		Left Side	Left Side	Left Side	Left Side	Left Side	Left Side	Left Side

Y: S - Standard
O - Optional
— Not Available

1. S-10 EL 4X2 REG. CAB (CS10603/E63/X81)
2. S-10 4X2 REG. CAB (CS10603/E63/X96)
3. S-10 4X2 REG. CAB (CS10803/E63)
4. S-10 4X2 EXT. CAB (CS10653/E63)
5. S-10 4X4 REG. CAB (CT10603/E63)

6. S-10 4X4 REG. CAB (CT10803/E63)
7. S-10 BAJA 4X4 REG. CAB (CT10603/E63/SZ7)
8. S-10 4X4 EXT. CAB (CT10653/E63)
9. S-10 BAJA 4X4 EXT. CAB (CT10653/E63/SZ7)

NOTE: Refer to Dealer Order Guide for Updated Option Availability.

OPTION	CODE	DESCRIPTION	RESTRICTION	MODELS				
				2-WHEEL DRIVE		4-WHEEL DRIVE		
				1	3	5	7	9
AIR CONDITIONING	C60		w/L38 Engine Incls V01 Cooling w/LB4 Engine Incls V01 Cooling w/o KC4 or V02 Cooling	O	O	O	O	O
AIR DAM WITH FOG LAMPS	ANL	Switch on Cluster		—	O	—	—	—
AXLE, REAR	G80	Locking Differential	Avail on Opt ratio only except where only one ratio is available	—	O	O	O	O
BATTERY	UA1	Heavy-Duty, 630 Cold Cranking Amps Delco Freedom; Included w/V10 Cold Climate		—	O	O	S	S
BUMPER EQUIPMENT Rear Step	VF6	Chrome Bumper w/YC2 Tahoe or ZY3 Paint; Black Bumper w/o YC2 Tahoe		—	O	O	—	—
CARRIER, SPARE TIRE	5P3	Mounted in Pickup Box	Reqs Baja SEO 5Z7	—	—	—	O	O
COLD CLIMATE PACKAGE	V10	Incls UA1 Battery, Engine Block Heater, Anti-Freeze, Protection to -32° F, Full Dash, Door Insulation Hood Blanket, Extra Floor Insulation and Backlite Moldings; Also Incls B30 Carpeting w/o YC2 Tahoe	B30 Carpeting	—	O	O	O	O
CONSOLE	D55	Incl w/YC2 Tahoe	Reqs High-Back Bucket	—	O	O	S	S
COOLING SYSTEM H.D. Engine Oil Cooler	KC4		Reqs LB4 Eng; N/A V01 Cooling	—	O	O	O	O
H.D. Radiator	V01	Incl w/C60 Air	N/A V02 Cooling or LL2 Eng or KC4 Cooling; S-10 2-wheel drive reqs L38/LB4; S-10 4-wheel drive reqs LB4 eng	—	O	O	O	O
Radiator and Transmission Oil Cooler	V02		Reqs LB4 Eng and MX0 Trans	—	O	O	O	O
CONVENIENCE PACKAGE Driver's	ZM7	Incls Comfortilt Steering and Intermittent Wipers		—	O	O	O	O
Operating	ZQ2	Incls Power Door Locks and Power Windows		—	O	O	O	O
ENDGATE, NET	5P4	Lockable, w/Corner Braces	Reqs Baja SEO 5Z7	—	—	—	O	O
ENGINES		(See Powertrains for Details)						
2.5-liter L4 EFI	L38		S-10 2-wheel drive only	S	S	—	—	—
2.8-liter V6 EFI	LL2		S-10 2-wheel drive only; reqs N40 Steering	—	O	—	—	—
4.3-liter V6 EFI	LB4		S-10 2-wheel drive reqs N40 Steering	—	O	S	S	S
FLOOR COVERING Floor Carpeting	B30	Full Floor	N/A YC2 Tahoe; Incl w/V10 Cold Climate	—	O	O	—	—
Mats, Removable	B32		Avail. Std S-10; Incl w/YC2 Tahoe	—	O	O	O	O
GAGES, ELECTRONIC	U52	Electronic Readout Voltmeter, Temperature, Oil Pressure, Fuel, Speedometer, Tachometer	N/A L38 Engine	—	O	O	O	O

OPTIONS

1991
S-10 PICKUP

- KEY S - Standard
O - Optional
— Not Available
- 1. S-10 EL 4X2 REG. CAB (CS10603/E63/X81)
 - 2. S-10 4X2 REG. CAB (CS10603/E63/X96)
 - 3. S-10 4X2 REG. CAB (CS10803/E63)
 - 4. S-10 4X2 EXT. CAB (CS10653/E63)
 - 5. S-10 4X4 REG. CAB (CT10603/E63)
 - 6. S-10 4X4 REG. CAB (CT10803/E63)
 - 7. S-10 BAJA 4X4 REG. CAB (CT10603/E63/5Z7)
 - 8. S-10 4X4 EXT. CAB (CT10653/E63)
 - 9. S-10 BAJA EXT. CAB (CT10653/E63/5Z7)

NOTE: Refer to Dealer Order Guide for Updated Option Availability.

OPTION	CODE	DESCRIPTION	RESTRICTIONS	MODELS										
				2-WHEEL DRIVE				4-WHEEL DRIVE						
				1	2	3	4	5	6	7	8	9		
GLASS Heavily-Tinted — Sides and Rear	AJ1	Backlite and Rear Quarter; Ext. Cab Incls A20 Swing Out Windows	N/A A28 Window	—	O	O	O	O	O	O	O	O	O	O
HARNES, WIRING	U89	5-Lead w/H.D. Flasher	N/A Z82 Trailering	—	O	O	O	O	O	O	—	O	—	
LIGHTING, AUXILIARY	TR9	Regular Cab and Ext. Cab models also include Ashtray and Glove Box Lights and Headlamp Warning Buzzer. Models w/YC2 Tahoe Incl Eng Compartment Light and Interior Rearview Mirror w/Dual Reading Lamps only		—	O	O	O	O	O	O	O	O	O	
MIRRORS Exterior, Below-Eye-Line Type	D44	Black Incl w/YC2 Tahoe Mirror Head is 6.0" x 7.0"		—	O	O	O	O	O	O	S	O	S	
Lighted Visor, LH and RH	D74	Light Switch on Mirror		—	O	O	O	O	O	O	O	O	O	
MOLDINGS Wheel Opening (Black)	B74			—	O	O	O	O	O	O	S	O	S	
OPTION PACKAGE EL	X97	Incls Rear Step Bumper, 20-Gallon Fuel Tank and Full Size Spare Tire		O	—	—	—	—	—	—	—	—	—	
PAINT Solid	ZY1	(See Color and Trim)		S	S	S	S	S	S	S	S	S	S	
Special Two-Tone	ZY3	Incls D96 Striping and Chromed Bumpers	N/A YC2 Tahoe	—	O	O	O	O	O	—	O	—		
Deluxe Two-Tone	ZY4		Reqs YC2 Tahoe	—	O	O	O	O	O	—	O	—		
RADIO EQUIPMENT Electronically-Tuned AM Radio w/digital clock	UT5	14 Presets, Digital Display, Two 4" x 6" Front Speakers		O	S	S	S	S	S	S	S	S	S	
Electronically-Tuned AM/FM Stereo Radio w/Seek-Scan, Stereo Cassette Tape and Digital Clock	UM6	14 Presets, Digital Display, Two 4" x 6" Front Speakers, Two 4" x 10" ERS Rear Speakers, 28 Watts Total Power Output		—	O	O	O	O	O	O	O	O	O	
Electronically-Tuned AM AM/FM Stereo Radio w/Seek-Scan and Digital Clock	UM7	14 Presets, Digital Display, Two 4" x 6" Front Speakers, Two 4" x 10" ERS Rear Speakers, 28 Watts Power Output		—	O	O	O	O	O	O	O	O	O	
Electronically-Tuned AM Stereo/FM Stereo Radio w/Seek-Scan and Digital Cassette Tape w/Search-Repeat, Graphic Equalizer and Digital Clock	UX1	14 Presets, Digital Display Two 4" x 6" Front Speakers, Two 4" x 10" ERS Rear Speakers, 28 Watts Total Power Output		—	O	O	O	O	O	O	O	O	O	
Radio Delete	UL5			S	O	O	O	O	O	O	O	O	O	
SEATING	AJ2	Jump, Rear	Reqs Bucket Seats	—	—	—	O	—	—	—	O	O		
SHIELD PACKAGE	ZM5	Incls Transfer Case and Front Differential Skid Plates, Fuel Tank and Steering Linkage Shields	S-10 4-wheel drive only	—	—	—	—	O	O	S	O	S		
SHOCK ABSORBERS	F51	Front and Rear, Heavy-Duty; Incl w/F60 or ZQ8 Suspension w/o LB4 Eng	N/A ZM6 Suspension Equip Off-Road	—	O	O	O	O	O	—	O	—		
SPEED CONTROL, ELECTRONIC	KC4	Includes Resume Acceleration Feature		—	O	O	O	O	O	O	O	O		
SPRINGS, Front, Heavy-Duty	F60	Incl F51 Shock Absorbers;	N/A w/ZM6 Off-Road Suspension Package	—	—	—	—	O	O	—	O	—		
Rear, Heavy-Duty	G51		N/A w/QMW Tires	—	O	O	O	O	O	S	O	S		
STEERING Power Not Desired	N51	Manual Steering Gear	S-10 2-wheel drive only; N/A ZQ8 Susp or LB4 or LL2 Eng	S	S	S	—	—	—	—	—	—		
Power	N40	Std on S-10 4-wheel drive Incl w/ZQ8 Susp when L38 Eng is specified; Req w/LB4 or LL2 Eng		—	O	O	S	S	S	S	S	S		

- KEY S - Standard
O - Optional
— Not Available
- | | |
|---|---|
| 1. S-10 EL 4X2 REG. CAB (CS10603/E63/X81) | 6. S-10 4X4 REG. CAB (CT10803/E63) |
| 2. S-10 4X2 REG. CAB (CS10603/E63/X96) | 7. S-10 BAJA 4X4 REG. CAB (CT10603/E63/5Z7) |
| 3. S-10 4X2 REG. CAB (CS10803/E63) | 8. S-10 4X4 EXT. CAB (CT10653/E63) |
| 4. S-10 4X2 EXT. CAB (CS10653/E63) | 9. S-10 BAJA EXT. CAB (CT10653/E63/5Z7) |
| 5. S-10 4X4 REG. CAB (CT10603/E63) | |

NOTE: Refer to Dealer Order Guide for Updated Option Availability.

OPTION	CODE	DESCRIPTION	RESTRICTIONS	MODELS																
				2-WHEEL DRIVE				4-WHEEL DRIVE												
				1	2	3	4	5	6	7	8	9								
STRIPING		(See Color and Trim for Availability)																		
Body Striping	D96	Reqs ZY1 Paint; Incl w/ZY3 Paint		O	O	O	O	O	O	O	O	O	O	O	O	O	O	O	O	O
SUNROOF	AD3	Manual, Non-Removable; 5-Open Positions	Reqs A28 Sliding Rear Window w/YC2 on Reg Cab	—	O	O	O	O	O	O	O	O	O	O	O	O	O	O	O	O
SUSPENSION EQUIPMENT																				
Sport Chassis Package	ZQ8	Incls ZJ7 Rally Wheels and QPP Tires; w/L38 Incls F51 Shocks and N40 Steering w/Special Steering Ratio, W/LL2 Incls F51 Shocks	S-10 2-wheel drive Reg Cabs only	—	O	O	O	O	—	—	—	—	—	—	—	—	—	—	—	—
SUSPENSION PACKAGE, OFF-ROAD	ZM6	Incls Gas Shocks, Lgr Torsion Bars, Jounce Bumpers, H.D. Stabilizer Bar, Larger Body Mounts	Reqs G51 Springs and QEB Tires; N/A F51 Shocks or F60 Front Springs	—	—	—	—	—	O	O	S	O	S	O	S	O	S	O	S	
TAHOE	YC2	(See Trim Levels)		—	O	O	O	O	O	O	S	O	S	O	S	O	S	O	S	
TIRES (BW: Blackwall WW: Whitewall WL: White Lettered)		(See Wheels and Tires) Incls Front, Rear and Spare																		
P195/75R14 BW	QMW	All-Season Steel-Belted Radial	N/A G51 Rear Springs	S	S	S	S	—	—	—	—	—	—	—	—	—	—	—	—	—
P205/75R14 BW	QFT	All-Season Steel-Belted Radial		—	O	O	O	—	—	—	—	—	—	—	—	—	—	—	—	—
P205/75R14 WL	QSA	All-Season Steel-Belted Radial		—	O	O	O	—	—	—	—	—	—	—	—	—	—	—	—	—
P215/65R15 WL	QPP	Highway Steel-Belted Radial; Incls. 15" x 7" Rally Wheels		—	O	O	O	—	—	—	—	—	—	—	—	—	—	—	—	—
P205/75R15 BW	QCE	All-Season Steel-Belted Radial		—	—	—	—	S	S	—	—	—	—	—	—	—	—	—	—	—
P205/75R15 WL	QCF	All-Season Steel-Belted Radial		—	—	—	—	O	O	—	O	—	O	—	O	—	O	—	O	—
P205/75R15 BW	QJT	On-Off Road Steel-Belted Radial		—	—	—	—	O	O	—	O	—	O	—	O	—	O	—	O	—
P205/75R15 WL	QJL	On-Off Road Steel-Belted Radial		—	—	—	—	O	O	—	O	—	O	—	O	—	O	—	O	—
P235/75R15 WL	QEB	On-Off Road Steel-Belted Radial	Reqs 3.42 Rear Axle Ratio	—	—	—	—	O	O	—	O	—	O	—	O	—	O	—	O	—
LT235/75R15 WL	QBE	On-Off Road Steel-Belted Radial	Reqs 3.42 Rear Axle Ratio	—	—	—	—	—	—	S	—	S	—	S	—	S	—	S	—	S
TRAILERING SPECIAL EQUIPMENT (See Trailering Guide)	Z82	Heavy-Duty; Incls 7-lead Wiring Harness, HD Flasher, Weight Dist Platform Hitch	Reqs LB4 Eng, G51 Springs and KC4 Eng Oil Cooler. W/MX0 Trans reqs V02 Cooling. S-10 2-wheel drive reqs N40 Steering. 2-wheel Drive w/MM5 Trans reqs 3.08 or 3.42 Rear Axle	—	O	O	O	O	O	O	—	O	—	O	—	O	—	O	—	O
TRANSMISSIONS		(See Powertrains)																		
5-Speed Manual w/Overdrive	MM5			S	S	S	S	S	S	S	S	S	S	S	S	S	S	S	S	S
4-Speed Auto w/Overdrive	MX0		N/A LL2 Engine	—	O	O	O	O	O	O	O	O	O	O	O	O	O	O	O	O
WHEEL TRIM																				
Trim Rings	P06	Incl YC2 Tahoe		—	O	O	O	O	O	O	S	S	O	S	O	S	O	S	O	S
WHEELS																				
Aluminum, Cast	N90	15" x 7"	S-10 4-wheel drive only	—	—	—	—	O	O	—	O	—	O	—	O	—	O	—	O	—
Rally	ZJ7	14" x 6" w/Trim Rings	N/A YC2 Tahoe or QPP Tires	O	O	O	O	—	—	—	—	—	—	—	—	—	—	—	—	—
Baja, Aluminum Cast	5P2	15" x 7"	Incls Spare Aluminum Wheel w/5P3 Carrier only. Spare Wheel is Steel w/o 5P3	—	—	—	—	—	—	O	O	—	O	—	O	—	O	—	O	—
WINDOWS																				
Sliding Rear	A28		N/A AJ1 Glass	—	O	O	O	O	O	O	O	O	O	O	O	O	O	O	O	O

SOLID COLOR (ZY1)

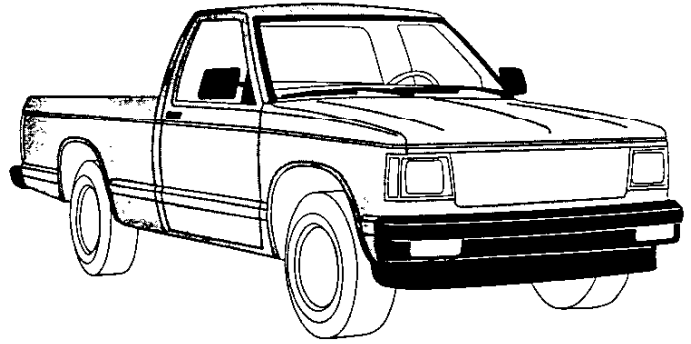

Solid Paint (ZY1) is standard on all models and requires the Standard S-10 or Tahoe YC2 trim level. The Tahoe trim level also includes bodyside moldings. All painted areas of the cab, front end sheet metal and box are the same color. The only available Color Code 1/Color Code 2 exterior paint combinations are those displayed in the chart below. Recommended interior trim colors are indicated by the symbol ●. However, any interior trim color that is not indicated as N/A may be ordered if desired by the customer. Also noted in the chart below are available D96 stripe colors. For more information, refer to Seats and Interior Trim pages as well as the Truck Order Guide.

KEY: ● — Recommended Blank — Available, But Not Recommended N/A — Not Available

EXTERIOR COLORS		STRIPE COLORS		INTERIOR COLORS		
COLOR CODE 1	COLOR CODE 2	D96 (Optional)	Blue	Charcoal	Garnet	Saddle
12 Frost White	12 Frost White	Blue	●	N/A	N/A	N/A
	12 Frost White	Silver	N/A	●	N/A	N/A
	12 Frost White	Vermillion	N/A	N/A	●	N/A
	12 Frost White	Brown	N/A	N/A	N/A	●
19 Midnight Black	19 Midnight Black	Brown	N/A	N/A	N/A	●
	19 Midnight Black	Silver	N/A	●	N/A	N/A
	19 Midnight Black	Vermillion	N/A	N/A	●	N/A
24 Aspen Blue Met.	24 Aspen Blue Met.	Silver	●	●		
26 Sky Blue	26 Sky Blue	Blue	●			
37 Wheat	37 Wheat	Brown				●
43 Mint Green	43 Mint Green	White		●		
47 Royal Blue Met.	47 Royal Blue Met.	Blue	●	N/A	N/A	N/A
	47 Royal Blue Met.	Silver	N/A	●	N/A	N/A
48 Garnet	48 Garnet	Silver	N/A	●	N/A	N/A
	48 Garnet	Brown	N/A	N/A	●	●
72 Apple Red	72 Apple Red	Silver	N/A	●	N/A	N/A
	72 Apple Red	Vermillion	N/A	N/A	●	N/A
90 Steel Gray Met.	90 Steel Gray Met.	Vermillion	N/A	N/A	●	N/A
	90 Steel Gray Met.	Silver	N/A	●	N/A	N/A

SPECIAL TWO-TONE (ZY3)

Special two-tone (ZY3) paint is available on all models with the Standard S-10 trim level only. Decal striping (D96) is also included. Color Code 1 is applied to the areas above the stripe, and Color Code 2 is applied to the areas below the stripe. The only available Color Code 1/Color Code 2 exterior paint combinations are those displayed in the chart below. Recommended interior trim colors are indicated by the symbol ●. However, any interior trim color that is not indicated as N/A may be ordered if desired by the customer. For more information, refer to Seats and Interior Trim pages as well as the Truck Order Guide.

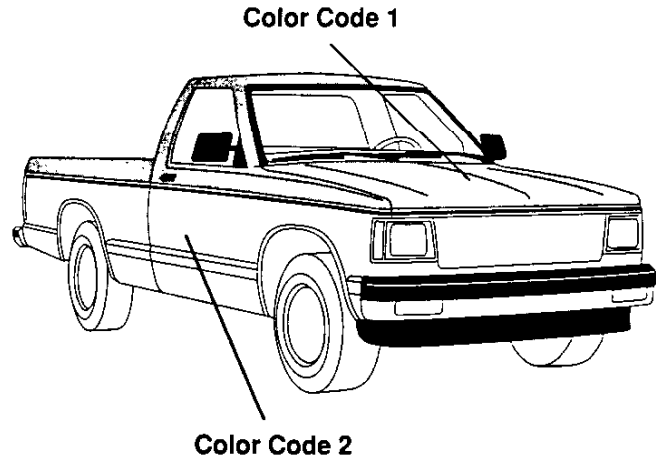

KEY: ● — Recommended Blank — Available, But Not Recommended N/A — Not Available

EXTERIOR COLORS			STRIPE COLORS		INTERIOR COLORS		
COLOR CODE 1	COLOR CODE 2	w/D96	Blue	Charcoal	Garnet	Saddle	
12 Frost White	26 Sky Blue	White	●	N/A	N/A	N/A	
	43 Mint Green	White	N/A	●	N/A	N/A	
	47 Royal Blue Met.	Blue	●				
	72 Apple Red	Silver		●	●		
	90 Steel Gray Met.	White or Blue		●	N/A		
	90 Steel Gray Met.	Vermillion	N/A	N/A	●	N/A	
19 Midnight Black	17 Silver Metallic	Vermillion	N/A	●	●	N/A	
	43 Mint Green	White		●			
	72 Apple Red	Vermillion	N/A	N/A	●	N/A	
	72 Apple Red	Silver	N/A	●	N/A	N/A	
	90 Steel Gray Met.	Silver		●	N/A		
	90 Steel Gray Met.	Vermillion	N/A	N/A	●	N/A	
24 Aspen Blue Met.	17 Silver Metallic	Blue	●	●			
	47 Royal Blue Met.	Blue	●				
26 Sky Blue	12 Frost White	Blue	●				
	47 Royal Blue Met.	Blue	●				
37 Wheat	12 Frost White	Brown				●	
43 Mint Green	12 Frost White	Green		●			
	19 Midnight Black	Green				●	
47 Royal Blue Met.	12 Frost White	Blue	●				
	17 Silver Metallic	Blue	●	●			
	24 Aspen Blue Met.	Blue	●				
	26 Sky Blue	Blue	●				
48 Garnet	12 Frost White	Silver	N/A	●	N/A	N/A	
	17 Silver Metallic	Vermillion		●	●		
	72 Apple Red	Silver		●	●		
	72 Apple Red	Vermillion	N/A	N/A	●	N/A	
	90 Steel Gray Met.	Silver	N/A	●	N/A	N/A	
	90 Steel Gray Met.	Vermillion	N/A	N/A	●	N/A	
72 Apple Red	12 Frost White	Vermillion		●	●		
	17 Silver Metallic	Vermillion		●	●		
	19 Midnight Black	Silver		●	N/A	N/A	
	19 Midnight Black	Vermillion	N/A	N/A	●		
	48 Garnet	Silver	N/A	●	N/A	N/A	
	48 Garnet	Vermillion	N/A	N/A	●	N/A	
	90 Steel Gray Met.	Silver		●	N/A	N/A	
	90 Steel Gray Met.	Vermillion	N/A	N/A	●		
90 Steel Gray Met.	17 Silver Metallic	Vermillion	N/A	●	●	N/A	
	19 Midnight Black	Silver	N/A	●	N/A	N/A	
	19 Midnight Black	Vermillion	N/A	N/A	●	N/A	

DELUXE TWO-TONE (ZY4)

Deluxe two-tone (ZY4) paint is available on all models with the optional Tahoe YC2 trim level only, which includes body side moldings and bright wheel opening moldings. The areas above the belt styling crease line and the moldings are painted Color Code 1. The areas between the line and the moldings are painted Color Code 2. The only available Color Code 1/Color Code 2 exterior paint combinations are those displayed in the chart below. Recommended interior trim colors are indicated by the symbol ●. However, any interior trim color that is not indicated as N/A may be ordered if desired by the customer. For more information, refer to Seats and Interior Trim pages as well as the Truck Order Guide.

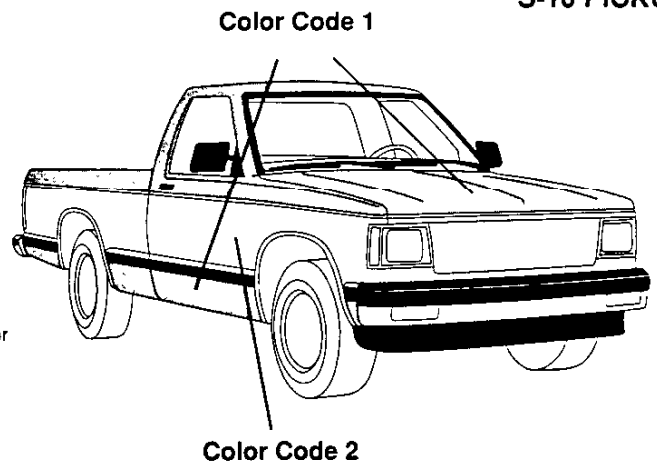

KEY: ● — Recommended Blank — Available, But Not Recommended

EXTERIOR COLORS		STRIPE COLORS	INTERIOR COLORS			
COLOR CODE 1	COLOR CODE 2		Blue	Charcoal	Garnet	Saddle
12 Frost White	26 Sky Blue	—	●			
	43 Mint Green	—		●		
	47 Royal Blue Met.	—	●			
	72 Apple Red	—		●	●	
	90 Steel Gray Met.	—		●	●	
19 Midnight Black	17 Silver Metallic	—		●	●	
	43 Mint Green	—		●		
	72 Apple Red	—		●	●	
	90 Steel Gray Met.	—		●	●	
24 Aspen Blue Met.	17 Silver Metallic	—	●	●		
	47 Royal Blue Met.	—	●			
26 Sky Blue	12 Frost White	—	●			
	47 Royal Blue Met.	—	●			
37 Wheat	12 Frost White	—				●
43 Mint Green	12 Frost White	—		●		
	19 Midnight Black	—				●
47 Royal Blue Met.	12 Frost White	—	●			
	17 Silver Metallic	—	●	●		
	24 Aspen Blue Met.	—	●			
	26 Sky Blue	—	●			
48 Garnet	12 Frost White	—		●	●	
	17 Silver Metallic	—		●	●	
	72 Apple Red	—		●	●	
	90 Steel Gray Met.	—		●	●	
72 Apple Red	12 Frost White	—		●	●	
	17 Silver Metallic	—		●	●	
	19 Midnight Black	—		●	●	
	48 Garnet	—		●	●	
	90 Steel Gray Met.	—		●	●	
90 Steel Gray Met.	17 Silver Metallic	—		●	●	
	19 Midnight Black	—		●	●	

3AJA SOLID COLOR (ZY1)

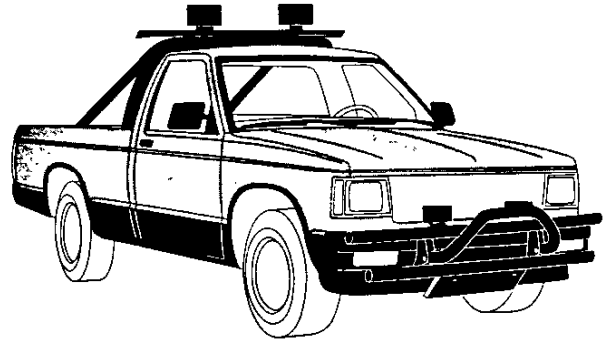

Solid Paint (ZY1) is standard on all Baja models. All painted areas of the cab, front end sheet metal and box are the same color. The only available Color Code 1/Color Code 2 exterior paint combinations are those displayed in the chart below. Recommended interior trim colors are indicated by the symbol ●. For more information, refer to Seats and Interior Trim pages as well as the Truck Order Guide.

KEY: ● — Recommended N/A — Not Available

EXTERIOR COLORS		STRIPE COLORS	INTERIOR COLORS			
COLOR CODE 1	COLOR CODE 2		Blue	Charcoal	Garnet	Saddle
12 Frost White	12 Frost White	N/A	N/A	●	N/A	N/A
19 Midnight Black	19 Midnight Black	N/A	N/A	●	N/A	N/A
72 Apple Red	72 Apple Red	N/A	N/A	●	N/A	N/A

Baja seats and door panels are charcoal and red in color. Please refer to Interior Trim and Seats for details.