

# MANUFACTURERS MOTOR VEHICLE SPECIFICATIONS

METRIC (U.S. Customary)

# 1993

B  
④

<b>Manufacturer</b> CHEVROLET MOTOR DIVISION GENERAL MOTORS CORPORATION	<b>Vehicle Line</b>  BERETTA	
<b>Mailing Address</b> CHEVROLET-PONTIAC-CANADA GROUP ENGINEERING CENTER GENERAL MOTORS CORPORATION 30003 VAN DYKE WARREN, MICHIGAN 48090-9060	<b>Issued</b> NOVEMBER, 1992	<b>Revised</b>

Direct questions concerning these specifications to the manufacturer listed above.

The information contained herein is prepared, distributed by, and is solely the responsibility of the vehicle manufacturing company to whose products it relates. This specification form was developed by the vehicle manufacturing companies under the auspices of the Motor Vehicle Manufacturers Association of the United States, Inc.

The General Specifications herein are those in effect at date of compilation and are subject to change without notice or incurring obligation by the manufacturer.



Motor Vehicle Manufacturers Association  
of the United States, Inc.

Blank Forms Provided by Technical Affairs Division

# MVMA Specifications

METRIC (U.S. Customary)

## Table of Contents

---

	1	Vehicle Models/Origin	<b>O</b>	<b>Indicates Format Change From Previous Year</b>
<b>O</b>	2	Power Teams		
	3	Engine		
	4	Lubrication System		
	4	Diesel Information		
<b>O</b>	5	Cooling System		
	6	Fuel System		
	7	Vehicle Emission Control		
	7	Exhaust System		
<b>O</b>	8-10	Transmission, Axles and Shafts		
	11	Suspension		
<b>O</b>	12-13	Brakes, Tires and Wheels		
	14	Steering		
	15-16	Electrical		
	17	Body — Miscellaneous Information		
	17	Frame		
	18	Restraint System		
<b>O</b>	18	Glass		
	18	Headlamps		
	19	Climate Control System		
<b>O</b>	20-21	Convenience Equipment		
	21	Trailer Towing		
	22-24	Vehicle Dimensions		
	25	Vehicle Fiducial Marks		
	26	Vehicle Mass (Weight)		
	27	Optional Equipment Differential Mass (Weight)		
	28-34	Vehicle Dimensions Definitions - Key Sheets		
	35	Index		

---

### NOTE:

1. This form uses both SI metric units and U.S. Customary units. The metric unit of measure is presented first, and the U.S. Customary unit follows in parentheses.
2. UNLESS OTHERWISE INDICATED:
  - a. Specifications apply to standard models without optional equipment. Significant deviations are noted.
  - b. Nominal design dimensions are used throughout these specifications.
  - c. All linear dimensions are in millimeters (inches), and all mass (weight) specifications are in kilograms (pounds).
3. The General Specifications herein are those in effect at date of compilation and are subject to change without notice or incurring obligation by the manufacturer.
4. Additional Vehicle Dimensions (based in part on SAE J1100 "Motor Vehicle Dimensions") may be available from the manufacturer.

# MVMA Specifications

Vehicle Line BERETTA  
 Model Year 1993 Issued 9-92 Revised(\*) \_\_\_\_\_

**METRIC (U.S. Customary)**

## Vehicle Origin

Design & development (company)	Chevrolet-Pontiac-GM of Canada
Where built (country)	U.S.A.
Authorized U.S. Sales marketing representative	Chevrolet Motor Division

## Vehicle Models

Model Description & Drive (FWD/RWD/AWD/4WD)*	Make, Vehicle Models, Series, Body Type (Mfr's Model Code)	No. of Designated Seating Positions (Front/Rear)	Max. Trunk/Cargo Load-Kilograms (Pounds)	EPA Fuel Economy (City/Hwy)
BERETTA 2-Door Notchback Coupe (FWD)	1LV37	5 (2/3)	64 (141)	25/34
BERETTA 'GT' 2-Door Notchback Coupe (FWD)	1LW37	5 (2/3)	64 (141)	25/34
BERETTA 'GTZ' 2-Door Notchback Coupe (FWD)	1LZ37	5 (2/3)	64 (141)	21/30

\* FWD - Front Wheel Drive RWD - Rear Wheel Drive AWD - All Wheel Drive 4WD - Four Wheel Drive





# MVMA Specifications

Vehicle Line BERETTA  
 Model Year 1993 Issued 9-92 Revised(\*) \_\_\_\_\_

## METRIC (U.S. Customary)

Engine Description 2.2 LITER L4 (133 CID)  
 Engine Code MULTI-PORT FUEL INJECTION RPO LN2

### ENGINE - GENERAL

Type & description (inline, V, angle, flat, location, front, mid, rear, transverse, longitudinal, sohc, dohc, ohv, hemi, wedge, pre-chamber, etc.)		Inline, Front, Transverse - OHV
Manufacturer		General Motors Powertrain Division
No. of cylinders		4
Bore		89.0 mm (3.50 in.)
Stroke		88.0 mm (3.46 in.)
Bore spacing (C/L to C/L)		99.0 mm (3.90 in.)
Cyl block matl & mass kg(lbs.)(machined)		Cast Iron, 40 (88)
Cylinder block deck height		216.65 mm (8.53 in.)
Cylinder block length		443 mm (17.44 in.)
Deck clearance (minimum) (above or below block)		.6 mm (.024 in.) Below
Cyl. head material & mass kg (lbs.)		Aluminum, 9.7 (21.3)
Cylinder head volume cu. cm. (cu. in.)		32.8 (2.00)
Cylinder liner material		No Liner
Head gasket thickness (compressed)		1.50 (.059)
Minimum combustion chamber total volume cu. cm. (cu. in.)		67.34 (4.11)
Cyl. no. system (front to rear)*	L. Bank	1-2-3-4
	R. Bank	-
Firing order		1-3-4-2
Intake manifold matl & mass kg (lbs.)**		Aluminum, 3.9 (8.6)
Exh. manifold matl & mass kg (lbs.)**		Nodular Cast Iron, 4.5 (10)
Knock sensor (number & location)		None
Fuel required unleaded, diesel, etc.		Unleaded
Fuel antiknock index (R + M) / 2		87
Engine mounts	Quantity	3 Manual <span style="float: right;">2 Auto</span>
	Matl and type (elastomeric, hydroelastic, hydraulic damper, etc.)	Hydroelastic <span style="float: right;">Elastomeric</span>
	Added isolation (sub-frame, crossmember, etc.)	No
Total dressed engine mass (wt) dry***		163.3 kg. (359 lbs.), Manual <span style="float: right;">147.7 kg. (325 lbs.), Automatic</span>

### Engine - Pistons

Material & mass, g (weight, oz.) - piston only	Aluminum, 328 (11.57)
--	-----------------------

### Engine Camshaft

Location		In Block, Right Side
Material & mass kg (weight, lbs.)		Cast Iron, 3.1 (6.8)
Drive type	Chain/belt	Chain
	Width/pitch	19.3 / 9.5 mm (.76 / .37 in.)

\*Rear of engine - drive takeoff. View from drive takeoff end to determine left & right side of engine.

\*\*Finished state.

\*\*\*Dressed engine mass (weight) includes the following:

All those items necessary to make the engine a complete ready-to-run unit.

# MVMA Specifications

Vehicle Line BERETTA  
 Model Year 1993 Issued 9-92 Revised(\*)

## METRIC (U.S. Customary)

Engine Description  
 Engine Code

3.1 LITER V6 (191 CID)  
 MULTI-PORT FUEL INJECTION RPO LHO

### ENGINE - GENERAL

Type & description (inline, V, angle, flat, location, front, mid, rear, transverse, longitudinal, sohc, dohc, ohv, hemi, wedge, pre-chamber, etc.)		60 deg. V, Front, Transverse, OHV	
Manufacturer		General Motors Powertrain Division	
No. of cylinders		6	
Bore		89 (3.5)	
Stroke		84 (3.3)	
Bore spacing (C/L to C/L)		111.76 (4.4)	
Cyl block matl & mass kg(lbs.)(machined)		Cast Iron, 53.12 (117.0)	
Cylinder block deck height		224.0mm (9.0 in.)	
Cylinder block length		435.5mm (17.4 in.)	
Deck clearance (minimum) (above or below block)		0.12 mm (.005 in.) Below Block, Nominal (+/- 0.24 mm)	
Cyl. head material & mass kg (lbs.)		Aluminum, 5.30 (11.7)	
Cylinder head volume cu. cm. (cu. in.)		28.0 (1.71)	
Cylinder liner material		Not Applicable	
Head gasket thickness (compressed)		1.62mm (.062 in.)	
Minimum combustion chamber total volume cu. cm. (cu. in.)		27.9 (1.70)	
Cyl. no. system (front to rear)**	L. Bank	2-4-6	
	R. Bank	1-3-5	
Firing order		1-2-3-4-5-6	
Intake manifold matl & mass kg (lbs.)**		Upper Manifold - Aluminum Alloy, 3.5 (7.9) Lower Manifold - Aluminum Alloy, 6.3 (13.8)	
Exh. manifold matl & mass kg (lbs.)**		Nodular Cast Iron, Wt. Of Manifold, Fire Wall Side 3.76 (8.283); Wt. Of Other Manifold, 2.63 (5.786)	
Knock sensor (number & location)		1 - Right Side Of Block	
Fuel required unleaded, diesel, etc.		Unleaded	
Fuel antiknock index (R + M) / 2		87	
Engine mounts	Quantity	3 Manual	2 Auto
	Matl and type (elastomeric, hydroelastic, hydraulic damper, etc.)	Elastomeric	Hydroelastic
	Added isolation (sub-frame, crossmember, etc.)	Not Applicable	
Total dressed engine mass (wt) dry***		153.32 kg. (338.0 lbs.), Auto.; 157.60 kg. (347.4 lbs.), Manual	

### Engine - Pistons

Material & mass, g (weight, oz.) - piston only	Aluminum Alloy, 365 (12.8)
--	----------------------------

### Engine Camshaft

Location	Cylinder Block	
Material & mass kg (weight, lbs.)	Cast Iron, 3.098 (6.83)	
Drive type	Chain/belt	Chain
	Width/pitch	15.875 x 9.525mm (0.625 x 0.375 in.)

\*Rear of engine - drive takeoff. View from drive takeoff end to determine left & right side of engine.

\*\*Finished state.

\*\*\*Dressed engine mass (weight) includes the following:

All those items necessary to make the engine a complete ready-to-run unit.

# MVMA Specifications

Vehicle Line BERETTA  
 Model Year 1993 Issued 9-92 Revised \_\_\_\_\_

## METRIC (U.S. Customary)

Engine Description  
 Engine Code

2.3 LITER L4 (138 CID)  
 MULTI-PORT FUEL INJECTION RPO LGO

### ENGINE - GENERAL

Type & description (inline, V, angle, flat, location, front, mid, rear, transverse, longitudinal, sohc, dohc, ohv, hemi, wedge, pre-chamber, etc.)	Inline, Front, Transverse, Pent Roof	
Manufacturer	General Motors Powertrain Division	
No. of cylinders	4	
Bore	92 mm (3.63 in.)	
Stroke	85 mm (3.35 in.)	
Bore spacing (C/L to C/L)	100 mm (3.94 in.)	
Cyl blk matl & mass kg(lbs.)(machined)	Cast Iron, 48.05 (105.93)	
Cylinder block deck height	222 mm (8.74 in.)	
Cylinder block length	499.5 (19.66)	
Deck clearance (minimum) (above or below block)	0	
Cyl. head material & mass kg (lbs.)	Aluminum Alloy, 8.60 (18.96)	
Cylinder head volume cu. cm. (cu. in.)	47.0 +/- 1.5 cc	
Cylinder liner material	None	
Head gasket thickness (compressed)	1.10 (.043)	
Minimum combustion chamber total volume cu. cm. (cu. in.)	62.8	
Cyl. no. system (front to rear)*	L. Bank	1-2-3-4
	R. Bank	None
Firing order	1-3-4-2	
Intake manifold matl & mass kg (lbs.)**	Aluminum, 5.3 (11.72)	
Exh. manifold matl & mass kg (lbs.)**	Cast Iron, 6.74 (14.86)	
Knock sensor (number & location)	0	
Fuel required unleaded, diesel, etc.	Unleaded	
Fuel antiknock index (R + M) / 2	87	
Engine mounts	Quantity	2
	Matl and type (elastomeric, hydroelastic, hydraulic damper, etc.)	Elastomeric      Hydroelastic
	Added isolation (sub-frame, crossmember, etc.)	No
Total dressed engine mass (wt) dry***	158.30 (348.99)	

### Engine - Pistons

Material & mass, g (weight, oz.) - piston only	Aluminum 419 (14.78)
--	----------------------

### Engine Camshaft

Location	Overhead	
Material & mass kg (weight, lbs.)	Intake	3.045 (6.713)
	Exhaust	2.948 (6.499)
Drive type	Chain/belt	Chain
	Width/pitch	22.86 mm      9.525mm (.375 in.) Duplex ~ 130 pitches

\*Rear of engine - drive takeoff. View from drive takeoff end to determine left & right side of engine.  
 \*\*Finished state.  
 \*\*\*Dressed engine mass (weight) includes the following:



# MVMA Specifications

Vehicle Line BERETTA  
 Model Year 1993 Issued 9-92 Revised(\*)           

## METRIC (U.S. Customary)

Engine Description  
 Engine Code

2.2 LITER L4 (133 CID)  
 MULTI-PORT FUEL INJECTION RPO LN2

### Engine - Valve System

Hydraulic lifters (std., opt., n.a.)		Standard
Valves	Number intake/exhaust	4/4
	Head O.D. intake/exhaust	44.0 mm (1.73 in.) / 37.0 mm (1.46 in.)

### Engine - Connecting Rods

Material & mass kg., (weight, lbs.)*	Forged Steel, .540 (1.19)
Length (axes centerline to centerline)	141.95 (5.59)

### Engine - Crankshaft

Material & mass kg., (weight, lbs.)*	Nodular Cast Iron, 14.4 (31.7)	
End thrust taken by bearing (no.)	4	
Length & number of main bearings	5, 20.72 mm (.82 in.)	
Seal (material, one, two piece design, etc.)	Front	One Piece Fluoroelastomer
	Rear	One Piece Fluoroelastomer

### Engine - Lubrication System

Normal oil pressure kPa (psi) @ eng rpm	435-530 (63-77) @ 1200
Type oil intake (floating, stationary)	Stationary
Oil filter sys. (full flow, part, other)	Full Flow
Capacity of c/case, less filter-refill-L (qt.)	3.8 (4.0)

### Engine - Diesel Information

(NOT APPLICABLE)

Diesel engine manufacturer		
Glow plug, current drain at 0 deg. F		
Injector Nozzle	Type	
	Opening pressure kPa (psi)	
Pre-chamber design		
Fuel injection pump	Manufacturer	
	Type	
Fuel inj. pump drive (belt, chain, gear)		
Supplementary vacuum source (type)		
Fuel heater (yes/no)		
Water separator, description (std., opt.)		
Turbo manufacturer		
Oil cooler-type (oil to engine coolant; oil to ambient air)		
Oil filter		

### Engine - Intake System

(NOT APPLICABLE)

Turbo charger - manufacturer		
Super charger - manufacturer		
Intercooler		

\* Finished State

# MVMA Specifications

Vehicle Line BERETTA  
 Model Year 1993 Issued 9-82 Revised(\*) \_\_\_\_\_

## METRIC (U.S. Customary)

Engine Description	3.1 LITER V6 (191 CID)
Engine Code	MULTI-PORT FUEL INJECTION RPO LHO

### Engine - Valve System

Hydraulic lifters (std., opt., n.a.)	Standard	
Valves	Number intake/exhaust	8/6
	Head O.D. intake/exhaust	43.64mm (1.72 in.) / 36.20mm (1.43 in.)

### Engine - Connecting Rods

Material & mass kg., (weight, lbs.)*	Forged Steel, .592 (1.31) Full Assembly
Length (axes centerline to centerline)	144.78 (5.79)

### Engine - Crankshaft

Material & mass kg., (weight, lbs.)*	Nodular Cast Iron, 17.2 (37.9)	
End thrust taken by bearing (no.)	3	
Length & number of main bearings	** 4 Bearings	
Seal (material, one, two piece design, etc.)	Front	Viton/Steel, One Piece
	Rear	Viton/Steel, One Piece

### Engine - Lubrication System

Normal oil pressure kPa (psi) @ eng rpm	345-450 (50-65) @ 2400
Type oil intake (floating, stationary)	Stationary
Oil filter sys. (full flow, part, other)	Full Flow
Capacity of c/case, less filter-refill-L (qt)	3.8 (4.0)

### Engine - Diesel Information

(NOT APPLICABLE)

Diesel engine manufacturer		
Glow plug, current drain at 0 deg. F		
Injector Nozzle	Type	
	Opening pressure kPa (psi)	
Pre-chamber design		
Fuel injection pump	Manufacturer	
	Type	
Fuel inj. pump drive (belt, chain, gear)		
Supplementary vacuum source (type)		
Fuel heater (yes/no)		
Water separator, description (std., opt.)		
Turbo manufacturer		
Oil cooler-type (oil to engine coolant; oil to ambient air)		
Oil filter		

### Engine - Intake System

(NOT APPLICABLE)

Turbo charger - manufacturer	
Super charger - manufacturer	
Intercooler	

\* Finished State

\*\* Bearing Overall Length:

For 3.1L V6: #1, 4 = 29.5 mm (1.16 in.); #2, 3 = 24.0 mm (0.96 in.)

# MVMA Specifications

Vehicle Line BERETTA  
 Model Year 1993 Issued 9-92 Revised(\*)           

## METRIC (U.S. Customary)

Engine Description  
 Engine Code

2.3 LITER L4 (138 CID)  
 MULTI-PORT FUEL INJECTION RPO LGO

### Engine - Valve System

Hydraulic lifters (std., opt., n.a.)		Standard
Valves	Number intake/exhaust	8/8
	Head O.D. intake/exhaust	36.50 mm (1.44 in.) / 31.50 mm (1.24 in.)

### Engine - Connecting Rods

Material & mass kg., (weight, lbs.) *	Steel, .689 (1.5) Each
Length(axes centerline to centerline)	147.5 (5.81)

### Engine - Crankshaft

Material & mass kg., (weight, lbs.) *	Nodular Iron, 19.0 (41.9)	
End thrust taken by bearing (no.)	#3	
Length & number of main bearings	#1, 2, 4, & 5 21.25 mm (.84 in.) #3 27.25 mm (1.09 in.)/5	
Seal (material, one, two piece design, etc.)	Front	One Piece, Viton
	Rear	One Piece, Viton

### Engine - Lubrication System

Normal oil pressure kPa(psi) @ eng rpm	207 (30) @ 2000
Type oil intake (floating, stationary)	Stationary Pick-Up
Oil filter sys. (full flow, part, other)	Full Flow
Capacity of c/case, less filter-refill-L (qt.)	3.79 (4)

### Engine - Diesel Information

(NOT APPLICABLE)

Diesel engine manufacturer		
Glow plug, current drain at 0 deg. F		
Injector Nozzle	Type	
	Opening pressure kPa(psi)	
Pre-chamber design		
Fuel injection pump	Manufacturer	
	Type	
Fuel inj. pump drive (belt, chain, gear)		
Supplementary vacuum source (type)		
Fuel heater (yes/no)		
Water separator, description (std., opt.)		
Turbo manufacturer		
Oil cooler-type (oil to engine coolant; oil to ambient air)		
Oil filter		

### Engine - Intake System

(NOT APPLICABLE)

Turbo charger - manufacturer		
Super charger - manufacturer		
Intercooler		

\* Finished State

# MVMA Specifications

Vehicle Line BERETTA  
 Model Year 1993 Issued 9-92 Revised \_\_\_\_\_

## METRIC (U.S. Customary)

Engine Description  
 Engine Code

2.2 LITER L4 (133 CID)  
 MULTI-PORT FUEL INJECTION RPO LN2

### Engine - Cooling System

Coolant recovery system (std., opt., n.a.)		Standard
Coolant fill location (rad., bottle)		Surge Tank
Radiator cap relief valve pressure kPa (psi)		124 (18)
Circulation thermostat	Type (choke, bypass)	Choke
	Starts to open @ deg's C(F)	89 (192)
Water Pump	Type (centrifugal, other)	Centrifugal
	GPM 1000 pump rpm	7.3
	Number of pumps	1
	Drive (V-belt, other)	V-Belt
	Bearing type	Sealed, Ball Roller
	Impeller material	Stamped Steel
	Housing material	Aluminum
By-pass recirculation type (inter., ext.)		External - Thru Intake Manifold Internal
Cooling system capacity	With heater - L (qt.)	8.7 (9.2)
	With air conditioner-L(qt.)	8.7 (9.2)
	Opt. equip. specify-L(qt.)	
Water jackets full length of cy(yes,no)		Yes
Water all around cylinder (yes, no)		Yes
Water jackets open at head face (yes,no)		Yes
Radiator core	Std., A/C, HD	Standard <span style="float: right;">A/C</span>
	Type (cross-flow, etc.)	Cross-Flow
	Construction (fin & tube mechanical, braze, etc.)	Tube & Center / Brazed
	Matl., mass kg (wgt., lbs.)	Aluminum 3.08 (6.78), Standard; 3.95 (8.69), Auto.
	Width	660 (26)
	Height	383 (15)
	Thickness	24 (.9)
Fins per inch		13, Standard <span style="float: right;">17, Auto.</span>
Radiator end tank material		Plastic
O  Fan	Std., elec., opt.	Electric, Standard <span style="float: right;">Air Conditioned</span>
	Number of blades & type (flex, solid, material)	5 Plastic <span style="float: right;">7 Plastic</span>
	Number & location (front, rear of radiator)	
	Diameter & projected width	290 (11.4) <span style="float: right;">373 (14.7)</span>
	Ratio(fan to crnkshft.rev.)	Not Applicable
	Fan cutout type	ECM Controlled
	Drive type (direct, remote)	Direct - Electric Motor
	RPM at idle (elec.)	1800
	Motor rating(wattage/elec.)	100
	Motor switch (type & location/elec.)	ECM
Switch point (temp./ pressure/elec.)		On At 108; Off at 101 <span style="float: right;">On At 106; Off At 99</span>
Fan shroud (material)		None <span style="float: right;">Plastic</span>

# MVMA Specifications

Vehicle Line BERETTA  
 Model Year 1993 Issued 9-92 Revised \_\_\_\_\_

## METRIC (U.S. Customary)

Engine Description  
 Engine Code

3.1 LITER V6 (191 CID)  
 MULTI-PORT FUEL INJECTION RPO LH0

### Engine - Cooling System

Coolant recovery system (std, opt, n.a.)		Standard
Coolant fill location (rad., bottle)		Surge Tank
Radiator cap relief valve pressure kPa (psi)		124 (18), Surge Tank Cap
Circulation thermostat	Type (choke, bypass)	Bypass
	Starts to open @ deg's C(F)	90 (195)
Water Pump	Type (centrifugal, other)	Centrifugal
	GPM 1000 pump rpm	12
	Number of pumps	1
	Drive (V-belt, other)	Serpentine
	Bearing type	Ball-Roller
	Impeller material	Cast Iron
	Housing material	Aluminum
By-pass recirculation type (inter., ext.)		External, Bypass
Cooling system capacity	With heater - L (qt.)	12.33 (13.1)
	With air conditioner-L(qt.)	12.47 (13.2)
	Opt. equip. specify-L(qt.)	None
Water jackets full length of cyl(yes,no)		Yes, Outer Wall; No, Inner Wall
Water all around cylinder (yes, no)		Yes
Water jackets open at head face (yes,no)		Yes
Radiator core	Std., A/C, HD	All
	Type (cross-flow, etc.)	Cross Flow
	Construction (fin & tube mechanical, braze, etc.)	Tube & Fine/Brazed
	Matl. mass kg (wt.,lbs.)	Aluminum 4.20 (9.24), Standard; 4.88 (10.74), Auto.
	Width	660 (26)
	Height	383 (15.1)
	Thickness	24 (0.9), Standard 34 (1.3)
Fins per inch		17
Radiator end tank material		Plastic
Fan	Std., elec., opt.	Electric - Standard Air Conditioned
	Number of blades & type (flex, solid, material)	5 Plastic 6 Plastic
	Number & location (front, rear of radiator)	
	Diameter & projected width	290 (11.4) 373 (14.7)
	Ratio(fan to crnkshft.rev.)	Not Applicable
	Fan cutout type	ECM Controlled
	Drive type (direct, remote)	Electric
	RPM at idle (elec.)	1800
	Motor rating(wattage/elec.)	100 150
	Motor switch (type & location/elec.)	ECM
Switch point (temp.,/ pressure/elec.)	On At 190, Off At 100 PSI A/C Pressure On At 106, Off At 100 Deg. C	
Fan shroud (material)		None Plastic

# MVMA Specifications

Vehicle Line BERETTA  
 Model Year 1993 Issued 9-92 Revised \_\_\_\_\_

## METRIC (U.S. Customary)

Engine Description	2.3 LITER L4 (138 CID)
Engine Code	MULTI-PORT FUEL INJECTION RPO LG0

### Engine - Cooling System

Coolant recovery system (std, opt, n.a.)		Standard
Coolant fill location (rad., bottle)		Surge Tank
Radiator cap relief valve pressure kPa (psi)		124 (18), Surge Tank Cap
Circulation thermostat	Type (choke, bypass)	Bypass
	Starts to open @ deg's C(F)	89 (192)
Water Pump	Type (centrifugal, other)	Centrifugal
	GPM 1000 pump rpm	6.5
	Number of pumps	1
	Drive (V-belt, other)	Chain
	Bearing type	2 Row Ball
	Impeller material	Sheet Metal
	Housing material	Die Cast Aluminum
By-pass recirculation type (inter., ext.)		External - Heater Water Flow & Throttle Body Water Flow
Cooling system capacity	With heater - L (qt.)	9.8 (10.4)
	With air conditioner-L(qt.)	9.8 (10.4)
	Opt. equip. specify-L(qt.)	None
Water jackets full length of cy(yes,no)		Yes
Water all around cylinder (yes, no)		Partial
Water jackets open at head face (yes,no)		Partial
Radiator core	Std., A/C, HD	Standard & A/C
	Type (cross-flow, etc.)	Cross-Flow
	Construction (fin & tube mechanical, braze, etc.)	Tube & Center / Brazed
	Matl. mass kg (wgt., lbs.)	Aluminum 3.08 (6.78)
	Width	660 (26)
	Height	383 (15.1)
	Thickness	24 (0.9)
Radiator end tank material		Plastic
Fan	Std., elec., opt.	Electric
	Number of blades & type (flex, solid, material)	6 - Nylon 6/6 Mineral Filled
	Number & location (front, rear of radiator)	
	Diameter & projected width	381 (15.0)
	Ratio(fan to crnkshft.rev.)	Not Applicable
	Fan cutout type	Engine Control Module (ECM)
	Drive type (direct, remote)	Electric - Direct
	RPM at idle (elec.)	1800
	Motor rating(wattage/elec.)	150
	Motor switch (type & location/elec.)	ECM
Switch point (temp.,/ pressure/elec.)	One At 106 deg. (223) Coolant Temperature Or 190 PSI A/C Head Pressure	
Fan shroud (material)		None

# MVMA Specifications

Vehicle Line BERETTA  
 Model Year 1993 Issued 9-92 Revised(\*) \_\_\_\_\_

## METRIC (U.S. Customary)

Engine Description  
 Engine Code

2.2 LITER L4 (133 CID)  
 MULTI-PORT FUEL INJECTION RPO LN2

### Engine - Fuel System (See supplemental page for details of Fuel Inj, Supercharger, Turbocharger, etc. if used)

Induction type: carburetor, fuel injection system, etc.		Fuel Injection
Manufacturer		AC/Rochester Products
Carburetor no. of barrels		None
Idle A/F mix.		Preset - No Adjustment Provided
Fuel Injection	Point of inj. (no.)	Entering Cylinder Head (Four)
	Constant, pulse, flow	Pulse
	Control (elec., mech.)	Electronic
	Sys. press. kPa (psi)	294 - 306 (43 - 44)
Idle spd.-rpm (spec. neutral or drive and propane if used)	Manual	900 In Neutral
	Automatic	700 In Drive.
Intake manifold heat control (exhaust or water thermostatic or fixed)		None
Air cleaner type		Single Snorkel
Fuel filter (type/location)		Replaceable Paper Element Located Near Fuel Tank
Fuel pump	Type (elec. or mech.)	Electrical
	Location (eng., tank)	Fuel tank
	Press. range kPa (psi)	Pressure Depends On Flow Rate And System Voltage
	Flow rate at regulated pressure (L (gal)/hr @ kPa (psii))	62.4 @ 350 (16.51 @ 50.8) Figures For Wide Open Throttle

### Fuel Tank

Capacity refill L (gallons)		59.0 (15.6)
Location (describe)		Under Rear Seat (Forward Of Rear Axle)
Attachment		Two Longitudinal Steel Straps
Material & Mass kg (weight lbs.)		High Density Polyethylene 8.92 (20.46) W/Sender
Filler pipe	Location & material	Right Rear Quarter - Steel
	Connection to tank	Fuel Filler And Vent Hose With Clamps
Fuel line (material)		Steel/Nylon With Quick Connect Fittings
Fuel hose (material)		Filler Hose - Rubber
Return line (material)		Steel/Nylon With Quick Connect Fittings
Vapor line (material)		Steel/Rubber
Extended range tank	Opt., n.a.	Not Applicable
	Capacity L (gallons)	"
	Location & material	"
	Attachment	"
Auxiliary tank	Opt., n.a.	"
	Capacity L (gallons)	"
	Location & material	"
	Attachment	"
	Sictr switch or valve	"
	Separate fill	"

# MVMA Specifications

Vehicle Line BERETTA  
 Model Year 1993 Issued 9-92 Revised(\*) \_\_\_\_\_

## METRIC (U.S. Customary)

Engine Description  
 Engine Code

3.1 LITER V6 (191 CID)  
 MULTI-PORT FUEL INJECTION RPO LHO

### Engine - Fuel System (See supplemental page for details of Fuel Inj, Supercharger, Turbocharger, etc. if used)

Induction type: carburetor, fuel injection system, etc.		Fuel Injection
Manufacturer		AC/Rochester Products
Carburetor no. of barrels		None
Idle A/F mix.		Preset-No Adjustment Provided
Fuel Injection	Point of inj. (no.)	Fuel Injectors At Inlet Ports
	Constant, pulse, flow	Pulse
	Control (elec., mech.)	Electronic
	Sys. press. kPa (psi)	300 (43.5), Regulated To Manifold Pressure
Idle spd.-rpm (spec. neutral or drive and propane if used)	Manual	Not Applicable
	Automatic	600 In Drive
Intake manifold heat control (exhaust or water thermostatic or fixed)		Throttle Body Water Heat - No Induction Air Heat
Air cleaner type		Single Snorkel, Replaceable Paper Element
Fuel filter (type/location)		Replaceable Enclosed Paper Element Located Near Fuel Tank.
Fuel pump	Type (elec. or mech.)	Electrical
	Location (eng., tank)	Fuel Tank
	Press. range kPa (psi)	Normal Operating Range 250 To 300 kPa (36 to 44 psi)
	Flow rate at regulated pressure (L (gal)/hr @ kPa (psi))	62.4 @ 350 (Pump Rating) (16.51 @ 50.8)

### Fuel Tank

Capacity refill L (gallons)		59.0 (15.6)
Location (describe)		Under Rear Seat (Forward Of Rear Axle)
Attachment		Two Longitudinal Steel Straps
Material & Mass kg (weight lbs.)		High density Polyethylene 8.92 (20.46) W/Sender
Filler pipe	Location & material	Right Rear Quarter - Steel
	Connection to tank	Fuel Filler And Vent Hose With Clamps
Fuel line (material)		Steel/Nylon With Quick Connect Fittings
Fuel hose (material)		Filler Hose - Rubber
Return line (material)		Steel/Nylon With Quick Connect Fittings
Vapor line (material)		Steel/Rubber
Extended range tank	Opt., n.a.	Not Applicable
	Capacity L (gallons)	"
	Location & material	"
	Attachment	"
Auxiliary tank	Opt., n.a.	"
	Capacity L (gallons)	"
	Location & material	"
	Attachment	"
	Sicr switch or valve	"
Separate fill		"



# MVMA Specifications

Vehicle Line BERETTA  
 Model Year 1993 Issued 9-92 Revised(\*) \_\_\_\_\_

## METRIC (U.S. Customary)

Engine Description	2.3 LITER L4 (138 CID)
Engine Code	MULTI-PORT FUEL INJECTION RPO LGO

### Engine - Fuel System (See supplemental page for details of Fuel Inj, Supercharger, Turbocharger, etc. if used)

Induction type: carburetor, fuel injection system, etc.		Port Fuel Injection
Manufacturer		AC/Rochester Products
Carburetor no. of barrels		None
Idle A/F mix.		ECM Controlled
Fuel injection	Point of inj. (no.)	4 Injectors At Ports In Cylinder Head
	Constant, pulse, flow	Pulse
	Control (elec., mech.)	Electronic
	Sys. press. kPa (psi)	300 (43)
Idle spd.-rpm (Spec. neutral or drive and propane if used)	Manual	
	Automatic	
Intake manifold heat control (exhaust or water thermostatic or fixed)		None
Air cleaner type		Single Snorkel, Remote Mounted, Replaceable Paper Element
Fuel filter (type/location)		Replaceable Enclosed Paper Element Located Near Fuel Tank
Fuel pump	Type (elec. or mech.)	Electrical
	Location (eng., tank)	Fuel Tank
	Press. range kPa (psi)	Pressure Depends On Flow Rate And System Voltage
	Flow rate at regulated pressure (L (gal)/hr @ kPa (psi))	62.4 @ 350 (Figures For Wide Open Throttle) (16.51 @ 50.8)

### Fuel Tank

Capacity refill L (gallons)		59.0 (15.6)
Location (describe)		Under Rear Seat (Forward Of Rear Axle)
Attachment		Two Longitudinal steel Straps
Material & Mass kg (weight lbs.)		High Density Polyethylene 8.92 (20.46) W/Sender
Filler pipe	Location & material	Right rear Quarter - Steel
	Connection to tank	Fuel Filler And Vent Hose With Clamps
Fuel line (material)		Steel/Nylon With Quick Connect Fittings
Fuel hose (material)		Filler Hose - rubber
Return line (material)		Steel/Nylon With Quick Connect Fittings
Vapor line (material)		Steel/Rubber
Extended range tank	Opt., n.a.	Not Applicable
	Capacity L (gallons)	"
	Location & material	"
	Attachment	"
Auxiliary tank	Opt., n.a.	"
	Capacity L (gallons)	"
	Location & material	"
	Attachment	"
	Sictr switch or valve	"
Separate fill		"

# MVMA Specifications

Vehicle Line BERETTA  
 Model Year 1993 Issued 9-92 Revised(\*)

## METRIC (U.S. Customary)

Engine Description **2.2 LITER L4 (133 CID)**  
 Engine Code **MULTI-PORT FUEL INJECTION RPO LN2**

## Vehicle Emission Control

Exhaust Emission Control	Type (air injection, engine modifications, other)		CCC Control
	Air injection	Pump or pulse	Not
		Driven by	Applicable
		Air distribution (head, manifold, etc.)	
		Point of entry	
	Exhaust Gas Recirculation	Type (controlled flow, open orifice, other)	Negative Back Pressure EGR Valve With Integral Transducer And Single Shaft Cross Hole
		Exhaust source	#4 Cylinder At Cylinder Head
		Point of exh.inj. (spacer, carb. manifold, other)	Inlet Manifold
	Catalytic Converter	Type	3-Way Monolith
		Number of	1
Location(s)		Mounted To Center Underbody	
Volume L (cu.in)		1.8 (110)	
Substrate type		Monolith	
Noble metal type		Palladium (Pd), Rhodium (Rh)	
Crankcase Emission Control	Type (ventilates to atmosphere, induction system, other)		Induction System
	Energy source (manifold vacuum, carburetor, other)		Manifold Vacuum
	Discharges to (intake manifold, other)		Intake Manifold
	Air inlet (breather cap, other)		Air Cleaner Outlet Duct
Evaporative Emission Control	Vapor vented to (crankcase, canister, other)	Fuel tank	Canister
		Carburetor	-
	Vapor storage provision		Canister
Electronic System	Closed loop (yes/no)		Yes
	Open loop (yes/no)		No

## Engine - Exhaust System

Type (single, single with cross-over, dual, other)		Single
Muffler no. & type (reverse flow, straight thru, separate resonator) Material & Mass kg (wght/lbs.)		1, Triflow. Muffler, Stainless Steel, 6.5 (14.4)
Resonator no. & type		Not Applicable
Exhaust pipe	Branch o.d., wall thickness	"
	Main o.d., wall thickness	50.8 x 1.77 mm (2.0 x .070 in.)
	Matl. & Mass kg (wght/lbs.)	409 Stainless Steel, 3.4 (7.6)
Inter-mediate pipe	o.d. & wall thickness	50.8 x 1.09 mm (2.0 x .043 in.)
	Matl. & Mass kg (wght/lbs.)	409 Stainless Steel, 3.0 (6.7)
Tail pipe	o.d. & wall thickness	50.8 x 1.09 mm (2.0 x .043 in.)
	Matl. & Mass kg (wght/lbs.)	409 Stainless Steel, .4 (.9)

# MVMA Specifications

Vehicle Line BERETTA  
 Model Year 1993 Issued 9-92 Revised(\*)

METRIC (U.S. Customary)

Engine Description  
 Engine Code

3.1 LITER V6 (191 CID)  
 MULTI-PORT FUEL INJECTION RPO LHO

## Vehicle Emission Control

Manual Transmission

Automatic Transmission

Type (air injection, engine modifications, other)		Not Applicable	Not Applicable
Air injection	Pump or pulse	"	"
	Driven by	"	"
	Air distribution (head, manifold, etc.,)	"	"
	Point of entry	"	"
Exhaust Gas Recirculation	Type (controlled flow, open orifice, other)	3 Sized Orifices Which Are Opened Or Closed Using, Pintles And Solenoids. 8 Flow Combination.	
	Exhaust source Point of exh.inj. (spacer, carb., manifold, other)	Plenum, Near Throttle Body	
Catalytic Converter	Type	Bed Monolith (Dual)	
	Number of	1	
	Location(s)	Mounted To Underbody	
	Volume L (cu.in)	2.79 (170)	
	Substrate type	Ceramic Monolith	
	Noble metal type	Platinum (Pt), Rhodium (Rh)	
Crankcase Emission Control	Type (ventilates to atmosphere, induction system, other)	Closed Induction System	
	Energy source (manifold vacuum, carburetor, other)	Plenum Vacuum	
	Discharges to (intake manifold, other)	Discharges To Plenum	
	Air inlet (breather cap, other)	Duct Between Air Cleaner And Throttle Body	
Evaporative Emission Control	Vapor vented to (crankcase, canister, other)	Fuel tank	Fuel Tank To Canister To Throttle Body Port
		Carburetor	Not Applicable
	Vapor storage provision	Canister	
Electronic System	Closed loop (yes/no)	Yes	
	Open loop (yes/no)	No	

## Engine - Exhaust System

Type (single, single with cross-over, dual, other)	Single	
Muffler no. & type (reverse flow, straight thru, separate resonator) Material & Mass kg (weight lbs.)	1, Triflow Muffler, Stainless Steel, 6.5 (14.4)	
Resonator no. & type	Not Applicable	
Exhaust pipe	Branch o.d., wall thickness	"
	Main o.d., wall thickness	50.8 x 1.77 mm (2.0 x .070 in.)
	Matl. & Mass kg (wght.lbs.)	409 Stainless Steel, 1.9 (4.2)
Inter-mediate pipe	o.d. & wall thickness	50.8 x 1.09 mm (2.0 x .043 in.)
	Matl. & Mass kg (wght.lbs.)	409 Stainless Steel, 3.0 (6.7)
Tail pipe	o.d. & wall thickness	50.8 x 1.09 mm (2.0 x .043 in.)*
	Matl. & Mass kg (wght.lbs.)	409 Stainless Steel, .8 (1.8); W/221 1.0 (2.2)

\* W/221 57.1 x 1.09 mm (2.2 x .043 in.)

# MVMA Specifications

Vehicle Line BERETTA  
 Model Year 1993 Issued 9-92 Revised(\*) \_\_\_\_\_

## METRIC (U.S. Customary)

Engine Description

2.3 LITER L4 (138 CID)

Engine Code

MULTI-PORT FUEL INJECTION RPO LG0

## Vehicle Emission Control

Exhaust Emission Control	Type (air injection, engine modifications, other)		C3 Engine Modification
	Air injection	Pump or pulse	None
		Driven by	
		Air distribution (head, manifold, etc.)	
		Point of entry	
	Exhaust Gas Recirculation	Type (controlled flow, open orifice, other)	California Only - Controlled Flow Dual None/Orifice Digital EGR Valve
		Exhaust source	
		Point of exh.inj. (spacer, carb., manifold, other)	Intake Manifold
	Catalytic Converter	Type	Single Bed
		Number of	1
Location(s)		Under Floor	
Volume L (cu.in)		2.671 (163)	
Substrate type		Monolith - Ceramic	
Noble metal type		Platinum (Pt), Paladium (Pd), Rhodium (Rh)	
Crankcase Emission Control	Type (ventilates to atmosphere, induction system, other)		Orifice + Bypass. No PCV Valve. Closed - Ventilates To Induction System.
	Energy source (manifold vacuum, carburetor, other)		Orificed Connection To Manifold Vacuum. Open Hose Connection To Clean Side Of A/C.
	Discharges to (intake manifold, other)		Induction System
	Air inlt(breather cap, other)		None
Evaporative Emission Control	Vapor vented to (crankcase, canister, other)	Fuel tank	Canister
		Carburetor	None
	Vapor storage provision		Charcoal Canister
Electronic System	Closed loop (yes/no)		Yes
	Open loop (yes/no)		No

## Engine - Exhaust System

Type (single, single with cross-over, dual, other)		Single
Muffler no. & type (reverse flow, straight thru, separate resonator) Material & Mass kg (weight lbs.)		1, Triflow Muffler, Stainless Steel, 7.5 (16.7)
Resonator no. & type		1, 63 mm O.D. "Bottle" Resonator
Exhaust pipe	Branch o.d., wall thickness	44.5 x 1.9 mm (1.75 x .075 in.)
	Main o.d., wall thickness	44.5 x 1.0 mm (1.75 x .040 in.)
	Matl. & Mass kg (wght.lbs.)	409 Stainless Steel, 1.73 (3.81)
Inter-mediate pipe	o.d. & wall thickness	50.8 x 1.89 mm (2.0 x .074 in.)
	Matl. & Mass kg (wght.lbs.)	409 Stainless Steel, 5.0 (11.1)
Tail pipe	o.d. & wall thickness	76.0 x .86 mm (3.0 x .034 in.)
	Matl. & Mass kg (wght.lbs.)	304 Stainless Steel, 1.8 (4.0)

# MVMA Specifications

Vehicle Line BERETTA  
 Model Year 1993 Issued 9-92 Revised \_\_\_\_\_

## METRIC (U.S. Customary)

Engine Description  
 Engine Code

2.2 LITER L4 (133 CID)  
 MULTI-PORT FUEL INJECTION RPO LN2

## Transmissions/Transaxle (Std., Opt., N.A.)

Manual 4-speed (manufacturer/country)	Not Applicable
Manual 5-speed (manufacturer/country)	Standard Isuzu / Japan (MR3)
Manual 6-speed (manufacturer/country)	Not Applicable
Automatic (manufacturer/country)	Optional, General Motors Powertrain / U.S.A.
Auto. overdrive (manufacturer/country)	Not Applicable

## Manual Transmission/Transaxle

Number of forward speeds	5	
Gear ratios	1st	3.73
	2nd	2.15
	3rd	1.33
	4th	.923
	5th	0.74
	6th	
	Reverse	3.56
Synchronous meshing (specify gears)	1-5	
Shift lever location	Floor	
Trans. case mat'l. & mass kg (lbs)*	Aluminum, 36.5 (80.1)	
Lubricant	Capacity L (pt.)	1.9 (4.0)
	Type recommended	Synchromesh Transmission Fluid (STF)

## Clutch (Manual Transmission)

Clutch manufacturer	Daikin	
Clutch type (dry, wet; single, multiple disc)	Dry Disc, Single	
Linkage (hyd., cable, rod, lever, other)	Hydraulic	
Max. pedal effort (nom. spring load) N (lbs.)	Depressed	133.4 (30.0)
	Released	115.6 (26.0)
Assist (spring, power/percent, nominal)	None	
Type pressure plate springs	Diaphragm	
Total spring load (nominal) N (lbs)	5688 (1279)	
Clutch facing	Facing mfr. & mat'l. coding	Valeo F202
	Facing mat'l. & construction	f202
	Rivets per facing	16
	Outside x inside dia. (nom.)	215.0 x 150.0 (8.46 x 5.91)
	Total eff. area sq cm (sq in)	186.3 (28.88)
	Thickness (pressure plate side/fly wheel side)	3.5 (.14) Pressure Plate Side, 3.2 (.13) Flywheel Side
	Rivet depth (pressure plate side/fly wheel side)	1.3 (0.05) / 1.2 (0.05)
Engagement cushion method	Driven Plate, Wave Spoke Springs	
Release bearing type & method lub.	Self Centering, Angular Contact Ball Bearing - Prepacked & Sealed	
Torsional damping method, springs, hysteresis	Coil Springs With Non-Metal Friction Control	

\* Includes shift linkage, lubricant, and clutch housing. If other specify.

# MVMA Specifications

Vehicle Line BERETTA  
 Model Year 1993 Issued 9-92 Revised \_\_\_\_\_

## METRIC (U.S. Customary)

Engine Description 3.1 LITER V6 (191 CID)  
 Engine Code MULTI-PORT FUEL INJECTION RPO LHO

## Transmissions/Transaxle (Std., Opt., N.A.)

Manual 4-speed (manufacturer/country)	
Manual 5-speed (manufacturer/country)	Standard - N. Venture/U.S.A. (MG2)
Manual 6-speed (manufacturer/country)	
Automatic (manufacturer/country)	Optional - Hydra-matic, U.S.A. (MD9)
Auto. overdrive (manufacturer/country)	

## Manual Transmission/Transaxle

Number of forward speeds		5
Gear ratios	1st	3.50
	2nd	2.05
	3rd	1.38
	4th	0.94
	5th	0.72
	6th	
	Reverse	3.41
Synchronous meshing (specify gears)		1, 2, 3, 4 and 5
Shift lever location		Floor Mount
Trans. case mat'l. & mass kg (lbs)*		Aluminum, 41.0 (90.2)
Lubricant	Capacity L (pt.)	1.9 (4.01)
	Type recommended	Synchromesh Transmission Fluid (STF)

## Clutch (Manual Transmission)

Clutch manufacturer		LUK
Clutch type (dry, wet; single, multiple disc)		Dry Single Disc
Linkage (hyd., cable, rod, lever, other)		Hydraulic
Max. pedal effort (nom. spring load) N (lbs.)	Depressed	133.4 (30.0)
	Released	133.4 (30.0)
Assist (spring, power/percent, nominal)		Not Applicable
Type pressure plate springs		Diaphragm
Total spring load (nominal) N (lbs)		6540 (1470)
Clutch facing	Facing mfr. & matl. coding	LUK
	Facing matl. & construction	Non-Asbestos
	Rivets per facing	32
	Outside x inside dia. (nom.)	232 x 156 mm (9.12 x 6.12 in.)
	Total eff. area sq cm (sq in)	232 (35.90)
	Thickness (pressure plate side/fly wheel side)	7.50 - 8.00 mm (.295 - .315 in.)
	Rivet depth (pressure plate side/fly wheel side)	1.4 mm (0.06 in.) / 1.4 mm (0.06 in.)
Engagement cushion method		Cushion Springs
Release bearing type & method lub.		Self Centering, Angular Contact Ball Bearing Pre-Packed & Sealed
Torsional damping method, springs, hysteresis		Coil Springs With Non-Metal Friction Control

\* Includes shift linkage, lubricant, and clutch housing. If other specify.

# MVMA Specifications

Vehicle Line BERETTA  
 Model Year 1993 Issued 9-92 Revised \_\_\_\_\_

## METRIC (U.S. Customary)

Engine Description  
 Engine Code

2.3 LITER L4 (138 CID)  
 MULTI-PORT FUEL INJECTION RPO LGO

## Transmissions/Transaxle (Std., Opt., N.A.)

Manual 4-speed (manufacturer/country)	
Manual 5-speed (manufacturer/country)	
Manual 6-speed (manufacturer/country)	
Automatic (manufacturer/country)	Not Applicable
Auto. overdrive (manufacturer/country)	

## Manual Transmission/Transaxle

Number of forward speeds		5
Gear ratios	1st	3.50
	2nd	2.05
	3rd	1.38
	4th	1.03
	5th	.72
	6th	
	Reverse	3.41
Synchronous meshing (specify gears)		All Forward Gears
Shift lever location		Floor - Console
Trans. case mat'l. & mass kg (lbs)*		Aluminum, 30.314 (13.75)
Lubricant	Capacity L (pt.)	1.9 (4.0)
	Type recommended	Standard Transmission Fluid (STF)

## Clutch (Manual Transmission)

Clutch manufacturer		Daikin
Clutch type (dry, wet; single, multiple disc)		Dry, Single
Linkage (hyd., cable, rod, lever, other)		Hydraulic
Max. pedal effort (nom. spring load) N (lbs.)	Depressed	151 (34)
	Released	0 (0)
Assist (spring, power/percent, nominal)		None
Type pressure plate springs		Belleville Spring
Total spring load (nominal) N (lbs)		5892 (1325)
Clutch facing	Facing mfr. & mat'l. coding	Daikin NC80
	Facing mat'l. & construction	NC80
	Rivets per facing	16
	Outside x inside dia. (nom.)	232 x 150 mm (9.13 x 5.91 in.)
	Total eff. area sq cm (sq in)	442 (68.5)
	Thickness (pressure plate side/fly wheel side)	3.2 (.126) Pressure Plate, 3.5 (.138) Fly Wheel
	Rivet depth (pressure plate side/fly wheel side)	1.6 (.06) Pressure Plate, 1.5 (.06) Fly Wheel
Engagement cushion method		Driven Plate Cushion
Release bearing type & method lub.		Ball Thrust - Prepacked & Sealed
Torsional damping method, springs, hysteresis		Coil Spring With Friction Washer

\* Includes shift linkage, lubricant, and clutch housing. If other specify.

# MVMA Specifications

Vehicle Line BERETTA  
 Model Year 1993 Issued 9-92 Revised \_\_\_\_\_

## METRIC (U.S. Customary)

Engine Description 2.2 LITER L4 (133 CID)  
 Engine Code MULTI-PORT FUEL INJECTION RPO LN2

### Automatic Transmission/Transaxle

Trade Name		3T40 Transaxle Assembly
Type and special features (describe)		3-Speed Automatic, Fully Automatic Shifted Planetary Gear W/Torque Converter And Lock-Up Clutch
O Shift mechanics		
Gear selector	Location (column, floor, other)	Floor
	Ltr./No. designation (e.g. PRND21)	P-R-N-D-2-1
	Shift interlock (yes, no, describe)	No
Gear ratios	1st	2.84
	2nd	1.60
	3rd	1.00 (Converter Clutch Engagement)
	4th	Not Applicable
	5th	"
	6th	"
	Reverse	2.07
Final drive ratio		
Max. upshift vehicle speed - drive range km/h (mph)		2 - 3 = 130 (81)
O Max. upshift engine speed RPM		
Max. kickdown speed - drive range km/h (mph)		3 - 2 = 124 (77)
Min. overdrive speed km/h (mph)		---
O Torque converter		
Torque converter	Type	
	Torus design	
	Number of elements	3
	Max. ratio at stall	2.48
	Type of cooling (air, liquid)	Liquid
	Nominal diameter	245 (9.8)
Capacity factor "K" <sup>2</sup>	203	
O Pump type		
Lubricant	Capacity refill L (pt.)	8.5 (17.85) Dry Transmission, Original Filling
	Type recommended	Dexron II
Oil cooler (std., opt., N.A., internal, external, air, liquid)		Standard, Integral Part Of Radiator
Trans. mass kg (lbs) & case matl.**		65.7 (144.54), Dry Weight

### All Wheel / 4 Wheel Drive

(NOT APPLICABLE)

Desc. & type (part-time, full-time, 2/4 shift while moving, mech., elect., chain/gear, etc.)		
Transfer	Manufacturer and model	
	Type and location	
Low-range gear ratio		
System disconnect (describe)		
Center differential	Type (bevel, planetary, w or w/o viscous bias, torsen, etc.)	
	Torque split(% frt/rear)	

\* Input speed / square root of torque.  
 \*\* Dry weight including torque converter. If other, specify.



# MVMA Specifications

Vehicle Line BERETTA  
 Model Year 1993 Issued 9-92 Revised \_\_\_\_\_

METRIC (U.S. Customary)

Engine Description **3.1 LITER V6 (191 CID)**  
 Engine Code **MULTI-PORT FUEL INJECTION RPO LHO**

## Automatic Transmission/Transaxle

Trade Name	3T40 Transaxle Assembly	
Type and special features (describe)	3-Speed Automatic, Fully Automatic Shifted Planetary Gear W/Torque Converter And Lock-Up Clutch	
O Shift mechanics		
Gear selector	Location (column, floor, other)	Column & Floor
	Ltr./No. designation (e.g. PRND21)	P-R-N-D-2-1
	Shift interlock (yes, no, describe)	No
Gear ratios	1st	2.84
	2nd	1.60
	3rd	1.00 (Converter Clutch Engagement)
	4th	Not Applicable
	5th	"
	6th	"
	Reverse	2.07
O Final drive ratio		
Max. upshift vehicle speed - drive range km/h (mph)	2 - 3 = 130 (81) 2.84 Ratio	145 (90) 2.53 Ratio
O Max. upshift engine speed RPM		
Max. kickdown speed - drive range km/h (mph)	3 - 2 = 126 (78)	138 (86)
O Min. overdrive speed km/h (mph)		
O Torque converter		
Torque converter	Type	
	Torus design	
	Number of elements	3
	Max. ratio at stall	2.35
	Type of cooling (air, liquid)	Liquid
	Nominal diameter	245 (9.8)
Capacity factor "K"	177	
O Pump type		
Lubricant	Capacity refill L (pt.)	8.5 (17.85) Dry Transmission, Original Filling
	Type recommended	Dexron II
Oil cooler (std., opt., N.A., internal, external, air, liquid)	Standard, Integral Part Of Radiator	
Trans. mass kg (lbs) & case matl.**	65.7 (144.54) Dry Weight	

## All Wheel / 4 Wheel Drive (NOT APPLICABLE)

Desc. & type (part-time, full-time, 2/4 shift while moving, mech., elect., chain/gear, etc.)		
Transfer	Manufacturer and model	
	Type and location	
Low-range gear ratio		
System disconnect (describe)		
Center differential	Type (bevel, planetary, w or w/o viscous bias, torsen, etc.)	
	Torque split(% frt/rear)	

\* Input speed / square root of torque.  
 \*\* Dry weight including torque converter. If other, specify.

# MVMA Specifications

Vehicle Line BERETTA  
 Model Year 1993 Issued 9-92 Revised \_\_\_\_\_

## METRIC (U.S. Customary)

Engine Description	2.2 LITER L4 (133 CID)
Engine Code	MULTI-PORT FUEL INJECTION RPO LN2

## Axle Ratio and Tooth Combinations

		AUTOMATIC - MD9	MANUAL - MR3
Effective final drive ratio (or overall top gear ratio)		3.18	3.83 (2.83)
Transr ratio and method(chain,gear,etc)		1.12, Chain	Not Applicable
Front drive unit	Ring gear o.d.	Not Applicable	"
	No. of teeth	Pinion	"
		Ring gear	"

## Front Drive Unit

Description (integral to trans., etc.)		Planetary Final Drive Integral With Transmission
Limited slip differential(type)		Not Applicable
Drive pinion	Type	"
	Offset	"
No. of differential pinions		2
Pinion/differential	Adjustment (shim, etc.)	Not Applicable
	Bearing adjustment	"
Driving wheel bearing (type)		
Lubricant	Capacity L (pt.)	See Automatic Trans Spec
	Type recommended	"

## Axle Shafts - Front Wheel Drive

Manufacturer and number used		Saginaw Division, 2		
Type (straight, solid bar, tubular, etc.)	Left	Straight, Solid Bar		
	Right	Straight, Solid Bar		
Outer diam. x length* x wall thickness	Manual transaxle	Left	23.81 x 320.0 mm	
		Right	23.81 x 663.0 mm	
	Automatic transaxle	Left	23.81 x 311.0 mm	
		Right	23.81 x 364.3 mm	
	Optional transaxle	Left	None	
		Right	None	
Slip yoke	Type	None		
	Number of teeth	None		
	Spline o.d.	None		
Universal joints	Make and mfg. no.	Inner	Saginaw Division	
		Outer	Saginaw Division	
	Number used		2 On Each Drive Shaft	
	Type, size, plunge	Inner	Triplot 61.0 Stroke	
		Outer	Rzeppa - Fixed Center	
	Attach (u-bolt, clamp, etc.)		Splined	
Bearing	Type (plain, anti-friction)	Inner, Ball & Roller; Outer, Ball		
	Lubrication (fitting, prepack)	Prepacked		
Drive taken through (torque tube, arms or springs)		Wishbone Lower Control Arm; Upper MacPherson Strut		
Torque taken through (torque tube, arms or springs)		Engine Mounting System		

\* Centerline to centerline of universal joints, or to centerline of attachment.

# MVMA Specifications

Vehicle Line BERETTA  
 Model Year 1993 Issued 9-92 Revised(\*)           

## METRIC (U.S. Customary)

Engine Description 3.1 LITER V6 (191 CID)  
 Engine Code MULTI-PORT FUEL INJECTION RPO LHO

Axle Ratio and Tooth Combinations		AUTOMATIC - MD9	MANUAL - MG2
Effective final drive ratio (or overall top gear ratio)		2.53 & 2.84	3.61 (2.60)
Transr ratio and method(chain, gear, etc)		1.00, Chain	Not Applicable
Front drive unit	Ring gear o.d.	Not Applicable	"
	No. of teeth	"	"
	Pinion	"	"
	Ring gear	"	"

## Front Drive Unit

Description (integral to trans., etc.)		Planetary Final Drive Integral With Transmission
Limited slip differential (type)		Not Applicable
Drive pinion	Type	"
	Offset	"
No. of differential pinions		2
Pinion/differential	Adjustment (shim, etc.)	Not Applicable
	Bearing adjustment	"
Driving wheel bearing (type)		See Automatic Trans Spec
Lubricant	Capacity L (pt.)	"
	Type recommended	"

## Axle Shafts - Front Wheel Drive

Manufacturer and number used		2		
Type (straight, solid bar, tubular, etc.)	Left	Straight Solid Bar		
	Right	Straight Solid Bar		
Outer diam. x length* x wall thickness	Manual transaxle	Left	27.05 X 308.0 mm	
		Right	27.05 x 315.5 mm	
	Automatic transaxle	Left	23.81 X 304.6 mm	
		Right	23.81 X 365.4 mm	
	Optional transaxle	Left	None	
		Right	None	
Slip yoke	Type	None		
	Number of teeth	None		
	Spline o.d.	None		
Universal joints	Make and mfg. no.	Inner	Saginaw Division	
		Outer	Saginaw Division	
	Number used	2 On Each Drive Shaft		
	Type, size, plunge	Inner	FREE MOTION 61.0 Stroke	Cross-Groove 61.2 Stroke
		Outer	Rzeppa - Fixed Center	
	Attach (u-bolt, clamp, etc.)		Splined	
	Bearing	Type (plain, anti-friction)	Inner - Ball & Roller	Inner - Ball
Lubrication (fitting, prepack)		Outer - Ball	Outer - Ball	
Drive taken through (torque tube, arms or springs)		Prepacked		
Drive taken through (torque tube, arms or springs)		Wishbone Lower Control Arm; Upper MacPherson Strut		
Torque taken through (torque tube, arms or springs)		Engine Mounting System		

\* Centerline to centerline of universal joints, or to centerline of attachment.

# MVMA Specifications

Vehicle Line BERETTA  
 Model Year 1993 Issued 9-92 Revised \_\_\_\_\_

## METRIC (U.S. Customary)

<b>Engine Description</b>	2.3 LITER L4 (138 CID)
<b>Engine Code</b>	MULTI-PORT FUEL INJECTION RPO LGO

### Axle Ratio and Tooth Combinations **MANUAL - MV5 (Does Not Come With Base)**

Effective final drive ratio (or overall top gear ratio)		3.94	
Transfr ratio and method(chain,gear,etc)		Gear	
Front drive unit	Ring gear o.d.	202 (8.0)	
	No. of teeth	Pinion	18
		Ring gear	65

### Front Drive Unit

Description (integral to trans., etc.)		Planetary Final Drive Integral With Transmission
Limited slip differential (type)		Not Applicable
Drive pinion	Type	"
	Offset	"
No. of differential pinions		2
Pinion/differential	Adjustment (shim, etc.)	Shim
	Bearing adjustment	Not applicable
Driving wheel bearing (type)		Sealed Ball Bearing (Integral Part Of Bolt In Hub Unit)
Lubricant	Capacity L (pt.)	1.9 (4), Transaxle
	Type recommended	STF

### Axle Shafts - Front Wheel Drive

Manufacturer and number used		2		
Type (straight, solid bar, tubular, etc.)		Left	Straight, Solid Bar	
		Right	Straight, Solid Bar	
Outer diam. x length* x wall thickness	Manual transaxle	Left	27.1 x 308.0 mm	
		Right	27.1 x 315.5 mm	
	Automatic transaxle	Left		
		Right		
	Optional transaxle	Left	None	
		Right	None	
Slip yoke	Type	None		
	Number of teeth	None		
	Spline o.d.	None		
Universal joints	Make and mfg. no.	Inner	Saginaw Division	
		Outer	Saginaw Division	
	Number used	2 On Each Drive Shaft		
	Type, size, plunge	Inner	Cross-Groove 61.2 Stroke	
		Outer	Rzeppa - Fixed Center	
	Attach (u-bolt, clamp, etc.)		Splined	
Bearing	Type (plain, anti-friction)	Inner - Ball Outer - Ball		
	Lubrication (fitting, prepack)	Prepacked		
Drive taken through (torque tube, arms or springs)		Wishbone Lower Control Arm; Upper MacPherson Strut		
Torque taken through (torque tube, arms or springs)		Engine Mounting System		

\* Centerline to centerline of universal joints, or to centerline of attachment.

# MVMA Specifications

METRIC (U.S. Customary)

Vehicle Line BERETTA  
 Model Year 1993 Issued 9-92 Revised(\*)

Model Code/Description And/Or  
 Engine Code/Description

BASE

## Suspension - General Including Electronic Controls

Car leveling	Std./opt./n.a.	--	
	Manual/automatic control	--	
	Type (air/hydraulic)	--	
	Primary/assist spring	--	
	Rear only/4 wheel leveling	--	
	Single/dual rate spring	--	
	Single/dual ride heights	--	
	Provision for jacking	Body Jack & Pads On Rocker	
Shock absorber damping controls	Std./opt./n.a.	--	
	Manual/automatic control	--	
	Number of damping rates	--	
	Type of actuation (manual/electric motor/air, etc.)	--	
	s e n s o r s	Lateral acceleration	--
		Deceleration	--
		Acceleration	--
Road surface		--	
Shock absorber (front & rear)	Type	Front: MacPherson Strut, Rear: Double Acting Hydraulic	
	Make	Delco Products	
	Piston diameter	Front: 32 (1.26) Rear: 32 (1.26)	
	Rod diameter	Front: 22 (.87) Rear: 13 (.51)	

## Suspension - Front

Type and description		MacPherson Strut With Coil Spring
Travel	Full jounce (define load condition)	82 mm (3.23 in.), From Design
	Full rebound	81 mm (3.19 in.), From Design
Spring	Type (coil, leaf, other & matl)	Coil, Steel
	Insulators (type & matl)	Top & Bottom - Rubber
	Size (Leaf: length & width; Coil: design height & i.d.; Bar: length & diameter)	Spring Computer Selected - Varies With Option Content
	Spring rate N/mm (lb./in.)	20 (177)
	Rate @ wheel N/mm (lb./in.)	17.5 (154.9)
Stabilizer	Type (link, linkless, frmlless)	Link
	Material & O.D. bar/tube, wall thickness	Steel, 30 mm (1.18 in.)

## Suspension - Rear

Type and description		Trailing Twist Axle With Tubular Control Arms And Open Section Transverse Beam
Travel	Full jounce (define load condition)	100.8 mm (3.97 in.), From Design
	Full rebound	91 mm (3.58 in.), From Design
Spring	Type (coil, leaf, other & matl)	Coil, Steel
	Size (Leaf: length & width; Coil: design height & i.d.; Bar: length & diameter)	Spring Computer Selected - Varies With Option Content
	Spring rate N/mm (lb./in.)	23 (203.6), Variable
	Rate @ wheel N/mm (lb./in.)	11.1 (98.2), Variable
	Insulators (type & material)	Top & Bottom - Rubber
	If leaf	No. of leaves
Shackle (comp or tens)		--
Stabilizer	Type (link, linkless, frmlless)	--
	Material & O.D. bar/tube, wall thickness	--
Track bar (type)		--

# MVMA Specifications

METRIC (U.S. Customary)

Vehicle Line BERETTA  
 Model Year 1993 Issued 9-92 Revised(\*) \_\_\_\_\_

Model Code/Description And/Or  
 Engine Code/Description  
**Brakes - Service**

ALL

Description		Power Assisted Hydraulic Brakes			
Manufacturer and brake type (std., opt., n.a.)	Front (disc or drum)	Standard - Disc			
	Rear (disc or drum)	Standard - Drum			
Valving type(prop.,delay,metering,other)		Proportioning, Diagonal Split Circuit			
Power brake (std., opt., n.a.)		Standard			
Booster type(rmt,intgrl,vac.,hyd.,etc.)		Tandem Vacuum			
Vacuum	Source (inline, pump, etc.)	Inline			
	Reservoir (volume cu. in.)	None			
	Pump-type	Not Applicable			
O Traction assist	Operational speed range	Not Applicable			
	Type (engine or brake intervention)				
Anti-lock device	Front/rear (std., opt., n.a)	Standard			
	Manufacturer	Delco Chassis Division			
	Type (electronic, mech.)	Electronic			
	Number sensors or circuits	4			
	No. anti-lock hyd. circuits	3			
	Integral or add-on system	Add-On			
	Yaw control (yes, no)	Yes			
Hydraulic power source		No			
Effective area sq. cm. (sq. in.)*		204 (31.7) Front	614 (95.2) Rear		
Gross Lng area sq cm (sq in)** (F/R)		204 (31.7) Front	650 (100.8) Rear		
Swept area sq cm (sq in)*** (F/R)		1175 (182.2) Front	556 (86.2) Rear		
Rotor	Outer working diameter	F/R	Front - 259.5(10.2)		
	Inner working diameter	F/R			
	Thickness	F/R	Front - 20 (.79)		
	Matl & type (vented/sld)	F/R	Front - Vented Cast Iron		
Drum	Diameter & width	F/R	Rear - 200 x 45 mm (7.87 x 1.77 in.)		
	Type and material	F/R	Cast Iron		
Wheel cylinder bore		Front - 57 mm (2.24 in.) Rear - 17.5 (.69)			
Master cylinder	Bore/stroke	F/R	Bore - 22.2 mm (.874 in.) Stroke 35.7 mm (1.41 in.)		
Pedal arc ratio		3.35:1			
Line pressure at 445 N (100 lb.) pedal load kPa (psi)		(1,600) Max			
Lining clearance		F/R	Both - Self Adjusting		
Brake lining	Front wheel	Bonded or riveted		Integrally Molded - Inboard And Outboard	
		Rivet size		Not Applicable	
		Manufacturer		Delco Chassis Division	
		Lining code *****		128 FE	
		Material		Semi-Metallic	
		****	Pri. or out-brd	124 x 46 x 8.6 (4.88 x 1.81 x .34)	
		Size	Sec. or in-brd	124 x 46 x 9.7 (4.88 x 1.81 x .38)	
	Shoe thcknss.(no lng)		4.85 (.19)		
	Rear wheel	Bonded or riveted		Riveted	
		Manufacturer		Delco Chassis Division	
		Lining code *****		235 FE	
		Material		Organic	
		****	Pri. or out-brd	167.7 x 43.9 x 6 mm (6.602 x 1.728 x .236 in.)	
		Size	Sec. or in-brd	194 x 43.9 x 7 mm (7.638 x 1.728 x .28 in.)	
Shoe thcknss (no lng)		2.75 mm (.11 in.)			

\* Excludes rivet holes, grooves, chamfers, etc. \*\*Includes rivet holes, grooves, chamfers, etc.  
 \*\*\* Total swept area for four brakes. (Drum brake: Widest lining contact width for each brake x its contact circum.)  
 (Disc brake: Square of Outer Working Dia. - Square of inner Working Dia. X Pi/2 for each brake.)  
 \*\*\*\* Size for drum brakes includes length x width x thickness.  
 \*\*\*\*\* Manufacturer I.D., catalog for formulation designation and coefficient of friction classification.

# MVMA Specifications

Vehicle Line BERETTA  
 Model Year 1993 Issued 9-92 Revised(\*) \_\_\_\_\_

METRIC (U.S. Customary)

Model Code/Description And/Or  
 Engine Code/Description

BASE

## Tires And Wheels (Standard)

O Tires	Size (service description)		P185/75R14 BW
	Type (bias, radial, etc.)		Steel Belted Radial
	Inflation pressure (cold) for recommended max. vehicle load	Front kPa (psi)	210 (30)
		Rear kPa (psi)	210 (30)
Rev/mile—at 70 km/h(45mph)			
O Wheels	Type & material		Steel
	Rim (size & flange type)		14 x 6
	Wheel offset		47 (1.85)
	Attachment	Type (bolt or stud & nut)	Stud
		Circle diameter	100.0 mm (3.94 in.)
Number & size		5-M12 x 1.5 - 6H, THD. (Metric)	
O Spare	Tire and wheel		T115/70D - 14 BW, Wheel Dia. 14 x 4, Inflation 415 (60)
	Storage position & location (describe)		Flat Under Rear Load Floor

## Tires And Wheels (Optional)

O	Tire size (service description)		P195/70R14 BW
	Type (bias, radial, steel, nylon, etc.)		Steel Belted Radial
	Wheel (type & material)		Steel
	Rim (size, flange type and offset)		14 x 6
O	Tire size (service description)		P205/60R15 BW
	Type (bias, radial, steel, nylon, etc.)		Steel Belted Radial
	Wheel (type & material)		Aluminum
	Rim (size, flange type and offset)		15 x 7
O	Tire size (service description)		P205/55VR16 BW
	Type (bias, radial, steel, nylon, etc.)		Steel Belted Radial
	Wheel (type & material)		Aluminum
	Rim (size, flange type and offset)		16 x 7
O	Tire size (service description)		P205/55R16 BW
	Type (bias, radial, steel, nylon, etc.)		Steel Belted Radial
	Wheel (type & material)		Aluminum
	Rim (size, flange type and offset)		16 x 7
Spare tire and wheel size (if configuration is different than road tire or wheel, describe optional spare tire and/or wheel location & storage position)			

## Brakes - Parking

Type of control		Hand Lever Assembly
Location of control		In Console Between Front Seats
Operates on		Rear Service Brakes
If separate from service brakes	Type (internal or external)	--
	Drum diameter	--
	Lining size (length x width x thickness)	--

# MVMA Specifications

Vehicle Line BERETTA  
 Model Year 1993 Issued 9-92 Revised \_\_\_\_\_

METRIC (U.S. Customary)

Model Code/Description And/Or  
 Engine Code/Description

BASE

## Steering

Manual (std., opt., n.a.)		Not Available		
Power (std., opt., n.a.)		Standard		
Speed-sensitive (std., opt., n.a.)		Not Available		
4-wheel steering (std., opt., n.a.)		Not Available		
Adjustable steering wheel/column (tilt, telescope, other)	Type	Tilt		
	Manufacturer	Saginaw Division		
	(std., opt., n.a.)	Optional		
Wheel diameter ** (W9) SAE J1100	Manual	--		
	Power	386 (15.2)		
Turning diameter m (ft.)	Out-side front	Wall to wall (l. & r.)	11.3 (37.2)	
		Curb to curb (l. & r.)	10.75 (35.3)	
	In-side rear	Wall to wall (l. & r.)	5.8 (19.2)	
		Curb to curb (l. & r.)	7.5 (24.6)	
Scrub Radius *		-1.69 (14" Tires)		
Manual	Gear	Type	--	
		Manufacturer	--	
		Ratios	Gear -- Overall --	
	No. wheel turns(stop to stop)		--	
	Type (coaxial, elec. hyd., etc.)		Rack And Pinion W/Center Take-Off Tie Rods - Integral	
Power	Manufacturer		Saginaw Division	
	Gear	Type	Rack And Pinion W/Center Take-Off Tie Rods - Integral	
		Ratios	Gear -- Overall 16.12:1	
		Pump (drive)		Belt Off Crankshaft Pulley
	No. wheel turns(stop to stop)		2.88	
Linkage	Type		Center Take Off Tie Rods, Rack And Pinion	
	Location (front or rear of wheels, other)		Rear	
	Tie Rods (one or two)		2	
Steering axis	Inclination at camber (deg.)		13.2	
	Bear-ings (type)	Upper	Ball Bearings	
		Lower	Ball Joint	
		Thrust	Incorporated In Upper Bearing	
Steering spindle/knuckle & joint type		MacPherson Strut		

\* The horizontal distance in the front elevation between wheel centerline and kingpin (ball joint) axis at ground.  
 \*\* See Page 22.



# MVMA Specifications

METRIC (U.S. Customary)

Vehicle Line BERETTA  
 Model Year 1993 Issued 9-92 Revised(\*) \_\_\_\_\_

Model Code/Description And/Or  
 Engine Code/Description

BASE

## Wheel Alignment

Front wheel at curb mass (wt.)	Service checking	Caster (deg.)	Not Adjustable
		Camber (deg.)	0 (+/-) .7
		Toe-in outside track - mm (in.)	0 (+/-) .10
	Service reset*	Caster (deg.)	Not Adjustable
		Camber (deg.)	0 (+/-) .7
		Toe-in - mm(in.)	0 (+/-) .10
	Periodic M.V. inspection	Caster (deg.)	Not Adjustable
		Camber (deg.)	---
		Toe-in - mm(in.)	---
Rear wheel at curb mass (wt.)	Service checking	Camber (deg.)	Not Applicable
		Toe-in outside track - mm (in.)	"
	Service reset*	Camber (deg.)	"
		Toe-in - mm(in.)	"
	Periodic M.V. inspection	Camber (deg.)	"
		Toe-in - mm(in.)	"

\* Indicates pre-set, adjustable, trend set or other.

## Electrical - Instruments and Equipment

		ELECTRIC BASE CLUSTER	OPTIONAL ELECTRIC CLUSTER
Speedometer	Type (analog, digital, std., opt.)	Analog	
	Trip odometer (std., opt., n.a.)	Not Available	Standard
Head-up display	Std., opt., not avail.	Not Available	
	Type - Secondary, Opto-electronic	"	
	Speedometer	Digital	"
	Status/warn. indicators - Turn signals, high beam, low fuel, check gauges	"	
	Brightness control	Day/night mode, adj.	"
EGR maintenance indicator		Not Available	
Charge indicator	Type	Tell-Tale Warning Light	Gauge
	Warning device (light, audible)	Light	Not Available
Temperature indicator	Type	Gauge	
	Warning device	Tell-Tale Warning Light	
Oil pressure indicator	Type	Tell-Tale Warning Light	Gauge
	Warning device	Light	
Fuel indicator	Type	Electric Gauge W/Pointer	
	Warning device	Not Available	
Windshield wiper	Type (standard)	Electric 2-Speed	
	Type (optional)	Intermittent Windshield Wiper Sys.	
	Blade length	482.6 mm (19.0 in.)	
	Swept area sq cm (sq in)	6221.9 (964.4)	
Windshield washer	Type (standard)	Wet-Arm Electric Pump Mounted On Reservoir Bottle	
	Type (optional)	Not Available	
	Fluid level indicator	"	
Rear window wiper, wiper/washer (std., opt., n.a.)		"	
Horn	Type	Electric Vibrating	
	Number used	Two ('A' And 'F' Notes)	
Other	Headlamp-on Warning	Standard, Chimes	

# MVMA Specifications

Vehicle Line BERETTA  
 Model Year 1993 Issued 9-92 Revised \_\_\_\_\_

## METRIC (U.S. Customary)

Engine Code/Description

2.2 LITER L4 (133 CID)  
 MULTI-PORT FUEL INJECTION RPO LN2

### Electrical - Supply System

Battery	Manufacturer	Delco Remy	
	Model, std., (opt.)	1982514	1983646, Opt.
	Voltage	12	
	Amps at 0 deg F cold crnk	525	600
	Minutes-reserve capacity	90	
	Amps/hrs. - 20 hr. rate	54	
	Location	Engine Compartment	
Alternator	Manufacturer	Delco Remy	
	Rating (idle/max. rpm)	42/105	
	Ratio (alt. crank/rev.)	2.64:1	
	Output at idle (rpm, park)	42 Amps @ 27 Deg. C. 600 RPM	
	Optional (type & rating)		
Regulator	Type	Integral With Alternator	

### Electrical - Starting System

Motor	Manufacturer	Delco Remy	
	Curr.dr. -29 (-20) deg C (F)	329 Amps	
	Power rating kw (hp)	1.4 (1.9)	
Motor drive	Engagement type	Solenoid Operated Shift Lever	
	Pinion engages from (front, rear)	Front	

### Electrical - Ignition System

Type	Electronic (std., opt., n.a.)	Electronic Direct Ignition (Std.) - Control Module With Two Integral Coils And One Remote Timing Sensor		
	Other (specify)	--		
Coil	Manufacturer	Delco Remy		
	Model	1103902		
	Current	Engine stopped-A	Less Than 100 ma	
		Engine idling - A	Less Than 1.5 Amp (Average)	
Spark plug	Manufacturer	AC Spark Plug		
	Model	R44LTSMA		
	Thread (mm)	14 x 1.25		
	Tightening torque Newton meters (lb. ft.)	10-20 (7-15)		
	Gap	1.14 (0.045)		
	Number per cylinder	1		
Distributor	Manufacturer	Not Applicable		
	Model	"		

### Electrical - Suppression

Locations & type	Not Available
------------------	---------------

# MVMA Specifications

Vehicle Line BERETTA  
 Model Year 1993 Issued 9-92 Revised \_\_\_\_\_

METRIC (U.S. Customary)

Engine Code/Description

3.1 LITER V6 (191 CID)  
 MULTI-PORT FUEL INJECTION RPO LHO

## Electrical - Supply System

Battery	Manufacturer	Delco Remy
	Model, std., (opt.)	1982514 Std. 1983646 Opt.
	Voltage	12
	Amps at 0 deg F cold crnk	525 600
	Minutes-reserve capacity	80
	Amps/hrs. - 20 hr. rate	54
	Location	Engine Compartment
Alternator	Manufacturer	Delco Remy
	Rating (idle/max. rpm)	36/100
	Ratio (alt. crank/rev.)	2.65
	Output at idle (rpm, park)	66 Amps @ 27 Deg. C. 850 RPM
Regulator	Type	Integral With Alternator
	Optional (type & rating)	

## Electrical - Starting System

Motor	Manufacturer	Delco Remy
	Curr.dr. -29 (-20) deg C (F)	350 Amps
	Power rating kw (hp)	1.4 (1.9)
Motor drive	Engagement type	Solenoid Operated Shift Lever
	Pinion engages from (front, rear)	Front

## Electrical - Ignition System

Type	Electronic (std., opt., n.a.)	Electronic Direct Ignition (Std.) - Control Module With Three Integral Coils And One Remote Timing Sensor	
	Other (specify)	--	
Coil	Manufacturer	Delco Remy	
	Model	1103759	
	Current	Engine stopped-A	Less Than 100 ma
		Engine idling - A	Less Than 1.5 Amp (Average)
Spark plug	Manufacturer	AC/Rochester Products	
	Model	R44LTSM	
	Thread (mm)	14 x 1.25	
	Tightening torque Newton meters (lb. ft.)	9-20 (7-15)	
	Gap	1.14 (0.045)	
	Number per cylinder	1	
Distributor	Manufacturer	Not Applicable	
	Model	"	

## Electrical - Suppression

Locations & type	Not Available
------------------	---------------

# MVMA Specifications

Vehicle Line BERETTA  
 Model Year 1993 Issued 9-92 Revised(\*)         

## METRIC (U.S. Customary)

Engine Code/Description

2.3 LITER L4 (138 CID)  
 MULTI-PORT FUEL INJECTION RPO LGO

### Electrical - Supply System

Battery	Manufacturer	Delco Remy
	Model, std., (opt.)	Standard
	Voltage	12
	Amps at 0 deg F cold crnk	600
	Minutes-reserve capacity	90
	Amps/hrs. - 20 hr. rate	54
	Location	Engine Compartment
Alternator	Manufacturer	Delco Remy
	Rating (idle/max. rpm)	36/100
	Ratio (alt. crank/rev.)	2.08
	Output at idle (rpm, park)	68 Amps @ 27 Deg. C. 900 RPM
	Optional (type & rating)	None
Regulator	Type	Integral With Alternator

### Electrical - Starting System

Motor	Manufacturer	Delco Remy
	Curr.dr. -29 (-20) deg.C(F)	378 Amps
	Power rating kw (hp)	1.5 kw
Motor drive	Engagement type	Solenoid With Postive Shift
	Pinion engages from (front, rear)	Front

### Electrical - Ignition System

Type	Electronic (std, opt,n.a.)	Standard/Direct Ignition System	
	Other (specify)	Composite Unit W/2 Coils & Elect. Cnt.	
Coil	Manufacturer	Delco Remy (2)	
	Model		
	Current	Engine stopped-A	300 MA
		Engine idling - A	Peak 8.25 Amps
Spark plug	Manufacturer	A/C Spark Plug	
	Model	.FR2LSK	
	Thread (mm)	14 x 1.25	
	Tightening torque Newton meters (lb. ft.)	21 - 24 (15 - 18)	
	Gap	.889 mm (.035 in.)	
	Number per cylinder	1	
Distributor	Manufacturer	Not Applicable	
	Model	"	

### Electrical - Suppression

Locations & type	Not Available
------------------	---------------

# MVMA Specifications

Vehicle Line BERETTA  
 Model Year 1993 Issued 9-92 Revised \_\_\_\_\_

## METRIC (U.S. Customary)

Model Code/Description

BASE

### Body

Structure	Unitized Body Construction Including Front End Structure With Bolted-On Fenders And Hood.
Bumper system front - rear	Bumper Fascias Are Attached To Steel Impact Bar And Dual Energy Absorbers For Collision Energy Absorption. (Meets G.M. 5 mph Impact Standard)
Anti-corrosion treatment	Special Anti-Corrosion Materials Are Used On Interior And Exterior Metal Panel Surfaces. Materials Include One And Two-Sided Galvanized Steel, Special Metal Conditioners, Primers, And Sealers. Protective Moldings Are Applied To Exterior Lower Body.

### Body - Miscellaneous Information

Type of finish (lacquer, enamel, other)	High Solids Basecoat/Clearcoat Enamel		
Hood	Material & mass	Two Sided Galvanized Steel, 17.91 kg. (39.5 lbs.)	
	Hinge location (front, rear)	Rear	
	Type (counterbalance, prop)	Prop	
	Release control (int., ext.)	Internal	
Trunk lid	Material & mass	Two Sided Galvanized Steel, 10.6 kg. (23.4 lbs.)	
	Type (counterbalance, other)	Torsion Rods	
	Internal release control (elec., mech., n.a.)	Electrical - Optional	
Hatch-back lid	Material & mass	Not Applicable	
	Type (counterbalance, other)	"	
	Internal release control (elec., mech., n.a.)	"	
Tailgate	Material & mass	"	
	Type (drop, lift, door)	"	
	Internal release control (elec., mech., n.a.)	"	
Vent window control (crank, friction, pivot, power)	Front	None	
	Rear	"	
Window regulator type (cable, tape, flex drive, etc.)	Front	Not Applicable	Elec. Pinion Gear & Sector Arm
	Rear	"	Elec. Pinion Gear & Sector Arm
Seat cushion type (e.g., 60/40, bucket, bench wire, foam, etc.)	Front	Bucket With Polyurethane Padding	
	Rear	Bench With Polyurethane Padding	
	3rd seat	Not Applicable	
Seat back type (e.g., 60/40, bucket, bench, wire, foam, etc.)	Front	Reclining Bucket With Polyurethane Padding	
	Rear	Fixed Bench With Polyurethane Padding*	
	3rd seat	Not Applicable	

\* For Beretta GT & GTZ, 60/40 Split Folding Rear Seat Standard

### Frame

Type and description (separate frame, unitized frame, partially-unitized frame)	Unitized Frame Body-Frame Integral With Bolt-On Powertrain Cradle
---	--

# MVMA Specifications

Vehicle Line BERETTA  
 Model Year 1993 Issued 9-92 Revised \_\_\_\_\_

METRIC (U.S. Customary)

Model Code/Description

BASE

## Restraint System

Seating Position			Left	Center	Right
Active	Type & description (lap & shoulder belt, lap belt, etc.)	First seat	3-Point Manual (Air Bag)		3-Point Manual
		Second seat	3-Point Belt	Adjustable latch 2-Point Belt (Non-Retractor)	3-Point Belt
	Standard/optional	Third seat			
Passive	Type & description (air bag, motorized-2-point belt, fixed belt, knee bolster, manual-lap belt)	First seat	Air Bag		
		Second seat			
	Standard/optional	Third seat			

Glass		SAE Ref No.
Windshield glass exposed surface area sq. cm. (sq. in.)	S1	10303 (1598)
Side glass exposed surface area sq. cm. (sq. in.) - total 2-sides	S2	1794 (278)
Backlight glass exposed surface area sq. cm. (sq. in.)	S3	4813 (746)
Total glass exposed surface area sq. cm. (sq. in.)	S4	16910 (2622)
<input type="radio"/> Windshield glass (type/thickness)		Laminated
<input type="radio"/> Side glass (type/thickness)		Tempered
<input type="radio"/> Backlight glass (type/thickness)		Tempered
<input type="radio"/> Tinted (yes/no, location)		
<input type="radio"/> Solar control (yes/no, coated/batched, location)		

## Headlamps

Description - sealed beam, halogen, replaceable bulb, etc.	Halogen, Replaceable Bulb - 2 Lamps - 2 Bulbs Each
Shape	Rectangular
Lo-beam type (2A1, 2B1, 2C1, etc.)	HB4
Quantity	2
Hi-beam type (1A1, 2A1, 1C1, 2C1, etc.)	HB3
Quantity	2

# MVMA Specifications

Vehicle Line BERETTA  
 Model Year 1983 Issued 9-82 Revised \_\_\_\_\_

## METRIC (U.S. Customary)

Engine Code/Description

BASE

### Climate Control System

Air conditioning (std., opt., man., auto.)		Optional With Manual Operation And Electrically Operated Temperature Door
Condenser	Type	Tube And Fin
	Eff. face area (sq. mm.)	262,080
	Fins per inch	17
Evaporator	Type	3-5-5 Parallel Rib "S" Flow Plate Type, Round Tank
	Eff. face area (sq. mm.)	45,212
	Fins per inch	14
Heater Core	Material	Aluminum
	Eff. face area (sq. mm.)	29,210
	Fins per inch	38
Compressor	Type	V6 (Five Cylinder, Variable Displacement)
	Displacement (cc)	136 (8.3); Optional Engine, 147 (9.2)
	Manufacturer	Harrison Division
	A/C pulley ratio	1.24
Accumulator	Type	None
	Height (mm.)	None
	Diameter (mm.)	None
Receiver	Type	Aluminum R-12 Desiccant
	Height (mm.)	169 (6.7)
	Diameter (mm.)	77 (3.0)
Refrigerant control (CCOT, TVS, etc.)		TXV
Heater water valve (yes / no)		No
Refrigerant (R - 12, R - 134a, etc.)		R-12
Charge level (lbs. - oz.)		2.63 lbs.
Cold engine lockout switch (yes / no)		Yes
Wide open throttle cutout switch (yes / no)		Yes

# MVMA Specifications

Vehicle Line BERETTA  
 Model Year 1993 Issued 9-92 Revised(\*) \_\_\_\_\_

## METRIC (U.S. Customary)

Model Code/Description

BASE

### Convenience Equipment (standard, optional, n.a.)

	Clock (digital, analog)	Digital (Integ. W/Stereo Radios)
	Compass / thermometer	Not Available
	Console (floor, overhead)	Optional, (D55) Full Floor
O	Defroster, electric windshield	
	Defroster, electric backlight	Optional (C49)
Electronic	Diagnostic monitor (integrated, individual)	Not Available
	Instrument cluster (list instruments)	Optional (UB3) Oil Pressure, Temp, Volts, Trip Odom & Tack Standard (UH6) Temp
	Keyless entry	
	Tripminder (avg. spd. fuel)	
	Voice alert (list items)	
	Other	
	Fuel door lock (remote, key, electric)	Not Available
Lamps	Auto head on/off delay, dimming	"
	Cornering	"
	Courtesy (map, reading)	Standard, Map Reading Optional (DC4)
	Door lock, ignition	Not Available
	Engine compartment	"
	Fog	Standard On LZ (T96)
	Glove compartment	Not Available
	Trunk	Standard
	Illuminated entry system (list lamps, activation)	
	Other	Ash Tray Lamp Standard
Mirrors	Day / night (auto. man.)	Optional (DC4) (Manual)
	L.H. (remote, pwr., heated)	Standard (D68) Remote
	R.H.(convex, rmt. pwr, htd)	Standard (D68) Remote
	Visor vanity (RH/LH illum.)	Optional
	Navigation system (describe)	Not Available
	Prkg. brake-auto release (warn. light)	Standard (Manual Release) Lower Area Of Speedometer

\*\* - Available In Optional Custom Interior (RPO B18)



# MVMA Specifications

Vehicle Line BERETTA  
 Model Year 1993 Issued 9-92 Revised(\*)

METRIC (U.S. Customary)

Model Code/Description

BASE

## Convenience Equipment (standard, optional, n.a.)

Power equipment	Deck lid(release, pull down)		Optional (A90) Power Release	
	Door locks (manual, auto., describe system)		Optional (AU3) Power	
	Seats	2 - 4 - 6 way, etc.		Not Available
		Reclining(R.H., L.H.)		"
		Memory (R.H., L.H., preset, recline)		"
		Support (lumbar, hip, thigh, etc.)		"
		Heated (R.H., L.H., other)		"
	Side windows		Optional (A31)	
	Vent windows		Not Available	
	Rear windows		"	
Radio systems	Antenna (location, whip, w/shield, power)		Front Fender - R.H., Fixed Mast Standard	
	Stan.		(UM7) Electronically Tuned AM/FM Stereo Radio With Seek And Scan And Clock. Included Dual Front And Extended Range Rear Speakers.	
	Opt.	AM, FM, stereo, tape, compact disc, graphic equalizer, theft deterrent, radio prep package, headphone jacks, etc.	(UM6) AM/FM Stereo Cassette, Seek And Scan And Clock.	
			(U1C) AM/FM Stereo, Seek/Scan, Clock, ETR & Compact Disc.	
	Speaker (number, location)		(U79) 4 Speakers; 2 In Front And Two In Rear	
Roof: open air or fixed (flip-up, sliding, 'T')			(AD3) Optional Hinged Removable	
Speed control device			(K34) Optional	
Speed warn. dev. (light, buzzer, etc.)			Not Available	
Tachometer (rpm)			(UB3) Optional	
Telephone system (describe)			Not Available	
Theft deterrent system				

## Trailer Towing

Towing capable	Yes / No	Yes
Engine/transmission/axle	Std / Opt	LGO Opt.
Tow class (I, II, III)*	Std / Opt	
Max. gross trailer wgt. (lbs.)	Std / Opt	1000 lbs.
Max. trailer tongue load (lbs.)	Std / Opt	100 lbs.
Towing package available	Yes / No	No

\* Class I - 2,000 lbs. Class II - 3,500 lbs. Class III - 5,000 lbs.

# MVMA Specifications

Vehicle Line BERETTA  
 Model Year 1993 Issued 9-92 Revised \_\_\_\_\_

## METRIC (U.S. Customary)

### Vehicle Dimensions See Key Sheets for definitions

All dimensions to ground are for comparative purposes only. Dimensions are to be shown for all base body models of each vehicle line. SAE Ref. no. refers to the definition published in SAE Recommended Practice J1100 'Motor Vehicle Dimensions,' unless otherwise specified.

#### Model Code/Description

BASE

Width	SAE Ref. No.	
Tread (front)	W101	1417 (55.8)
Tread (rear)	W102	1438 (56.6)
Vehicle width	W103	1724 (67.9)
Body width at Sg RP (front)	W117	1724 (67.9)
Vehicle width (front doors open)	W120	3901 (153.6)
Vehicle width (rear doors open)	W121	Not Applicable
Tumble-home (deg.)	W122	27
Outside mirror width	W410	1957 (77.0)

#### Length

Wheelbase	L101	2627 (103.4)	
Vehicle length	L103	4757 (187.3)	4751 (187) LW & LZ
Overhang (front)	L104	1067 (42.0)	
Overhang (rear)	L105	1063 (41.9)	1057 (41.6) LW & LZ
Upper structure length	L123	2693 (106.0)	
Rear wheel C/L 'X' coordinate	L127	4410 (173.6)	

#### Height \*\*

Passenger distribution (front/rear)	PD1,2,3		**
Trunk/cargo load			**
Vehicle height	H101	1346 (53.0)	
Cowl point to ground	H114	925 (36.4)	
Deck point to ground	H138	998 (39.3)	
Rocker panel-front to ground	H112	217 (8.5)	209 (8.2) LW & LZ
Rocker panel-rear to ground	H111	222 (8.7)	214 (8.4) LW & LZ
Windshield slope angle (deg.)	H122	60.5	
Backlight slope angle (deg.)	H121	65	

#### Ground Clearance \*\*

Front bumper to ground	H102	259 (10.2)	
Rear bumper to ground	H104	264 (10.4)	
Bumper to ground front at curb mass (wt.)	H103	276 (10.9)	
Bumper to ground rear at curb mass (wt.)	H105	292 (11.5)	
Angle of approach (deg.)	H106	13	
Angle of departure (deg.)	H107	19	
Ramp breakover angle (deg.)	H147	15	
Axle differential to ground (front/rear)	H153	Not Available	
Min. running ground clearance	H156	143 (5.6)	
Location of min. run. grd. clear.		Front Suspension	

\*\* All Vehicle Height And Ground Clearance Are Made Using EPA Loaded Vehicle Weight, Loading Conditions.

EPA Loaded Vehicle Weight is the Base Vehicle Weight Plus All Coolant and Fluids Necessary For Operation Plus 100% Of The Fuel Capacity, Plus The Weight Of All Options And Accessories Which Weigh Three Pounds Or More And Which Are Sold On At Least 33% Of The Car Line, Plus Two Occupants.

# MVMA Specifications

Vehicle Line BERETTA  
 Model Year 1993 Issued 9-92 Revised \_\_\_\_\_

## METRIC (U.S. Customary) Vehicle Dimensions

See Key Sheets for Definitions

Model Code/Description

BASE

### Front Compartment

#### SAE Ref. No.

SgRP front, 'X' coordinate	L31	3138 (123.5)
Effective head room	H81	856 (37.6)
Max. eff. leg room (accelerator)	L34	1102 (43.4)
SgRP to heel point	H30	241 (9.5)
SgRP to heel point	L53	908 (35.7)
Back angle (deg.)	L40	26.5
Hip angle (deg.)	L42	103
Knee angle (deg.)	L44	136.5
Foot angle (deg.)	L46	88.5
Design H-point front travel	L17	212 (8.3)
Normal driving & riding seat track trvl.	L23	189 (7.4)
Shoulder room	W3	1392 (54.8)
Hip room	W5	1299 (51.1)
*** Upper body opening to ground	H50	1222 (48.1)
Steering wheel maximum diameter*	W9	386 (15.2)
Steering wheel angle (deg.)	H18	19
Accel. heel pt. to steer. whl. cntr	L11	--
Accel. heel pt. to steer. whl. cntr	H17	--
Undepressed floor covering thickness	H87	12 (0.5)

Front Compartment Int. Dim. Are Measured With The Seating Ref. Pt.  
 (SgRP) mm Forward And mm Upward of Rearmost Position.

### Rear Compartment

SgRP point couple distance	L50	760 (29.9)
Effective head room	H63	930 (36.6)
Min. effective leg room	L51	827 (32.6)
SgRP (second to heel)	H31	262 (10.3)
Knee clearance	L48	-39 (-1.5)
Shoulder room	W4	1402 (55.2)
Hip room	W6	1290 (50.8)
*** Upper body opening to ground	H51	--
Back angle (deg.)	L41	24.5
Hip angle (deg.)	L43	81
Knee angle (deg.)	L45	87
Foot angle (deg.)	L47	119
Depressed floor covering thickness	H73	12 (0.5)

### Luggage Compartment

Usable luggage capacity [L (cu. ft.)]	V1	382.6 (13.5)
*** Lifter height	H195	831 (32.7) 821 (32.3) LW & LZ

### Interior Volumes (EPA Classification)

Vehicle class		Compact
Interior volume index (cu. ft.)**		103.4
Trunk / cargo index (cu. ft.)		13.5

\* See page 14.

\*\* Includes passenger and trunk / cargo index - see definition page 32.

\*\*\* EPA Loaded Vehicle Weight, Loading Conditions.

All Linear Dimensions Are In Millimeters (Inches).

# MVMA Specifications

Vehicle Line BERETTA  
 Model Year 1993 Issued 9-92 Revised(\*)

## METRIC (U.S. Customary) Vehicle Dimensions

See Key Sheets for Definitions

### Model Code/Description

2-DOOR NOTCHBACK COUPES

### Station Wagon / MPV\*\*

#### - Third Seat

SAE Ref. No. (NOT APPLICABLE)

	SAE Ref. No.	(NOT APPLICABLE)
Seat facing direction	SD1	
SgRP couple distance	L85	
Shoulder room	W85	
Hip Room	W88	
Effective leg room	L88	
Effective head room	H88	
SgRP to heel point	H87	
Knee clearance	L87	
Back angle (deg.)	L88	
Hip angle (deg.)	L89	
Knee angle (deg.)	L90	
Foot angle (deg.)	L91	

### Station Wagon / MPV\*\* Cargo Space

(NOT APPLICABLE)

	SAE Ref. No.	(NOT APPLICABLE)
Cargo length (open front)	L200	
Cargo length (open second)	L201	
Cargo length (closed front)	L202	
Cargo length (closed second)	L203	
Cargo length at belt (front)	L204	
Cargo length at belt (second)	L205	
Cargo width (wheelhouse)	W201	
Rear opening width at floor	W203	
Opening width at belt	W204	
Min. rear opening width above belt	W205	
Cargo height	H201	
Rear opening height	H202	
* Tailgate to ground height	H250	
Front seat back to load floor height	H197	
Cargo volume index cu. m. (cu.ft.)	V2	
Hidden cargo vol. index cu. m.(cu.ft.)	V4	
Cargo volume index--rear of 2-seat	V10	
Cargo volume index**	V8	
Cargo width at floor**	W500	
Maximum cargo height**	H505	

### Hatchback - Cargo Space

(NOT APPLICABLE)

	SAE Ref. No.	(NOT APPLICABLE)
Cargo length at front seatback height	L208	
Cargo length at floor (front)	L209	
Cargo length at second seatback height	L210	
Cargo length at floor (second)	L211	
Front seatback to load floor height	H197	
Second seatback to load floor height	H198	
Cargo volume index cu. m. (cu. ft.)	V3	
Hidden cargo vol. index cu. m.(cu.ft.)	V4	
Cargo volume index--rear of 2-seat	V11	

\* EPA Loaded Vehicle Weight, Loading Conditions

\*\* MPV - Multipurpose Vehicle

All Linear Dimensions Are In Millimeters (Inches)

# MVMA Specifications

Vehicle Line BERETTA  
 Model Year 1993 Issued 9-92 Revised(\*) \_\_\_\_\_

METRIC (U.S. Customary)

Model Code/  
Description

2-DOOR NOTCHBACK COUPES

## Vehicle Fiducial Marks

Fiducial Mark Number*	Define Coordinate Location	
Front	X	Fiducial Mark To Vertical Zero Grid Line - Front Measured Horizontally, From The Zero Grid Line To The Front Fiducial Mark Located On Top Of The Front Seat Adjuster Mounting Bolt.
	Y	Fiducial Mark To Centerline Of Car - Front, Width Measurement Made From Centerline Car To Fiducial Mark Located On Top Of The Front Seat Adjuster Mounting Bolt.
	Z	Fiducial Mark To Horizontal Zero Grid Line - Front, Measured Vertically From The Zero Grid Line Front Fiducial Mark Located On Top Of The Front Seat Adjuster Mounting Bolt.
Rear	X	Fiducial Mark To Vertical Zero Grid Line - Rear, Measured Horizontally From The Zero Grid Line To Rear Fiducial Mark Located On The Rail (Compartment Pan - Longitudinal).
	Y	Fiducial Mark To Centerline Of Car - Rear, Width Measurement Made From Centerline Of Car To Fiducial Mark Located On The Rail (Compartment Pan - Longitudinal).
	Z	Fiducial Mark To Horizontal Zero Grid Line - Rear, Measured Vertically From The Zero Grid Line To Rear Fiducial Mark Located On The Rail (Compartment Pan - Longitudinal).
NOTE: Provide 3 of 4 Fiducial Mark Locations		
Front	W21**	346 (13.6)
	L54**	2761 (108.7)
	H81**	211 (8.3)
	*** H181**	238 (9.4)
	*** H163**	260 (10.2)
Rear	W22**	440 (17.3)
	L55**	4953 (195.0)
	H82**	362 (14.3)
	*** H182**	398 (15.7)
	*** H164**	426 (16.8)

- \* Reference - SAE Recommended Practice, J182, Motor Vehicle Fiducial Marks.
  - \*\* Reference - SAE Recommended Practice J1100 - Motor Vehicle Dimensions.
  - \*\*\* EPA Loaded Vehicle Weight, Loading Conditions
- All Linear Dimensions Are In Millimeters (Inches)

# MVMA Specifications

METRIC (U.S. Customary)

Vehicle Line BERETTA  
 Model Year 1993 Issued 9-92 Revised(\*)           

Code	Model	VEHICLE MASS (weight)				% PASS MASS DISTRIBUTION				
		CURB MASS, kg. (lb.)*			SHIPPING MASS kg (lb) ***	ETWC** Code	PASS IN FRONT		PASS IN REAR	
		Front	Rear	Total			Front	Rear	Front	Rear
BERETTA 1LV37 2-Door Notchback Coupe (LN2 & MR3)		738 (1627)	469 (1034)	1207 (2681)		Q				
BERETTA 'GT' 1LW37 2-Door Notchback Coupe (LHO & MG2)		799 (1761)	481 (1060)	1280 (2821)		R				
BERETTA 'GTZ' 1LZ37 2-Door Notchback Coupe (LGO & MV5)		798 (1761)	477 (1052)	1275 (2813)		R				

\* Reference - SAE J1100 Motor vehicle dimensions, curb weight definition.  
 \*\* ETWC - Equivalent Test Weight Class - basis for U.S. Environmental Protection Agency emission certifications.  
 Refer to ETWC code legend below for test weight class.

**ETWC LEGEND**

A = 1000	I = 2000	Q = 3000	4000	Y = 4000
B = 1125	J = 2125	R = 3125	4250	Z = 4250
C = 1250	K = 2250	S = 3250	4500	AA = 4500
D = 1375	L = 2375	T = 3375	4750	BB = 4750
E = 1500	M = 2500	U = 3500	5000	CC = 5000
F = 1625	N = 2625	V = 3625	5250	DD = 5250
G = 1750	O = 2750	W = 3750	5500	EE = 5500
H = 1875	P = 2875	X = 3875	5750	FF = 5750

\*\*\* Shipping Mass (weight) = Curb Weight Less:  
38 (84)

# MVMA Specifications

METRIC (U.S. Customary)

Vehicle Line BERETTA  
 Model Year 1993 Issued 9-92 Revised(\*) \_\_\_\_\_

		Optional Equipment Differential Mass (weight)*			
Code	Equipment	MASS, kg. (lb.)			Remarks Restrictions, Requirements
		Front	Rear	Total	
AU3	Power Door Lock System	.8 (1.3)	1.2 (2.6)	1.8 (3.9)	
A31	Power Windows	1.4 (3.1)	2.2 (4.8)	3.8 (7.9)	
A90	Power Trunk Opener	-2 (-0.4)	1.0 (2.2)	.8 (1.8)	
B19	Custom Interior	1.0 (2.2)	1.0 (2.2)	2.0 (4.4)	Standard On 'GT' Model (Z21)
B34	Floor Mats - Front	1.0 (2.2)	.2 (0.4)	1.2 (2.6)	
B35	Floor Mats - Rear	.2 (0.4)	.6 (1.3)	.8 (1.7)	
CD4	Intermittent Windshield Wiper System	.2 (0.4)	0 (0)	.2 (0.4)	
C49	Electric Rear Window Defogger	0 (0)	.4 (0.9)	.4 (0.9)	
C60	Air Conditioning	21.6 (47.6)	-1.4 (-3.1)	20.2 (44.5)	With RPO LN2 / LGO ENGINES
		21.2 (46.7)	-1.4 (-3.1)	19.8 (43.6)	With RPO LH0 Engine
K05	Engine Block Heater	.2 (0.4)	0 (0)	.2 (0.4)	
K34	Electronic Speed Control	1.8 (3.9)	0 (0)	1.8 (3.9)	

\* Also see Engine - General Section for dressed engine mass (weight).

# MVMA Specifications

METRIC (U.S. Customary)

Vehicle Line BERETTA  
 Model Year 1993 Issued 9-92 Revised(\*)           

		Optional Equipment Differential Mass (weight)*			
Code	Equipment	MASS, kg. (lb.)			Remarks Restrictions, Requirements
		Front	Rear	Total	
LH0	3.1 Liter V6 Engine	45 (99)	-3.0 (-6.6)	42 (93)	
MD9	Automatic Transmission	18.2 (40.1)	-1.6 (-3.5)	16.6 (36.6)	With RPO LN2 Engine
		16.6 (36.6)	-1.4 (-3.1)	15.2 (33.5)	With RPO LH0 Engine
N33	Comfortilt Steering Wheel	.4 (0.9)	.2 (0.4)	.6 (1.3)	
PF2	Styled Aluminum Wheels - 15"	-3.2 (-7.0)	-3.2 (-7.0)	-6.4 (-14.0)	
UA1	Heavy Duty Battery	3.0 (6.6)	-0.4 (-0.9)	2.6 (5.7)	Required With Auto. Trans. On L4. Mandatory For Canada
UM6	AM/FM Stereo Radio, Cassette Player With Clock			0	
VK3	Front License Plate Mounting	0.4 (0.9)	0 (0)	0.4 (0.9)	
V56	Deck Lid Luggage Rack (Charcoal)	.6 (1.3)	2.6 (5.7)	3.2 (7.0)	
Z21	'Beretta GT' Option	53.8 (118.6)	9.0 (19.8)	62.8 (138.4)	

\* Also see Engine - General Section for dressed engine mass (weight).



**MVMA Specifications**  
**METRIC (U.S. Customary)**

**Exterior Vehicle And Body Dimensions – Key Sheet**

**Exterior Width**

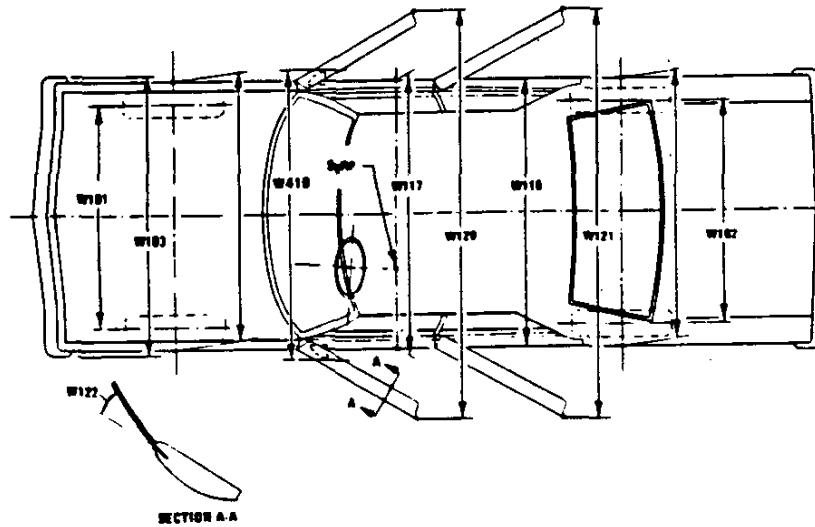

**Exterior Length & Height**

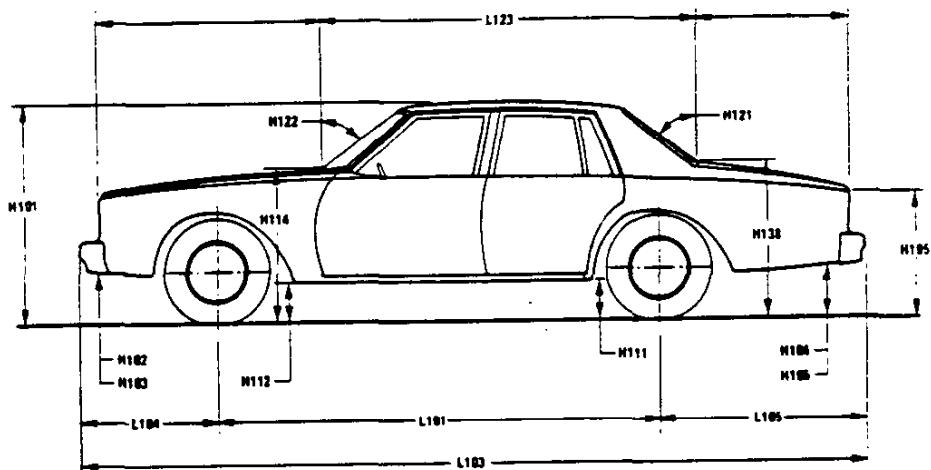

**Exterior Ground Clearance**

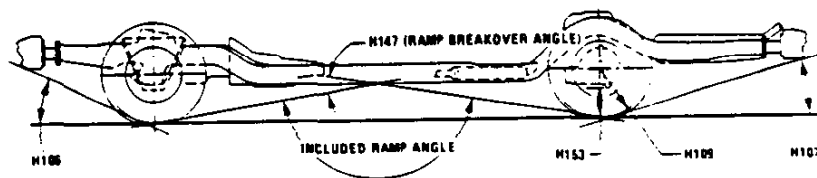

# MVMA Specifications Form

## METRIC (U.S. Customary)

### Interior Vehicle And Body Dimensions – Key Sheet

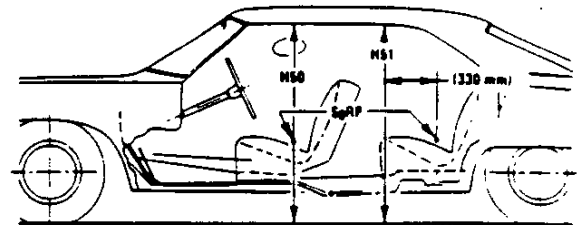
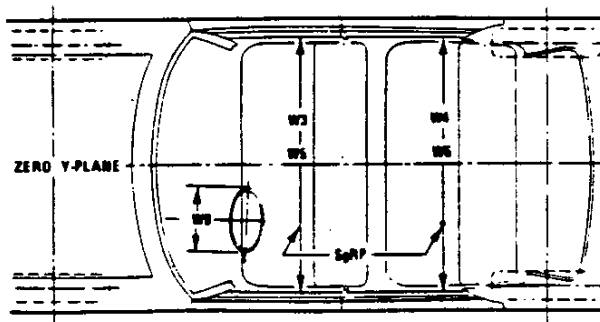
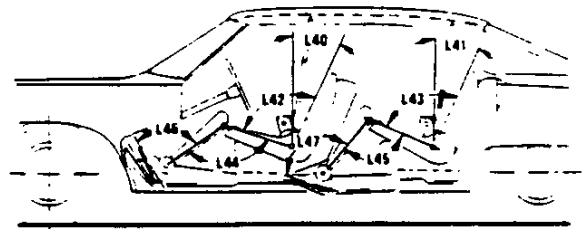
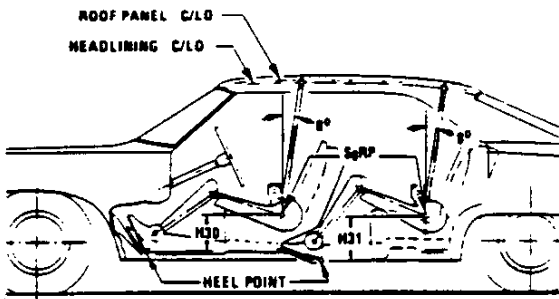
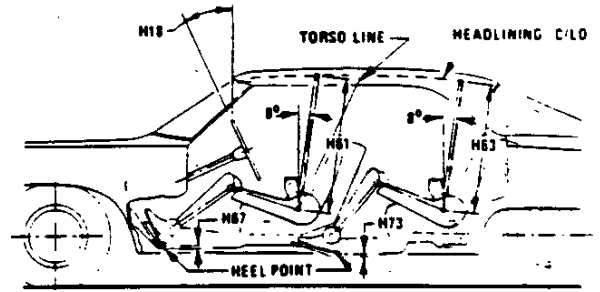
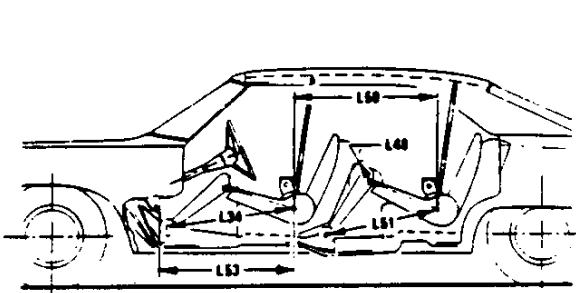

# MVMA Specifications

METRIC (U.S. Customary)

## Interior Vehicle And Body Dimensions – Key Sheet

### Third Seat

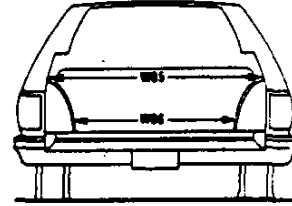
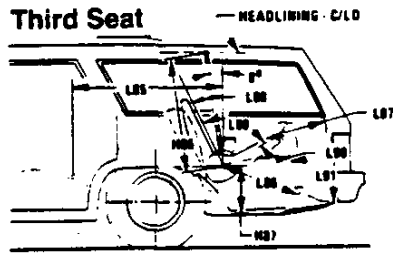

### Cargo Space

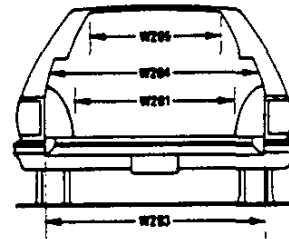
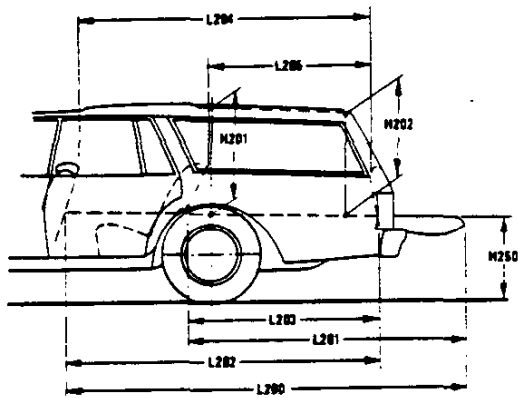

### Station Wagon

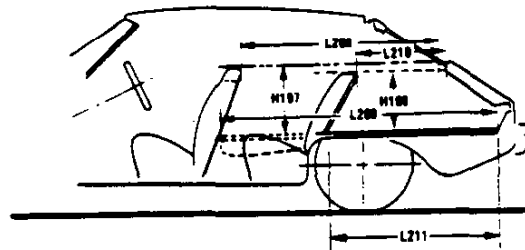

### Hatchback

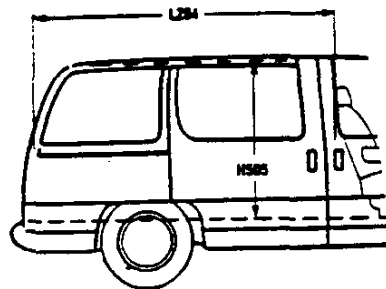

### Multipurpose Vehicle

# MVMA Specifications

## METRIC (U.S. Customary)

### Exterior Vehicle And Body Dimensions – Key Sheet Dimensions Definitions

#### Seating Reference Point

SEATING REFERENCE POINT means the manufacturer's design reference point which –  
(a) Establishes the rearmost normal design driving or riding position of each designated seating position in a vehicle;  
(b) Has coordinates established relative to the design vehicle structure;  
(c) Simulates the position of the pivot center of the human torso and thigh; and  
(d) Is the reference point employed to position the two dimensional templates described in SAE Recommended Practice J826, "Devices for Use in Defining and Measuring Vehicle Seating Accommodations."

#### Width Dimensions

- W101 TREAD – FRONT. The dimension measured between the tire centerlines at the ground.
- W102 TREAD – REAR. The dimension measured between the tire centerlines at the ground. In case of dual wheels, the dimension will be measured to the centerline of tire and wheel assemblies.
- W103 VEHICLE WIDTH. The maximum dimension measured between the widest point on the vehicle, excluding exterior mirrors, flexible mud flaps, marker lamps, but including bumpers, moldings, sheet metal protrusions or dual wheels, if standard equipment.
- W117 BODY WIDTH AT SgRP – FRONT. The dimension measured laterally between the widest points on the body at the SgRP-front, excluding door handles, applied moldings, or appliques.
- W120 VEHICLE WIDTH – FRONT DOORS OPEN. The dimension measured between the widest point on the front doors in maximum hold-open position.
- W121 VEHICLE WIDTH – REAR DOORS OPEN. The dimension measured between the widest point on the rear doors in maximum hold-open position. For vehicles with a rear door on only one side, this dimension is to the zero "Y" plane.
- W122 TUMBLE – HOME. STRAIGHT SIDE GLASS. The angle measured from a vertical to the outside surface of the front door glass at the SgRP "X" plane.  
CURVED SIDE GLASS. The angle measured from a vertical to a chord extending from the upper DLO to the lower DLO at the outside surface of the front door glass at the front SgRP "X" plane.
- W410 OUTSIDE MIRROR WIDTH. The dimension between the widest point on the outside mirrors. The standard right and left mirror adjusted for normal driving will be shown unless otherwise noted. When only one outside mirror is standard, the dimension will be to the zero "Y" plane.

#### Length Dimensions

- L101 WHEELBASE (WB). The dimension measured longitudinally between front and rear wheel centerlines. In case of dual rear axles, the dimension shall be to the midpoint of the centerlines of the rear wheels.
- L103 VEHICLE LENGTH. The maximum dimension measured longitudinally between the foremost point and the rearmost point on the vehicle, including bumper, bumper guards, tow hooks and/or rub strips, if standard equipment.
- L104 OVERHAND – FRONT. The dimension measured longitudinally from the centerline of the front wheels to the foremost point on the vehicle including bumper, bumper guards, tow hooks and/or rub strips, if standard equipment.
- L105 OVERHANG – REAR. The dimension measured longitudinally from the centerline of the rear wheels; or in the case of dual rear axles, the dimension shall be the midpoint of the centerlines of the rear wheels, to the rearmost point on the vehicle including rear bumpers, bumper guards, tow hooks and rub strips, if standard equipment.

- L123 UPPER STRUCTURE LENGTH. The dimension measured longitudinally from the cowl point to the deck point.
- L127 REAR WHEEL CENTERLINE "X" COORDINATE or in the case of dual rear axles, the coordinate shall be the midpoint of the distance between the rear axle centerlines.

#### Height Dimensions

- H101 VEHICLE HEIGHT. The dimension measured vertically from the highest point on the vehicle body to ground.
- H111 ROCKER PANEL – REAR TO GROUND. The dimension measured vertically from the bottom of the rocker or side quarter panel at the front of the rear wheel opening, excluding flanges, to ground.
- H112 ROCKER PANEL – FRONT TO GROUND. The dimension measured vertically from the foremost point on the bottom of the rocker panels, excluding flanges, to ground.
- H114 COWL POINT TO GROUND. Measured at zero "Y" plane.
- H121 BACKLIGHT SLOPE ANGLE. The angle between the vertical reference line and the surface of backlight at vehicle zero "Y" plane. For curve backlight, the angle is to chord of backlight arc from lower DLO to upper DLO.
- H122 WINDSHIELD SLOPE ANGLE. The angle between the vertical reference line and a chord of the windshield arc running from the lower DLO to the upper DLO at the vehicle zero "Y" plane. In the case of wrap over glass, the angle to be measured will be formed by a chord 457 mm (18.0 in.) long drawn from the lower DLO to the intersecting point on the windshield.
- H138 DECK POINT TO GROUND. Measured at zero "Y" plane.
- H109 STATICLOAD – TIRE RADIUS – REAR. Specified by the manufacturer in accordance with composite TIRE SECTION STANDARD.

#### Ground Clearance Dimensions

- H102 FRONT BUMPER TO GROUND. The minimum dimension measured vertically from the lowest point on the front bumper to ground, including bumper guards, if standard equipment.
- H103 FRONT BUMPER TO GROUND – CURB MASS (WT.). Measured in the same manner as H102.
- H104 REAR BUMPER TO GROUND. The minimum dimension measured vertically from the lowest point on the rear bumper to ground, including bumper guards, if standard equipment.
- H105 REAR BUMPER TO GROUND – CURB MASS (WT.). Measured in the same manner as H104.
- H106 ANGLE OF APPROACH. The angle measured between a line tangent to the front tire static loaded radius arc and the initial point of structural interference forward of the front tire to ground. The limiting structural component shall be designated.
- H107 ANGLE OF DEPARTURE. The angle measured between a line tangent to the rear tire static loaded radius arc and the initial point of structural interference rearward of the rear tire to ground. The limiting component shall be designated.
- H147 RAMP BREAKOVER ANGLE. The angle measured between two lines tangent to the front and rear tire static loaded radius and intersecting at a point on the underside of the vehicle which defines the largest ramp over which the vehicle can roll.
- H153 REAR AXLE DIFFERENTIAL TO GROUND. The minimum dimension measured from the rear axle differential to ground.
- H156 MINIMUM RUNNING GROUND CLEARANCE. The minimum dimension measured from the sprung vehicle to ground. Specify location.

# MVMA S METRIC (L)

## Interior Vehicle Dimensions

### Glass Areas

- S1 Windshield
- S2 Side window and rear window
- S3 Backlight
- S4 Total area

### Fiducial Mark D:

- L54 "X" coord
- W21 "Y" coord
- H81 "Z" coord
- H161 Height "Z"
- H163 Height "Z"
- L55 "X" coord
- W22 "Y" coord
- W82 "Z" coord
- H162 Height "Z"
- H164 Height "Z"

### Front Compartm

- L11 ACCELERATOR CENTER POINT TO AHP TO TORO and a plane wheel rim
- L17 DESIGNATED HORIZONTAL FOREMOST J1100
- L23 NORMAL The dimension the design point on the travel use positions
- L31 SgRP - FRONT
- L34 MAXIMUM dimension to the SgRP foot on the with SgRP pedal mark If the accelerator foot flat on
- L40 BACK ANGLE vertically on seatback position
- L42 HIP ANGLE line and centerline leg
- L44 KNEE ANGLE centerline leg
- L46 FOOT ANGLE lower leg of the bare SAE J826
- L53 SgRP - FRONT tally from
- W3 SHOULDER OPENING measured laterally plane through and 254 mm door assist

et

parts

HEEL  
to the  
engine  
bearing

meas-  
ure the  
SAE

HEEL  
on  
accel-  
erated  
track  
loading

The  
center  
right  
pedal  
toro-  
place

when a  
line  
loading

torso  
right

to the  
heel  
Ref

con-  
meas-  
ure  
the  
of the

- W5 HIP ROOM - FRONT. The minimum dimension measured laterally between the trimmed surfaces on the "X" plane through the SgRP - front within 25 mm (1.0 in.) below and 76 mm (3.0 in.) above the SgRP - front and 76 mm (3.0 in.) fore and aft of the SgRP - front.
- W9 STEERING WHEEL MAXIMUM OUTSIDE DIAMETER. Define if other than round.
- H7 ACCELERATOR HEEL POINT TO THE STEERING WHEEL CENTER. The dimension measured vertically from the AHP - front to the intersection of the steering column centerline to a plane tangent to the upper surface of the steering wheel rim.
- H18 STEERING WHEEL ANGLE. The angle measured from a vertical to the surface plane of the steering wheel.
- H30 SgRP - FRONT TO HEEL. The dimension measured vertically from the SgRP - front to the accelerator heel point.
- H50 UPPER BODY OPENING TO GROUND - FRONT. The dimension measured vertically from the trimmed body opening to the ground on the SgRP - front "X" plane.
- H61 EFFECTIVE HEAD ROOM - FRONT. The dimension measured along a line 8 deg. rear of vertical from the SgRP - front to the headlining plus 102 mm (4.0 in.).
- H67 FLOOR COVERING THICKNESS - UNDEPRESSED - FRONT. The dimension measured vertically from the surface of the depressed floor covering to the underbody sheet metal at the accelerator heel point.

### Rear Compartment Dimensions

- L41 BACK ANGLE - SECOND. The angle measured between a vertical line through the SgRP - second and the torso line
- L43 HIP ANGLE - SECOND. The angle measured between torso line and thigh centerline.
- L45 KNEE ANGLE - SECOND. The angle measured between thigh centerline and lower leg centerline.
- L47 FOOT ANGLE - SECOND. The angle measured between the lower leg centerline and a line tangent to the ball and heel of the three-dimensional devices bare foot flesh line (Reference J826).
- L48 KNEE CLEARANCE - SECOND. The minimum dimension measured from the knee pivot center to the back of the front seatback minus 51 mm (2.0 in.).
- L50 SgRP COUPLE DISTANCE - SECOND. The dimension measured horizontally from the driver SgRP - front to the SgRP - second.
- L51 MINIMUM EFFECTIVE LEG ROOM - SECOND. The dimension measured along a line from the ankle pivot center to the SgRP - second plus 254 mm (10.0 in.).
- W4 SHOULDER ROOM - SECOND. The minimum dimension measured laterally between door or quarter trimmed surfaces on the "X" plane through the SgRP - second at height between 254-406 mm (10.0-16.0 in.) above the SgRP - second, excluding the door assist straps and attaching parts.
- W6 HIP ROOM - SECOND. Measured in the same manner as W5.
- H31 SgRP - SECOND TO HEEL. The dimension measured vertically from the SgRP - second to the two dimensional device heel point on the depressed floor covering.
- H51 UPPER BODY OPENING TO GROUND - SECOND. The dimension measured vertically from the trimmed body opening to the ground on the "X" plane 330 mm (13.0 in.) forward of the SgRP - second.
- H63 EFFECTIVE HEAD ROOM - SECOND. The dimension measured along a line 8 deg. rear of vertical from the SgRP to the headlining, plus 102 mm (4.0 in.).
- H73 FLOOR COVERING - DEPRESSED - SECOND. The dimension measured vertically from the heel point to the underbody sheet metal

# MVMA Specifications

## METRIC (U.S. Customary)

### Interior Vehicle And Body Dimensions – Key Sheet Dimensions Definitions

#### Luggage Compartment Dimensions

V1 USABLE LUGGAGE CAPACITY – Total of volumes of individual pieces of standard luggage set plus H-boxes stowed in the luggage compartment in accordance with the procedure described in paragraph 8.2 of SAE-J1100a.

#### Interior Volumes (EPA Classification)

The Interior Volume Index is listed for each body style except two seaters. The Interior Volume Index estimates the space in a car. It is based on four measurements – head room, shoulder room, hip room, and leg room – for the front and rear seats, plus trunk capacity.

The Trunk/Cargo Index is an estimate of the size of the trunk/cargo space. In station wagons and hatchbacks it is an estimate of the space behind the second seat.

#### Station Wagon / MPV – Third Seat Dimensions

L85 SgRP COUPLE DISTANCE – THIRD. The dimension measured horizontally from the SgRP – second to the SgRP – third.

L86 EFFECTIVE LEG ROOM – THIRD. The dimension measured along a line from the ankle pivot center to the SgRP – third plus 254 mm (10.0 in.).

L87 KNEE CLEARANCE – THIRD. The minimum dimension from the knee pivot center to the back of second seatback minus a constant of 51 mm (2.0 in.). With rear-facing third seat, dimension is measured to closure.

L88 BACK ANGLE – THIRD. Measured in the same manner as L41.

L89 HIP ANGLE – THIRD. Measured in the same manner as L43.

L90 KNEE ANGLE – THIRD. Measured in the same manner as L45.

L91 FOOT ANGLE – THIRD. Measured in the same manner as L47.

W85 SHOULDER ROOM – THIRD. Measured in the same manner as W4.

W86 HIP ROOM – THIRD. Measured in the same manner as W5.

H86 EFFECTIVE HEAD ROOM – THIRD. The dimension, measured along a line 8 deg. from the SgRP – third to the headlining rear of vertical plus a constant of 102 mm (4.0 in.).

H87 SgRP – THIRD TO HEEL POINT

SD1 SEAT FACING DIRECTION – THIRD

#### Station Wagon / MPV – Cargo Space Dimensions

L200 CARGO LENGTH – OPEN – FRONT. The minimum dimension measured longitudinally from the back of the front seatback at the height of the undepressed floor covering to the rearmost point on the undepressed floor covering on the open tailgate or cargo surface if the rear closure is a conventional door type tailgate at the zero "Y" plane.

L201 CARGO LENGTH – OPEN – SECOND. The dimension measured longitudinally from the back of the second seatback at the height of the undepressed floor covering to the rearmost point on the undepressed floor covering on the open tailgate or cargo floor surface if the rear closure is a conventional door type tailgate, at the zero "Y" plane.

L202 CARGO LENGTH – CLOSED – FRONT. The minimum dimension measured horizontally from the back of the front seat at the height of the undepressed floor covering to the rearmost point on the undepressed floor covering on the closed tailgate or taildoor for station wagons, trucks and mpv's at the zero "Y" plane.

L203 CARGO LENGTH – CLOSED – SECOND. The dimension measured horizontally from the back of the second seat at the height of the undepressed floor covering to the rearmost point on the undepressed floor covering on the closed tailgate or taildoor for station wagons, trucks and mpv's at the zero "Y" plane.

L204 CARGO LENGTH AT BELT – FRONT. The minimum dimension measured horizontally from the back of the front seatback at the seatback top to the foremost normal surface of the closed tailgate or inside surface of the cab backpanel at the height of the belt, on the zero "Y" plane.

L205 CARGO LENGTH AT BELT – SECOND. The minimum dimension measured horizontally from the back of the second seatback at the seatback top to the foremost normal surface of the closed tailgate at the height of the belt, on the zero "Y" plane.

W201 CARGO WIDTH – WHEELHOUSE. The minimum dimension measured laterally between the trimmed wheelhouseings at floor level. For any vehicle not trimmed, measure to the sheet metal.

W203 REAR OPENING WIDTH AT FLOOR. The minimum dimension measured laterally between the limiting interferences of the rear opening at floor level.

W204 REAR OPENING WIDTH AT BELT. The minimum dimension measured laterally between the limiting interferences of the rear opening at belt height or top of pick box.

W205 REAR OPENING WIDTH ABOVE BELT. The minimum dimension measured laterally between the limiting interferences of the rear opening above the belt height.

W500 CARGO WIDTH AT FLOOR. The maximum dimension measured laterally between the limiting interferences at the floor level. This dimension shall include ribs and pillars, but will exclude wheelhouses.

H197 FRONT SEATBACK TO LOAD FLOOR HEIGHT. The dimension measured vertically from the horizontal tangent to the top of the seatback to the undepressed floor covering.

H201 CARGO HEIGHT. The dimension measured vertically from the top of the undepressed floor covering to the headlining at the rear wheel "X" coordinate on the zero "Y" plane.

H202 REAR OPENING HEIGHT. The dimension measured vertically from the top of the undepressed floor covering to the upper trimmed opening on the zero "Y" plane with rear door fully open.

H250 TAILGATE TO GROUND CURB MASS (WT.). The dimension measured vertically from the top of the undepressed floor covering on the lowered tailgate to ground on the zero "Y" plane.

H505 MAXIMUM CARGO HEIGHT. The maximum vertical dimension rear of the front seat from the cargo floor to roof bow or headlining at the zero "Y" plane.

# MVMA Specifications

## METRIC (U.S. Customary)

### Interior Vehicle And Body Dimensions – Key Sheet Dimensions Definitions

#### V2 STATION WAGON

Measured in inches:

$$\frac{W4 \times H201 \times L204}{1728} = \text{ft}^3$$

Measured in mm:

$$\frac{W4 \times H201 \times L204}{10^9} = \text{m}^3 \text{ (cubic meter)}$$

#### V4 HIDDEN LUGGAGE CAPACITY – REAR OF FRONT SEAT.

The total volumes of individual pieces of one set of standard luggage stowed in any hidden cargo area below the load floor rear of the front seat.

#### V5 TRUCKS AND MPV'S WITH OPEN AREA.

Measured in inches:

$$\frac{L506 \times W505 \times H503}{1728} = \text{ft}^3$$

Measured in mm:

$$\frac{L506 \times W505 \times H503}{10^9} = \text{m}^3 \text{ (cubic meter)}$$

#### V6 TRUCKS AND MPV'S WITH CLOSED AREA

Measured in inches:

$$\frac{L204 \times W500 \times H505}{1728} = \text{ft}^3$$

Measured in mm:

$$\frac{L204 \times W500 \times H505}{10^9} = \text{m}^3 \text{ (cubic meter)}$$

#### V8 HIDDEN LUGGAGE CAPACITY – REAR OF SECOND SEAT.

The total volume of individual pieces of one set of standard luggage stowed in any hidden cargo area below the load floor rear of the second seat.

#### V10 STATION WAGON CARGO VOLUME INDEX.

Measured in inches:

$$\frac{H201 \times L205 \times \frac{W4 + W201}{2}}{1728} = \text{ft}^3$$

Measured in mm:

$$\frac{H201 \times L205 \times \frac{W4 + W201}{2}}{10^9} = \text{m}^3 \text{ (cubic meter)}$$

#### Hatchback – Cargo Space Dimensions

All hatchback cargo dimensions are to be taken with the front seat in full down and rear position, and the rear seat folded down. The hatchback door is in the closed position. (For electronically adjusted seats, see the manufacturer's specifications for Design "H" Point).

**L208 CARGO LENGTH AT FRONT SEATBACK HEIGHT.** The minimum horizontal dimension from the "X" plane tangent to the rearmost surface of the driver's seatback to the inside limiting interference of the hatchback door on the vehicle zero "Y" plane.

**L209 CARGO LENGTH AT FLOOR – FRONT.** The minimum horizontal dimension measured at floor level from the rear of the front seatback to the normal limiting interference of the hatchback door on the vehicle zero "Y" plane.

**L210 CARGO LENGTH AT SECOND SEATBACK HEIGHT.** The minimum dimension measured from the "X" plane tangent to the rearmost surface of second seatback or the load floor which is stowed at least one half of the H198 dimension height above the rear load floor, to the rearmost inside limiting interference on the zero "X" plane.

**L211 CARGO LENGTH AT FLOOR – SECOND SEATBACK.** The minimum horizontal dimension measured at floor level from the rear of the second seatback or load floor panel to the normal limiting interference of the hatchback door on the vehicle zero "Y" plane.

**H197 FRONT SEATBACK TO LOAD HEIGHT.** The dimension measured vertically from the horizontal tangent to the top of the seatback to the undepressed floor covering.

**H198 SECOND SEATBACK TO LOAD FLOOR HEIGHT.** The dimension measured vertically from the second seatback to the undepressed floor covering.

#### V3 HATCHBACK.

Measured in inches:

$$\frac{L208 - L209}{2} \times W4 \times H197 = \text{ft}^3$$

Measured in mm:

$$\frac{L208 - L209}{2} \times W4 \times H197 = \text{m}^3 \text{ (cubic meter)}$$

**V4 HIDDEN LUGGAGE CAPACITY – REAR OF FRONT SEAT.** The total volumes of individual pieces of one set of standard luggage stowed in any hidden cargo area below the load floor rear of the front seat.

**V11 HATCHBACK CARGO VOLUME INDEX.** Usable luggage (one (1) stand and luggage set) below floor:

Measured in inches:

$$\frac{L210 + L211}{2} \times W4 \times H198 = \text{ft}^3$$

Measured in mm:

$$\frac{L210 + L211}{2} \times W4 \times H198 = \text{m}^3 \text{ (cubic meter)}$$

# MVMA Specifications

METRIC (U.S. Customary)

## Index

Subject	Page No.	Subject	Page No.
Alternator	16	Passenger Capacity	1
Axle Drive, Front, Rear, All Four	2, 9, 10	Passenger Mass Distribution	26
Axle Shafts	10	Pistons	3
Battery	16	Power Brakes	12
Body and Miscellaneous Information	17	Power, Engine	2
Brakes - Parking Service	12, 13	Power Steering	14
Camber	15	Power Teams	2
Camshaft	3	Propeller Shaft	10
Capacities		Pumps - Fuel	6
Cooling System	5	Water	5
Fuel Tank	6	Radiator - Cap, Hoses, Core	5
Lubricants		Ratios - Axle, Transaxle	2, 9, 10
Engine Crankcase	4	Compression	2
Transmission Transaxle	8, 9	Steering	14
Rear Axle	10	Transmission Transaxle	2, 8, 9
Carburetor	2, 6	Rear Axle	2, 10
Caster	15	Regulator - Alternator	16
Climate Control System	19	Restraint System	18
Clutch - Pedal Operated	8	Rims	13
Coil, Ignition	16	Rods - Connecting	4
Connecting Rods	4	Scrub Radius	14
Convenience Equipment	20-21	Seats	17
Cooling System	5	Shock Absorbers, Front & Rear	11
Crankshaft	4	Spark Plugs	16
Cylinders and Cylinder Head	3	Speedometer	15
Diesel Information	4	Springs - Front & Rear Suspension	11
Dimension Definitions		Stabilizer (Sway Bar) - Front & Rear	11
Key Sheet - Exterior	28, 31, 32	Starting System	16
Key Sheet - Interior	29, 30, 32, 33, 34	Steering	14
Electrical System	15, 16	Suppression - Ignition, Radio	16
Emission Controls	7	Suspension - Front & Rear	11
Engine - General		Tail Pipe	7
Bore, Stroke, Type	3	Theft Protection	21
Compression Ratio	2	Thermostat, Cooling	5
Displacement	2, 3	Tires	13
Firing Order, Cylinder Numbering	3	Toe-In	15
General Information, Power & Torque	2	Torque Converter	9
Intake System	4	Torque - Engine	2, 8, 9
Power Teams	2	Trailer Towing	21
Exhaust System	7	Transaxle	9
Equipment Availability, Convenience	20	Transmission - Types	2, 8, 9
Fan, Cooling	5	Transmission - Automatic	2, 9
Filters - Engine Oil, Fuel System	4	Transmission - Manual	2, 8
Four Wheel Drive	10	Transmission - Ratios	2, 8, 9
Frame	17	Tread	22
Front Suspension	11	Trunk Cargo Load	1
Front Wheel Drive Unit	10	Trunk Luggage Capacity	23
Fuel Economy, EPA	1	Turning Diameter	14
Fuel Injection	6	Unrozed Construction	18
Fuel System	6	Universal Joints, Propeller Shaft	10
Fuel Tank	6	Valve System	4
Glass	18	Vehicle Dimensions	
Headlamps	18	Width	22
Headroom - Body	23, 24	Length	22
Heights	22	Height	22
Horns	15	Ground Clearance	22
Horsepower - Brake	2	Front Compartment	23
Ignition System	16	Rear Compartment	23
Inflation - Tires	13	Luggage Compartment	23
Interior Volumes	23	Station Wagon - Third Seat	24
Instruments	15	Station Wagon - Cargo Space	24
Legroom	23, 24	Hatchback - Cargo Space	24
Lengths	22	Fiducial Marks	25
Leveling, Suspension	11	Voltage Regulator	16
Lifters, Valve	4	Water Pump	5
Linings - Clutch, Brake	8, 12	Weights	26, 27
Lubrication - Engine, Transmission, Transaxle	4, 8, 9	Wheel Alignment	15
Luggage Compartment	23	Wheelbase	22
Models	1	Wheels & Tires	13
Motor Starting	16	Wheel Spindle	14
Muffler	7	Widths	22
Origin	1	Windshield	18
		Windshield Wiper and Washer	15