

G34 Chevy Van

ORDERING INFORMATION

Focus Vehicle—G20 Regular-Body Chevy Van with 125" wheelbase. This dependable long-lasting van has broad appeal for commercial use and RV conversion. When equipped with PEG 2 (GVA2), this model represents an excellent opportunity for high-volume Chevy Van sales at your dealership.

Feature Vehicle—G30 Extended-Body Chevy Van with 146" wheelbase (detailed on the following sheet)

Performance

■ **4.3 Liter EFI V6 Engine with Balance Shaft**—enhanced engine smoothness, provides 155 hp/235 lb.-ft. of torque ■ **Four-Speed Electronically Controlled Automatic Transmission with Overdrive**—coordinates engine speed with vehicle load for smooth, consistent shifts whether carrying small payload or towing trailer ■ **Four-Wheel Anti-Lock Brake System**—reduces chance of wheel lockup helping driver maintain control during severe braking, even on slippery surfaces

Options

■ **Engine Choices**—a wide range of engines are available to meet varying commercial needs, including standard 4.3 Liter V6, gasoline 5.0 Liter, 5.7 Liter, 7.4 Liter V8s, and two naturally aspirated 6.5 Liter diesel V8s ■ **Auxiliary Climate Control Systems**—provide high levels of comfort for all climates. Available options include front air conditioning, front and rear air conditioning and auxiliary rear heater ■ **Body Glass**—Chevy Van offers a number of different glass configurations, including a full body, six window package. All glass packages feature Solar-Ray Tinted Glass

Work Credentials

■ **Trailer Towing**—G20 can tow up to 7,000 lbs. when properly equipped (a properly equipped G30 can tow up to 10,000 lbs.) ■ **Sliding Side Cargo Door**—permits parking close to loading area, ready cargo access ■ **High Carrying Capacity**—payload up to 2,697 lbs. for properly equipped G20 (4,288 lbs. for G30 with optional heavy-duty chassis equipment package) ■ **Cargo Capacity**—up to 260 cu. ft. of cargo room with 125" wheelbase (up to 306 cu. ft. with extended-body)

Easy

—**TO OWN** ■ **Standard Analog Instrumentation**—monitors vital engine functions, including engine temperature, odometer, oil pressure, speedometer, trip odometer, voltmeter ■ **Solar-Ray Tinted Glass**—screens out much of the sun's ultraviolet and infrared rays to help keep interior cool, helps reduce fading and deterioration of interior fabrics/trim

—**ON THE MIND** ■ **Standard Driver-Side Facial Air Bag**—in conjunction with seat belts, helps protect against facial and head injuries in certain frontal collisions (not available on Chevy Vans above 8,600 lbs. GVWR) ■ **Center High-Mounted Stop Lamp**—highly visible signal helps prevent rear end collisions ■ **Roadside Assistance**—24-hour service assistance via Chevrolet's toll-free "800" number. Fast response for towing, repairs, and other services

Reliability/Durability

■ **Two-Sided Galvanized Steel**—outer body panels (except roof) resist corrosion ■ **Serpentine Accessory Drive Belt**—automatic tension adjustment, designed to provide longer service life than conventional belt systems ■ **Bumper-to-Bumper Plus Warranty**—3-year/36,000-mile, no-deductible limited warranty includes parts, labor, 6-year/100,000-mile body sheet metal rust-through protection, 5-year/50,000-mile emissions control system coverage. (Tires covered by their manufacturer.) ■ **Chevrolet Diesel Engine Warranty**—5-year/100,000-mile warranty, \$100 deductible after 3 years/36,000 miles

RED ■ : New Feature
BLACK ■ : Focus Vehicle Feature

FEATURE VEHICLE: G30 EXTENDED-BODY CHEVY VAN

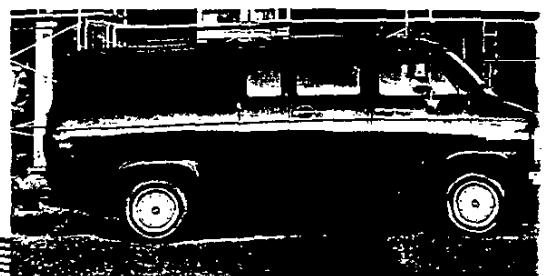

FOCUS
VEHICLE:
G20
REGULAR-
BODY
CHEVY VAN

G34 Chevy Van

Trim Color/Seat Style Availability

Custom vinyl
available in Black, Blue,
Garnet, Beige and Gray

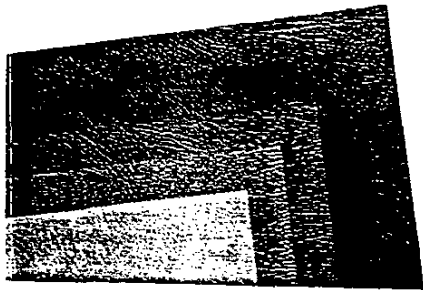

High-Back Bucket Seats
driver seat is standard
passenger seat is optional

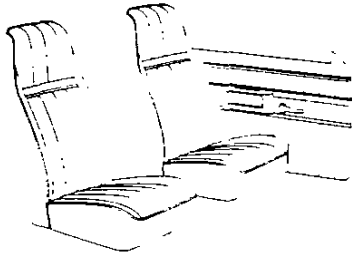

Four Most Popular Exterior Colors By Percentage

Below are the anticipated four most popular Chevy Van colors for 1994 based on national sales volume. They are listed for reference only. To identify the top selling colors in your area, by model, use the Retail Sales Analysis (RSA).

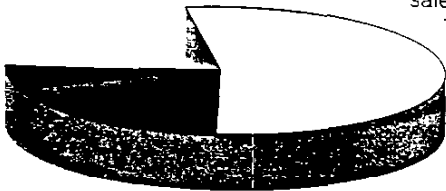

Summit White	54%
Emerald Green Metallic	10%
Brilliant Blue Metallic	8%
Midnight Black	6%

Four Most Popular Exterior Colors with Corresponding Interior Color Availability

		I N T E R I O R				
		Black	Blue	Garnet	Beige	Gray
EXTERIOR	Summit White	■	■	■	■	■
	Emerald Green Metallic				■	■
	Brilliant Blue Metallic		■			■
	Midnight Black	■	■	■	■	■

NOTE: New Chevy Van exterior colors are Gunmetal, Brilliant Blue Metallic, Indigo Blue Metallic, Emerald Green Metallic, Sand Beige Metallic and Victory Red.

Wheels



Standard 15" x 6"
steel - painted Argent - G10 & G20



Standard 16" x 6.5"
steel - painted Argent - G30

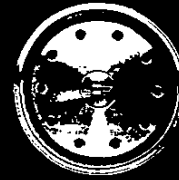

Optional
Bright metal full wheel cover - G30

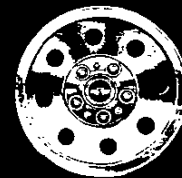

Optional cast-aluminum wheel
(not available on G30 series)



Optional Rally Wheel
(not available on G30 series)

'94 Chevy Van

Forecasted Percent of Mix

Series

G10	5%
G20	85%
G30	10%
Total	100%

Trim Levels

Standard	100%
Total	100%

Engines

4.3L V6 EFI	6%
5.0L V8 EFI	6%
5.7L V8 EFI	35%
6.5L V8 Diesel	1%
6.5L V8 Diesel HD	1%
7.4L V8 EFI	1%
Total	100%

Transmissions

4-Speed Electronically Controlled Automatic with Overdrive	100%
Total	100%

Deletions

- **P215 Tires** become base on the G10 model which is now rated at 6,000 lbs. GVW. Both 4,900 and 5,600 lb. GVWs have been eliminated.
- **The 6.5 Liter Naturally Aspirated V8 Diesel Engine in both Light Duty and Heavy Duty versions** replaces the 6.2 Liter V8 Diesels offered in 1993. They offer improvements in power, reliability and durability.
- **Chrome-Plated Outside Rearview Mirrors** are standard equipment replacing last year's white painted mirrors.
- **Eight exterior colors have been deleted:** Sky Blue, Mohave Beige, Royal Blue Metallic, Khaki, Spruce Blue Metallic, Apple Red, Burgundy Metallic and Steel Gray Metallic. They have been replaced by six new exterior colors for 1994: Gunmetal, Brilliant Blue Metallic, Indigo Blue Metallic, Emerald Green Metallic, Sand Beige Metallic and Victory Red.

Additional Information on Significant Features

- The **4-Speed Electronically Controlled Transmission** is standard on the Chevy Van. Electronic controls provide consistent and smooth shifts in all weather conditions, regardless of the load. The overdrive gear reduces engine speed when cruising, contributing to higher fuel efficiency and reduced engine wear.
- A new **Standard Driver-Side Facial Air Bag** supplements protection offered by the driver-side seatbelt. In the event of a moderate to severe frontal collision, sensors detect the sudden deceleration. The sensors trigger an inflator module which causes a chemical reaction, producing nitrogen gas which inflates the air bag. This all happens in less than the blink of an eye to help protect against facial and head injuries in certain frontal collisions (not available on Chevy Vans above 8,600 lbs. GVWR).
- Chevy Van offers standard **4-Wheel Anti-Lock Brakes**, which reduce the chance of wheel lockup helping driver maintain control during severe braking. When wheel sensors detect an impending lockup, the control unit modulates brake pressure to the appropriate brake lines, helping to improve steering control even on slippery surfaces.

MODELS PASSENGERS

Chevy Van CG11005	1
Chevy Van CG11305	1
Chevy Van CG21005	1
Chevy Van CG21305	1
Chevy Van CG31305	1
Extended Chevy Van CG31605	1

DIMENSIONS /SPECIFICATIONS

Wheelbase (inches)		
CG11005/CG21005	110.0	
CG11305/CG21305/CG31305	125.0	
CG31605	146.0	
Length (overall - inches)		
CG11005/CG21005	180.1	
CG11305/CG21305/CG31305	204.1	
CG31605	225.1	
Height (overall - inches)		
CG11005	30.0	
CG11305	79.9	
CG21*05		
Gas Engine	80.9	
Diesel Engine	80.5	
CG31*05	82.3	
Width (maximum - inches)		79.5
Sliding Side Load Door (inches)		
Opening Height	49.3	
Opening Width	44.2	
Swing Out Side Load Door		
Opening Height	48.5	
Opening Width	46.7	
Rear Load Door (inches)		
Opening Height	48.9	
Opening Width	54.4	
Cargo Capacity (cu. ft.)		
CG11005/CG21005	207.0	
CG11305/CG21305/CG31305	260.0	
CG31605	306.0	
Payload (pounds)		
CG11005	1681/2078	
CG11305	1541/1938	
CG21005	2668	
CG21305	2520	
CG31305	2747	
CG31605	3713	
GVWR (pounds)		
CG11*05	6000	
CG21*05	6600	
CG31305	7100	
CG31605	8600	
Fuel Tank Capacity		
CG11*05/CG21*05/CG31305	22 Gal.	
CG31605	33 Gal.	

POWER TEAMS

Standard Engine
 CG*1*05-RPO LB4 4 3L (262 Cu. In.)-V6 with Electronic Fuel Injection (EFI)
 CG31605-RPO L05 5.7L (350 Cu. In.)-V8 with Electronic Fuel Injection (EFI)
 Standard Transmission
 RPO MX0 4-Speed Electronically Controlled Automatic with Overdrive

STANDARD EQUIPMENT SUMMARY

EXTERIOR

Alternator: 100 Amps
 Battery: Heavy-duty with 600 Cold Cranking Amps
 Brake/Transmission Shift Interlock
 Brakes: Heavy-duty power front disc/rear drum brakes and 4-wheel anti-lock braking system
 Bumpers: Front and rear, painted silver with front bumper guards
 Defoggers: Side window
 Door Stop, Rear Door
 Doors: Swing-out side
 Glass, Tinted: Solar-Ray
 Grille: Molded plastic grille and front lamp bezels painted light argent
 Headlamps: Single rectangular halogen
 Mirrors: RH and LH stainless steel below-eye-line with adjustable heads, 6.5" x 9"
 Moldings: Black body side
 Shock Absorbers:
 32mm heavy-duty, front and rear (G10-G20 Series)
 35mm heavy-duty, front and rear (G30 Series)
 Springs: Heavy-duty CG11*05
 Steering, Power
 Tire, Spare: Full size spare tire and wheel (CG11*05)
 Tires:
 CG11*05
 Five P215/75R15 blackwall steel belted radial
 CG21*05
 Four P225/75R15 blackwall steel belted radial
 CG31*05
 Four LT225/75R16 blackwall steel belted radial
 Wheel Trim: Bright metal hub caps with black trim
 Wheels:
 CG11*05/CG21*05
 Five 15" x 6" argent painted steel
 CG31*05
 Five 16" x 6.5" argent painted steel
 Windshield Wipers: Intermittent

STANDARD EQUIPMENT SUMMARY (Cont'd)**INTERIOR**

Air Bag, Driver's Facial (N/A C6P or C6W GVWR)
Armrest: Padded, left hand
Carrier, Spare Wheel/Tire on RH Rear Side
Cigarette Lighter with ashtray
Coat Hook, LH
Door Guard Beams, Side (Front)
Floor Covering: Embossed black rubber mat over
entire floor area and front wheelhousing
(N/A on CG11005 or CG21005)
Gages: Engine temperature, fuel level, odometer,
oil pressure, speedometer, trip odometer, and
voltmeter
Headlamp-On Warning Buzzer
Heater: Deluxe outside air heater and defogger
Lamps: Two dome lamps with front door-actuated
switches
Parcel Tray with beverage holder provisions
Radio: Electronically tuned AM with digital clock and
fixed mast antenna
Seat Trim: Adjustable high back front bucket driver's
seat with custom vinyl trim
Stop Lamp, Center High-Mounted
Stowage Box with Latched Door
Sunshades: RH and LH vinyl, color-keyed

MODEL AND BODY

Description	Model No
2-WHEEL-DRIVE MODELS	
*16,516.00 Chevy Van.....	CG11005
*16,700.00 Chevy Van.....	CG11305
*16,485.00 Chevy Van.....	CG21005
*16,690.00 Chevy Van.....	CG21305
*16,817.00 Chevy Van.....	CG31305
*18,937.00 Ext Chevy Van.....	CG31605

*Includes Destination & Handling Charges

EMISSIONS (Must Specify One) (Refer Emission Requirements Section)

- FE9 Federal Emission Requirements
(Satisfies High Altitude Emission Requirements w/C6P or C6W)
- NA6 High Altitude Emission Requirements
- NG1 New York State Emission Requirements
- YF5 California Emission Requirements
- NB8 California or New York State Emission Override (Requires FE9 Federal or NA6 High Altitude Emissions)
- NC7 Federal or High Altitude Emission Override (Requires NG1 New York State or YF5 California Emissions)

GVWR SELECTOR (Must Specify One) (Refer VPS For Pricing)

GVWR Option Required	GVW Rating (lbs)	Minimum Equipment Required For GVW Rating		Restrictions
		(a) GAWR(lbs) Front	Rear	
MODEL CG11*05				
C5J	6000	3166	3166	Reqs LB4 or L03 Eng
MODEL CG21*05				
C5S	6600	3400	3406	Reqs LB4/L03 or L05 Eng
C6Q	6875	3670	3500	Reqs L49 or L05 Eng and FL/FM Tires (N/A CG21005)
MODEL CG31305				
C5Y	7100	3400	4380	Reqs LB4 Eng
C6C	7400	3400	4380	Reqs L05 Eng
C6P	8600	3880	5360	Reqs YHF Tires
C6W	9200	4000	5360	Reqs L05 /L19/L57 Eng and YHF Tires
MODEL CG31605				
C6P	8600	3880	5360	Reqs L05 Eng
C6P	8600	4000	5360	Reqs L19 or L57 Eng
C6W	9200	4000	5360	Reqs YHF Tires

(a) GAWR'S shown are the minimum for each axle with equipment listed. Other GAWR's are available, and they are determined as the minimum capacity of either axle, springs or tires.

POWER TEAMS (Must Specify Engine, Transmission and Rear Axle)

(Consult GVWR Selector for Minimum Equipment Required)

W/FE9 FEDERAL OR NG1 NEW YORK STATE EMISSION REQUIREMENTS

ENGINE	TRANSMISSION	AXLES					GVWR
		AUTO	3.23	3.42	3.73	(g) 4.10 (g) 4.56	
a) LB4 V6 4.3 Liter 262 Cu Inl-EFI	MX0	--	(h)GU6	b)GT4	--	--	6000
		--	(h)GU6	b)GT4	--	--	6600
		--	--	(b)GT4	--	--	7100
		--	--	--	a.)GT5	b) HC4	8600
f) L03 V8 5.0 Liter 305 Cu Inl-EFI	MX0	--	GU6	--	--	--	6000
		--	GU6	(d)GT4	--	--	6600
d) L05 V8 5.7 Liter 350 Cu Inl-EFI N/A w/C6P or C6W	MX0	--	GU6	(c)GT4	--	--	6600/6875
		--	GU5	--	--	--	7400
d) L05 V8 5.7 Liter H.D. 350 Cu Inl-EFI Reqs C6P or C6W	MX0	--	--	(a,c)GT4	GT5	--	8600/9200
e) L49 V8 6.5 Liter Diesel 400 Cu Inl	MX0	--	GU6	(c)GT4	--	--	6875
g) L19 V8 7.4 Liter 454 Cu Inl-EFI	MX0	--	GU6	GT4	GT5	--	8600/9200
g) L57 V8 6.5 Liter Diesel H.D. 400 Cu Inl	MX0	--	--	(a)GT4	GT5	--	8600
		--	--	--	GT5	--	9200

- (a) N/A CG31605
- (b) Reqs V08 Cooling
- (c) Reqs Z82 Trailering on CG21305
- (d) N/A CG11*05 or CG21005
- (e) CG21305 Only
- (f) N/A CG31*05
- (g) Reqs CG31*05
- (h) Reqs FE9 Emissions

POWER TEAMS (Continued)

(Consult GVWR Selector for Minimum Equipment Required)

W/NA6 HIGH ALTITUDE EMISSION REQUIREMENTS

ENGINE	TRANSMISSION	AXLES					GVWR
		AUTO	3.23	3.42	3.73	(g) 4.10	
d) LB4 V6 4.3 Liter 262 Cu Inl-EFI	MX0	--	(a)GU6	b)GT4	--	--	6000/6600
		--	--	(b)GT4	--	--	7100
a) L03 V8 5.0 Liter 305 Cu Inl-EFI	MX0	--	GU6	GT4	--	--	6000/6600
c) L05 V8 5.7 Liter 350 Cu Inl-EFI	MX0	--	GU6	(e)GT4	--	--	6600/6875
(c) L49 V8 6.5 Liter Diesel 400 Cu Inl	MX0	--	GU6	(e)GT4	--	--	6875
f) L57 V8 6.5 Liter Diesel H.D. 400 Cu Inl	MX0	--	--	(d)GT4	GT5	--	8600
		--	--	--	GT5	--	9200

- a) N/A CG31*05
- b) Reqs V08 Cooling
- c) CG21305 Only
- d) N/A CG31605
- e) Reqs Z82 Trailering on CG21305
- f) Reqs CG31*05

POWER TEAMS (Continued)
 (Consult GVWR Selector for Minimum Equipment Required)

W/YF5 CALIFORNIA STATE EMISSION REQUIREMENTS							
ENGINE	TRANSMISSION	AXLES				GVWR	
		3.23	3.42	3.73	(f) 4.10	(f) 4.56	
a) LB4 V6 4.3 Liter (262 Cu In)-EFI	MX0	--	--	b)GT4	--	--	6000/6600/7100
		--	--	--	a,b)GT5	b)HC4	8600
c) L03 V8 5.0 Liter (305 Cu In)-EFI	MX0	--	GU6	--	--	--	6000/6600
d) L05 V8 5.7 Liter (350 Cu In)-EFI (N/A w/C6P or C6W)	MX0	--	GU6	e)GT4	--	--	6600/6875
		GU5	--	--	--	--	7400
(d) L05 V8 5.7 Liter H.D. (350 Cu In)-EFI (Reqs C6P or C6W)	MX0	--	--	(a,e)GT4	GT5	--	8600/9200
(f) L19 V8 7.4 Liter (454 Cu In)-EFI	MX0	--	GU6	GT4	GT5	--	8600/9200
(f) L57 V8 6.5 Liter Diesel H. D. (400 Cu In)	MX0	--	--	(a)GT4	GT5	--	8600
		--	--	--	GT5	--	9200

- a) N/A CG31605
- b) Reqs V08 Cooling
- c) N/A CG31105
- d) N/A CG11105 or CG21005
- e) Reqs Z82 Trailering on CG21305
- f) Reqs CG31105

CAPACITIES

SPRINGS

CG11*05

Front: 3400 Base

Rear: 3400 Base

CG21*05

Front: 3400

Rear: 3800 Base

CG31*05

Front: 3400 w/o LB4
3900 w/C6P

Rear: 5400 Base
6000 w/C6W

AXLES

CG11*05

Front: 3400 Base

Rear: 3500 Base

CG21*05

Front: 3400

Rear: 3500 Base

CG31*05

Front: 4000 Base

Rear: 5700 Base
6000 w/C6W

TIRES (Must Specify Front, Rear and Spare Tire or Option R6Z Spare Tire not Desired) (Refer VPS For Pricing)

Description	Highway		
	Front	Rear	Spare
CG11*05			
TUBELESS STEEL BELTED RADIAL			
(a) P215/75R15 B/W	XCU	YCU	ZCU
(a) P215/75R15 W/W	XCV	YCV	ZCV
CG21*05			
TUBELESS STEEL BELTED RADIAL			
(b) P225/75R15 B/W	XET	YET	ZET
(b) P225/75R15 W/W	XEU	YEU	ZEU
(b) P225/75R15 W/L	XEV	YEV	ZEV
(c) P235/75R15 B/W	XFL	YFL	ZFL
(c) P235/75R15 W/S	XFM	YFM	ZFM
CG31*05			
TUBELESS STEEL BELTED RADIAL			
(d) LT225/75R16-D B/W	XHP	YHP	ZHP
LT225/75R16-E B/W	XHF	YHF	ZHF

- (a) N/A R6Z Spare Not Desired
- (b) Reas C5S 6600 GVWR
- (c) Reas C6Q 6875 GVWR
- (d) N/A C6P/C6W or CG31605

B/W=Blackwall
W/L=White Lettered
W/S=White Stripe
W/W=White Wall

MUST SPECIFY:
AXLE, EMISSION, ENGINE, GVWR, PEG, TRANSMISSION, AND TIRES.

No Deletions Allowed. Additional Options/Upgrades (Where Indicated)
 May be Ordered from the Additional Option Listing.

		BASE	
		GV A 1	GV A 2
N.C.	Preferred Equipment Group 1		
	Standard Body ZW9	x	x
**268.00	Preferred Equipment Group 2		
**150.00	PEG 2 Savings		
	Air Conditioning: Front (A)	C60	x
	Radio: Stereo, Seek-Scan/Clock (B)	UM7	x
	Seat: Auxiliary	AS7	x

* The Preferred Equipment Group MSRP's Reflect the Base Group Equipment Prices. For any Options, Upgrades, or Substitutions. Refer to the Vehicle Price Schedule for any Price Differential.
 ** PEG Savings Amount represents the savings for Preferred Equipment Groups.

Allowable Substitutions (Where Available):
 (A) C60: May substitute C69 Air
 (B) UM7: May substitute UM6, UX1 or U1C Radio

ADDITIONAL OPTIONS

INCL. W/ PEG	OPTION	
		ACKNOWLEDGEMENTS:
N.C.	R8S	Multiple Order Numbers
N.C.	R8T	Preliminary Invoice
		AIR CONDITIONING: (Incls R134A Refrigerant)
	2 C60	Front (Incl w/C69 Front and Rear Air; w/GVA2 w/GVA1
N.C. 975.00		
	C69	Front and Rear (Incls C60 Front Air) w/GVA2 w/GVA1
599.00 1574.00 142.00		
	V22	APPEARANCE, DELUXE FRONT
		AXLES: Rear (Refer Power Teams Chart for Availability)
N.C.	GU5	3.23 Ratio
N.C.	GU6	3.42 Ratio
N.C.	GT4	3.73 Ratio
N.C.	GT5	4.10 Ratio (Reqs CG31*05)
N.C.	HC4	4.56 Ratio (Reqs CG31305)
252.00	G80	Locking Differential
N.C.	2 ZW9	BODY CODE: Standard
76.00	V37	BUMPER EQUIPMENT: Chromed Front and Rear
48.00	V10	COLD-CLIMATE PACKAGE: (N/A L49 or L57 Diesel Engine) (Incls Engine Block Heater)
		CONVENIENCE GROUP:
434.00	ZQ2	Power Windows and AU3 Power Door Locks
383.00	ZQ3	Compass Steering Wheel and Speed Control
	V08	COOLING SYSTEM: (N/A L19, L49 or L57 Engine) (Incl w/Z82 Trailering) (Reqs LB4 or L05 Eng w/CG31305; Also Reqs L05 Eng w/CG31605) w/CG31305 and LB4 Eng w/CG31*05 and L05 Eng
N.C. 198.00		
	C49	DEFOGGER: Rear Window (Reqs ZW3 Fixed Glass Pkg or ZX6 and A12 Glass) w/ZX6 Swing-Out Glass Pkg w/ZW3 Fixed Glass Pkg or A12 Fixed RR Door Glass
95.00 154.00		
N.C.	YA2	DOOR: Sliding Door (N/A CG31605) (Swing Out Side Door is Standard)
	AU3	DOOR LOCK SYSTEM, POWER: (Incl w/ZQ2 Conv Group) w/ZQ2 Convenience Group w/o ZQ2 Convenience Group
N.C. 223.00		
		EMISSIONS:
N.C.	FE9	Federal Emission Requirements
N.C.	NA6	High Altitude Emission Requirements
	NG1	New York State Emission Requirements w/o CG11*05 w/CG11*05
N.C. 100.00		
	YF5	California Emission Requirements w/C6P or C6W w/o C6P or C6W
N.C. 100.00		
N.C.	NBB	California or New York State Emission Override (Reqs FE9 Federal or NA6 High Altitude Emissions)
N.C.	NC7	Federal or High Altitude Emission Override (Reqs NG1 New York State or YF5 California Emissions)
		ENGINES: (Refer Power Teams Chart for Availability)
	LB4	4.3 Liter (262 Cu In)-EFI V6 (Reqs V08 Cooling w/C6P and CG31305) w/o C6P w/CG31305 w/C6P & CG31305
N.C. (-865.00) 575.00		
	L03	5.0 Liter (305 Cu In)-EFI V8
	L05	5.7 Liter (350 Cu In)-EFI V8 w/CG31*05 w/CG21305
N.C. 865.00		
2870.00	L49	6.5 Liter (400 Cu In) Naturally Aspirated Diesel V8
1655.00	L57	6.5 Liter (400 Cu In) H.D. Naturally Aspirated Diesel V8
605.00	L19	7.4 Liter (454 Cu In)-EFI V8
125.00	KL5	Alternative Fuel (LPG or CNG Conversion Ready) (Reqs L05 Eng and C6P or C6W GVWR) (N/A CG31305 w/L05 Eng and GT4 Axle)
157.00	B30	FLOOR COVERING: (Reqs A57 Seat) (N/A Black Trim) (Incls Front Floor and Wheelhouse Carpeting and Front Rubber Floor Mats)
		GLASS:
144.00	A07	Full Body, 6 Windows (Reqs ZX6 or ZW3 Glass Package) (Incls A08 Glass)
90.00	ZW3	Fixed Glass Package (Incls A12 Fixed Rear Door Glass and Fixed Side Door Glass)
	A08	RH Rear Body Side Window (Reqs ZX6 or ZW3 Glass) (Incl w/A07 Glass) w/A07 Glass w/o A07 Glass
N.C. 52.00		
	A12	Rear Door, Fixed (Incl w/ZW3 Glass) (Reqs C49 w/ZX6 Glass) w/A07/ZW3 or ZX6 Glass w/o A07 or ZW3 Glass
N.C. 50.00		

ADDITIONAL OPTIONS

INCL W/PEG	OPTION	
		GLASS: (Continued)
	A18	Rear Door Swing Out (Incl w/ZX6 Glass) (N/A Z1W3 Glass) w/ZX6 Glass w/A07 Glass w/o A07 or ZX6 Glass
N.C. 59.00 109.00 226.00	ZX6	Swing Out Glass Package (Incls Swing Out Rear Door Glass w/o C49 Defogger and Swing Out Side Door Glass) w/C49 Defogger Reqs A12 Rear Door Fixed Glass
		GVWR: (Must Specify One) (All GVWR Options Contain Brake, Suspension and Chassis Enhancements To Achieve GVWR Rating) (Refer GVWR Selector Chart for Requirements)
N.C. N.C.	CSJ CSS	6000# (Reqs CG11*05) Base GVWR 6600# (Reqs CG21*05) Base GVWR
N.C. 319.00 N.C. 657.00	C6Q CSY C6C C6P	6875# (Reqs CG21305 and L05 or L49 Eng and FL*FM Tires) (Incls Price of XFL and YFL Tires Which Must Be Specified) w/L49 Eng w/o L49 Eng 7100# (Reqs CG31305 and LB4 Eng) (Incls V08 Cooling) Base GVWR 7400# (Reqs CG31305) (Incls Price of L05 Eng which Must Be Specified) 8600# (Reqs CG31*05) (Base GVWR on CG31605 Models) (Incls Price of L05 Engine which Must Be Specified, L80E Heavy Duty Electronically Controlled Transmission, Full Floating Rear Axle and Heavy Duty Emissions) w/CG31605 w/CG31305
N.C. 1032.00	C6W	9200# (Reqs CG31*05) (Incls 8600 GVWR Components Plus Load Range E Tires which Must Be Specified and Other Chassis Components to achieve GVWR Rating) w/CG31605 w/CG31305
140.00 272.00 205.00 156.00	C36 TR9	HEATER REAR LIGHTING, AUXILIARY: (Incls Headlamp Warning Buzzer, Underhood Lamp, and Front and Rear Dome Reading Lamps)
175.00 98.00	AX3 DG9	LOCK: Remote Keyless Entry System (Reqs TR9 Lighting and ZQ2 Convenience Group) (Incls Headlamp Delay) MIRROR, EXTERIOR: Below-Eye-Line Electric, Stainless Steel (Reqs ZQ2 Convenience Group and A12, A18, ZW3 or ZX6 Glass)
N.C. N.C.	B98 ZY1	MOLDING DELETE: (Reqs B3D School Bus) PAINT, EXTERIOR: Solid (Refer Color/Trim Chart for Availability)
		RADIO EQUIPMENT: (Electronically Tuned AM Radio w/Digital Clock Standard) (With Optional Radio Incls Premium Front Speakers and Wiring for Rear Speakers)
N.C. 96.00	2 UM7	Electronically Tuned AM/FM Stereo Radio w/Seek-Scan and Digital Clock w/GVA2 w/GVA1
122.00 218.00	UM6 UX1	Electronically Tuned AM/FM Stereo Radio w/Seek-Scan, Stereo Cassette Tape and Digital Clock w/GVA2 w/GVA1 Electronically Tuned AM Stereo/FM Stereo Radio w/Seek-Scan, Stereo Cassette Tape with Search and Repeat, Graphic Equalizer and Digital Clock w/GVA2 w/GVA1
272.00 368.00	U1C	Electronically Tuned AM Stereo/FM Stereo Radio w/Seek-Scan Compact Disc Player and Digital Clock w/GVA2 w/GVA1
421.00 517.00 35.00 1,95.00 65.00	U75 UL5 B3D	Radio Antenna, Power Radio Delete (Reqs GVA1) SCHOOL BUS CHASSIS EQUIPMENT: (N/A LB4 or L19 Eng) (Reqs C6W GVWR) w/L05 Eng or L57 Diesel Eng
		SEAT: (Must Specify One)
N.C. 187.00 N.C. N.C. 60.00 95.00	2 A57 YG4 X**4 NP5 NL7	Front, Auxiliary (Incls Assist Handle) w/GVA2 w/GVA1 Auxiliary Seat Not Desired (N/A w/A57 Seat or L49 Eng) (Reqs GVA1) SEAT TRIM: (Refer Trim Chart for Availability) Custom Vinyl High Back Bucket Driver's Seat STEERING WHEEL: Leather Wrapped TANK, FUEL: Approx 33-Gallon Total Vehicle Capacity (Std on CG31605) (N/A CG11*05 or CG21005) (Incl w/L49 Eng on CG21305)
N.C.	R6Z	TIRES: (Refer Tire Chart for Availability, Refer Vehicle Price Schedule for Pricing) Spare Tire Not Desired
132.00	Z72 Z82	TRAILERING SPECIAL EQUIPMENT: Light-Duty (Incls Bumper Mounted Trailer Hitch, 5-Wire Wiring Harness and HD Flasher) Heavy-Duty (Incls Platform Trailer Hitch, 7-Wire Wiring Harness and HD Flasher) (Incls V08 Cooling w/LB4, L03 or L05 Eng)
310.00 508.00		w/Diesel Eng, L19 Eng or CSY GVWR w/o Diesel Eng, L19 Eng or CSY GVWR
N.C.	MX0	TRANSMISSION: 4-Speed Electronic Automatic with Overdrive (Refer Power Teams Chart) WHEELS: (Spare is Base Steel Wheel)
42.00 121.00	P01 N67	Bright Metal, Full Cover (CG31*05 Only) Rally (N/A CG31*05)

CHEVY VAN INTERIOR AND EXTERIOR COLOR AVAILABILITY CHART WITH ZY1 PAINT

PLEASE NOTE: Below are the interior trim color and exterior paint combinations recommended by Chevrolet. The only available color code 1/color code 2 exterior color combinations are those shown in the chart below.

TRIM LEVEL Seat Type	Model Option	INTERIOR COLORS				
		Black	Blue	Garnet	Beige	Gray
Standard Interior	Std	(a) XBB4	XDD4	(a) XRR4	XUU4	XTT4
Custom Vinyl High Back Bucket Driver's Seat						

EXTERIOR COLORS w/ZY1 PAINT APPLICATION	Color Code 1	Color Code 2	RECOMMENDED INTERIOR TRIM COLORS				
BEIGE, SAND (Met)	57	57	x			x	
BLACK, ONYX	41	41	x		x	x	x
BLUE, BRILLIANT (Met)	22	22	x	x			x
BLUE, INDIGO (Met)	39	39	x	x		x	x
GREEN, EMERALD (Met)	43	43	x			x	x
GUNMETAL	14	14	x	x	x		x
QUICKSILVER (Met)	96	96	x	x	x		x
RED, MAHOGANY (Met)	33	33	x		x	x	x
RED, VICTORY	74	74	x			x	x
WHITE, SUMMIT	50	50	x	x	x	x	x

a: N/A CG31605

SOLID PAINT - ZY1

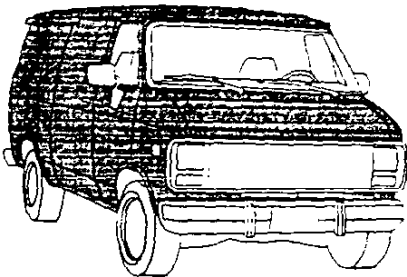

AVAILABLE SEATING ARRANGEMENTS
(See Option Section)

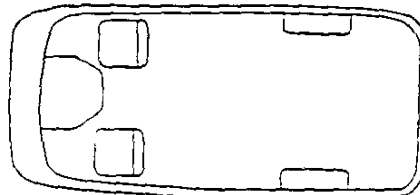

W/A57

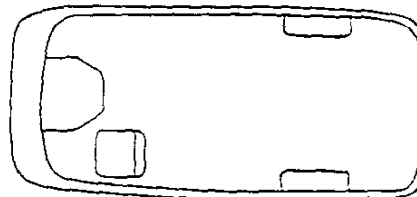

Standard

CHEVY VAN
AVAILABLE WINDOW ARRANGEMENTS
 (See Option Section for Restrictions)

STANDARD

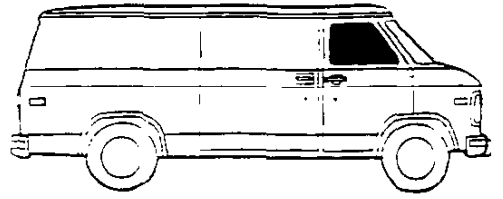
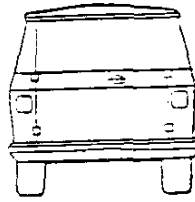
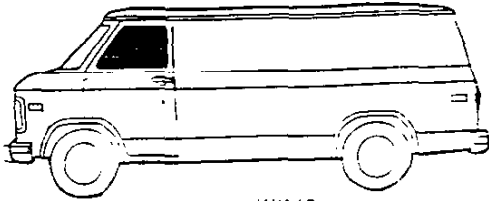

W/A12
 (Includes Fixed Rear Door Glass)

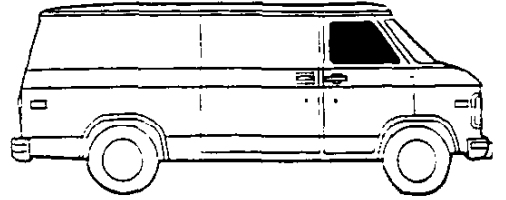
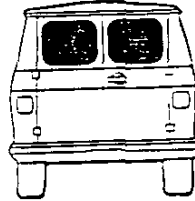
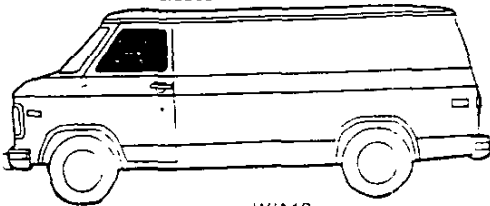

W/A18
 (Includes Swing Out Rear Door Glass)

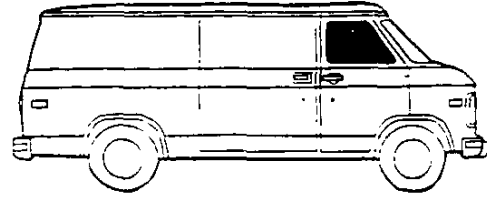
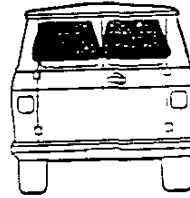
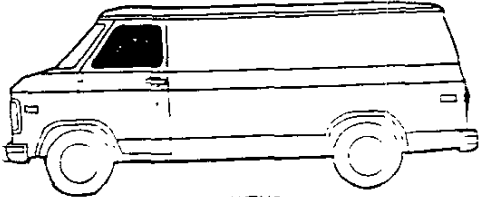

W/ZX5
 (Includes Swing Out Cargo Door and Rear Door Glass)

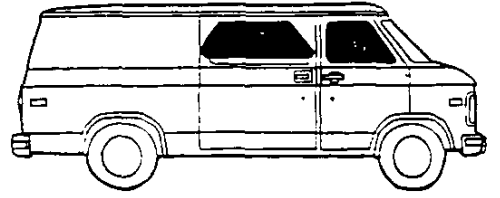
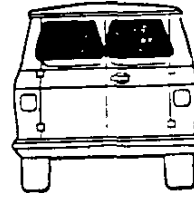
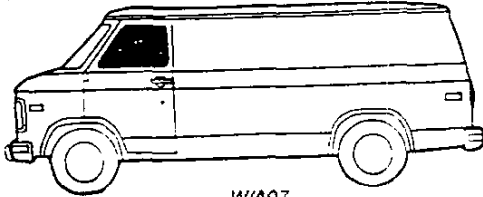

W/A07
 (Incls Rear Door Windows, Side Cargo Door Window, RH Side Quarter Windows and LH Center and Rear Quarter Windows) (Shown w/ZW3 Glass)

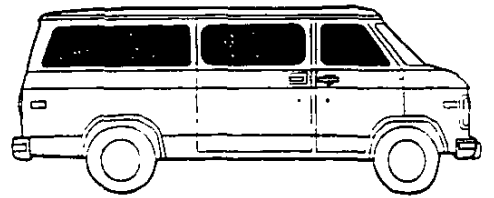
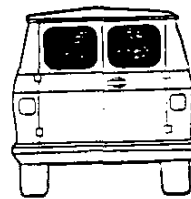
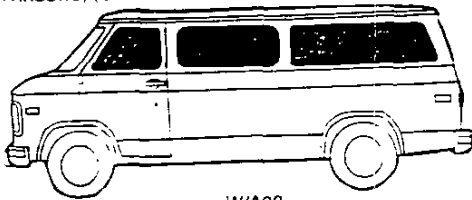

W/A08
 (Includes RH Rear Quarter Fixed Glass)
 Note: Requires ZW3/ZX6 Glass Package

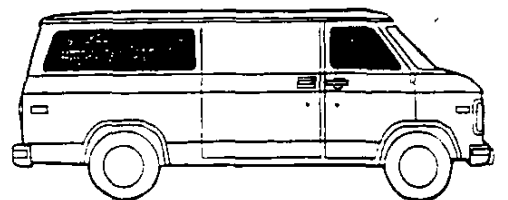
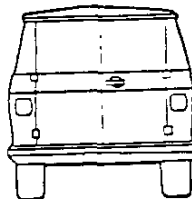
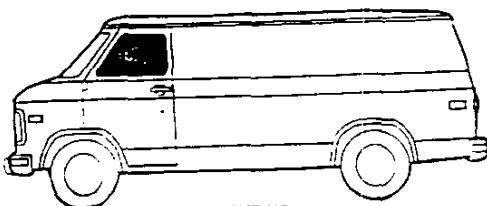

W/ZW3
 (Includes Fixed Rear Door and Fixed Cargo Door Glass)

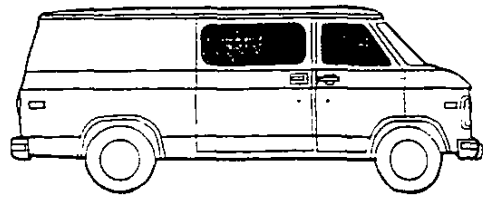
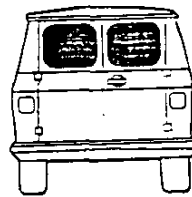
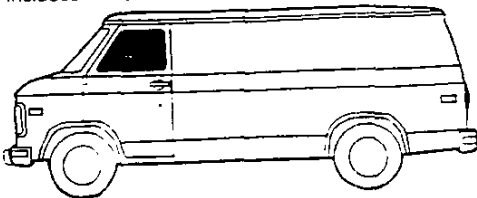

N/A CG11005 or CG11305

MUST SPECIFY:

AXLE, EMISSION, ENGINE, GVWR, PEG, TRANSMISSION, AND TIRES.
No Deletions Allowed. Additional Options/Substitutions (Where Indicated)
May be Ordered from the Additional Option Listing.

YF7 UPFITTER PACKAGE INCLUDES:

- C60** Air Conditioning (May upgrade to C69)
- V37** Bumpers: Chromed Front and Rear
- ZQ3** Convenience Package: Tilt-Wheel and Cruise
- V22** Deluxe Front Appearance Package
- BF3** Mats: Stepwell
- ZQ2** Power Windows and Locks
- UM6** Radio: AM/FM Radio/Cassette Tape/Seek and Scan (May upgrade to UX1 or U1C)
- NL7** 33 Gallon Fuel Tank (N/A CG21005)
- Electrical Junction Box and Wiring
- Rear A/C and Heater Provisions
- Rear Shoulder Belt Anchors
- Stepwell Lamps
- Temporary Driver's Seat w/LH & RH belts and risers
- Incomplete Vehicle Certification

YF7 PEGS

		RVA1	RVA2	RVA3
Upfitter Preferred Equipment Group 1				
Upfitter Package	YF7	x	x	x
Standard Body	ZW9	x	x	x
Glass: Fixed, RR Side and RR Door (A)	ZW3	x	N/I	N/I
Upfitter Preferred Equipment Group 2				
Cooling: HD (w/o Z82 Trailering, L19 or Diesel Eng)	V08		x	x
Glass: Swing-Out	ZX6		x	x
Mirrors: Exterior Electric	DG9		x	x
Mirrors: Visor, Illuminated	DH6		x	x
Steering Wheel: Leather	NP5		x	x
Wheels: Rally (B)	N67		x	N/I
Upfitter Preferred Equipment Group 3				
Glass: Deep Tinted	AJ1			x
Lock: Keyless Remote	AX3			x
Radio: AM Stereo/FM Stereo w/Clock, Cassette & Equalizer (C)	UX1			x
GVWR 6875# (CG21305 Only) (Reqs YFL or YFM Tires)	C6Q			x
Wheels, Aluminum (CG21*05 Only)	N90			x

(A) ZW3: May substitute ZX6 Glass

(B) N67: May substitute N90 Wheels on CG21*05; Incl's P01 Wheel Covers on CG31*05

(C) UX1: May substitute U1C Radio

RVA1 (-1250) *		RVA2 (-1350) *		RVA3 (-1600) *	
2712.00	CG21305 w/o L49 Eng or CG31305	3264.00	CG21005 w/o Z82	3997.00	CG21005 w/o Z82
2616.00	CG21005 or CG21305 w/L49 Eng or CG31605	3066.00	CG21005 w/Z82 or CG21305 & Diesel Eng	3799.00	CG21005 w/Z82
		3162.00	CG21305 & Gas Eng w/Z82	4412.00	CG21305 & Gas Eng w/o Z82
		3360.00	CG21305 & Gas Eng w/o Z82	4214.00	CG21305 & Diesel Eng w/o Z82 or Gas Eng w/Z82
		3083.00	CG31305 & L57 or L19 or Other Gas Eng w/Z82	3706.00	CG31305 & L57 or L19 or Other Gas Eng w/Z82
		3281.00	CG31305 & Gasoline Eng w/o Z82	3904.00	CG31305 & Gas Eng w/o Z82
		2987.00	CG31605 & L57 or L19 or Other Gas Eng w/Z82	3610.00	CG31605 & L57 or L19 or Other Gas Eng w/Z82
		3185.00	CG31605 & L05 Eng w/o Z82	3808.00	CG31605 & LB4 or L05 Eng w/o Z82

*R6J "Recreational Vehicle Group Savings"

Refer Chevy Van Order Guide Section for Emissions, Power Team and Tire Availability and Paint Selections

NOTE: FOR INFORMATION PURPOSES ONLY
YF7 UPFITTER PACKAGE AVAILABLE FOR ORDERING THROUGH
AUTHORIZED C.Q.A.C.P. MANUFACTURERS ONLY

REVISED: 1-10-94

CHEVY VAN
Page 1

Prices Shown Are Manufacturer's Suggested Retail Prices (MSRP) At The Time Of Publication. These Prices Are To Be Used Only As An Aid To Inventory Management Since MSRP Figures Change Periodically. The Vehicle Price Schedule Is The Official Pricing Documentation Of Chevrolet Motor Division And Should Be Used In Discussing Vehicle Prices With Potential Buyers. The Model Prices Shown In The Order Guide Include The Destination Freight Charges.

**YF7 UPFITTER PKG
CHEVY VAN**

ADDITIONAL OPTIONS

INCL. W/ PEG	OPTION	
		ACKNOWLEDGEMENTS:
N.C.	R8S	Multiple Order Numbers
N.C.	R8T	Preliminary Invoice
599.00	C69	AIR CONDITIONING: Front and Rear (Incls C60 Front Air) (Incls R134A Refrigerant)
		AXLES: Rear (Refer Power Teams Chart for Availability)
N.C.	GU5	3.23 Ratio
N.C.	GU6	3.42 Ratio
N.C.	GT4	3.73 Ratio
N.C.	GT5	4.10 Ratio
N.C.	HC4	4.56 Ratio
252.00	G80	Locking Differential
N.C.	1 2.3 ZW9	BODY CODE: Standard
48.00	V10	COLD-CLIMATE PACKAGE: (N/A L49 or L57 Diesel Engine) (Incls Engine Block Heater)
	V08	COOLING SYSTEM: Engine Oil Cooler (Reqs LB4 or L05 Eng w/CG31305; Also Reqs L05 Eng w/CG31605) (N/A L19, L49 or L57 Engine) (Incl w/Z82 Trailering)
N.C.		w/RVA2 or RVA3
198.00		w/RVA1
	C49	DEFOGGER: Rear Window (Reqs ZW3 Fixed Glass Pkg or ZX6 and A12 Fixed RR Door Glass)
95.00		w/RVA2 or RVA3
54.00		w/RVA1
		EMISSIONS:
N.C.	FE9	Federal Emission Requirements
N.C.	NA6	High Altitude Emission Requirements
N.C.	NG1	New York State Emission Requirements
	YF5	California Emission Requirements
N.C.		w/C6P/C6W
100.00		w/o C6P/C6W
N.C.	NB8	California or New York State Emission Override (Reqs FE9 Federal or NA6 High Altitude Emissions)
N.C.	NC7	Federal or High Altitude Emission Override (Reqs NG1 New York State or YF5 California Emissions)
		ENGINES: (Refer Power Teams Chart for Availability)
	LB4	4.3 Liter (262 Cu In)-EFI V6
N.C.		w/CSY GVWR
(-865.00)		w/C6P GVWR
575.00	L03	5.0 Liter (305 Cu In)-EFI V8
	L05	5.7 Liter (350 Cu In)-EFI V8
N.C.		w/CG31*05
865.00		w/CG21305
2870.00	L49	6.5 Liter (400 Cu In) Naturally Aspirated Diesel V8
1655.00	L57	6.5 Liter (400 Cu In) H.D. Naturally Aspirated Diesel V8
605.00	L19	7.4 Liter (454 Cu In)-EFI V8
	3 AJ1	GLASS: Deep Tinted
N.C.		w/RVA3
140.00		w/RVA1 or RVA2
N.C.	1 ZW3	Fixed Glass Package (Incls A12 Fixed Rear Door Glass and Fixed Side Door Glass) (Reqs PEG RVA1)
N.C.	A12	Rear Door, Fixed (Incl w/RVA1) (Reqs ZW3 or ZX6 Glass and C49 Defogger)
	2.3 ZX6	Swing Out Glass Package (Incls Swing Out Rear Door Glass w/o C49 Defogger and Swing Out Side Door Glass)
N.C.		w/RVA2 or RVA3
136.00		w/RVA1

ADDITIONAL OPTIONS

INCL. W/ PEG	OPTION	
		GVWR: (Must Specify One) (All GVWR Options Contain Brake, Suspension and Chassis Enhancements to Achieve GVWR Rating) (Refer GVWR Selector Chart for Requirements)
N.C.	C5S	6600# (Reqs CG21*05) BASE GVWR
3	C6Q	6875# (Reqs CG21305 and L05 or L49 Eng and "FL"/FM Tires) (Incls Price of XFL and YFL Tires which Must Be Specified)
N.C.		w/RVA3 or L49 Eng
319.00		w/RVA1 or RVA2 w/o L49 Eng
	C6P	8600# (Reqs CG31*05) (Base GVWR on CG31605 Models) (Incls Price of L05 Eng which Must Be Specified, 4L08E Heavy-Duty Electronically Controlled Transmission, Full Floating Rear Axle and Heavy-Duty Emissions)
N.C.		w/CG31605
1032.00		w/CG31305
	C6W	9200# (Reqs CG31*05) (Incls 8600 GVWR Components Plus Load Range E Tires which Must Be Specified and other Chassis Components to achieve GVWR Rating)
240.00		w/CG31605
1272.00		w/CG31305
205.00	C36	HEATER, REAR
	3	AX3 LOCK: Remote Keyless Entry System (Incls Headlamp Delay)
N.C.		w/RVA3
175.00		w/RVA1 or RVA2
		MIRRORS:
	2.3	DH6 Interior Lighted RH & LH Visor/Vanity
N.C.		w/RVA2 or RVA3
75.00		w/RVA1
	2.3	DG9 Exterior Below-Eye-Line Electric, Stainless Steel
N.C.		w/RVA2 or RVA3
98.00		w/RVA1
N.C.	B98	MOLDING DELETE: Body Side
N.C.	ZY1	PAINT, EXTERIOR: Solid (Refer Color/Trim Chart for Availability)
		RADIO EQUIPMENT (Electronically Tuned AM Radio w/Digital Clock Standard) (With Optional Radio Incls Premium Front Speakers and Wiring for Rear Speakers)
	3	UX1 Electronically Tuned AM Stereo/FM Stereo Radio w/Seek-Scan, Stereo Cassette Tape with Search and Repeat, Graphic Equalizer and Digital Clock
N.C.		w/RVA3
150.00		w/RVA1 or RVA2
	U1C	Electronically Tuned AM Stereo/FM Stereo Radio w/Seek-Scan Compact Disc Player and Digital Clock
149.00		w/RVA3
299.00		w/RVA1 or RVA2
85.00	U75	Radio Antenna, Power
	AQ8	SEAT RISERS DELETE: (Incls All Other Elements of Temporary Drivers Seat and Belt Systems)
N.C.	V**7	SEAT TRIM: (Refer Trim Chart Below for Interior Color Availability)
	2.3	NP5 STEERING WHEEL: Leather Wrapped
N.C.		w/RVA2 or RVA3
60.00		w/RVA1
	R6Z	TIRES: (Refer Tire Chart for Availability; Refer Vehicle Price Schedule for Pricing) Spare Tire not Desired
		TRAILERING SPECIAL EQUIPMENT:
	Z7Z	Light-Duty (Incls Bumper Mounted Trailer Hitch, 5-Wire Wiring Harness and HD Flasher)
132.00	Z8Z	Heavy-Duty (Incls Platform Trailer Hitch, 7-Wire Wiring Harness and HD Flasher) (Incls V08 w/LB4, L03 or L05 Eng)
310.00		w/Diesel Eng, L19 Eng or CSY GVWR
508.00		w/o Diesel Eng, L19 Eng or CSY GVWR
N.C.	MX0	TRANSMISSION: 4-Speed Electronic Automatic with Overdrive (Refer Power Teams Chart)
	3	N90 WHEELS: (Spare is Base Steel Wheel) Aluminum (N/A CG31*05)
N.C.		w/RVA3
189.00		w/RVA2
310.00		w/RVA1
	2	P01 Bright Metal, Full Cover (CG31*05 Only)
N.C.		w/RVA2 or RVA3
42.00		w/RVA1
	2	N67 Rally (N/A CG31*05)
N.C.		w/RVA2
121.00		w/RVA1

SEAT TRIM SELECTION (MUST SPECIFY ONE)

VDD7	BLUE
VRR7	GARNET
VUU7	BEIGE
VTT7	GRAY
VBB7	BLACK

(INCLUDES TEMPORARY DRIVER'S SEAT AND BELTS)

REVISED: 1-10-94

CHEVY VAN
Page 3

Prices Shown Are Manufacturer's Suggested Retail Prices (MSRP) At The Time Of Publication. These Prices Are To Be Used Only As An Aid To Inventory Management Since MSRP Figures Change Periodically. The Vehicle Price Schedule Is The Official Pricing Documentation Of Chevrolet Motor Division And Should Be Used In Discussing Vehicle Prices With Potential Buyers. The Model Prices Shown In The Order Guide Include The Destination Freight Charges.

'94 Sportvan

ORDERING INFORMATION

Focus Vehicle—G20 Regular-Body Sportvan with Beauville trim and 125" wheelbase. Sportvan's full-size and rear-wheel drive offer plenty of passenger room, and great cargo hauling and trailer towing capabilities. When equipped with PEG 4 (SVA4), the G20 represents an excellent opportunity for Sportvan sales at your dealership.

Feature Vehicle—G30 Extended-Body Sportvan with Beauville trim and 146" wheelbase (detailed on the following sheet).

■ Performance

- **4.3 Liter EFI V6 Engine with Balance Shaft**—enhanced engine smoothness, provides 155 hp/235 lb.-ft. of torque
- **Four-Wheel Anti-Lock Brake System**—reduces chance of wheel lockup helping driver maintain control during severe braking, even on slippery surfaces
- **Four-Speed Electronically Controlled Automatic Transmission with Overdrive**—coordinates engine speed with vehicle load for smooth, consistent shifts whether carrying small payload or towing trailer

■ Options

- **Engine Choices**—a wide range of engines are available for every job from hauling kids to hauling large trailers. Including standard 4.3 Liter V6, gasoline 5.0 Liter, 5.7 Liter, 7.4 Liter V8s, and two new naturally aspirated 6.5 Liter diesel V8s
- **Trim Levels**—choice of standard Sportvan or Beauville decor offers a wide range of comfort, appearance and convenience features, including additional seating for up to fifteen passengers
- **Volume and Payload**—choice of 125" or 146" wheelbase provides enclosed cargo lengths, volumes, payload and passenger capacities for a variety of needs

■ Work Credentials

- **Trailer Towing**—G20 can tow up to 7,000 lbs. when properly equipped (a properly equipped G30 can tow up to 10,000 lbs.)
- **Swingout Side Cargo Door**—permits easy access to cargo area
- **High Carrying Capacity**—payload up to 2,142 lbs. for properly equipped G20 (3,476 lbs. for properly equipped G30 extended-body)
- **Cargo Capacity**—up to 260 cu. ft. of cargo room with 125" wheelbase (up to 306 cu. ft. with extended-body)

■ Easy

- TO OWN**
- **Scotchgard™ Fabric Protector**—on cloth seats, door panels and carpet, resists stains for easy cleanup
- **Solar-Ray Tinted Glass**—screens out much of the sun's ultraviolet and infrared rays to help keep interior cool, helps reduce fading and deterioration of interior fabrics/trim
- ON THE MIND**
- **Standard Driver-Side Facial Air Bag**—in conjunction with seat belts, helps protect against facial and head injuries in certain frontal collisions (not available on Sportvans above 8,600 lbs. GVWR)
- **Center High-Mounted Stop Lamp**—highly visible signal helps reduce chance of rear end collisions
- **Roadside Assistance**—24-hour service assistance via Chevrolet's toll-free "800" number. Fast response for towing, repairs and other services

■ Reliability/Durability

- **Two-Sided Galvanized Steel**—outer body panels (except roof) resist corrosion
- **Maintenance-Free Battery**—heavy duty Delco battery offers high cranking power for quick, reliable starts
- **Bumper-to-Bumper Plus Warranty**—3-year/36,000-mile, no-deductible limited warranty, includes parts and labor, 6-year/100,000-mile body sheet metal rust-through protection, 5-year/50,000-mile emissions control system coverage. (Tires covered by their manufacturer.)
- **Chevrolet Diesel Engine Warranty**—5-year/100,000-mile warranty, \$100 deductible after 3 years/36,000 miles

FEATURE VEHICLE: G30 EXTENDED-BODY SPORTVAN



RED ■ : New Feature
BLACK ■ : Focus Vehicle Feature



FOCUS
VEHICLE:
G20
REGULAR-
BODY
SPORTVAN

G34 Sportvan

Trim Color/Seat Style Availability

Custom Vinyl
available in Blue, Garnet,
Beige and Gray.

Custom Cloth
available in Blue, Garnet,
Beige and Gray.

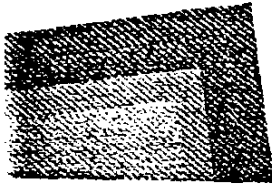
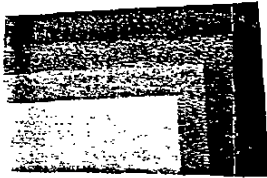

High-Back Bucket Seats -
Standard Model and Beauville

High-Back Bucket Seats -
Beauville

Reclining High-Back Bucket
Seats - Beauville

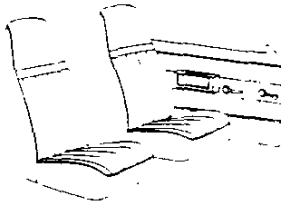
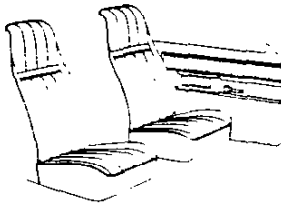

Four Most Popular Exterior Colors By Percentage

Below are the anticipated four most popular Sportvan colors for 1994 based on national sales volume. They are listed for reference only. To identify the top selling colors in your area, by model, use the Retail Sales Analysis (RSA).

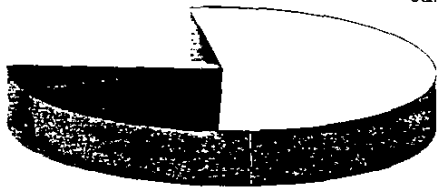

Summit White	54%
Indigo Blue Metallic	10%
Brilliant Blue Metallic	8%
Mahogany Red Metallic	6%

Four Most Popular Exterior Colors with Corresponding Interior Color Availability

EXTERIOR	INTERIOR			
	Blue	Garnet	Beige	Gray
Summit White	■		■	■
Indigo Blue Metallic	■		■	■
Brilliant Blue Metallic	■			■
Mahogany Red Metallic		■	■	■

NOTE: New Sportvan exterior colors are Gunmetal, Brilliant Blue Metallic, Indigo Blue Metallic, Emerald Green Metallic, Sand Beige Metallic and Victory Red.

Wheels



Standard 15" x 6"
steel - painted Argent - G20



Standard 16" x 6.5"
steel - painted Argent - G30

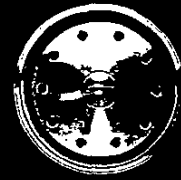

Optional
Bright metal full wheel cover - G30

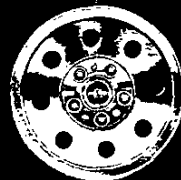

Optional cast-aluminum wheel
(not available on G30 series)



Optional Rally Wheel
(not available on G30 series)

'94 Sportvan

Forecasted Percent of Mix

Series	
G20 125"	40%
G30 125"	20%
G30 146"	40%
Total	100%
Doors	
Swingout Side	90%
Sliding	10%
Total	100%
Trim Levels	
Standard	35%
Beauville	65%
Total	100%
Engines	
4.3L V6 EFI	5%
5.0L V8 EFI	5%
5.7L V8 EFI	80%
6.5L V8 Diesel	3%
6.5L V8 Diesel HD	4%
7.4L V8 EFI	3%
Total	100%
Transmissions	
4-Speed Electronically Controlled Automatic with Overdrive	100%
Total	100%

Additional Information on Significant Features

- Sportvan offers standard **4-Wheel Anti-Lock Brakes**, which reduce the chance of wheel lockup helping driver maintain control during severe braking. When wheel sensors detect an impending lockup, the control unit modulates brake pressure to the appropriate brake lines, helping to improve steering control even on slippery surfaces.
- A **Four-Speed Electronically Controlled Automatic Transmission with Overdrive** is standard. The electronic components reduce unit-to-unit manufacturing variability, providing more consistent operation. A Powertrain Control Module (PCM) manages the shifting by coordinating vehicle load with engine speed, resulting in smooth, consistent shifts under all operating conditions.
- The optional **6.5 Liter naturally aspirated diesel V8** is offered in two versions. The light duty version is for Sportvans rated below 8,500 lbs. GVW. Its designation is RPO L49, while the heavy duty version for Sportvans rated above 8,500 lbs. GVW is the L57. All new for 1994, the L57 features the first use of a serpentine accessory belt drive system on full-size GM van and P-truck diesel engines. Its combustion chamber was specifically designed for smokeless, low emission operation. The 6.5 Liter features power and fuel economy, combined with high reliability and durability.
- The G20 offers a base seating arrangement of 8 passengers with a seat delete option for 5-passenger seating. The G30 with 125" wheelbase has 12-passenger seating with an available seat delete option for 8-passenger seating.

Deletions:

- **G-10 Sportvan has been eliminated.** The series continues with the higher capacity G20 and G30 models. To meet the minimum load capacity requirements, **P205/75R-15 tires have been replaced by the P225/75R-15.**
- **The 6.5 Liter Naturally Aspirated V8 Diesel Engine in both Light Duty and Heavy Duty versions replaces the 6.2 Liter V8 Diesels** offered in 1993. They offer improvements in power, reliability and durability.
- **Base vinyl trim is replaced by Custom vinyl** as standard.
- **Eight exterior colors have been deleted:** Sky Blue, Mohave Beige, Royal Blue Metallic, Khaki, Spruce Blue Metallic, Apple Red, Burgundy Metallic and Steel Gray Metallic. They have been replaced by six new exterior colors for 1994: Gunmetal, Brilliant Blue Metallic, Indigo Blue Metallic, Emerald Green Metallic, Sand Beige Metallic and Victory Red.
- **ZY4 two-tone paint replaced by ZY2.** New paint break-line provides an updated look.

MODELS PASSENGERS

Sportvan CG21306	8
Sportvan CG31306	12
Sportvan Extended Van CG31606	12

DIMENSIONS / SPECIFICATIONS

Wheelbase (inches)	
CG21306/CG31306	125.0
CG31606	146.0
Length (overall - inches)	
CG21306/CG31306	204.1
CG31606	225.1
Height (overall - inches)	
CG21306	79.5
CG31306	
7400 GVWR	81.8
8600 GVWR	81.9
CG31606	82.3
Width (maximum - inches)	
CG21306/CG31306	79.5
Sliding Side Load Door (inches)	
CG21306/CG31306	
Opening Height	48.5
Opening Width	44.2
Swing-Out Side Load Door (inches)	
Opening Height	48.5
Opening Width	46.7
Large Door	31.0
Small Door	22.0
Rear Load Door (inches)	
Opening Height	48.8
Opening Width	54.4
Payload (pounds)	
CG21306	2016
CG31306	2155/3501/3897
CG31606	2946/4049
GVWR (pounds)	
CG21306	6600/6875
CG31306	7400/8600/9200
CG31606	8600/9200
Fuel Tank Capacity	
CG21306	33 Gal

POWER TEAMS**Standard Engine****CG21306**

RPO LB4 4.3L (262 Cu. In.) - V6 with Electronic Fuel Injection (EFI)

CG31'06

RPO L05 5.7 Liter (350 Cu. In.) - V8 with Electronic Fuel Injection (EFI)

Standard Transmission

RPO MX0 4-Speed Electronically Controlled Automatic with Overdrive

STANDARD EQUIPMENT SUMMARY**EXTERIOR**

Alternator: 100 amps
 Battery: Heavy-duty with 600 Cold Cranking Amps
 Brake/Transmission Shift Interlock
 Brakes: Heavy-duty power front disc/rear drum brakes and 4-wheel anti-lock braking system
 Bumpers: Front and rear, chrome with front bumper guards
 Defoggers: Side window
 Door Stop, rear door
 Doors: Swing-out side load door
 Glass: Side door, swing-out rear coors, side load doors, swing-out front quarter glass and LH and RH rear quarter fixed glass
 Glass, Tinted: Solar-Ray
 Grille: Molded plastic grille painted light argent
 Headlamps: Single rectangular halogen
 Mirrors: RH and LH stainless steel below-eye-line with adjustable heads, 6.5" x 9"
 Moldings: Black body side
 Shock Absorbers:
 32mm heavy-duty, front and rear (G20 Series)
 35mm heavy-duty, front and rear (G30 Series)
 Springs, Rear: Heavy-duty
 Steering, Power
 Tires:
CG21306
 Four P225/75R15 blackwall steel belted radial with gasoline engine
 Four P235/75R15 blackwall steel belted radial with diesel engine
CG31'06
 Four LT225/75R16-D blackwall steel belted radial with gasoline engine
 Four LT225/75R16-E blackwall steel belted radial with diesel engine
 Wheel Trim: Bright metal hub caps with black trim
 Wheels:
CG21306
 Five 15" x 6" argent painted steel
CG31'06
 Five 16.0" x 6.5" argent painted steel
 Windshield Wipers: intermittent

INTERIOR

Air Bag, Driver's Facial (N/A w/C6P or C6W)
 Armrests: Padded RH and LH side door and rear seat
 Assist Handle: Back of passenger seat
 Carrier, Spare Tire on RH rear side
 Cigarette Lighter
 Coat Hooks, LH
 Door Guard Beams, Side (Front)
 Door Trim Panels: Color-keyed cloth on doors and sidewalls and carpeting on lower areas
 Floor Covering: Embossed black rubber mats over entire floor area and front wheelhousing
 Gages: Engine temperature, fuel level, odometer, oil pressure, speedometer, trip odometer and voltmeter
 Headlamp-on warning buzzer

STANDARD EQUIPMENT SUMMARY**INTERIOR (Continued)**

Headliner: Full Length, with garnish moldings
 Heater: Deluxe outside air heater and defogger
 Insulation and sound-deadening material under
 instrument and front floor panels and engine cover
 Lamps: Front and rear dome lamps with door-actuated
 switches
 Parcel Tray with beverage holder provisions
 Radio: Electronically tuned AM with digital clock and
 fixed mast antenna
 Scotchgard Fabric Protector on cloth trims, door panels
 and carpeting
 Seat Trim: Adjustable high-back bucket seats and
 two removable 3-passenger bench seats with custom
 vinyl trim
 Seating:
CG21306
 8-Passenger
CG31*06
 12-Passenger
 Stop Lamp, Center High-Mounted
 Sunshades: RH and LH vinyl, color-keyed

**OPTIONAL UPLEVEL TRIM
BEAUVILLE TRIM LEVEL (RPO E94)**

The following equipment is in addition to or replacing
 items included in the base trim level.

EXTERIOR

Front Appearance: Deluxe
 Grille: Chrome
 Headlamps: Dual halogen hi-beam
 Moldings: Black body side and rear with bright inserts;
 chrome wheel opening
 Nameplate: Beauville

INTERIOR

Coat Hooks: LH and RH and rear
 Floor Covering: Color-keyed carpeting over entire floor
 area with color-keyed rubber front and rear floor mats
 Headliner: Full length cloth with garnish moldings
 Lamps: Front and rear dome with door actuated switches
 and front reading lamp
 Mats, Stepwell: Embossed, black rubber
 Mirror, Visor
 Rear Door Trim Panels: Color-keyed cloth on doors and
 carpeting on lower areas
 Spare Tire Cover
 Storage Compartment: Locking, located under passenger
 seat

MODEL AND BODY

Description	Model No
2-WHEEL-DRIVE MODELS	
*19,455.00 Sportvan	CG21306
*20,807.00 Sportvan	CG31306
*21,963.00 Extended Sportvan	CG31606

*Includes Destination & Handling Charges

EMISSIONS (Must Be Specified) (Refer Emission Requirements Section)

FE9 Federal Emission Requirements

NA6 High Altitude Emission Requirements

NG1 New York State Emission Requirements

YF5 California Emission Requirements

NB8 California or New York State Emission Override (Requires FE9 Federal or NA6 High Altitude Emissions)

NC7 Federal or High Altitude Emission Override (Requires NG1 New York State or YF5 California Emissions)

GVWR SELECTOR (Must Specify One) (Refer VPS For Pricing)

GVW Option Required	GVW Rating (lbs)	Minimum Equipment Required For GVW Rating		Restrictions
		(a) Front	GAWR (lbs) Rear	
MODEL CG21306				
C5S	6600	3400	3406	N/A L49 Eng or *FL Tires
C6Q	6875	3600	3500	Reqs L49 or L05 Eng and *FL Tires
MODEL CG31306				
C6C	7400	3400	4380	Reqs L05 Eng
C6P	8600	3800	5360	Reqs YHF Tires
C6W	9200	4000	5360	Reqs YHF Tires
MODEL CG31606				
C6P	8600	3880	5360	Reqs YHF Tires (N/A ZP3 Seating w/L19/L57 Eng)
C6W	9200	4000	5360	Reqs YHF Tires; L57 Eng Reqs ZP3 Seating

(a) GAWR'S shown are the minimum for each axle with equipment listed. Other GAWR'S are available, and they are determined as the minimum capacity of either axle, springs or tires.

CAPACITIES

SPRINGS:			AXLES:		
Front			Front		
3400	w/C5S		3400	w/C5S	
3670	w/C6Q		3675	w/C6Q	
3900	w/C6P		4000	Base	
4000	w/C6W				
Rear			Rear		
3800	CG21306		3500	CG21306	
5400	w/C6C or C6P		5700	w/C6C or C6P	
6000	w/C6W		6000	w/C6W	

REVISED: 1-10-94

1994 ORDER GUIDE

SPORTVAN
Page 3

Prices Shown Are Manufacturers Suggested Retail Prices (MSRP) At The Time Of Publication. These Prices Are To Be Used Only As An Aid To Inventory Management Since MSRP Figures Change Periodically. The Vehicle Price Schedule Is The Official Pricing Documentation Of Chevrolet Motor Division And Should Be Used In Discussing Vehicle Prices With Potential Buyers. The Model Prices Shown In The Order Guide Include The Destination Freight Charges.

POWER TEAMS (Must Specify Engine, Transmission and Rear Axle)

(Consult GVWR Selector for Minimum Equipment Required)

ENGINE	TRANSMISSION	AXLES				GVWR
		3.23	3.42	3.73	4.10	
CG21306						
L84 V6 4.3 Liter (252 Cu In)-EFI	MX0	--	GU6	(d) GT4	--	6600
(e) L03 V8 5.0 Liter (305 Cu In)-EFI	MX0	--	GU6	(c) GT4	--	6600
L05 V8 5.7 Liter (350 Cu In)-EFI	MX0	--	GU6	(c) GT4	--	6600/6875
(e) L49 V8 6.5 Liter Diesel (400 Cu In)	MX0	--	GU6	(c) GT4	--	6875
CG31*06						
L05 V8 5.7 Liter (350 Cu In)-EFI	MX0	GU5	--	--	--	7400
L05 V8 5.7 Liter H.D. (350 Cu In)-EFI	(a) MX0	--	--	(b) GT4	GT5	8600/9200
(a) L19 V8 7.4 Liter (454 Cu In)-EFI	MX0	--	GU6	GT4	GT5	8600/9200
L57 Diesel 6.5 Liter V8 (400 Cu In)	MX0	--	--	(b)GT4	GT5	8600/9200

- (a) N/A NA6 High Altitude Emission Equipment as FE9 Federal Emission Satisfies NA6 Requirements at 8600 GVWR or Greater
 (b) N/A CG31606 or C6W
 (c) Reas Z82 Trailering
 (d) Reas V08 Cooling
 (e) N/A YF5 Emissions

TIRES: Must Specify Front, Rear and Spare Tire or Option R6Z (Spare Tire not Desired) (Refer VPS For Pricing)

Description	Highway		
	Front	Rear	Spare
CG21306			
TUBELESS STEEL BELTED RADIAL			
(a) P225/75R15 B/W	XET	YET	ZET
(a) P225/75R15 W/W	XEU	YEU	ZEU
(a) P225/75R15 W/L	XEV	YEV	ZEV
(b) P235/75R15 B/W	XFL	YFL	ZFL
CG31*06			
TUBELESS STEEL BELTED RADIAL			
(c) LT225/75R16-D B/W	XHP	YHP	ZHP
LT225/75R16-E B/W	XHF	YHF	ZHF

- (a) N/A L49 Eng
 (b) Reas C60 GVWR
 (c) N/A CG31606. w/CG31306 Reas L05 Eng and C6C GVWR

B/W = Blackwall
 W/L = White Lettered
 W/W = Whitewall

INCLUDES STANDARD SEATING AS FOLLOWS:
 8 PASSENGER SEATING.....CG21306
 12 PASSENGER SEATING.....CG31*06

MUST SPECIFY:

AXLE, EMISSION, ENGINE, GVWR, PEG, TRANSMISSION, AND TIRES.

No Deletions Allowed. Additional Options/Upgrades (Where Indicated)
 May be Ordered from the Additional Option Listing.

		BASE		BEAUVILLE	
		S V A 1	S V A 2	S V A 3	S V A 4
N.C.	Preferred Equipment Group 1				
	Standard Body ZW9	x	x	N/A	N/A
**1116.00	Preferred Equipment Group 2				
**(-150.00)	PEG 2 Savings				
	Air Conditioning: Front (A) C60		x	x	N/A
	Radio: Stereo, Seek-Scan/Clock (B) UM7		x	x	N/A
*2927.00	Preferred Equipment Group 3				
**(-1150.00)	PEG 3 Savings				
	Body: Beauville E94			x	x
	Convenience Group: Power Windows and Power Door Locks ZQ2			x	x
	Convenience Group: Speed Control and Tilt Wheel ZQ3			x	x
	Lighting: Auxiliary TR9			x	x
*4575.00	Preferred Equipment Group 4 (SVA4 N/A CG31606 w/ZP3 Seat)				
	w/CG21306				
*4496.00	w/CG31*06				
**(-1350.00)	PEG 4 Savings				
	Air Conditioning: Front and Rear C69				x
	Glass: Deep Tinted AJ1				x
	Mirrors: Remote Controlled, Stainless Steel DG9				x
	Radio: Stereo, Seek-Scan/Cassette/Clock (C) UM6				x
	Reclining Front Seats w/Armrests K**6				x
	Wheels: Rally (CG21306 Only) (D) N67				x
	Wheel Covers: (CG31*06 Only) P01				x

* The Preferred Equipment Group MSRP's Reflect the Base Group Equipment Prices. For any Options, Upgrades, or Substitutions, Refer to the Vehicle Price Schedule for any Price Differential.
 ** PEG Savings Amount represents the savings for Preferred Equipment Groups.

- (A) C60: May substitute C69 Air
 (B) UM7: May substitute UM6 UX* or U1C Radio
 (C) UM6: May substitute UX1 or U1C Radio
 (D) N67: May substitute N90 Aluminum Wheels

ADDITIONAL OPTIONS

INCL w/PEG OPTION			
N.C.		R8S	ACKNOWLEDGEMENTS:
N.C.		R8T	Multiple Order Numbers
			Preliminary Invoice
	2.3	C60	AIR CONDITIONING: (Incls R134A Refrigerant)
N.C.			Front (Incl w/C69 Front and Rear Air) (Incls HD Cooling)
975.00			w/SVA2, SVA3 or SVA4
	4	C69	Front and Rear (Incls C60 Front Air) (N/A ZP3 Seating)
N.C.			w/SVA4
599.00			w/SVA2 or SVA3
1574.00			w/SVA1
			AXLES: Rear (Refer Power Teams Chart for Availability)
N.C.		GU5	3.23 Ratio
N.C.		GU6	3.42 Ratio
N.C.		GT4	3.73 Ratio
N.C.		GT5	4.10 Ratio
252.00		G80	Locking Differential
N.C.	1.2	ZW9	BODY CODE: Standard
48.00		V10	COLD-CLIMATE PACKAGE: (Incls Engine Block Heater) (N/A L57 or L49 Diesel Eng)
	3.4	ZQ2	CONVENIENCE GROUP:
N.C.			Power Windows and AU3 Power Door Locks
434.00			w/SVA3 or SVA4
	3.4	ZQ3	w/SVA1 or SVA2
N.C.			Comfort Steering Wheel and Speed Control
383.00			w/SVA3 or SVA4
198.00			w/SVA1 or SVA2
		V08	COOLING SYSTEM: (N/A L19, L57 or L49 Diesel Eng) (Incl w/ZB2 Trailering w/L05, L03 or LB4 Eng)
95.00		C49	(Reqs L05 Eng w/CG31'06)
N.C.		YA2	DEFOGGER: Rear Window (Incls Fixed Rear Door Glass)
		AU3	DOOR: Sliding Side Door (N/A CG31606) (Swing Out Side Door Standard)
N.C.			DOOR LOCK SYSTEM, POWER: (Incl w/ZQ2 Conv Group)
223.00			w/ZQ2 Conv Group
			w/o ZQ2 Conv Group
			EMISSIONS:
N.C.		FE9	Federal Emission Requirements
N.C.		NA6	High Altitude Emission Equipment
N.C.		NG1	New York State Emission Requirements
		YF5	California Emission Requirements
N.C.			w/C6P or C6W
100.00			w/o C6P or C6W
N.C.		NB8	California or New York State Emission Override (Reqs FE9 Federal or NA6 High Altitude Emissions)
N.C.		NC7	Federal or High Altitude Emission Override (Reqs NG1 New York State or YF5 California Emissions)
			ENGINES: (Refer Power Teams Chart for Availability)
N.C.		LB4	V6 4.3 Liter (262 Cu In)-EFI (CG21306)
575.00		L03	V8 5.0 Liter (305 Cu In)-EFI (CG21306)
		L05	V8 5.7 Liter (350 Cu In)-EFI
N.C.			w/CG31'06
865.00			w/CG21306
2870.00		L49	V8 6.5 Liter (400 Cu In) Diesel Naturally Aspirated (Reqs SVA1 or SVA2 on CG21306)
1655.00		L57	V8 6.5 Liter (400 Cu In) H.D. Diesel Naturally Aspirated (CG31'06)
605.00		L19	V8 7.4 Liter (454 Cu In)-EFI (CG31'06)
125.00		KL5	Alternative Fuel (LPG or CNG Conversion Ready) (Reqs L05 Eng and C6P or C6W GVWR) (N/A CG31306 w/L05 Eng and GT4 Axle)
	4	AJ1	GLASS: Deep Tinted
N.C.			w/SVA4
380.00			w/SVA1, SVA2 or SVA3
			GVWR: (Must Specify One) (All GVWR Options Contain Brake, Suspension and Chassis Enhancements To Achieve GVWR Rating) (Refer GVWR Selector Chart for Requirements)
N.C.		C5S	6600# (Reqs CG21306) Base GVWR
		C6Q	6875# (Reqs CG21306 and L05 or L49 Eng and "FL"/FM Tires) (Incls Price of XFL & YFL Tires Which Must Be Specified)
N.C.			w/L49 Eng
319.00			w/L05 Eng
N.C.		C6C	7400# (Reqs CG31306)
		C8P	8600# (Reqs CG31'06) (L19/L57 Eng w/CG31606 N/A ZP3 Seating)
N.C.			Base GVWR on CG31606 Models
251.00			w/CG31606
			w/CG31306
		C6W	9200# (Reqs CG31'06) (Incls 8600 GVWR Components Plus Load Range E Tires Which Must Be Specified and Other Chassis Components to achieve GVWR Rating)
240.00			w/CG31606
371.00			w/CG31306

ADDITIONAL OPTIONS

INCL w/PEG OPTION			
205.00		C36	HEATER, REAR SEAT
N.C.	3,4	TR9	LIGHTING, AUXILIARY: (Incls Underhood Lamp and Front and Rear Dome and Reading Lamps) w/SVA3 or SVA4 w/SVA1 or SVA2
156.00		AX3	LOCK: Remote Keyless Entry System (Reqs TR9 Lighting and ZQ2 Conv Group) (Incls Headlamb Delay)
175.00		DG9	MIRROR, EXTERIOR: Below-Eye-Line Electric, Stainless Steel (Reqs ZQ2 Convenience Group) w/SVA4 w/SVA1, SVA2 or SVA3
N.C.		DH6	MIRROR, INTERIOR: Lighted RH & LH Visor/Vanity (Reqs SVA3 or SVA4) (CG31'06 w/L57 Eng Reqs ZP3 Seating)
98.00		ZY1	PAINTS, EXTERIOR: Solid (Refer Color/Trim Chart for Availability)
75.00			RADIO EQUIPMENT (Electronically Tuned AM Radio w/Digital Clock Standard) (With Optional Radio and w/o E94 Beauville Incls Two Premium Front Speakers and Wiring for Rear Speakers) (With Optional Radio and w/E94 Beauville Incls Two Premium Front Speakers and Dual Extended Range Rear Speakers)
N.C.	2,3	UM7	Electronically Tuned AM/FM Stereo Radio w/Seek-Scan and Digital Clock w/SVA2 or SVA3 w/SVA1
141.00	4	UM6	Electronically Tuned AM/FM Stereo Radio w/Seek-Scan, Stereo Cassette Tape and Digital Clock w/SVA4 w/SVA2 or SVA3 w/SVA1
N.C.		UX1	Electronically Tuned AM Stereo/FM Stereo Radio w/Seek-Scan, Stereo Cassette Tape with Search and Repeat, Graphic Equalizer and Digital Clock w/SVA4 w/SVA2 or SVA3 w/SVA1
150.00		U1C	Electronically Tuned AM Stereo/FM Stereo Radio w/Seek-Scan, Compact Disc Player and Digital Clock w/SVA4 w/SVA2 or SVA3 w/SVA1
272.00		U75	Radio Antenna, Power (w/CG31606 and E94 w/L57 Eng Reqs ZP3 Seating)
413.00		UL5	Radio Delete (Reqs SVA1)
274.00			SEATING, REAR: (8 PASSENGER SEATING STD CG21306) (12 PASSENGER SEATING STD CG31'06)
396.00		ZP3	Additional Four Passenger Thrd Seat (15 Passenger) (CG31606 Only) (N/A C69 Front and Rear Air or Z82 Trailing) (N/A SVA4) Auxiliary Seat Not Desired (N/A w/ZP3 or CG31606)
537.00		YG4	w/CG21306 Provides 5-Passenger Seating w/CG31306 Provides 6-Passenger Seating (N/A C6C GVWR)
85.00			SEAT TRIM: (Refer Trim Chart for Availability)
(-95.00)		X**4	Custom Vinyl High Back Bucket Seats
371.00		K**4	Custom Cloth High Back Bucket Seats
		K**6	Custom Cloth Reclining Bucket Seats w/SVA4 w/o SVA4
N.C.		NP5	STEERING WHEEL: Leather Wrapped (CG31'06 w/E94 Decor and L57 Eng Reqs ZP3 Seating)
402.00			TIRES: (Refer Tire Chart for Availability; Vehicle Price Schedule for Pricing)
50.00		R6Z	Spare Tire Not Desired
			TRAILERING SPECIAL EQUIPMENT:
132.00		Z72	Light Duty (Incls Bumper Mounted Trailer Hitch, 5-Wire Wiring Harness and HD Flasher)
		Z82	Heavy-Duty (Incls Platform Mounted Trailer Hitch, 7-Wire Wiring Harness and HD Flasher) (Incls V08 Cooling w/LB4, L03 or L05 Eng) (N/A ZP3 Seating w/CG31606) w/Diesel Eng or L19 Eng w/o Diesel Eng or L19 Eng
310.00		MX0	TRANSMISSION: 4-Speed Electronically Controlled Automatic with Overdrive (Refer Power Teams Chart for Availability)
508.00			WHEELS: (Spare is Base Steel Wheel)
N.C.		N90	Aluminum (CG21306 Only) w/SVA4 w/o SVA4
189.00			Wheel Covers: Bright Metal, Full Cover (N/A CG21306)
310.00	4	P01	w/SVA4 w/SVA1, SVA2 or SVA3
N.C.	4	N67	Rally (N/A G31'06) w/SVA4 w/SVA1, SVA2 or SVA3
42.00			
N.C.			
121.00			

SPORTVAN INTERIOR AND EXTERIOR COLOR AVAILABILITY CHART WITH ZY1

PLEASE NOTE: Below are the interior trim color and exterior paint combinations recommended by Chevrolet. The only available color code 1/color code 2 exterior color combinations are those shown in the chart below.

TRIM LEVEL Seat Type	Model Option	INTERIOR COLORS			
		Blue	Garnet	Beige	Gray
STANDARD INTERIOR Custom Vinyl High Back Bucket Seats	S16	XDD4		XUU4	
BEAUVILLE Custom Vinyl High Back Bucket Seats Custom Cloth High Back Bucket Seats Custom Cloth Reclining High Back Bucket Seats	E94	XDD4	* YRR4	XUU4	XTT4
		KDD4	* KRR4	XUU4	KTT4
		KDD6	* KRR6	XUU6	KTT6

EXTERIOR COLORS w/ZY1 or ZY2 PAINT APPLICATION	Color Code 1	Color Code 2	RECOMMENDED INTERIOR TRIM COLORS			
BEIGE, SAND (Met)	57	57			x	
BLACK, ONYX	41	41		x	x	x
BLUE, BRILLIANT (Met)	22	22	x			x
BLUE, INDIGO (Met)	39	39	x		x	x
GREEN, EMERALD (Met)	43	43			x	x
GUNMETAL	74	74	x	x		x
QUICKSILVER (Met)	96	96	x	x		x
RED, MAHOGANY (Met)	80	80		x	x	x
RED, VICTORY	71	71			x	x
WHITE, SUMMIT	50	50	x	x	x	x

AVAILABLE SEAT ARRANGEMENTS (See Option Section)



5-Passenger Seating
w/YG4 on CG21306



Standard 8-Passenger Seating
CG21306 or w/YG4 on CG31306



12-Passenger Seating
on CG31'06



15-Passenger Seating W/ZP3
on G31606 Extended Model

PAINT APPLICATION

SOLID PAINT - ZY1

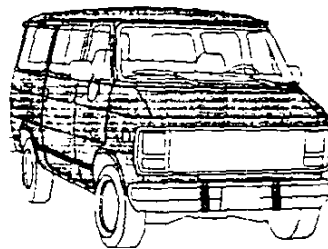

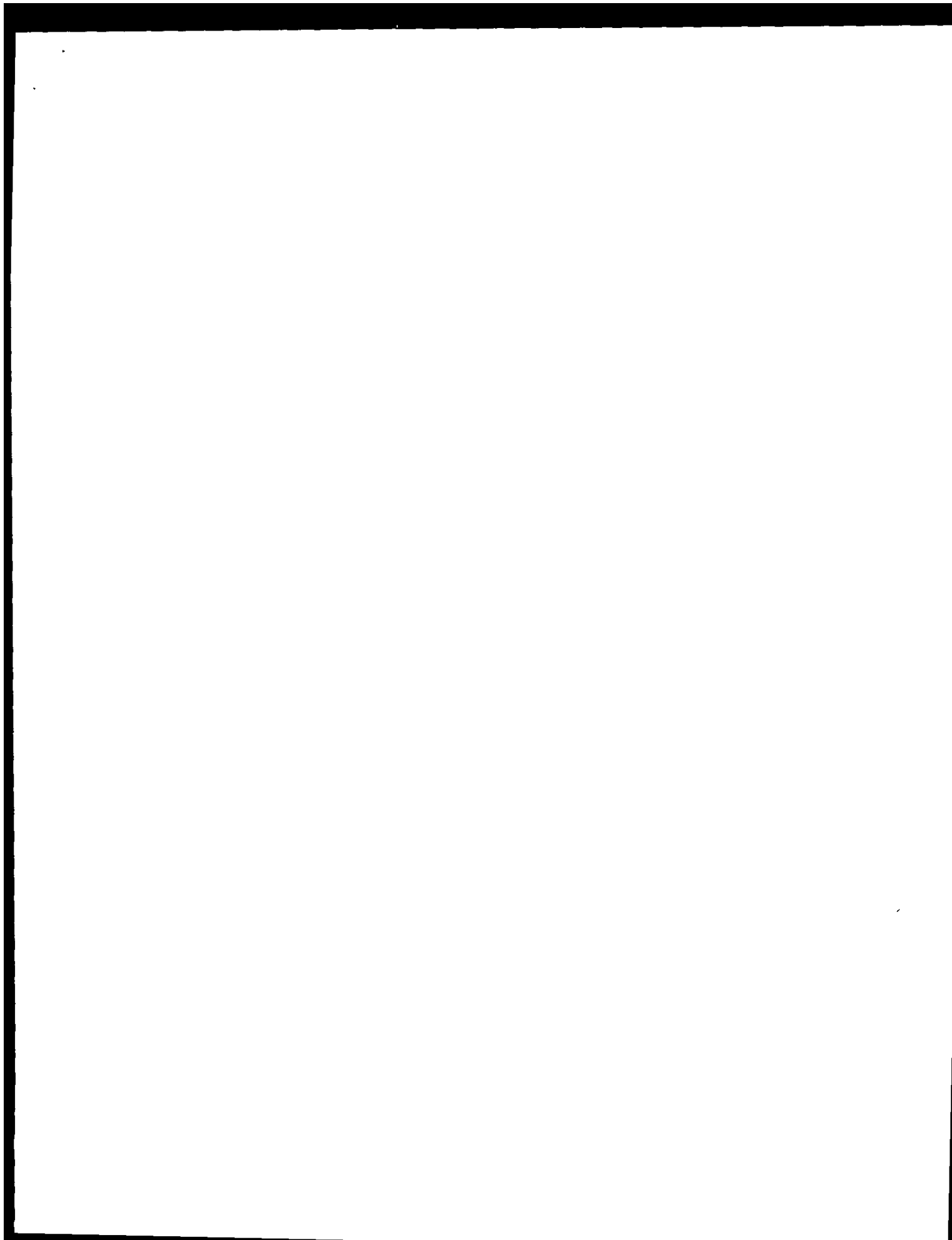

CHEVY VAN INTRODUCTION

CHEVY VAN

The Chevy Van is offered in three series: G10, G20 and G30.

Changes on the Chevy Van for 1994 include:

- 4.3L V6 Engine Enhancements
- 5.7L V8 Engine Enhancements
- 7.4L V8 Engine and Cooling Enhancements
- 6.5L V8 Diesel Engine with Natural Aspiration as an option
- Underhood/Underbody Corrosion Improvement
- Bottle Jack Replaced with Improved Operation Scissors Jack
- Driver's Facial Air Bag in Models below 8500 lbs. GVWR
- Electronic Engine Fuel Shut-Off System ensures vehicle top speed does not exceed Tire Speed Rating on G20 Models and G30 Models with Optional Diesel Engine
- Center High-Mounted Stop Lamp to meet FMVSS 108
- Enhanced Air Cleaner with Gasoline Engines
- Four New Exterior Colors
- Improved Compressor with Optional Air Conditioning
- Improved Spark Plug Wires on V8 Engines
- Standardized Powertrain Control Module for Improved Drivability
- R134a Refrigerant replaces the current R12 for an environmentally safe air conditioner
- Side Door Guard Beams to comply with FMVSS 214
- Smoother Shifting 4L80-E Transmission with 5.7L V8 and 7.4L V8 Engines
- Starter Motor with 5.7L V8 and 7.4L V8 Engines

CHEVY VAN

MODEL SELECTION SUMMARY

Use the chart below to choose the model that fits your customer's needs. Note that the Maximum Payload is based on curb weight. Also, the Maximum Gross Trailer Weight is based on vehicles that are properly equipped. See your 1994 Chevrolet Truck Order Guide for details.

SERIES	MODEL NUMBER/ BODY CODE/ OPTION CODE	PASSENGER CAPACITY (STD./OPT.)	STANDARD ENGINE/ TRANS.	OPTIONAL ENGINE/ TRANS.	GVWR (LBS.)	GAWR (LBS.) FRONT/ REAR	MAXIMUM PAYLOAD (LBS.) BASED ON CURB WT.	MAX. GROSS TRAILER WT./ TONGUE LOAD (LBS.) PROPERLY EQUIPPED
G-SERIES CHEVY VAN								
G10 CHEVY VAN								
G10 SHORT WHEELBASE	CG11005/ ZW9	2	4.3L V6/A4	— 5.0L V8/A4	6000	3166/3166	2339	5000/600 5500/700
G10 REGULAR WHEELBASE	CG11305/ ZW9	2	4.3L V6/A4	— 5.0L V8/A4	6000	3166/3166	1749	5000/600 5500/700
G20 CHEVY VAN								
G20 SHORT WHEELBASE	CG21005/ ZW9	2	4.3L V6/A4	— 5.0L V8/A4	6600	3400/3406	2397	5000/600 6500/800
G20 REGULAR WHEELBASE	CG21305/ ZW9	1/2	4.3L V6/A4	— 5.0L V8/A4 5.7L V8/A4	6600	3400/3406	2377	5000/600 6500/800 7000/850
G20 REGULAR WHEELBASE	CG21305/ ZW9/C6O	1/2	5.7L V8/A4	— 6.5L V8/A4	6875	3570/3500	2525	7000/850 6000/750
G30 CHEVY VAN								
G30 REGULAR WHEELBASE	CG31305/ ZW9	1/2	4.3L V6/A4	—	7100	3400/4380	2519	4000/500
G30 REGULAR WHEELBASE	CG31305/ ZW9/C6C	1/2	5.7L V8/A4	—	7400	3400/4380	2785	4500/550
G30 REGULAR WHEELBASE HD	CG31305/ ZW9/C6P/ YHF	1/2	5.7L V8/A4	— 4.3L V6/A4 7.4L V8/A4 6.5L V8/A4	8600	3880/5360	2932	8000/950 6000/750 10000/1000 6000/750
G30 REGULAR WHEELBASE HD	CG31305/ ZW9/C6W/ YHF	1/2	5.7L V8/A4	— 7.4L V8/A4 6.5L V8/A4	9200	4000/5360	2288	8000/950 10000/1000 6000/750
G30 EXTENDED WHEELBASE	CG31605/ ZW9	1/2	5.7L V8/A4	—	8600	3880/5360	3536	8000/950
G30 EXTENDED WHEELBASE	CG31605/ ZW9	1/2	7.4L V8/A4	— 6.5L V8/A4	8600	4000/5360	2136	10000/1000 6000/750
G30 EXTENDED WHEELBASE HD	CG31605/ ZW9/C6W/ YHF	1/2	5.7L V8/A4	— 7.4L V8/A4 6.5L V8/A4	9200	4000/5360	3976	8000/950 10000/1000 6000/750

CHEVY VAN

POWERTRAINS

Chevrolet offers a variety of engines, transmissions and rear axle ratios for the Chevy Van. The following charts detail basic engine, transmission and axle specifications. See your 1994 Chevrolet Truck Order Guide for details.

ENGINES								
	4.3L V6	4.3L V6 HD	5.0L V8	5.7L V8	5.7L V8 HD	7.4L V8 HD	6.5L V8 DIESEL	6.5L V8 DIESEL HD
Order Code	LB4	LB4	L03	L05	L05	L19	L19	L57
Availability	Under 8501 lbs. GVW	Over 3500 lbs. GVW	G10/G20	G20 and G30 below 8600 lbs.	G30 8600 lbs. and above GVW	G30 8600 lbs. and above GVW	G30	G30 8600 lbs. and above GVW
SAE Net Horsepower @ rpm	155 @ 4000	155 @ 4000	170 @ 4000	200 @ 4000	190 @ 4000	230 @ 3600	155 @ 3600	160 @ 3400
SAE Net Torque lbs.-ft. @ rpm	230 @ 2000	230 @ 2400	265 @ 2400	310 @ 2400	300 @ 2400	385 @ 1600	275 @ 1700	290 @ 1700
Fuel System	EFI	EFI	EFI	EFI	EFI	EFI	Indirect Fuel Injection	Indirect Fuel Injection
Standard Battery Cold Cranking Amps @ 0 F	600	600	600	600	600	600	2 @ 600 each	2 @ 600 each
Standard Alternator Max. Cap. (Amps)	100	100	100	100	100	100	100	100

TRANSMISSIONS		
	ELECTRONIC AUTOMATIC 4-SPEED OVERDRIVE W/TORQUE CONVERTER CLUTCH (4L80-E) (M30)	ELECTRONICALLY-CONTROLLED AUTOMATIC 4-SPEED W/OD HEAVY DUTY (4L80-E) (MT1)
Availability	G10/G20 and G30 below 8600 lbs. GVW	G30 8600 lbs. GVW and above
Order Code	MX0	MX0
Application	LB4/L03/L05/L49	LB4 HD/L05 HD/L19/L57
Gear Ratios		
First	3.06	2.48
Second	1.63	1.48
Third	1.00	1.00
Fourth	0.70	0.75
Fifth	—	—
Reverse	2.29	2.08
Power Take-Off	No	No

REAR AXLES											
Availability	G10/G20		G30 Under 8600 lbs. GVW		G30 8600 lbs. GVW			G30 9200 lbs. GVW			
Make	GM		GM		GM			GM			
Capacity (lbs.)	3500 Semi-Floating		5700 Semi-Floating		5700 Full-Floating			6000 Full-Floating			
Pinion and Ring Gear Type	Hypoid		Hypoid		Hypoid			Hypoid			
Engine Availability*	LB4/L03 L05/L49	LB4/L03 L05/L49	L05	LB4	L19	L05/ L19/ L57	LB4/ L05/ L19/ L57	LB4	L19	L05/L19/ L57	L05/L19/ L57
Axle Ratio Code	GU6	GT4	GU5	GT4	GU6	GT4	GT5	HC4	GU6	GT4	GT5
Ratio	3.42	3.73	3.23	3.73	3.42	3.73	4.10	4.56	3.42	3.73	4.10
Pinion Teeth	12	11	13	11	12	11	10	9	12	11	10
Ring Gear Teeth	41	41	42	41	41	41	41	41	41	41	41
Ring Gear Diameter (in.)	8.5	8.5	9.5	9.5	10.5	10.5	10.5	10.5	10.5	10.5	10.5

*Note: Axle Ratio availability depends on model, powertrain and emissions selected. See your 1994 Chevrolet Truck Order Guide for specific details.
 * Engine applications are heavy duty (HD) at 8600 lbs. GVW or above.

CHEVY VAN

TRIM LEVELS

Chevrolet offers the Chevy Van in one trim level, "Standard." The following chart details major standard features. See your 1994 Chevrolet Truck Order Guide for more details.

CHASSIS EQUIPMENT		STANDARD (ZW9)
KEY: ■ = STANDARD, — = NOT INCLUDED		
BRAKES	Power-assisted, front disc, rear drum with four wheel anti-lock system. Includes brake/transmission shift interlock.	■
EXHAUST	Single.	■
FRAME	All-welded integral body-frame construction.	■
FUEL TANK	22 gal. (approx.) capacity located between frame rails behind rear axle; filler located left rear. 33 gal. (approx.) capacity standard on Extended wheelbase and optional on Regular wheelbase models; filler located left rear.	■
REAR AXLE	G10, G20 and G30 below 8600 lbs. GVW: hypoid, semi-floating, G30 at or above 8600 lbs. GVW: Hypoid, full-floating.	■
SHOCK ABSORBERS	Front and rear: 32mm G10, G20; 35mm G30.	■
STABILIZER BAR	Front: 1.06 inch.	■
STEERING	Integral Power	■
SUSPENSIONS, FRONT	Independent w/coil springs.	■
SUSPENSIONS, REAR	Semi-elliptic, two-stage multi-leaf.	■
EXTERIOR EQUIPMENT		
BUMPER	Front and rear painted silver. Front bumper guards.	■
DOORS	Driver and passenger front side, choice of 60/40 hinged side-loading doors (E24) or sliding side-loading door (YA2) and RH and LH rear load doors. Also includes side door guard beams for added protection and strength.	■
DOOR STOPS	Positive rear.	■
GLASS	Solar-Ray™ tinted.	■
GRILLE	Molded plastic and front lamp bezels painted light argent.	■
HEADLAMPS	Single halogen.	■
HORN	Dual note.	■
HUBCAPS	Bright metal with black trim.	■
LAMPS	Center high-mounted stop lamp.	■
MIRRORS	RH and LH stainless steel below-eye-line type with pivoting arm and adjustable heads. 6.5" x 9.0".	■
MOLDINGS	Black body-side "rub strips".	■
TIRES	Four steel-belted radials. Size: G10: P215/75R15 Blackwall Steel-Belted Radial Ply. G20 Gas: P225/75R15 Blackwall Steel-Belted Radial Ply. G20 Diesel: P235/75R15 Blackwall Steel-Belted Steel Radial Ply. G30 Below 8600 GVW: LT225/75R16D Highway Steel-Belted Radial Ply BW. G30 Above 8600 GVW: LT225/75R16E Highway Steel-Belted Radial Ply BW.	■ ■ ■ ■ ■
UNDERCOATING	On body rocker panels, step panels and wheel housings.	■
WHEELS	G10 and G20: five, 15.0" x 6.0" argent steel wheels and bright metal hubcaps w/black trim. G30: five, 16.0" x 6.5" argent steel wheels.	■ ■
INTERIOR EQUIPMENT		
ARMRESTS	LH padded front door.	■
CIGARETTE LIGHTER	With ashtray.	■
COAT HOOK	LH.	■
DOME LAMP	Two with front door-actuated switches.	■
DRIVER'S FACIAL AIR BAG	Located in steering wheel hub.	■
FLOOR COVERING	Embossed black rubber mat over entire floor area and front wheel housing.	■
GAGES	Including speedometer, odometer, fuel level, oil pressure, voltmeter, engine temperature, and trip odometer.	■
HEADLINER	Mystic-colored perforated hardboard headliner in driver's area	■
HEATER	Deluxe outside air heater and defogger.	■

CHEVY VAN

INTERIOR EQUIPMENT (CONT.)

KEY: ■ = STANDARD, — = NOT INCLUDED		STANDARD (ZWS)
MIRROR	10-inch rearview.	■
PARCEL TRAY	On top surface of instrument panel extension, includes beverage holder provisions.	■
RADIO	Electronically-tuned AM radio with two 4" x 6" front dash speakers, digital clock and fixed mast antenna.	■
SEAT, FRONT	Driver's high-back adjustable bucket seat.	■
SPARE TIRE/WHEEL	Full-size, mounted on RH rear interior side of rear floor when specified.	■
STEERING WHEEL	Black, vinyl four-spoke with driver's facial airbag.	■
STORAGE BOX	With latched door on front face of instrument panel extension.	■
STEP PADS	Safety, on front and rear side door step panels.	■
SUNSHADES	Cloth RH and LH padded, color-keyed.	■
TOOLS	Includes scissor-type jack and wheel wrench located at RH rear of vehicle.	■
WINDSHIELD WIPERS	Intermittent.	■

PREFERRED EQUIPMENT GROUPS

Preferred Equipment Groups (PEGs) are convenient option packages that can save your customers money. They would pay appreciably more by buying all the options in a Preferred Equipment Group as individual options. (Savings based on a comparison of MSRP of option packages versus MSRP of individual options purchased separately). See your 1994 Chevrolet Truck Order Guide and Vehicle Price Schedule for specific information and prices.

OPTIONS

These options can be ordered individually in addition to the Preferred Equipment Groups if not already included. See your 1994 Chevrolet Truck Order Guide for specific availability and restrictions. The Option Code is listed in **bold type**.

Air Conditioning (front only)	C60	Federal Emissions Override	NC7	Lighting, Auxiliary	
Air Conditioning (front and rear)	C69	Cal./N.Y. Emissions Override	NB8	(includes front/rear dome and	
Antenna, Power	U75	Engines:		reading lamps, underhood lamp	
Appearance Package,		4.3L EFI V6	LB4	and headlamp warning buzzer) ...	TR9
Deluxe Front (includes dark argent		4.3L EFI V6 HD	LB4	Mirrors, Exterior Below-Eye-Line.	
grille w/brght trim and oval		5.0L EFI V8	L03	Electric, Stainless Steel	
rectangular headlamps)	V22	5.7L EFI V8	L05	(mirror head: 6.5" x 9.0")	DG9
Axles, Rear		5.7L EFI V8 HD	L05	Holdings, Delete (Reqs. B3D)	B98
3.23	GU5	7.4L EFI V8	L19	Paint, Exterior:	
3.42	GU6	6.5L I/F V8 Diesel	L49	Solid	ZY1
3.73	GT4	6.5L I/F V8 Diesel HD	L57	Radio	
4.10	GT5	Alternative Fuel	KL5	Radio Delete	UL5
4.56	HC4	Floor Covering, Carpeting		ETR AM/FM Stereo Radio w/	
Axle, Rear Locking Differential	G80	(floor & wheel housings, front		Seek-Scan, Digital Clock, front	
Bumpers,		area only, incl. front rubber		speakers and wiring for	
Front and Rear Chrome	V37	floor mats)	B30	rear speakers	UM7
Cold Climate Package (incl.		Glass		ETR AM/FM Stereo Radio w/	
Engine Block Heater, antifreeze		Full Body (six windows)	A07	Seek-Scan, Digital Clock, Stereo	
protection to -32° F)	V10	RH Rear Body Side (fixed glass for		Cassette, Premium Front speakers &	
Convenience Package, Driver's		RH rear quarter panel)	A08	wiring for rear speakers	UM6
(includes Tilt-Wheel™ steering,		Rear Door Fixed	A12	ETR AM/FM Stereo Radio w/	
electronic speed control)	ZQ3	Rear Door Swing-out	A18	Seek-Scan, Cassette w/Search/	
Convenience Package, Operating		Fixed Package (includes fixed rear		Repeat, Graphic Equalizer and	
(includes power door locks and		door and side door glass)	ZW3	Digital Clock	UX1
power windows)	ZQ2	Swing-out Package (incl. swing-out		ETR AM/FM Stereo Radio w/	
Cooling System		rear door and side door glass)	ZX6	Seek-Scan, Compact Disc Player,	
Heavy Duty (included w/Z82 trailering,		GVWR (codes for information only):		Digital Clock, Premium front	
Requires LB4 or L05 engine w/G31305.		6000 lbs.	C5J	speakers & wiring for	
Also requires L05 engine w/G31605.		6600 lbs.	C5S	rear speakers	U1C
N/A w/L19, L49 or L57 engine)	V08	6875 lbs.	C6Q	Recreational Sales Package.	
Defogger, Rear Window	C49	7100 lbs.	C5Y	Vehicle Uplifter (For information	
Door Locking System, Power	AU3	7400 lbs.	C6C	purposes only. YF7 is available for	
Door: Sliding Door, Side	YA2	8600 lbs.	C6P	ordering through authorized C.Q.A.C.P.	
Emissions:		9200 lbs.	C6W	manufacturers only.)	YF7
Federal	FE9	Heater, Auxiliary Rear	C36	School Bus Chassis Equipment	
High Altitude	NA6	Keyless Entry System, Remote		(Reqs. C6W 9200# GVWR)	B3D
California	YF5	(remote door lock/unlock functions		Seat, Front Auxiliary	A57
New York State	NG1	with illuminated entry and		Seat, Not desired	YG4
		headlamp delay)	AX3		

CHEVY VAN

OPTIONS (CONT.)

Steering Wheel (Leather wrapped) **NP5**
 Tank, Fuel (33 gallon (approx.) capacity standard on G30 Ext. wheelbase) **NL7**

Tire, Spare, not desired **R6Z**
 Trailering Package (heavy-duty) (includes hitch & alarm, P.D. flasher & seven-wire harness) **ZB2**
 Trailering Package (light-duty) (includes deadweight hitch and 16-wire harness) **Z72**

Wheels (heavy-duty (includes matching spare)) **N67**
 Wheel Covers (bright metal, full cover) **P01**

TIRES

KEY: ALS = ALL-SEASON SBR = STEEL-BELTED RADIAL PLY BW = BLACKWALL WW = WHITEWALL WL = WHITE LETTERED HWY = HIGHWAY BL = BLACK LETTERED OOR = ON-OFF ROAD WOL = WHITE OUTLINE LETTERED

TIRE DESCRIPTION	FRONT	REAR	SPARE
P215/75R15 ALS SBR/BW	XCU	XCU	ZCU
P215/75R15 ALS SBR/WW	XCV	XCV	ZCV
P225/75R15 ALS SBR/BW	XET	YET	ZET
P225/75R15 ALS SBR/WW	XEU	YEU	ZEU
P225/75R15 ALS SBR/WL	XEV	YEV	ZEV
P235/75R15 ALS SBR/BW	XFL	YFL	ZFL
P235/75R15 ALS SBR/WS	XFM	YFM	ZFM
LT225/75R16D ALS SBR/BW	XHP	YHP	ZHP
LT225/75R16E ALS SBR/BW	XHF	YHF	ZHF

DIMENSIONS

SERIES	G10		G20		G30		
	CHEVY VAN SHORT WHEELBASE	CHEVY VAN REGULAR WHEELBASE	CHEVY VAN SHORT WHEELBASE	CHEVY VAN REGULAR WHEELBASE	CHEVY VAN REGULAR WHEELBASE	CHEVY VAN REGULAR WHEELBASE HEAVY-DUTY	CHEVY VAN EXTENDED WHEELBASE
MODEL NUMBER	CG11005/ZW9	CG11305/ZW9	CG21005/ZW9	CG21305/ZW9	CG31305/ZW9	CG31305/ZW9/C6P/C6W	CG31605/ZW9/C6P/C6W

EXTERIOR DIMENSIONS:

BODY							
Wheelbase (in.)	110.0	125.0	110.0	125.0	125.0	125.0	146.0
Overall Length (in.)	180.1	204.1	180.1	204.1	204.1	204.1	225.1
Overall Height (in.)							
Nominal Pass-Over (in.)	30.0	33.9	30.9	30.9/30.5	32.3	32.3	32.3
Maximum Width (in.)	79.5	73.5	79.5	79.5	79.5	79.5	79.5
Bumper to Axle							
Front (in.)	29.6	33.6	29.6	29.6	29.6	29.6	29.6
Rear (in.)	38.5	47.5	38.5	47.5	47.5	47.5	47.5
Ground to Top of Rear Load Floor (in.)	25.0	24.7	25.9	25.5	27.3	27.3	30.1
Ground Clearance							
Front/Rear (in.)							
Gas	6.9/7.8	6.8/7.6	8.3/9.1	8.1/8.8	10.2/8.0	10.8/8.5	9.1/9.6
Diesel	—	—	—	3.4/9.4	—	9.4/8.5	9.1/9.6
Side Load Door Sliding (E24)							
Opening Height (in.)	49.3	49.3	49.3	49.3	49.3	49.3	—
Opening Width (in.)	44.2	44.2	44.2	44.2	44.2	44.2	—
Side Load Door Swing-Out (YA2)							
Opening Height (in.)	48.5	48.5	48.5	48.5	48.5	48.5	48.5
Opening Width (in.)							
—Both Doors Open	46.7	46.7	46.7	46.7	46.7	46.7	46.7
—Large Door Only	30.3	30.3	30.3	30.3	30.3	30.3	30.3
—Small Door Only	19.0	19.0	19.0	19.0	19.0	19.0	19.0
Rear Load Door							
Opening Height (in.)	48.9	48.9	48.9	48.9	48.9	48.9	48.9
Opening Width (in.)	54.4	54.4	54.4	54.4	54.4	54.4	54.4
Turning Diameter							
Curb-to-Curb (in.)	41.3	43.9	41.3	46.0	48.5	48.5	54.0
SIGN PANEL AREA (In.)	51.25 x 94	51.25 x 113.5	51.25 x 94	51.25 x 118.5	51.25 x 113.5	51.25 x 118.5	51.25 x 139.5

CHEVY VAN

DIMENSIONS (CONT.)

SERIES	G10		G20			G30	
MODEL	CHEVY VAN SHORT WHEELBASE	CHEVY VAN REGULAR WHEELBASE	CHEVY VAN SHORT WHEELBASE	CHEVY VAN REGULAR WHEELBASE	CHEVY VAN REGULAR WHEELBASE	CHEVY VAN REGULAR WHEELBASE HEAVY-DUTY	CHEVY VAN EXTENDED WHEELBASE
MODEL NUMBER	CG11005/ZW9	CG11305/ZW9	CG21005/ZW9	CG21305/ZW9	CG31305/ZW9	CG31305/ZW9/ C6P/C6W	CG31605/ZW9/ C6P/C6W
INTERIOR DIMENSIONS							
Headroom Front (in.)	40.8	40.8	40.8	40.8	40.8	40.8	40.8
Legroom Front (in.)	39.5	39.5	39.5	39.5	39.5	39.5	39.5
Shoulder Room Front (in.)	68.8	68.8	68.8	68.8	68.8	68.8	66.8
Hip Room Front (in.)	69.7	69.7	69.7	69.7	69.7	69.7	69.7
Load Floor Length (in.) w/Front Seats	102.5	126.5	102.5	126.5	126.5	126.5	147.5
Inside Width at Beltline (in.)	70.8	70.8	70.8	70.8	70.8	70.8	70.8
Inside Width between Wheelhouses (in.)	53.5	53.5	53.5	53.5	53.5	53.5	53.5
Interior Height (in.)	53.7	53.8	53.7	53.8	53.8	53.8	53.8
Cargo Volume w/Front Seat (cu. ft.)	207.0	260.0	207.0	260.0	260.0	260.0	306.0

SPORTVAN INTRODUCTION

SPORTVAN

The Sportvan is offered in two series: G20 and G30. Sportvan also has two trim levels available: "Standard" and "Beauville."

Changes on the Sportvan for 1994 include:

- 4.3L V6 Engine Enhancements
 - 5.7L V8 Engine Enhancements
 - 7.4L V8 Engine and Cooling Enhancements
 - 6.5L V8 Diesel Engine with Natural Aspiration as an option
 - Underhood/Underbody Corrosion Improvement
 - *Bottle Jack Replaced with Improved Operation Scissors Jack*
 - Driver's Facial Air Bag in models below 8500 lbs. GVWR
 - Electronic Engine Fuel Shut-Off System ensures vehicle top speed does not exceed Tire Speed Rating on G20 Models and G30 Models with Optional Diesel Engine
 - Center High-Mounted Stop Lamp to meet FMVSS 108
 - Enhanced Air Cleaner with Gasoline Engines
 - Four New Exterior Colors
 - Improved Compressor with Optional Air Conditioning
 - Improved Spark Plug Wires on V8 Engines
 - Standardized Powertrain Control Module for improved drivability
 - R134a Refrigerant replaces the current R12 for an environmentally safe air conditioner
 - Side Door Guard Beams to comply with FMVSS 214
 - Smoother Shifting 4L80-E Transmission with 5.7L V8 and 7.4L V8 Engines
 - Starter Motor with 5.7L V8 and 7.4L V8 Engines
 - Improved Drivability of Automatic Transmissions
 - Scotchgard® Protected Carpeting
-

SPORTVAN

MODEL SELECTION SUMMARY

Use the chart below to choose the model that fits your customer's needs. Note that the Maximum Payload is based on curb weight. Also, the Maximum Gross Trailer Weight is based on vehicles that are properly equipped. See your 1994 Chevrolet Truck Order Guide for details.

SERIES	MODEL NUMBER/ BODY CODE/ OPTION CODE	PASSENGER CAPACITY (STD./OPT.)	STANDARD ENGINE/ TRANS.	OPTIONAL ENGINE/ TRANS.	GVWR (LBS.)	GAWR (LBS.) FRONT/ REAR	MAXIMUM PAYLOAD (LBS.) BASED ON CURB WT.	MAX. GROSS TRAILER WT./ TONGUE LOAD (LBS.) PROPERLY EQUIPPED
G-SERIES SPORTVAN								
G20 SPORTVAN								
G20 REGULAR WHEELBASE	CG21306/ ZW9 N/A FL Tires	5.5	4.3L V6/A4	— 5.0L V8/A4 5.7L V8/A4	6600	3400/3406	1993	5000/600 6500/800 7000/850
G20 REGULAR WHEELBASE	CG21306/ ZW9	3.5	5.7L V8/A4	— 6.5L V8/A4	6875	3600/3500	2142	7000/850 6000/750
G30 SPORTVAN								
G30 REGULAR WHEELBASE	CG31306/ ZW9	12/8	5.7L V8/A4	—	7400	3400/4380	2202	4500/550
G30 REGULAR WHEELBASE HD	CG31306/ ZW9/C6P Reqs. YHF Tires 1	12/3	5.7L V8/A4	— 7.4L V8/A4 6.5L V8/A4	8600	3880/5360	3522	8000/950 10000/1000 6000/750
G30 REGULAR WHEELBASE HD	CG31306/ ZW9/C6W Reqs. YHF Tires 1	12/8	5.7L V8/A4	— 7.4L V8/A4 6.5L V8/A4	9200	4000/5360	3951	8000/950 10000/1000 6000/750
G30 EXTENDED WHEELBASE	CG31606/ ZW9/C6P Reqs. YHF Tires 1	12/15	5.7L V8/A4	— 7.4L V8/A4 6.5L V8/A4	8600	3880/5360	3035	8000/950 10000/1000 6000/750
G30 EXTENDED WHEELBASE	CG31606/ ZW9/C6W Reqs. YHF Tires 1	12/15	5.7L V8/A4	— 7.4L V8/A4 6.5L V8/A4	9200	4000/5360	3476	8000/950 10000/1000 6000/750

POWERTRAINS

Chevrolet offers a variety of engines, transmissions and rear axle ratios for the Sportvans. The following charts detail basic engine, transmission and axle specifications. See your 1994 Chevrolet Truck Order Guide for details.

	ENGINES							
	4.3L V6	5.0L V8	5.7L V8	5.7L V8 HD	7.4L V8 HD	6.5L V8 DIESEL	6.5L V8 DIESEL HD	
Order Code	L84	L03	L05	L05	L19	L49	L57	
Availability	G20	G20	G20 and G30 below 8600 lbs. GVW	G30 8600 lbs. and above GVW	G30 8600 lbs. and above GVW	G20	G30 8600 lbs. and above GVW	
SAE Net Horsepower @ rpm	155 @ 4000	170 @ 4000	200 @ 4000	190 @ 4000	230 @ 3600	155 @ 3600	160 @ 3400	
SAE Net Torque lbs.-ft. @ rpm	230 @ 2000	285 @ 2400	310 @ 2400	300 @ 2400	385 @ 1600	275 @ 1700	290 @ 1700	
Fuel System	EFI	EFI	EFI	EFI	EFI	Indirect Fuel Injection	Indirect Fuel Injection	
Standard Battery Cold Cranking Amps @ 0 F	600	600	600	600	600	2 @ 600 each	2 @ 600 each	
Standard Alternator Maximum Capacity (Amps)	100	100	100	100	100	100	100	

SPORTVAN

TRANSMISSIONS

	ELECTRONICALLY CONTROLLED AUTOMATIC 4-SPEED W/OD AND TORQUE CONVERTER CLUTCH (4L80-E) (M30)	ELECTRONICALLY CONTROLLED AUTOMATIC 4-SPEED W/OD HD (4L80-E) (MT1)
Order Code	MX0	MX0
Availability	G20 and G30 below 8600 lbs. GVW	G30 8600 lbs. GVW and above
Engine Availability	LB4/L03/L05/L49	L19 HD/L05 HD L57
Gear Ratios		
First	3.06	2.48
Second	1.63	1.48
Third	1.00	1.00
Fourth	0.70	0.75
Fifth	—	—
Reverse	2.29	2.08
Power Take-Off	No	No

REAR AXLES

Availability	G20		G30 under 8600 lbs. GVW	G30 8600 lbs. GVW			G30 9200 lbs. GVW		
Make	GM		GM	GM			GM		
Capacity (lbs.)	3500		5700	5700 Full-Floating			8000 Full-Floating		
Pinion and Ring Gear Type	Hypoid		Hypoid	Hypoid			Hypoid		
Engine Availability *	LB4/L03/L05/L49	LB4/L03/L05/L49	L05	L19	L05/L19/L57	L05/L19/L57	L19	L19	L05/L19/L57
Axle Ratio Code	GU6	GT4	GU5	GU6	GT4	GT5	GU6	GT4	GT5
Ratio	3.42	3.73	3.23	3.42	3.73	4.10	3.42	3.73	4.10
Pinion Teeth	12	11	13	12	11	10	12	11	10
Ring Gear Teeth	41	41	42	41	41	41	41	41	41
Ring Gear Diameter (in.)	8.5	8.5	9.5	10.5	10.5	10.5	10.5	10.5	10.5

*Note: Axle Ratio depends on model, powertrain and emissions selected. See your 1994 Chevrolet Truck Order Guide.
 * Engine applications are heavy-duty (HD) at 8600 lbs. GVW or above.

TRIM LEVELS

Chevrolet offers the Sportvan in two trim levels: "Standard" and "Beauville." The following chart details major standard features. See your 1994 Chevrolet Truck Order Guide for details.

CHASSIS EQUIPMENT

KEY: ■ = STANDARD, — = NOT INCLUDED		STANDARD (ZV9)	BEAUVILLE (E94)
BRAKES	Power-assisted, front disc, rear drum; includes four-wheel anti-lock system.	■	■
EXHAUST	Single.	■	■
FRAME	All-welded integral body-frame construction.	■	■
FUEL TANK	33 gal. (approx.) capacity; located between frame rails behind rear axle.	■	■
REAR AXLE	G20 and G30 below 8600 lbs. GVW: hypoid, semi-floating; G30 above 8600 lbs. GVW: hypoid, full-floating.	■	■
SHOCK ABSORBERS	Front and rear: 32 mm G20; 35 mm on G30.	■	■
STABILIZER BAR	Front 1.06 inch.	■	■
STEERING	Integral power.	■	■
SUSPENSION, FRONT	Independent w/ coil springs.	■	■
SUSPENSION, REAR	Semi-elliptic, two-stage multi-leaf.	■	■

SPORTVAN

EXTERIOR EQUIPMENT			STANDARD (ZWS)	BEAUVILLE (E94)
Key: ■ = standard, — = not included				
BUMPER	Front and rear chromed with front bumper guards.		■	■
DOORS	Driver and passenger front side, choice of 60/40 hinged side-loading doors (E24) or sliding side-loading door (YA2), and RH and LH rear-load doors. Also includes side door guard beams for added protection and strength.		■	■
DOOR STOPS	Positive rear.		■	■
DOOR TRIM PANELS	Color-keyed cloth on front and rear doors and rear quarter panels. No trim panels on rear doors.		■	■
GLASS (FRONT TO REAR)	Includes windshield, front doors, LH swing-out quarter glass, RH and LH rear quarter glass, and LH and RH rear door swing-out glass.		■	■
GRILLE	Light argent molded with chrome accent. Chrome.		■	—
HEADLAMPS	Single halogen. Dual rectangular halogen.		■	—
HORN	Dual low- and high-note.		■	■
LAMPS	Center high mounted stop lamp.		■	■
MIRRORS	RH and LH stainless steel below-eye-line type with pivoting arm and adjustable heads. Head size 6.5" x 9.0".		■	■
MOLDINGS	Black body-side. Black body-side with bright strip and bright wheel opening moldings.		■	—
TIRES	Four steel-belted radials. Size: G20 Gas: P225/75R15 blackwall steel-belted radial ply. G20 Diesel: P235/75R15 blackwall steel-belted radial ply. G30 Below 8600 GVW: LT225/75R16D blackwall steel-belted radial ply. G30 Above 8600 GVW: LT225/75R16E blackwall steel-belted radial ply.		■	■
UNDERCOATINGS	On body rocker panels, step panels and wheelhouseings.		■	■
WHEELS	G20: four, 15.0" x 6.0" argent steel wheels with bright metal hubcaps with black trim. G30: four, 16.0" x 6.5" argent steel wheels.		■	■
WINDOWS	Solar-Ray ¹ tinted glass.		■	■

INTERIOR EQUIPMENT			STANDARD (ZWS)	BEAUVILLE (E94)
ARMRESTS	Padded RH and LH front door and rear seat.		■	■
ASHTRAY	Instrument panel and front bucket seat backs.		■	■
BEVERAGE HOLDERS	Parcel tray and top surface of instrument panel extension.		■	■
CIGARETTE LIGHTER	Includes ashtray lamp.		■	■
COAT HOOKS	LH. LH, RH and rear.		■	—
DOME LAMP	Front and rear with front door-actuated switches.		■	■
DRIVER'S FACIAL AIR BAG	Located in steering wheel hub.		■	■
FRONT READING LAMPS			—	■
FLOOR COVERING	Embossed black rubber mats over entire floor area and front wheelhouseings. Color-keyed carpeting with Scotchgard [™] over entire floor area with color-keyed rubber front and rear floor mats.		■	—
GAGES	Including speedometer, odometer, fuel level, oil pressure, voltmeter, engine temperature and trip odometer.		■	■
HEADLINER	Full-length with garnish moldings. Full-length cloth with garnish moldings.		■	—
INSTRUMENT PANEL	Brushed finish applique around cluster area.		—	■
INSULATION	Instrument panel, front floor panel, engine cover front extension and inside engine cover. Instrument panel, front floor panel, engine cover front extension and inside engine cover. Also, above headliner and on wheelhouseings.		■	—
MIRROR	10-inch rearview.		■	■

SPORTVAN

OPTIONS (CONT.)

Trailering Package Light-Duty
(includes deadweight hitch,
HD flasher and
five-wire harness) **Z72**

Trailering Package Heavy-Duty
(includes deadweight hitch, HD flasher
and seven-wire harness) **Z82**

Transmissions:
Electronic 4-speed Automatic with
Overdrive, Torque Converter Clutch and
Brake/Trans. Shift Interlock **MX0 (M30)**
Electronically-controlled 4-speed
Automatic with Overdrive, heavy-
duty with Brake/Transmission
Shift Interlock **MX0 (MT1)**

Wheels, Aluminum
(G21306 only) **N90**

Wheels, Rally
(includes matching spare wheel) **N67**

Wheel Covers
(bright metal, full cover) **P01**

TIRES

KEY: ALS = ALL-SEASON SBR = STEEL-BELTED RADIAL PLY BW = BLACKWALL WW = WHITEWALL WL = WHITE LETTERED
HWY = HIGHWAY BL = BLACK LETTERED OOR = ON-OFF ROAD WOL = WHITE OUTLINE LETTERED

TIRE DESCRIPTION	FRONT	REAR	SPARE
P225/75R15 ALS/SBR/WW	XEU	YEU	ZEU
P225/75R15 ALS/SBR/BW	XET	YET	ZET
P225/75R15 ALS/SBR/WL	XEV	YEV	ZEV
P235/75R15 ALS/SBR/BW	XFL	YFL	ZFL
P225/75R16D ALS/SBR/EW	XHF	YHF	ZHF
P225/75R16E ALS/SBR/BW	XHP	YHP	ZHP

DIMENSIONS

SERIES	G20		G30	
	SPORTVAN/ BEAUVILLE REGULAR WHEELBASE	SPORTVAN/ BEAUVILLE REGULAR WHEELBASE	SPORTVAN/ BEAUVILLE- REGULAR WHEELBASE HEAVY-DUTY	SPORTVAN/ BEAUVILLE EXTENDED WHEELBASE
MODEL NUMBER	CG21306/ ZW9-E94	CG31306/ ZW9-E94	CG31306/ ZW9-E94/ C6P-C6W	CG31606/ ZW9-E94 C6P-C6W

EXTERIOR DIMENSIONS

BODY				
Wheelbase (in.)	125.0	125.0	125.0	146.0
Overall Length (in.)	204.1	204.1	204.5	225.1
Overall Height (in.) Nominal	79.5	81.8	81.9	82.3
Maximum Width (in.)	79.5	79.5	79.5	79.5
Bumper to Axle				
Front (in.)	29.6	29.6	29.6	29.6
Rear (in.)	47.5	47.5	47.5	47.5
Ground to Top of Rear Load Floor (in.)	24.9	27.0	27.0	29.6
Ground Clearance				
Front (in.)	7.8	9.6	10.0	8.9
Rear (in.)	8.6	7.3	8.5	9.6
Side Load Door Sliding (E24)				
Opening Height (in.)	49.3	49.3	49.3	—
Opening Width (in.)	44.2	44.2	44.2	—
Side Load Door Swing-Out (YA2)				
Opening Height (in.)	48.5	48.5	48.5	48.5
Opening Width (in.)				
— Both Doors Open	46.7	46.7	46.7	46.7
— Large Door Only	30.3	30.3	30.3	30.3
— Small Door Only	19.2	19.2	19.2	19.2
Rear Load Door				
Opening Height (in.)	48.9	48.9	48.9	48.9
Opening Width (in.)	54.4	54.4	54.4	54.4
Turning Diameter				
Curb-to-Curb (ft.)	46.0	48.5	48.5	54.0
SIGN PANEL AREA (in.)				
Shaded Area	29.0 x 121.5	29.0 x 121.5	29.0 x 121.5	29.0 x 142.5

SPORTVAN

DIMENSIONS

SERIES	G20		G30	
MODEL	SPORTVAN/ BEAUVILLE REGULAR WHEELBASE	SPORTVAN/ BEAUVILLE REGULAR WHEELBASE	SPORTVAN/ BEAUVILLE- REGULAR WHEELBASE HEAVY-DUTY	SPORTVAN/ BEAUVILLE EXTENDED WHEELBASE
MODEL NUMBER	CG21306/ ZW9-E94	CG31306/ ZW9-E94	CG31306/ ZW9-E94/ C6P-C6W	CG31606/ ZW9-E94 C6P-C6W

INTERIOR DIMENSIONS

Headroom				
Front/Middle 1	40.8/40.9	40.8/40.9	40.8/40.9	40.8/40.9
Middle 2/Rear (in.)	40.7/—	40.7/40.1	40.7/40.1	40.7/40.1
Legroom				
Front/Middle 1	39.5/37.2	39.5/37.2	39.5/37.2	39.5/37.2
Middle 2/Rear (in.)	39.5/—	39.5/40.5	39.5/40.5	39.5/40.5
Shoulder Room				
Front/Middle 1	68.8/63.5	68.8/63.5	68.8/63.5	68.8/63.5
Middle 2/Rear (in.)	63.5/—	63.5/71.0	63.5/71.0	63.5/71.0
Hip Room				
Front/Middle 1	69.7/51.5	69.7/51.5	69.7/51.5	69.7/51.5
Middle 2/Rear (in.)	51.5/—	51.5/63.0	51.5/63.0	51.5/63.0
Load Floor Length (in.)				
w/Front Seats	126.5	126.5	126.5	147.5
w/Front, Middle Seat 1	91.7	91.7	91.7	112.7
w/Front, Middle 1, Middle 2	58.7	58.7	58.7	81.1
Inside Width at Beltline (in.)	71.0	71.0	71.0	71.0
Inside Width between Wheelhouses (in.)	53.5	53.5	53.5	53.5
Interior Height (in.)	53.0	53.0	53.0	53.0
Cargo Volume				
w/Driver's Seat (cu. ft.)	260.0	260.0	260.0	306.0

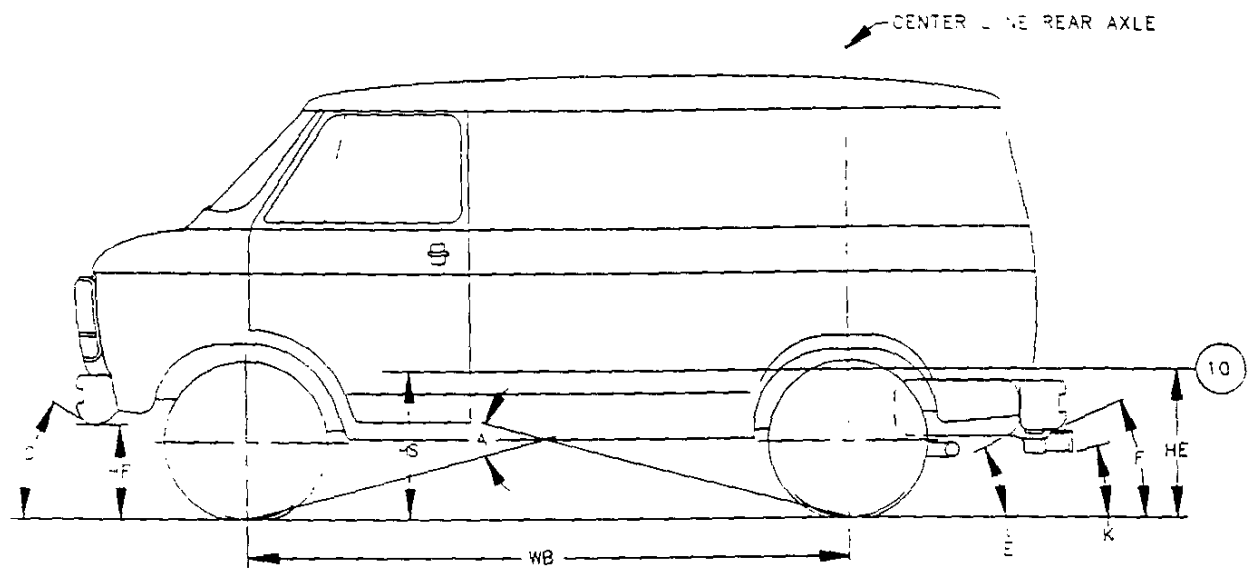

HEIGHTS AND LENGTHS

- HF Bottom of bumper to ground
- HE Top of rear floor load height
- HS Floor height at H-point

ANGLE(S)

- A Ramp breakover

ANGLE(S) (APPROACH)

- C Front bumper

ANGLE(S) (DEPARTURE)

- E Fuel tank
- F Rear bumper
- K Platform hitch

G Models

G11005		110.0" Wheelbase					Heights at Base Model Curb Weight			Heights and Angular Dimension are shown at Maximum GAWR Front and Rear						
GVW/Tire	Base Model Curb Weight			GAWR		HF	HE	HS	HF	HE	HS	A	C	E	F	K
	Frt	Rr	Ttl	Frt	Rr											
6000 P215/75R15	2222	1750	3972	3166	3166	14.6	25.1	23.8	12.5	22.2	21.4	23	28	26	20	12

G11305		125.0" Wheelbase					Heights at Base Model Curb Weight			Heights and Angular Dimension are shown at Maximum GAWR Front and Rear						
GVW/Tire	Base Model Curb Weight			GAWR		HF	HE	HS	HF	HE	HS	A	C	E	F	K
	Frt	Rr	Ttl	Frt	Rr											
6000 P215/75R15	2284	1834	4118	3166	3166	14.5	24.9	23.6	12.6	22.2	21.4	16	28	18	16	10

G21005		110.0" Wheelbase					Heights at Base Model Curb Weight			Heights and Angular Dimension are shown at Maximum GAWR Front and Rear							
GVW/Tire	Base Model Curb Weight			GAWR		HF	HE	HS	HF	HE	HS	A	C	E	F	G	K
	Frt	Rr	Ttl	Frt	Rr												
6600 P225/75R15	2220	1724	3944	3400	3406	15.4	28.1	25.4	12.6	25.2	22.6	24	28	36	25	31	17

G21305		125.0" Wheelbase					Heights at Base Model Curb Weight			Heights and Angular Dimension are shown at Maximum GAWR Front and Rear						
GVW/Tire	Base Model Curb Weight			GAWR		HF	HE	HS	HF	HE	HS	A	C	E	F	K
	Frt	Rr	Ttl	Frt	Rr											
6600 P225/75R15	2282	1798	4080	3400	3406	15.3	28.1	25.0	12.7	25.3	22.5	19	28	24	20	14
6875 P235/75R15	2472	1830	4302	3600	3508	14.9	28.2	24.6	12.3	25.4	22.3	19	27	24	20	14

G21306		125.0" Wheelbase					Heights at Base Model Curb Weight			Heights and Angular Dimension are shown at Maximum GAWR Front and Rear						
GVW/Tire	Base Model Curb Weight			GAWR		HF	HE	HS	HF	HE	HS	A	C	E	F	K
	Frt	Rr	Ttl	Frt	Rr											
6600 P225/75R15	2436	2214	4650	3400	3406	15.0	27.2	24.7	12.7	25.3	22.5	19	28	24	20	14

G31303		125.0" Wheelbase					Heights at Base Model Curb Weight			Heights and Angular Dimension are shown at Maximum GAWR Front and Rear						
GVW/Tire	Base Model Curb Weight			GAWR		HF	HE	HS	HF	HE	HS	A	C	E	F	K
	Frt	Rr	Ttl	Frt	Rr											
9200 LT225/75R16	2542	1604	4146	4000	5360	16.3	31.8	27.1	13.9	27.5	24.0	25	31	28	N/A	N/A
10000 LT225/75R16	2592	1844	4436	3900	7200	16.5	32.9	27.5	14.8	26.5	24.3	25	33	26	N/A	N/A

G Models (continued)

G31305		125.0" Wheelbase				Heights at Base Model Curb Weight			Heights and Angular Dimension are shown at Maximum GAWR Front and Rear							
GVW/Tire	Base Model Curb Weight			GAWR		HF	HE	HS	HF	HE	HS	A	C	E	F	K
	Frt	Rr	Ttl	Frt	Rr											
7100 LT225/75R16	2528	2050	4578	3400	4380	16.8	29.2	26.6	15.1	25.7	24.2	23	34	25	14	14
7400 LT225/75R16	2510	2046	4556	3400	4380	16.8	29.2	26.0	15.1	25.7	24.2	23	34	25	14	14
8600 LT225/75R16	2504	2034	4538	3880	5360	17.4	29.2	27.0	14.5	25.0	23.6	22	32	24	14	13
9200 LT225/75R16	2548	2158	4706	4000	5360	16.7	30.5	26.9	13.4	27.4	23.7	23	30	28	16	

G31306		125.0" Wheelbase				Heights at Base Model Curb Weight			Heights and Angular Dimension are shown at Maximum GAWR Front and Rear							
GVW/Tire	Base Model Curb Weight			GAWR		HF	HE	HS	HF	HE	HS	A	C	E	F	K
	Frt	Rr	Ttl	Frt	Rr											
7400 LT225/75R16	2688	2452	5140	3400	4380	17.0	28.5	26.5	15.6	25.6	24.6	17	35	25	14	14
8600 LT225/75R16	2684	2410	5094	3880	5360	17.1	28.7	26.6	14.5	25.0	23.6	22	32	24	14	13
9200 LT225/75R16	2688	2522	5210	4000	5360	16.9	30.5	27.0	13.9	27.8	24.1	24	31	29	16	N/A

G31332		125.0" Wheelbase				Heights at Base Model Curb Weight			Heights and Angular Dimension are shown at Maximum GAWR Front and Rear							
GVW/Tire	Base Model Curb Weight			GAWR		HF	HE	HS	HF	HE	HS	A	C	E	F	K
	Frt	Rr	Ttl	Frt	Rr											
8900 LT225/75R16	2560	1814	4374	3880	6500	16.8	32.3	27.7	14.4	26.1	24.0	23	32	26	N/A	N/A
10200 LT225/75R16	2580	1730	4310	3900	7200	16.7	32.6	27.8	14.3	26.3	24.1	23	32	26	N/A	N/A

G31603		146.0" Wheelbase				Heights at Base Model Curb Weight			Heights and Angular Dimension are shown at Maximum GAWR Front and Rear							
GVW/Tire	Base Model Curb Weight			GAWR		HF	HE	HS	HF	HE	HS	A	C	E	F	K
	Frt	Rr	Ttl	Frt	Rr											
9200 LT225/75R16	2626	1690	4316	4000	5360	16.6	32.5	27.2	14.5	27.1	24.2	11	32	27	22	N/A
10000 LT225/75R16	2848	1914	4762	4000	7200	16.2	32.1	26.8	14.9	24.4	23.7	11	33	22	18	N/A
10500 LT225/75R16	2866	1914	4780	4000	7200	16.2	32.1	26.8	14.9	24.4	23.7	11	33	22	19	N/A

G31605		146.0" Wheelbase				Heights at Base Model Curb Weight			Heights and Angular Dimension are shown at Maximum GAWR Front and Rear							
GVW/Tire	Base Model Curb Weight			GAWR		HF	HE	HS	HF	HE	HS	A	C	E	F	K
	Frt	Rr	Ttl	Frt	Rr											
8600 LT225/75R16	2644	2238	4882	3880	5360	16.8	30.7	27.0	14.3	25.5	24.0	19	32	27	22	N/A
9200 LT225/75R16	2638	2340	4978	4000	5360	16.5	30.1	26.7	13.6	25.2	23.4	18	30	26	22	N/A

G Models (continued)

G31606 146.0" Wheelbase						Heights at Base Model Curb Weight			Heights and Angular Dimension are shown at Maximum GAWR Front and Rear							
GVW/Tire	Base Model Curb Weight			GAWR		HF	HE	HS	HF	HE	HS	A	C	E	F	K
	Frt	Rr	Td	Frt	Rr											
8600 LT225/75R16	2860	2780	5540	3880	5360	16.4	29.9	26.5	14.3	26.5	24.0	19	32	27	22	N/A
9200 LT225/75R16	2858	3000	5858	4000	5360	16.5	29.3	26.5	14.5	26.5	24.2	19	32	27	22	N/A

G31632 146.0" Wheelbase						Heights at Base Model Curb Weight			Heights and Angular Dimension are shown at Maximum GAWR Front and Rear							
GVW/Tire	Base Model Curb Weight			GAWR		HF	HE	HS	HF	HE	HS	A	C	E	F	K
	Frt	Rr	Td	Frt	Rr											
10500 LT225/75R16	2672	1894	4566	4000	7200	16.7	32.2	27.4	14.2	26.3	23.8	19	32	26	32	N/A

