

94 S-Blazer

ORDERING INFORMATION

Focus Vehicle—Four-Door S-Blazer 4x4 Tahoe. This version of S-Blazer appeals to a large segment of buyers looking for a tough, versatile sport utility vehicle with mid-level refinements. When equipped with PEG 3 (DAA3), this model represents an excellent opportunity for high volume S-Blazer sales at your dealership.

Feature Vehicle—Four-Door S-Blazer 4x4 Tahoe LT (detailed on the following sheet).

■ Performance

■ **4.3 Liter EFI V6 Engine with Balance Shaft**—enhanced engine smoothness, provides 165 hp/235 lb.-ft. of torque and tows up to 4,000 lbs. (up to 5,250 lbs. with properly equipped 4x4, including optional engine) ■ **Five-Speed Manual Transmission**—overdrive gear lowers engine speed when cruising, contributing to higher fuel efficiency, reduced engine wear ■ **Insta-Trac System**—shifts from 2WD to 4WD High and back at any speed

■ Options

■ **Choice of Engines**—enhanced 4.3 Liter V6 engine with Central Port Injection and balance shaft provides more power than standard 4.3 Liter EFI V6 throughout operating range, generates 200 hp/260 lb.-ft. of torque ■ **Manual and Automatic Transmissions**—optional four-speed electronically controlled automatic transmission offers a smooth shifting alternative (automatic only available with 4.3 Liter CPI V6) ■ **Sound Systems**—available systems to fit a range of budgets and needs include Graphic Equalizer, Compact Disc, extended range front and rear speakers ■ **Light and Heavy Trailering Packages**—extra capacity cooling for engine and transmission, wiring harness, heavy duty flasher, towing axle ratio, hitches (contents vary with package)

■ Work Credentials

■ **Folding Rear Seat-Back**—versatility of over 74 cu. ft. of cargo space when down, six passenger comfort when up ■ **Tow Hooks**—easily accessible, a strong attaching point for chains or tow straps ■ **Steel Ladder-Type Frame with Drop Center Design**—reduced step-in height for easy entry/exit, high ground clearance for off-road driving

■ Easy

—**TO OWN** ■ **Solar-Ray Light Tinted Glass**—screens out much of the sun's ultraviolet and infrared rays to help keep interior cool, helps reduce fading and deterioration of interior fabrics/trim ■ **Convenience Tray**—easy to reach, under instrument panel

—**ON THE MIND** ■ **Four-Wheel Anti-Lock Brake System**—reduces chance of wheel lockup helping driver maintain control during severe braking, even on slippery surfaces ■ **Seat Belts, Lap and Shoulder**—belts in all outboard seating positions, provide enhanced occupant protection in the event of a collision (lap belt only on inboard seating) ■ **Side-Guard Door Beams**—beams resist flexing and absorb energy in side impacts, reducing chance of injury ■ **Roadside Assistance**—24-hour service assistance via Chevrolet's toll-free "800" number. Fast response for towing, repairs, and other services

■ Reliability/Durability

■ **Hot-Wax Coated Box Section Front Frame**—resists corrosion for long-lasting durability ■ **Serpentine Accessory Drive Belt**—automatic tension adjustment, designed to provide longer service life than conventional belt systems ■ **Double Wall Body Panels/Endgate**—keeps damage on the inside from showing on the outside, helps to keep the truck looking new ■ **Bumper-to-Bumper Plus Warranty**—3-year/36,000-mile, no-deductible limited warranty, includes parts, labor. 6-year/100,000-mile body sheet metal rust-through protection, 5-year/50,000-mile emissions control system coverage. (Tires covered by their manufacturer.)

RED ■ : New Feature
BLACK ■ : Focus Vehicle Feature

FEATURE VEHICLE: FOUR-DOOR S-BLAZER 4X4
TAHOE LT

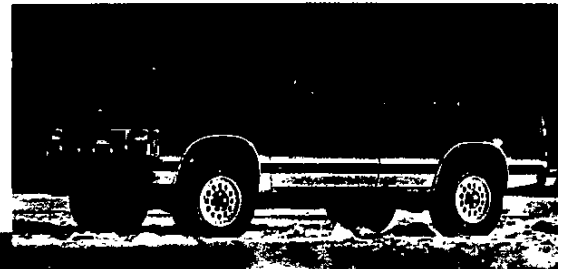

FOCUS
VEHICLE:
FOUR-DOOR
S-BLAZER
4X4 TAHOE

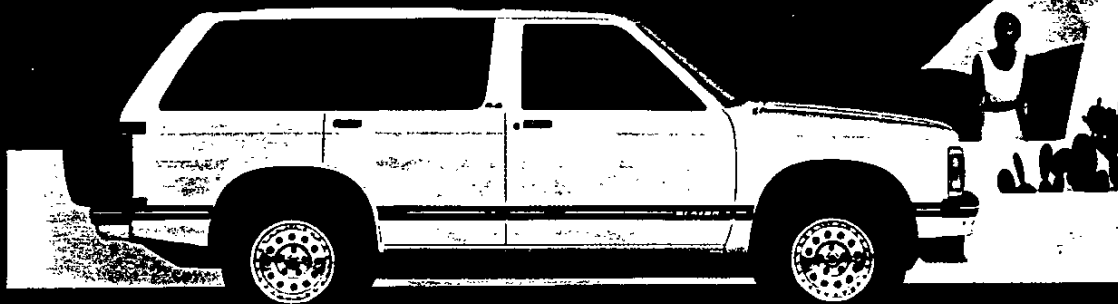

'94 S-Blazer

Trim Color/Seat Style Availability

Custom Vinyl
available in Charcoal
and Gray



Reclining high-back
bucket seats with
folding seat backs, easy
entry passenger side
(2-door only)—
standard on base
two-door

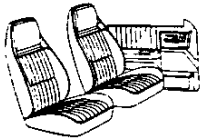

Deluxe Cloth
available in Beige,
Blue, Charcoal
and Gray



Reclining high-back
bucket seats, manual
adjustable lumbar
support, easy entry
passenger side (2-door
only)—
standard on Tahoe
(2-door),
optional on base

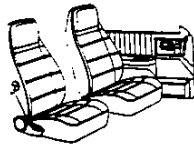

Ultrasoft Leather
available in Beige,
Charcoal and Gray



Reclining high-back
bucket seats with
folding seat backs, dual
power lumbar
adjustment and dual
six-way power, easy-
entry passenger side
(2-door only)—standard
on Tahoe LT

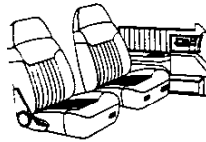

Reclining high-back
bucket seats, power
lumbar support, easy
entry passenger side
(2-door only), six-way
power driver's seat—
optional on
base, Tahoe, Tahoe LT

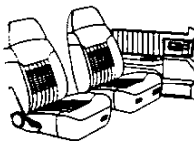

60/40 split bench seat
with recliners, easy
entry passenger side
(2-door only)—standard
on
base four-door

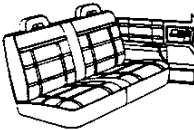

Four Most Popular Exterior Colors By Percentage

Below are the anticipated four most popular S-Blazer colors for 1994 based on national sales volume. They are listed for reference only. To identify the top selling colors in your area, by model, use the Retail Sales Analysis (RSA).



Forest Green Metallic	25%
Midnight Black	20%
Apple Red	16%
Garnet Red	14%

Four Most Popular Exterior Colors with Corresponding Interior Color Availability

EXTERIOR	INTERIOR			
	Beige	Blue	Charcoal	Gray
Forest Green Metallic	■		■	■
Midnight Black	■		■	■
Apple Red	■		■	■
Garnet Red	■		■	■

NOTE: All S-Blazer exterior colors are the same for 1994.

Wheels

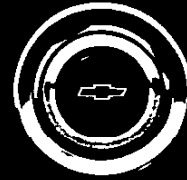

Standard wheel
with Black hub cap
and optional trim ring

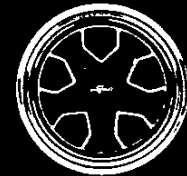

Optional 15" Rally Wheel - 2WD,
standard on Tahoe

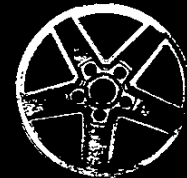

Optional 15" silver-color cast-
aluminum wheel - 2WD models

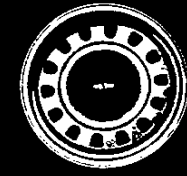

Standard 15" steel wheel - 4WD

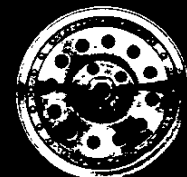

Optional
15" special aluminum wheel -
standard on 4WD Tahoe LT,
optional on other 4WD models

'94 S-Blazer

'94 Product Positioning

The popularity of the S-Blazer continues. This vehicle sets the standard for dependability, performance and style in a highly versatile package. The Two-Door S-Blazer has a sport orientation, while the Four-Door version is popular with family-oriented buyers who need more passenger capacity. S-Blazer has excellent towing capacity and can fill many roles on and off the road. The majority of buyers opt for S-Blazer's 4WD Insta-Trac (with optional RPO NP1 Electric Transfer Case) and uplevel trim.

Feature Vehicle:

Four-Door S-Blazer 4x4 Tahoe LT

The Four-Door S-Blazer 4x4 Tahoe LT with Preferred Equipment Group LTA1 (PEG 1) is selected to be the 1994 Feature Vehicle. Its rugged chassis easily handles spirited off-road driving and its Tahoe trim let's you look good doing it. Standard features include the above, plus:

- Body: Standard
- Convenience Group: Tilt-Wheel and Cruise Control
- Deep-Tinted Glass

Notes

Focus Vehicle: Four-Door S-Blazer 4x4 Tahoe Ordering Recommendations

The recommended Four-Door S-Blazer 4x4 Tahoe content, based on national sales volume, is listed below to assist your dealership in ordering.

Four-Door S-Blazer 4x4 Tahoe with Preferred Equipment Group 3 (DAA3)

- Air Conditioning
- Driver Convenience: Electric Tailgate Release and Rear Window Defogger
- Luggage Carrier
- Operating Convenience Package: Power Door Locks and Power Windows
- AM/FM Stereo with Seek/Scan, Cassette Tape, Digital Clock and Dual Rear Speakers
- Aluminum Wheels
- Wiper/Washer, Rear Window

NOTE: Model, PEG and optional content may vary in your locality. Use the Retail Sales Analysis (RSA) to verify or select your dealership's S-Blazer Focus Vehicle content.

'94 S-Blazer

Forecasted Percent of Mix

Series

S-Blazer 2WD	20%
S-Blazer 4WD	80%
Total	100%

Models

2-Door	20%
4-Door	80%
Total	100%

Trim Levels

Standard	1%
Tahoe	69%
Tahoe LT	30%
Total	100%

Engines

4.3L EFI	9%
4.3L CPI	91%
Total	100%

Transmissions

5-Speed Manual with Overdrive	9%
4-Speed Electronically Controlled Automatic with Overdrive	91%
Total	100%

Additional Information on Significant Features

- S-Blazer offers standard **4-Wheel Anti-Lock Brakes**, which reduce the chance of wheel lockup helping driver maintain control during severe braking. When wheel sensors detect an impending lockup, the control unit modulates brake pressure to the appropriate brake lines, helping to improve steering control even on slippery surfaces.
- **Two-Stage Variable-Rate Multi-Leaf Springs** on the rear suspension provide an excellent ride for passengers under light loads, yet under heavy loads springs compress to the second stage to provide strong support capability.
- Chevrolet's **Insta-Trac System** allows shifting from 2WD to 4WD High and back while driving at any speed. Unlike some systems where the vehicle must be stopped, and even driven backwards to fully disengage the front-drive system, Insta-Trac just requires moving the floor mounted lever, or pushing the optional dash-mounted switch (RPO NP1) at any speed.

Deletions

- Cast-aluminum wheel (Honeycomb pattern RPO N60) is no longer offered on 2WD models due to low demand.

MODELS**PASSENGERS**

4-Door Blazer 2-Wheel Drive (CS10506)	3/5
4-Door Blazer 4-Wheel Drive (CT10506)	6/5

DIMENSIONS

Wheelbase (inches)	
C*10506	107
Length (overall - inches)	
C*10506	176.8
Width, Maximum (inches)	65.4
Cargo Length (inches)	
C*10506	
w/rear seat up	38.5
w/rear seat folded	76.1
Payload (max. pounds) - (Including Passengers and Cargo)	
CS10506	1453/1487
CT10506	1324/1336
GVWR (pounds)	
CS10506	4850
CT10506	5100
Fuel Tank Capacity	20 Gal.

POWER TEAMS

Standard Power Team
RPO R8Y 4.3 Liter (CPI) V6 Engine, 4-Speed
Electronically Controlled Automatic Transmission
w/Overdrive and Engine and Trans Oil Coolers

STANDARD EQUIPMENT SUMMARY**STANDARD TRIM LEVEL****EXTERIOR**

Alternator: 100 Amps
Battery: 525 Cold cranking Amps
Brakes: Power assisted, front disc, rear drum, four wheel
anti-lock braking system
Bumpers, Front and Rear: Chrome w/black rub strips and
bright inserts
Door Handles: Black Finish
Engine Compartment Lamp
Glass, Tinted: Solar-Ray (All Windows)
Grille: Chrome and gray
Headlamps, Halogen
Horn: Dual Note
Mirrors, Exterior: LH and RH below-eye-line type, black
Molding: Black body side w/bright inserts, bright wheel
opening and black windshield

EXTERIOR (Cont'd)

Side Guard Door Beams
Stop Lamp, Center High Mount
Suspension, Front Independent:
 S10: Coil springs
 T10: Torsion bar
Suspension, rear semi-floating axle, 2-stage leaf springs
Tire: P205/75R15 All Season B/W
Tire/Wheel: Full-size tire and wheel and spare
tire cover, inside mounted
Tow Hooks, Front: (T10 only) (2)
Wheels:
 S10: 15 x 6 Rally w/black center cap;
 Argent w/trim rings
 T10: 15 x 6 Steel with black center cap;
 Argent w/trim rings
Transfer Case: Electronic Shift (T10 only)
Windshield Wipers: Intermittent (Adjustable)

INTERIOR

Armrests, Padded: LH and RH integral with door panels
Cigarette Lighter and Ash Tray Lights
Coat Hooks: RH and LH rear seat (2)
Convenience Tray under instrument panel
Defogger, Side Windows and Deluxe Heater
Door Trim Panels: Color-keyed deluxe cloth upper
inserts, carpeted lower inserts and map pockets with
coin holder in LH door
Floor Covering: Color-keyed carpeted with front and rear
carpeted removable floor mats
Grab Handles: Front and rear passenger positions
Headlamp-on warning buzzer
Headliner: Color-keyed, cloth cover
Instrument: Warning lights for seat belt, ABS/parking
brake, direction/hazard signals and high-beam. Gage
package includes voltmeter, oil pressure and engine
temperature gages, fuel gage, trip odometer and
speedometer
Insulation: Dash panel, doors, floor and underhood,
instrument panel and cowlfender seal
Lamps, Interior: Door-operated dome and front floor
courtesy
Mirror, Interior Rearview: Day/night with dual reading
lamps and illuminated entry feature
Moldings and Trim Panels: Front pillar, center pillar, rear
quarter and tailgate
Radio: ETR AM with digital clock (Incls 2 speakers)
Seat and Shoulder Belts: Color-keyed
Seats: 60/40 deluxe cloth split bench with recliners
and passenger side easy-entry feature (Incls armrest
with storage and dual cupholders) Optional bucket
seats incl seat separator console

STANDARD EQUIPMENT SUMMARY**INTERIOR (Continued)**

Steering, Power
 Steering Wheel: Deluxe 4-spoke, black
 Stowage Box: RH side of instrument panel with door
 activated light
 Sunshades, dual padded with extenders, convenience
 strap and illuminated vanity mirrors
 Tools: Jack with cover and wheel wrench

S/T BLAZER LT

The following equipment is in addition to or replacing
 items included in the standard options

EXTERIOR

Bumpers, Front and Rear: Color-keyed with black rub
 strips
 Carrier: Luggage
 Shock Absorbers: Bilstein (T10 Only)
 Suspension/Tires:
S10: P205/75R15 all season W/L
T10: P235/75R15 all season WOL
 Wheels:
S10: 15 x 7 Cast Aluminum
T10: 15 x 7 Special Aluminum with black center cap;
 Argent

INTERIOR

Door Locks, Power
 Door Trim Panels: Color-keyed ultra soft leather upper
 inserts, carpeted lower inserts and map pockets with
 coin holder in LH door
 Grab Handles: Front and rear passengers
 Keyless Entry, Remote
 Radio: AM/FM Stereo Radio w/seek-scan and digital
 clock
 Seats: Ultrasoft leather reclining high back bucket seats,
 6-way power adjustment for driver and power lumbar
 adjustment for driver and front passenger. Incls leather
 rear folding bench seat w/armrest
 Steering Wheel: Leather wrapped
 Windows, Power

MODEL AND BODY

	Description	Model No	Body		Description	Model No	Body
*17,406.00	2-WHEEL-DRIVE (a)Tailgate 4-Door	MODEL CS10506	E55	*19,640.00	4-WHEEL-DRIVE (b)Tailgate 4-Door	MODEL CT10506	E55

*Includes Destination & Handling Charges

(a) Reqs P16 Spare Wheel Carrier or PNV Carrier Not Desired

(b) Rear Seat Included

EMISSIONS (Must Order One) (Refer Emission Requirements Section)

FE9 Federal Emission Requirements

NG1 New York State Emission Requirements

YF5 California Emission Requirements

NB8 California or New York State Emission Override (Reqs FE9 Federal Emissions)

NC7 Federal Emission Override (Reqs NG1 New York State or YF5 California Emissions)

GVWR SELECTOR

GVW Rating (lbs)	GAWR (lbs)		Minimum Equipment Required For GVW Rating
	Front	Rear	
S10506			
4850	2300	2900	None
T10506			
5100	2500	2900	None

ENHANCED POWER TEAMS (Must Order R8Y AND REAR AXLE)

ENGINE	TRANSMISSION	AXLE	GVWR
		3.42	
S10506			
V6 4.3 Liter CPI	AUTO	GU6	4850
T10506			
V6 4.3 Liter CPI	AUTO	GU6	5100

CAPACITIES

S10506			
SPRINGS:		AXLES:	
Front		Front	
2300		2300	
Rear		Rear	
2900	Base	2900	
T10506			
SPRINGS:		AXLES:	
Front		Front	
2500		2500	
Rear		Rear	
2900	Base	2900	

THE LOWEST NUMERICAL AXLE RATIO HAS BEEN ENGINEERED TO COVER THE WIDEST RANGE OF APPLICATIONS AND OFFER THE BEST FUEL ECONOMY

REVISED: 1-10-94

1994 ORDER GUIDE

S/T BLAZER

Page 3

Prices Shown Are Manufacturer's Suggested Retail Prices (MSRP) At The Time Of Publication. These Prices Are To Be Used Only As An Aid To Inventory Management Since MSRP Figures Change Periodically. The Vehicle Price Schedule Is The Official Pricing Documentation Of Chevrolet Motor Division And Should Be Used In Discussing Vehicle Prices With Potential Buyers. The Model Prices Shown In The Order Guide Include The Destination Freight Charges.

AXLE, EMISSION, PEG AND TIRES MUST BE ORDERED

REQUIRES R8Y ENHANCED POWER TRAIN AND SOLID PAINT

TAHOE	
D	
D	
D	
1	

3,590.00	Preferred Equipment Group		
3,310.00	S10506		
(-1200.00)	T10506		
	Marketing Adjustment		
	Body: Standard	E55	x
	Tahoe Equipment	YC2	x
	Air Conditioning	C60	x
	Convenience Group: Tilt Steering Wheel and Speed Control	ZQ3	x
	Driver Convenience: Electric Tailgate Release and Rear Window Defogger	ZM8	x
	Glass: Deep Tinted w/Light Tinted Rear Window (A)	AA3	x
	Luggage Carrier	V54	x
	Operating Convenience Package: Power Door Locks and Power Windows	ZQ2	x
	Radio: ETR AM/FM Stereo w/Seek-Scan, Cassette Tape and Clock (B)	UM6	x
	Seats: Reclining High Back Buckets (C)	D**6	x
	Seating, Rear, Folding (Std on T10506) (Incl w/S10506 Only)	AM7	x
	Tires: QCF P205/75R15 W/L (D)	QCF	x
	Transfer Case (T10 Only)	NP1	x
	Wheels: Aluminum (S10 Only)	PA3	x
	Wheels: Aluminum (T10 Only)	5P2	x
	Window Wiper/Washer, Rear	C25	x

*The Preferred Equipment Group MSRP's Reflect the Basic Group Equipment Prices. For any Option Additions, Upgrades, or Substitutions, Refer to the Vehicle Price Schedule for any Price Differential.
 **PEG Savings Amount represents the savings for Preferred Equipment Groups.

Allowable Substitutions (Where Available):

- (A) AA3: May substitute AJ1 Glass
- (B) UM6: May substitute UX1 or U1C Radio
- (C) D**6 Reclining High Back Bucket Seats: May be substituted w/D**8 Power Buckets
- (D) QCF: May substitute QFN or QEB Tires (T10 Only)

TAHOE LT	
L	
T	
A	
2	

4,826.00	LT Preferred Equipment Group		
4,783.00	S10506		
(-1300.00)	T10506		
	Marketing Adjustment		
	LT Trim	YC9	x
	Body-Standard	E55	x
	Air Conditioning	C60	x
	Convenience Group: Tilt Wheel and Cruise Control	ZQ3	x
	Driver Convenience: Electric Tailgate Release and Rear Window Defogger	ZM8	x
	Glass: Deep Tinted w/Light Tinted Rear Window (A)	AA3	x
	Radio: ETR AM/FM Stereo w/Seek-Scan, Cassette Tape and Clock (B)	UM6	x
	Suspension: Soft Ride (T10506 Only)	FE1	x
	Transfer Case (T10 Only)	NP1	x
	Window Wiper/Washer, Rear	C25	x

**PEG Savings Amount represents the savings for Preferred Equipment Groups.

Allowable Substitutions (Where Available):

- (A) AA3: May substitute AJ1 Glass
- (B) UM6: May substitute UX1 or U1C Radio

INCL. W/P.E.G. OPTION			
N.C.		R8S	ACKNOWLEDGEMENTS:
N.C.		R8T	Multiple Order Numbers
N.C.	1,2	C60	Preliminary Invoice
115.00		ANL	AIR CONDITIONING
N.C.		GU6	AIR DAM WITH FOG LAMPS: (S10 Only)
252.00		G80	AXLES, REAR: (Refer Power Teams Chart for Availability) (Must Order)
N.C.		UA1	3.42
56.00			Locking Differential
N.C.	1,2	E55	BATTERY: Heavy-Duty, 600 Cold Cranking Amps Delco Freedom (Incl w/V10 Cold Climate)
159.00		PNV	w/V10 Cold Climate
109.00		P16	w/o V10 Cold Climate
83.00		V10	BODY CODE: Tailgate (Refer Model and Body Section)
		DK6	CARRIERS: (Must Order PNV or P16 Carrier)
N.C.	1	ZQ2	Outside Spare Tire Carrier Not Desired
N.C.	1,2	ZQ3	Outside Spare Wheel and Tire Carrier (Incls Cover)
N.C.	1,2	ZM8	COLD CLIMATE PACKAGE: (Incls UA1 Battery and Engine Block Heater)
N.C.		FE9	CONSOLE: Overhead (Incl w/YC9 LT)
N.C.		NG1	DRIVER CONVENIENCE:
N.C.		YF5	Operating Convenience Package: (Incls Power Door Locks and Power Windows) (Incl w/YC9 LT)
N.C.		NB8	Tilt Steering and Speed Control
N.C.		NC7	Rear Window Convenience Package (Incls Electric Tailgate Release and Rear Window Defogger)
1390.00		R8Y	EMISSIONS SYSTEMS: (REFER EMISSIONS REQUIREMENT TAB SECTION)
(-230.00)		---	Federal Emission Requirements
N.C.	1,2	AA3	New York State Emission Requirements
81.00		AJ1	California Emission Requirements
135.00	1	AX3	California or New York State Emission Override (Reqs FE9 Federal Emissions)
N.C.		V54	Federal Emission Override (Reqs NG1 New York State or YF5 California Emissions)
83.00		D48	ENHANCED POWERTRAIN: (Incls Enhanced 4.3L Central Port Injected V6 Engine, 4-Speed Electronically Controlled
13.00		B74	Automatic Transmission w/Overdrive and Engine and Trans Oil Coolers)
N.C.		ZY1	ENHANCED POWERTRAIN SAVINGS: (Incl w/R8Y Enhanced Powertrain)
N.C.	1,2	UM6	GLASS:
150.00		UX1	Deep Tinted w/Light Tinted Rear Window
284.00		U1C	Deep Tinted
N.C.	1	D**6	KEYLESS ENTRY, REMOTE: (Incl w/YC9 LT)
(-650.00)		D**8	LUGGAGE CARRIER: Black (Incl w/YC9 LT)
290.00		A**8	MIRRORS: Exterior, Electric Remote
N.C.			MOLDINGS: Wheel Opening, Black
N.C.	1	AM7	PAINT, EXTERIOR: (Refer Trim Chart for Availability)
358.00	2	FE1	Solid
N.C.		QCF	RADIO:
165.00		QFN	Electronically Tuned AM/FM Stereo Radio w/Seek-Scan, Stereo Cassette Tape and Digital Clock
N.C.	1	QEB	(Incls Premium Speakers)
214.00		Z82	Electronically Tuned AM Stereo/FM Stereo Radio w/Seek-Scan, Stereo Cassette Tape with Search and
210.00		NP1	Repeat, Graphic Equalizer and Digital Clock (Incls Premium Speakers)
N.C.	1,2	PA3	Electronically Tuned AM Stereo/FM Stereo Radio w/Seek-Scan, Compact Disc Player and Digital Clock
N.C.	1	5P2	(Incls Premium Front and Rear Speakers)
N.C.	1,2	C25	SEAT TRIM: (Refer Color and Trim Chart for Availability) Console, Seat Separator: Includes dual cupholders,
			floor tray and auxiliary power outlet
			Deluxe Cloth Reclining High Back Buckets w/Manual Lumbar Adjustment
			Deluxe Cloth Reclining High Back Buckets w/Power Lumbar Adjustment w/6-Way Power Driver Seat
			w/LTA2
			w/o LTA2
			Ultrasoft Leather Reclining High Back Buckets with Power Lumbar Adjustment w/6-Way Power Driver's Seat
			(Reqs LTA2)
			SEATING: (Must order AM7 on S10506 Model)
			Rear, Folding 3-Passenger (Std on T10506) (Incls Center Arm Rest w/D**8 Trim)
			SUSPENSION PACKAGE: Soft Ride (T10506 Only) (Reqs QFN Tires) (Incls Bilstein Shock Absorbers)
			(Deletes Std Tow Hooks)
			w/DDD1
			w/LTA2
			TIRES: (B/W: Blackwall, W/L: White Lettered, W/O: White Outlined) (Incls Full-Size Spare Tire)
			(P235 Tires can be Stored Upright in the T10506)
			All-Seasons Steel Belted Radial Ply (Front, Rear and Spare)
			P205/75R-15 W/L
			P235/75R-15 WOL (T10 Only) (Reqs GU6 Rear Axle)
			w/DDD1
			w/LTA2
			On-Off Road Steel Belted Radial Ply (Front, Rear and Spare)
			P235/75R-15 WOL (T10 Only) (Reqs GU6 Rear Axle Ratio) (N/A w/LTA2)
			TRAILERING SPECIAL EQUIPMENT: Heavy-Duty (Refer Power Teams Chart for Availability)
			(Incls 7-Lead Wiring Harness, Weight Distributing Hitch Platform and Heavy-Duty Flasher)
			TRANSFER CASE: Electronic Shift (T10 Only)
			WHEELS: (Spare Wheel is Steel)
			Aluminum, Cast (S10 Only) (Incl w/YC9 LT)
			Special Aluminum Wheel (T10 Only) (Incl w/YC9 LT)
			WINDOW WIPER/WASHER, REAR

S/T BLAZER INTERIOR AND EXTERIOR COLOR AVAILABILITY CHART WITH ZY1 SOLID PAINT

PLEASE NOTE: Below are the interior trim color and exterior paint combinations recommended by Chevrolet. They are the only interior and exterior color combinations available.

TRIM LEVEL Seat Type	Decor	INTERIOR COLORS			
		Beige	Blue	Charcoal	Gray
TAHOE LT Ultrasoft Leather Reclining High Back Bucket Seats (Power)	YC9	AUU8		AJJ8	AGQ8
Deluxe Cloth Reclining High Back Bucket Seats (Power)		DUU8		DJJ8	DQG8
TAHOE Deluxe Cloth Reclining High Back Bucket Seats (Manual)	YC2	DUU6	*DDD6	DJJ6	DQG6
Deluxe Cloth Reclining High Back Bucket Seats (Power)		DUU8	*DDD8	DJJ8	DQG8

EXTERIOR COLORS	Color Code 1	Color Code 2	RECOMMENDED INTERIOR TRIM COLORS			
BLACK, MIDNIGHT	19	19	x		x	x
BLUE, ASPEN (Met)	24	24		x	x	x
BLUE, ROYAL (Met)	47	47		x		x
GARNET	48	48	x		x	x
GRAY, DOVE	18	18			x	x
GRAY, STEEL (Met)	90	90			x	x
GREEN, FOREST (Met)	44	44	x		x	x
KHAKI	52	52	* x		x	** x
RED, APPLE	72	72	x		x	x
WHITE, FROST	12	12	x	x	x	x

* N/A YC9

** N/A YC2

S/T BLAZER Paint Applications

SOLID PAINT - ZY1

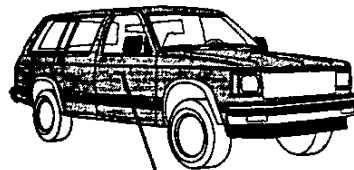

Color Code 1

INTERIOR (Cont'd) (2-DOOR MODEL)

Steering, Power
 Steering Wheel: Deluxe 4-spoke, black
 Stowage Box: RH side of instrument panel with door activated light
 Sunshade, Padded: Color-keyed
 Tools: Jack with cover and wheel wrench

**4-DOOR MODEL
 STANDARD EQUIPMENT SUMMARY****(UPLEVEL YC2 ON 2-DOOR MODEL)****EXTERIOR**

Alternator: 100 Amps
 Battery: 525 Cold Cranking Amps
 Brakes: Power front disc, rear drum, 4-wheel anti-lock braking system
 Bumpers, Front and Rear: Chrome with black rub strips and bright inserts
 Door Handles: Black Finish
 Engine Compartment Lamp
 Glass, Tinted: Solar-Ray (All Windows)
 Grille: Chrome and Gray
 Headlamps, Halogen
 Horn: Dual Note
 Mirrors, Exterior: LH and RH below-eye-line type, black
 Moldings: Body side, black with bright inserts
 Moldings: Wheel opening, bright
 Moldings: Windshield, black
 Side Guard Door Beams
 Spare Tire/Wheel: Full-size tire and steel wheel and spare tire cover
 Stop Lamp, center high mount
 Suspension, Front Independent:
 S10: Coil springs
 T10: Torsion Bar two-stage multi-leaf spring
 Suspension, rear semi-floating axle, 2-stage leaf springs
 Tires: P205/75R15 all season b/w
 Tires, Spare: Full-size mounted inside
 Tow Hooks, Front: (T10 only) (2)
 Wheel Trim Rings, Bright (T10 only)
 Wheels:
 S10: 15 x 7 Rally with black center cap; argent
 T10: 15 x 7 Steel with black center cap; argent
 Transfer Case: Manual Shift (T10 only)
 Transmission: 5-speed manual
 Windshield Wipers: Intermittent (Adjustable)

INTERIOR

Armrests, Padded: LH and RH integral with door panels
 Cigarette Lighter and Ash Tray Lights
 Console, Seat Separator: **2-Door Model Only**
 With manual transmission includes coin tray; with automatic transmission includes dual cupholder, floor tray and auxiliary power outlet
 Convenience Net, Parcel Restraint: **2-Door Model Only**
 In cargo area
 Convenience Tray under Instrumental Panel
 Defogger, Side Windows and Deluxe Heater
 Door Trim Panels: Color-keyed deluxe cloth upper inserts, carpeted lower inserts and map pockets with coin holder in LH door
 Floor Covering: Color-keyed carpeting, full floor,
 Extended Cab includes front and rear removable floor mats
 Grab Handles: Front and rear passenger positions
 Headlamp-on Warning Buzzer
 Headliner: Color-keyed cloth cover
 Hooks: (2) LH and RH rear seat
 Instruments: Warning lights for seat belt, ABS/parking brake, direction/hazard signals and high-beam. Gage package includes oil pressure, engine temperature gages, fuel gage, speedometer, trip odometer and voltmeter
 Insulation: Dash panel, doors, floor and underhood, instrument panel and cowlfender seal
 Lamps, Interior: Door-operated dome and front floor courtesy
 Mirror, Interior Rearview: Day/night with dual reading lamps and illuminated entry feature
 Moldings and Trim Panels: Front pillar, center pillar, rear quarter and tailgate
 Radio: ETR AM with digital clock (Incls 2 speakers)
 Seat and Shoulder Belts: Color-keyed
 Seats: **4-Door Model** 60/40 deluxe cloth split bench with recliners and passenger side easy-entry feature (Incls armrest with storage and dual cupholders) Optional bucket seats incl seat separator console
 Steering, Power
 Steering Wheel: Deluxe 4-spoke, black
 Stowage Box: RH side of instrument panel with door activated light
 Sunshades, dual padded with extenders, convenience strap and illuminated vanity mirrors
 Tools: Jack with cover and wheel wrench



•

•

71



MODELS PASSENGERS

2-Door Blazer 2-Wheel Drive (CS10516)	2
2-Door Blazer 4-Wheel Drive (CT10516)	2
4-Door Blazer 2-Wheel Drive (CS10506)	3
4-Door Blazer 4-Wheel Drive (CT10506)	6

DIMENSIONS

Wheelbase (inches)	
C*10516	100.5
C*10506	107
Length (overall - inches)	
C*10516	170.3
C*10506	176.8
Width, Maximum (inches)	65.4
Cargo Length (inches)	
C*10516	
w/rear seat up	31.8
w/rear seat folded	68.6
C*10506	
w/rear seat up	38.5
w/rear seat folded	76.1
Payload (max. pounds) - (Including Passengers and Cargo)	
CS10516	1129
CT10516	1164
CS10506	1453
CT10506	1324
GVWR (pounds)	
CS10516	4350
CT10516	4700
CS10506	4850
CT10506	5100
Fuel Tank Capacity	20 Gal.

POWER TEAMS

Standard Engine	
RPO LB4 4.3 Liter V6 with Electronic Fuel Injection (EFI)	
Standard Transmission	
RPO MM5 5-Speed Manual w/Overdrive	

2-DOOR MODEL STANDARD EQUIPMENT SUMMARY

STANDARD TRIM LEVEL

EXTERIOR

Alternator: 100 Amps
 Battery: 525 Cold cranking Amps
 Brakes: Power assisted, front disc, rear drum, four wheel
 anti-lock braking system
 Bumpers, Front and Rear: Lower-body color with black
 rub strips

EXTERIOR (Cont'd)

Door Handles: Black Finish
 Engine Compartment Lamp
 Glass, Tinted: Solar-Ray (All Windows)
 Grille: Black
 Headlamps, Halogen
 Horn: Dual Note
 Mirrors, Exterior: LH and RH below-eye-line type, black
 Molding, Windshield: Black
 Side Guard Door Beams
 Stop Lamp, Center High Mount
 Suspension, Front Independent:
 S10: Coil springs
 T10: Torsion bar
 Suspension, rear semi-floating axle, 2-stage leaf springs
 Tire: 205/75R15 All Season B/W
 Tire/Wheel: Full-size tire and wheel and spare
 tire cover, inside mounted
 Tow Hooks, Front: (T10 only) (2)
 Wheels:
 S10: 15 x 6 Steel with brushed aluminum
 hubcap; Argent
 T10: 15 x 6 Steel with black center cap; Argent
 Transfer Case: Manual Shift (T10 only)
 Windshield Wipers: Intermittent (Adjustable)

INTERIOR

Armrests, Padded: LH and RH integral with door panels
 Cigarette Lighter and Ash Tray Lights
 Coat Hooks: RH and LH rear seat and cargo area (2)
 Convenience Tray under instrument panel
 Defogger, Side Windows and Deluxe Heater
 Door Trim Panels: Color-keyed plastic with integral arm
 rests and map pockets
 Floor Covering: Color-keyed carpeting
 Headlamp-on warning buzzer
 Headliner: Color-keyed, cloth cover
 Instrument: Warning lights for seat belt, ABS/parking
 brake, direction/hazard signals and high-beam. Gage
 package includes voltmeter, oil pressure and engine
 temperature gages, fuel gage, trip odometer and
 speedometer
 Insulation: Dash panel, doors, floor and underhood,
 instrument panel and cowl/fender seal
 Lamps, Interior: Door-operated dome and front floor
 courtesy
 Mirror, Interior Rearview: Day/night
 Moldings and Trim Panels: Front pillar, center pillar, rear
 quarter and tailgate
 Radio: ETR AM with digital clock (Incls 2 speakers)
 Seat and Shoulder Belts: Color-keyed
 Seats: Custom Vinyl reclining high back bucket seats
 with folding seatbacks. Easy-entry feature, passenger
 side



MODEL AND BODY

Description			Model No	Body	Description			Model No	Body
*15,913.00	2-WHEEL-DRIVE		MODEL		*17,709.00	4-WHEEL-DRIVE		MODEL	
	(a)Tailgate	2-Door	CS10516	E55		(a)Tailgate	2-Door	CT10516	E55
*17,203.00	(b)Tailgate	4-Door	(c) CS10506	E55	*19,437.00	(d)Tailgate	4-Door	CT10506	E55

*Includes Destination & Handling Charges

- (a) Reqs AM7 Folding Seat or YG4 Seat Not Desired and P16 Spare Wheel Carrier or PNV Carrier Not Desired
- (b) Reqs P16 Spare Wheel Carrier or PNV Carrier Not Desired
- (c) Reqs AM7 Folding or YG4 Seat not Desired
- (d) Rear Seat Included

EMISSIONS (Must Order One) (Refer Emission Requirements Section)

- FE9 Federal Emission Requirements
- NG1 New York State Emission Requirements
- YF5 California Emission Requirements
- NB8 California or New York State Emission Override (Reqs FE9 Federal Emissions)
- NC7 Federal Emission Override (Reqs NG1 New York State or YF5 California Emissions)

GVWR SELECTOR

GVW Rating (lbs)	GAWR (lbs)		Minimum Equipment Required For GVW Rating
	Front	Rear	
S10516			
4350	2200	2600	None
S10506			
4850	2300	2900	None
T10516			
4700	2400	2700	None
T10506			
5100	2500	2900	None

STANDARD POWER TEAMS (Must Order Engine, Transmission and Rear Axle)

ENGINE	TRANSMISSION	AXLE	GVWR
		3.08	3.42
S105*6			
LB4 V6 4.3 Liter EFI	MM5	(a) GU4	GU6
		(b) GU4	GU6
T105*6			
LB4 V6 4.3 Liter EFI	MM5	(b) GU4	GU6
		(b) GU4	GU6
			4350/4850
			4700/5100

- (a) N/A G80 Locking Differential
- (b) N/A QEB or QFN P235 Tires or G80 Locking Differential

ENHANCED POWER TEAMS (Must Order R8Y AND REAR AXLE)

ENGINE	TRANSMISSION	AXLE	GVWR
		3.08	3.42
S105*6			
V6 4.3 Liter CPI	AUTO	(a) GU4	GU6
		(b) GU4	GU6
T105*6			
V6 4.3 Liter CPI	AUTO	(b) GU4	GU6
		(b) GU4	GU6
			4350/4850
			4700/5100

- (a) N/A G80 Locking Differential
- (b) N/A QEB or QFN P235 Tires or G80 Locking Differential

THE LOWEST NUMERICAL AXLE RATIO HAS BEEN ENGINEERED TO COVER THE WIDEST RANGE OF APPLICATIONS AND OFFER THE BEST FUEL ECONOMY

REVISED: 08-23-93

1994 ORDER GUIDE

S/T BLAZER

Page 3

Prices Shown Are Manufacturer's Suggested Retail Prices (MSRP) At The Time Of Publication. These Prices Are To Be Used Only As An Aid To Inventory Management Since MSRP Figures Change Periodically. The Vehicle Price Schedule Is The Official Pricing Documentation Of Chevrolet Motor Division And Should Be Used In Discussing Vehicle Prices With Potential Buyers. The Model Prices Shown In The Order Guide Include The Destination Freight Charges.

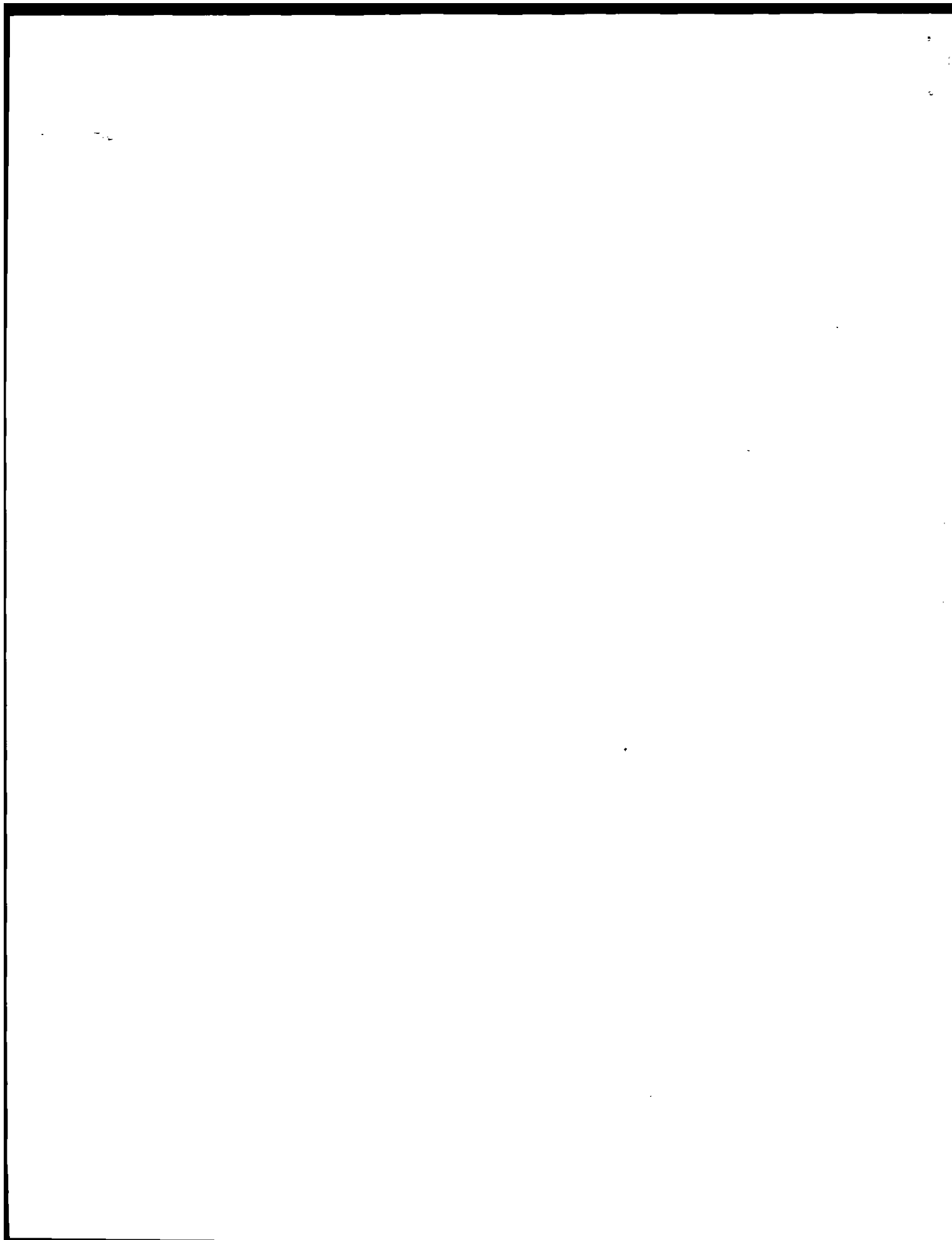

CAPACITIES

S10516		
SPRINGS:		AXLES:
Front		Front
2200		2200
Rear		Rear
2600	Base	2900
S10506		
SPRINGS:		AXLES:
Front		Front
2300		2300
Rear		Rear
2900	Base	2900
T10516		
SPRINGS:		AXLES:
Front		Front
2400		2400
Rear		Rear
2700	Base	2900
T10506		
SPRINGS:		AXLES:
Front		Front
2500		2500
Rear		Rear
2900	Base	2900



AXLE, EMISSION, ENGINE, PEG, TIRE AND TRANSMISSION *MUST* BE SPECIFIED.

No Deletions Allowed. Additional Options/Upgrades (Where Indicated) May be Ordered from the Custom Ordering Option Listing.

		BASE	TAHOE	
		C A A 1	C A A 2	C A A 3
2-DOOR				
N.C.	Preferred Equipment Group 1			
	Body: Standard	E55	x	x
	Tahoe Equipment		x	x
	Preferred Equipment Group 2			
*2178.00	S10516			
*2146.00	T10516			
**(-800.00)	PEG 2 Savings			
	Tahoe Equipment	YC2	x	x
	Convenience Group: Tilt Steering Wheel and Cruise Control	ZQ3	x	x
	Glass: Deep Tinted w/Light Tinted Rear Window (A)	AA3	x	x
	Radio: ETR AM/FM Stereo w/Seek-Scan, and Digital Clock (B)	UM7	x	N/I
	Seat Bucket: W/Manual Adjustable Lumbar Support (C)	D**6	x	x
	Seating: Rear, Folding	AM7	x	x
	Tires: P205/75R15 W/L (D)	QCF	x	x
	Preferred Equipment Group 3			
*4143.00	S10516			
*4143.00	T10516			
**(-1200.00)	PEG 3 Savings			
	Air Conditioning	C60		x
	Driver Convenience: Electric Tailgate Release and Rear Window Defogger	ZM8		x
	Luggage Carrier	V54		x
	Operating Convenience Package: Power Door Locks and Power Windows	ZQ2		x
	Radio: ETR AM/FM Stereo w/Seek-Scan, Cassette Tape and Clock (E)	UM6		x
	Wheels: Aluminum (S10 Only)	PA3		x
	Wheels: Aluminum (T10 Only)	SP2		x
	Window Wiper/Washer, Rear	C25		x

		TAHOE		
		D A A 1	D A A 2	D A A 3
4-DOOR				
N.C.	Preferred Equipment Group 1			
	Body: Standard	E55	x	x
	Tahoe Equipment	YC2	x	x
	Preferred Equipment Group 2			
*1451.00	S10506			
*990.00	T10506			
**(-800.00)	PEG 2 Savings			
	Convenience Group: Tilt Steering Wheel and Speed Control	ZQ3	x	x
	Glass: Deep Tinted w/Light Tinted Rear Window (A)	AA3	x	x
	Radio: ETR AM/FM Stereo w/Seek-Scan and Clock (B)	UM7	x	N/I
	Seats: Reclining High Back Buckets (C)	D**6	x	x
	Seating: Rear, Folding (Std on T10506) (Incl w/S10506 Only)	AM7	x	x
	Tires: P205/75R15 W/L (D)	QCF	x	x
	Preferred Equipment Group 3			
*3565.00	S10506			
*3162.00	T10506			
**(-1200.00)	PEG 3 Savings			
	Air Conditioning	C60		x
	Driver Convenience: Electric Tailgate Release and Rear Window Defogger	ZM8		x
	Luggage Carrier	V54		x
	Operating Convenience Package: Power Door Locks and Power Windows	ZQ2		x
	Radio: ETR AM/FM Stereo w/Seek-Scan, Cassette Tape and Clock (E)	UM6		x
	Wheels: Aluminum (S10 Only)	PA3		x
	Wheels: Aluminum (T10 Only)	SP2		x
	Window Wiper/Washer, Rear	C25		x

**PEG Savings Amount represents the savings for Preferred Equipment Groups.

Allowable Substitutions (Where Available):

- (A) AA3: May substitute AJ1 Glass
- (B) UM7: May substitute UM6, UX1 or U1C Radio
- (C) D**6 Reclining High Back Bucket Seats: May be substituted w/D**8 Power Buckets 4dr models may substitute PA3 for Credit
- (D) QCF: May substitute QJL, QEB or QFN Tires on T10
- (E) UM6: May substitute UX1 or U1C Radio



ADDITIONAL OPTIONS

INCL. W/P.E.G. OPTION			
N.C.		R8S	ACKNOWLEDGEMENTS:
N.C.		R8T	Multiple Order Numbers
	3	C60	Preliminary Invoice
N.C.			AIR CONDITIONING
780.00			w/CAA3/DAA3
115.00		ANL	w/CAA1/DAA1 or CAA2/DAA2
13.00		ZQ9	AIR DAM WITH FOG LAMPS: (S10 Only)
			APPEARANCE PACKAGE, BLACKOUT: (N/A CAA1 or ZY8 Paint) (Incls High Gloss Black Grille, B74, Black Wheel Opening Moldings and Body Colored Bumpers)
			AXLES, REAR: (Refer Power Teams Chart for Availability) (Must Order)
N.C.		GU4	3.08
N.C.		GU6	3.42
252.00		G80	Locking Differential
		UA1	BATTERY: Heavy-Duty. 600 Cold Cranking Amps Delco Freedom (Incl w/V10 Cold Climate)
N.C.			w/V10 Cold Climate
56.00			w/o V10 Cold Climate
N.C.	1,2,3	E55	BODY CODE: Tailgate (Refer Model and Body Section)
			CARRIERS: (Must Order PNV or P16 Carrier)
N.C.		PNV	Outside Spare Tire Carrier Not Desired
159.00		P16	Outside Spare Wheel and Tire Carrier (Recommended for QEB or QFN Tires on T10516) (Incls Cover)
		V10	COLD CLIMATE PACKAGE: (Incls UA1 Battery and Engine Block Heater)
109.00			w/o CAA1
179.00			w/CAA1
145.00		D55	CONSOLE: Seat Separator (Incl w/YC2 Tahoe and Bucket Seats)
83.00		DK6	CONSOLE: Overhead (Reqs Bucket Seats and YC2)
		V08	COOLING SYSTEM: Heavy-Duty (N/A R8Y Powertrain) (Incls radiator and engine oil coolers) (Incl w/Z82 Trailing or Z72 Trailing)
135.00			w/MM5 Trans
			DRIVER CONVENIENCE:
	3	ZQ2	Operating Convenience Package: (Incls Power Door Locks and Power Windows)
N.C.			w/CAA3/DAA3
367.00			w/CAA1/CAA2
542.00			w/DAA1/DAA2
N.C.	2,3	ZQ3	Tilt Steering and Speed Control
383.00			w/o CAA1/DAA1
			w/CAA1/DAA1
N.C.	3	ZM8	Rear Window Convenience Package (Incls Electric Tailgate Release and Rear Window Defogger)
197.00			w/CAA3/DAA3
			w/CAA1/DAA1 or CAA2/DAA2
N.C.		FE9	EMISSIONS SYSTEMS: (REFER EMISSIONS REQUIREMENT TAB SECTION)
		NG1	Federal Emission Requirements
			New York State Emission Requirements
N.C.			w/R8Y
100.00			w/o R8Y
		YF5	California Emission Requirements
N.C.			w/R8Y
100.00			w/o R8Y
N.C.		NB8	California or New York State Emission Override (Reqs FE9 Federal Emissions)
N.C.		NC7	Federal Emission Override (Reqs NG1 New York State or YF5 California Emissions)
N.C.		LB4	ENGINES: 4.3 Liter EFI V6 (Refer Power Teams Chart for Availability)(Reqs MM5 Transmission)
1390.00		R8Y	ENHANCED POWERTRAIN: (Incls Enhanced 4.3L Central Port Injected V6 Engine, 4-Speed Electronically Controlled Automatic Transmission w/Overdrive and Engine and Trans Oil Coolers)
(-230.00)		---	ENHANCED POWERTRAIN SAVINGS: (Incl w/R8Y Enhanced Powertrain)
			FLOOR COVERING:
N.C.		BG9	Full Floor, Rubber Charcoal (Replaces Carpeting) (N/A YC2 Tahoe or B32 or B33 Mats)
		B32	Mats, Carpeted Removable Color-Keyed Floor Mats. Front (Incl w/YC2 Tahoe) (N/A BG9)
N.C.			w/CAA2 or CAA3
25.00			w/CAA1
N.C.		B33	Mats, Carpeted Removable Color-Keyed Floor Mats. Rear (Incl w/YC2 Tahoe) (N/A BG9)
20.00			w/CAA2 or CAA3
			w/CAA1
			GLASS:
N.C.	2,3	AA3	Deep Tinted w/Light Tinted Rear Window
144.00			w/CAA2/DAA2 or CAA3/DAA3
			w/CAA1/DAA1
81.00		AJ1	Deep Tinted (Reqs ZM8 Driver Convenience Pkg)
225.00			w/CAA2/DAA2 or CAA3/DAA3
195.00			w/CAA1/DAA1
135.00		U52	INSTRUMENTATION, ELECTRONIC
		AX3	KEYLESS ENTRY, REMOTE (Reqs Bucket Seats, ZQ2 Driver Convenience Package and ZM8 Rear Window Pkg)
N.C.	3	V54	LUGGAGE CARRIER: Black <i>ALSO Reqs D55 Console w/CAA1</i>
126.00			w/CAA3/DAA3
83.00			w/CAA1/DAA1 or CAA2/DAA2
		D48	MIRRORS: Exterior, Electric Remote (Reqs ZQ2 Convenience Pkg)
13.00		B74	MOLDINGS: Wheel Opening. Black (Incl w/ZQ9 Appearance Pkg)
43.00			w/o CAA1
			w/CAA1
N.C.		ZY1	PAINT, EXTERIOR (Refer Trim Chart for Availability)
227.00		ZY3	Solid
275.00		ZY8	Special Two-Tone (Incls Body Striping)
			Custom Two-Tone (Incls Graduated Body Striping)



ADDITIONAL OPTIONS

	INCL. W/P.E.G. OPTION		
N.C. 131.00	2	UM7	RADIO EQUIPMENT: (Electronically Tuned AM Radio w/Digital Clock Standard) Electronically Tuned AM/FM Stereo Radio w/Seek-Scan and Digital Clock (Incls Premium Speakers) w/CAA2/DAA2 w/CAA1/DAA1
N.C. 122.00 253.00	3	UM6	Electronically Tuned AM/FM Stereo Radio w/Seek-Scan, Stereo Cassette Tape and Digital Clock (Incls Premium Speakers) w/CAA3/DAA3 w/CAA2/DAA2 w/CAA1/DAA1
150.00 272.00 403.00		UX1	Electronically Tuned AM Stereo /FM Stereo Radio w/Seek-Scan, Stereo Cassette Tape with Search and Repeat, Graphic Equalizer and Digital Clock (Incls Premium Speakers) w/CAA3/DAA3 w/CAA2/DAA2 w/CAA1/DAA1
284.00 406.00 537.00 (-95.00)		U1C	Electronically Tuned AM Stereo/FM Stereo Radio w/Seek-Scan Compact Disc Player and Digital Clock (Incls Premium Front and Rear Speakers) w/CAA3/DAA3 w/CAA2/DAA2 w/CAA1/DAA1
N.C.		UL5	Radio Delete (Avail w/CAA1/DAA1 Only)
N.C. 211.00 221.00		X**6 D**6	SEAT TRIM: (Refer Color and Trim Chart for Availability) (Bucket Seats Incl D55 Console w/YG2 Tahoe) Custom Vinyl Reclining High Back Buckets (N/A 4-Door Models) <i>Reqs. CAA1</i> Deluxe Cloth Reclining High Back Buckets w/Manual Lumbar Adjustment w/CAA2/CAA3 or DAA2/DAA3 w/DAA1 w/CAA1
N.C. 290.00 501.00		D**3 D**8	Deluxe Cloth 60/40 Reclining Split Folding Bench Seat (Incls Armrest and Dual Cupholders) CAA1 Deluxe Cloth Reclining High Back Buckets w/Power Lumbar Adjustment w/6-Way Power Driver Seat (Reqs ZQ2 Convenience Pkg) (N/A CAA1) w/CAA2/CAA3 or DAA2/DAA3 w/DAA1
N.C. 409.00 435.00	2,3	AM7	SEATING: (Must Order AM7 or YG4 Seat on S10516-T10516 or S10506 Models) Rear, Folding (2-Passenger on 2-Door Models) (3-Passenger on 4-Door Models) (Std on T10506) (Incls Center Arm Rest w/D**8 Trim) w/CAA2/DAA2 or CAA3/DAA3, CAA1 CAA1 C*10516 w/Vinyl Trim C*10516/CS10506 w/Cloth Trim
N.C. 69.00 75.00		YG4 RYJ ZM5	Rear Seat Not Desired (N/A AM7 Seat) (N/A T10506) (Reqs CAA1/DAA1) SECURITY SHADE: Cargo (Reqs 4-Door Model and P16 Spare Tire Mount) SHIELD PACKAGE: (T10 Only) (Incls Transfer Case, Front Differential Skid Plates, Fuel Tank and Steering Linkage Shield)
N.C. 40.00 63.00		F51	SHOCK ABSORBERS: Front and Rear, Heavy-Duty (N/A S10506) (N/A QFN Tires) (Incl w/F60 Springs) w/F60 Front Springs w/o F60 Front Springs <i>(or 246 Suspension)</i>
122.00 182.00 358.00		F60 ZM6	SPRINGS: Front, Heavy-Duty (T10 Only) (N/A QFN Tires) (Incls F51 Shocks) <i>w/o 246 Suspension</i> SUSPENSION PACKAGE: (N/A F51 Shocks or F60 Suspension) Off-Road (T10516 Only) (Reqs QEB Tires) (Incls Special Gas Shocks, Upsized Torsion Bar, Jounce Bumpers and Stabilizer Bar) (w/o 5P2 Wheels also Incls P06 Trim Rings) w/CAA2 or CAA3 w/CAA1
N.C. 165.00 286.00		FE1	Soft Ride (T10506 Only) (Reqs QFN Tires) (Incls Bilstein Shock Absorbers) (Deletes Std Tow Hooks) TIRES: (B/W: Blackwall, W/L: White Lettered, WOL: White Outlined) (Incls Full-Size Spare Tire) (P235 Tires can be Stored Upright in the T10506) -C*10516-C*10506
N.C. 121.00	2,3	QCE QCF	All-Seasons Steel Belted Radial Ply (Front, Rear and Spare) P205/75R-15 B/W (Reqs CAA1/DAA1) P205/75R-15 W/L w/CAA2/DAA2 or CAA3/DAA3 w/CAA1/DAA1
49.00 170.00		QJL	On-Off Road Steel Belted Radial Ply (Front, Rear and Spare) P205/75R-15 WOL w/CAA2/DAA2 or CAA3/DAA3 w/CAA1/DAA1
N.C. 165.00 286.00		QFN	-CT10516-CT10506 All-Seasons Steel Belted Radial Ply (Front, Rear and Spare) P235/75R-15 WOL (T10 Only) (Reqs GU6 Rear Axle) w/FE1 Soft Ride Suspension w/CAA2/DAA2 or CAA3/DAA3 w/CAA1/DAA1
214.00 335.00		QEB	On-Off Road Steel Belted Radial Ply (Front, Rear and Spare) P235/75R-15 WOL (T10 Only) (Reqs GU6 Rear Axle Ratio) w/CAA2/DAA2 or CAA3/DAA3 w/CAA1/DAA1
109.00 300.00		Z72	TRAILERING PACKAGE: Light-Duty (N/A Z82 Trailering Equip) (w/LB4 Engine Incls V08 Cooling) (Also Incls 5-Lead Wiring Harness and Trailer Hitch) w/R8Y Enhanced Powertrain w/MMS Transmission
210.00 345.00		Z82	TRAILERING SPECIAL EQUIPMENT: Heavy-Duty (Refer Power Teams Chart for Availability) (w/LB4 Eng Reqs GU6 Rear Axle) (Incls 7-Lead Wiring Harness, Weight Distributing Hitch Platform and Heavy-Duty Flasher) (w/LB4 Engine Also Incls V08 Cooling) w/R8Y Enhanced Powertrain w/MMS Transmission

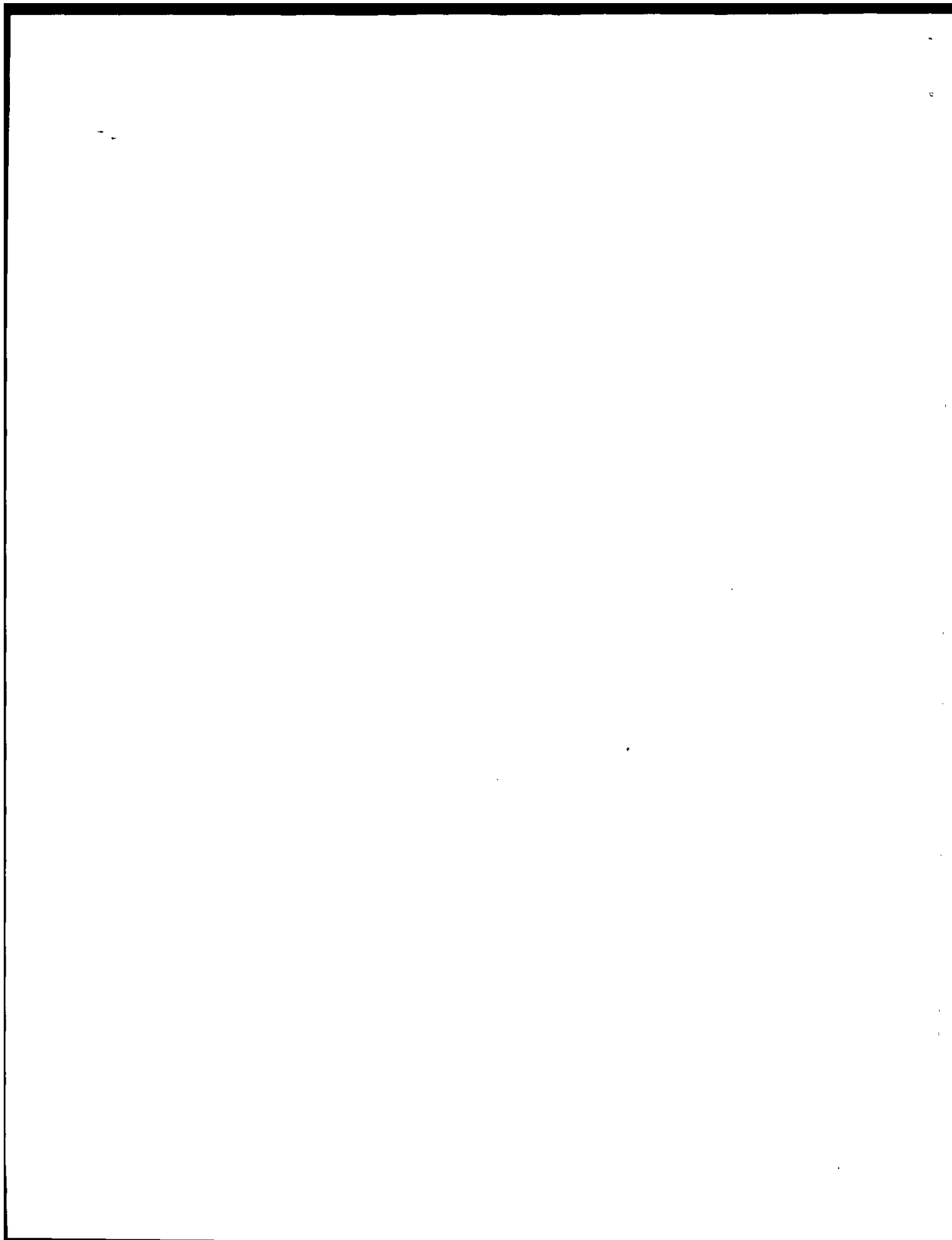

ADDITIONAL OPTIONS

INCL. W/ P.E.G. OPTION			
123.00	NP1	TRANSFER CASE: Electric Shift (T10 Only)	
N.C.	MM5	TRANSMISSIONS: 5-Speed Manual w/Overdrive (Refer Power Teams Chart for Availability) (N/A R8Y Enhanced Powertrain)	
N.C.	P06	WHEEL TRIM: Trim Rings (Incl w/YC2 Tahoe or ZM6 Suspension or ZJ7 Rally Wheels) w/CAA2/CAA3 or w/ZM6 or ZJ7 w/CAA1 w/o ZM6 or ZJ7	
60.00		WHEELS: (Spare Wheel is Steel) Aluminum, Cast (S10 Only) w/CAA3/DAA3 w/DAA1 or CAA2/DAA2 w/CAA1	
N.C.	3 PA3		
248.00			
340.00			
92.00			
N.C.	ZJ7	Rally Wheels with Trim Rings (S10 Only) (Incl w/YC2 Tahoe)	
280.00	3 5P2	Special Aluminum Wheels (T10 Only) (N/A CAA1) w/CAA3/DAA3 w/DAA1 or CAA2/DAA2 or ZM6	
280.00			
257.00			
N.C.	AD5	WINDOW: Sliding side (Reqs AA3 or AJ1 Deep Tinted Glass) (Available 2 Door Only)	
125.00	3 C25	WINDOW WIPER/WASHER, REAR: (Reqs ZM8 Convenience Pkg) w/CAA3/DAA3 w/CAA1/DAA1 or CAA2/DAA2	



1

2

3

4

5

6

7

8

9

10

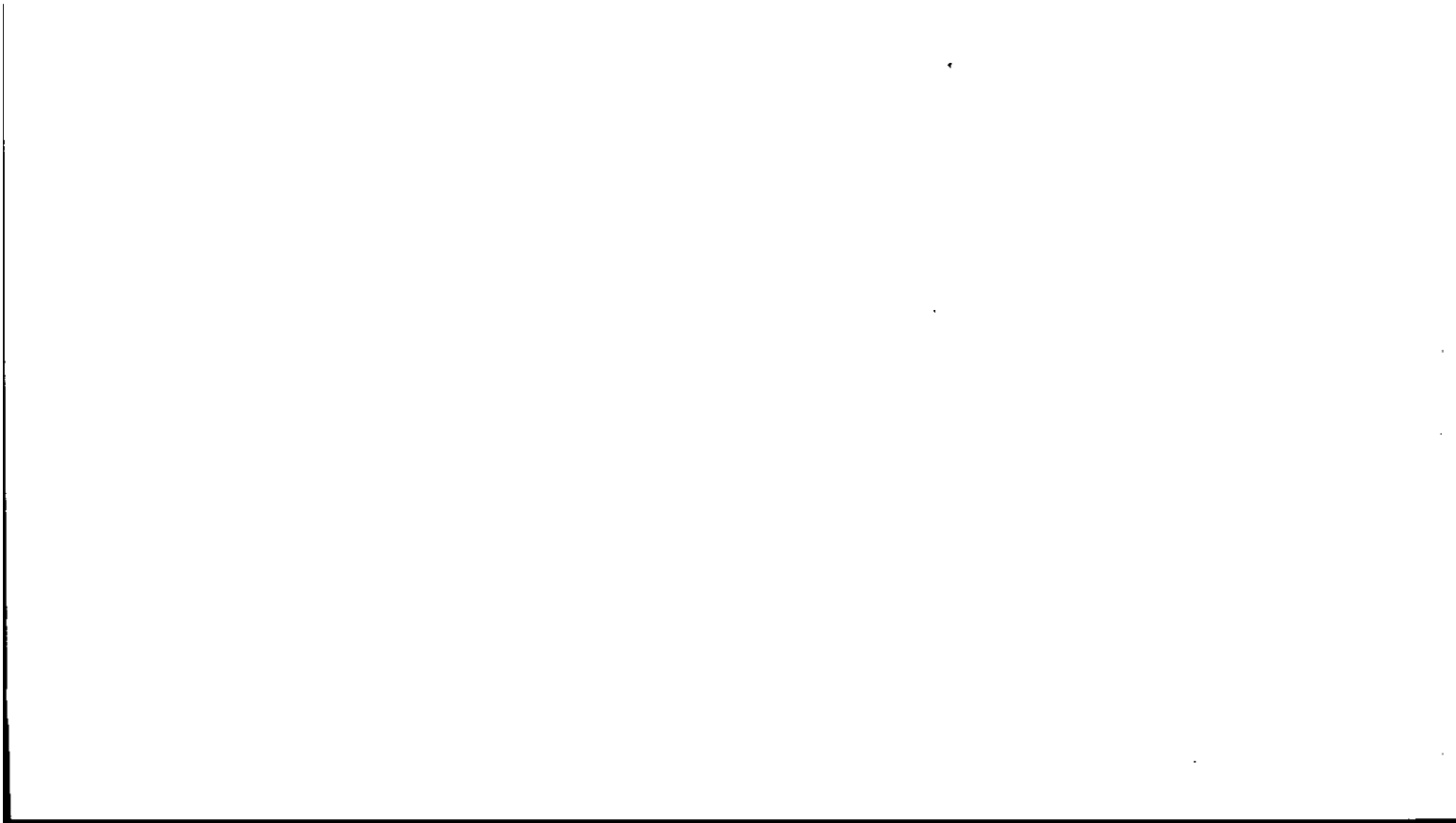

S/T BLAZER
Paint Applications

SOLID PAINT - ZY1



Color Code 1

SPECIAL TWO-TONE PAINT - ZY3

(Incls Body Stripping)

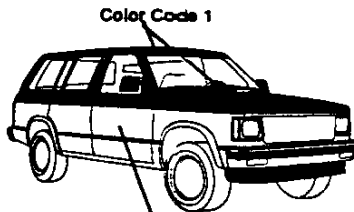

Color Code 2

CUSTOM TWO-TONE PAINT - ZY8

(Incls Graduated Striping)

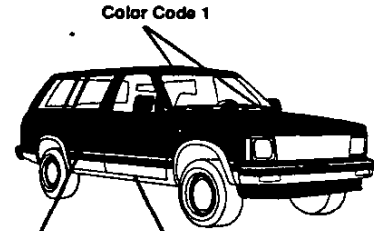

Stripe

Color Code 2

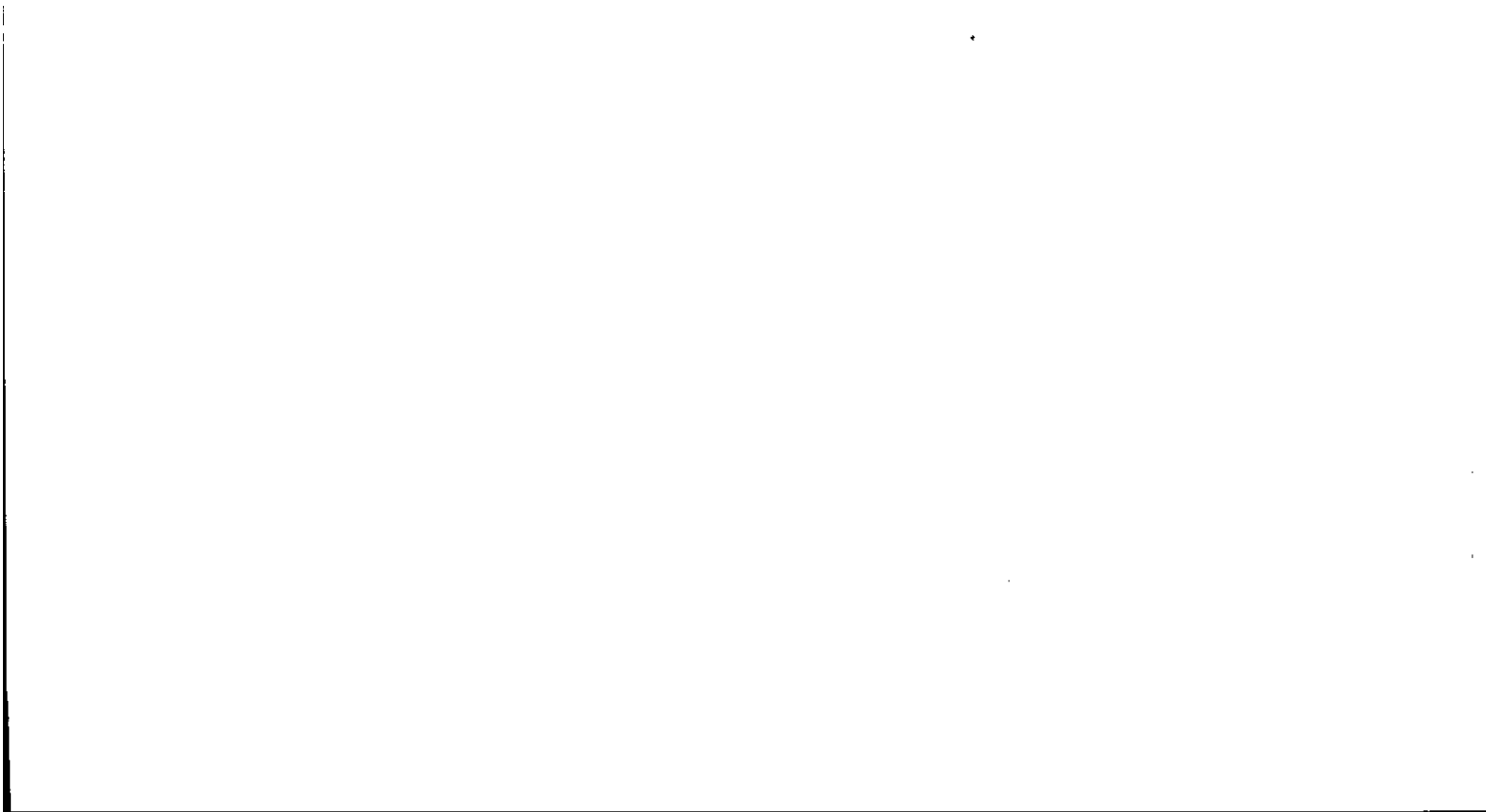

S/T BLAZER INTERIOR AND EXTERIOR COLOR AVAILABILITY CHART WITH ZY1 SOLID PAINT

PLEASE NOTE: Below are the interior trim color and exterior paint combinations recommended by Chevrolet. They are the only interior and exterior color combinations available.

TRIM LEVEL Seat Type	Decor	INTERIOR COLORS			
		Beige	Blue	Charcoal	Gray
* STANDARD INTERIOR (N/A 4-Dr Met) Custom Vinyl Reclining High Back Bucket Seats	Std			XJJ6	XQQ6
Deluxe Cloth Reclining High Back Bucket Seats (Manual)				DJJ6	DDQ6
** TAHOE Deluxe Cloth Reclining Split Bench Seat Deluxe Cloth Reclining High Back Bucket Seats (Manual)	YC2	DUU3	DDD3	DJJ3	DDQ3
*** Deluxe Cloth Reclining High Back Bucket Seats (Power)		DUU6	DDD6	DJJ6	DDQ6
		DUU8	DDD8	DJJ8	DDQ8

EXTERIOR COLORS	Color Code 1	Color Code 2	RECOMMENDED INTERIOR TRIM COLORS			
BLACK, MIDNIGHT	19	19	x		x	x
BLUE, ASPEN (Met)	24	24		x	x	x
BLUE, ROYAL (Met)	47	47		x	# x	x
GARNET	48	48	x		x	x
GRAY, DOVE	18	18			x	x
GRAY, STEEL (Met)	90	90			x	x
GREEN, FOREST (Met)	44	44	x		x	x
KHAKI	52	52	x		x	
RED, APPLE	72	72	x		x	x
WHITE, FROST	12	12	x	x	x	x

- * N/A 4-Door Models (C*10506)
- ** N/A 2-Door Models (C*10516)
- *** Reqs ZQ2 Convenience Package
- # N/A 4-Door Models (C*10506) or YC2 Trim

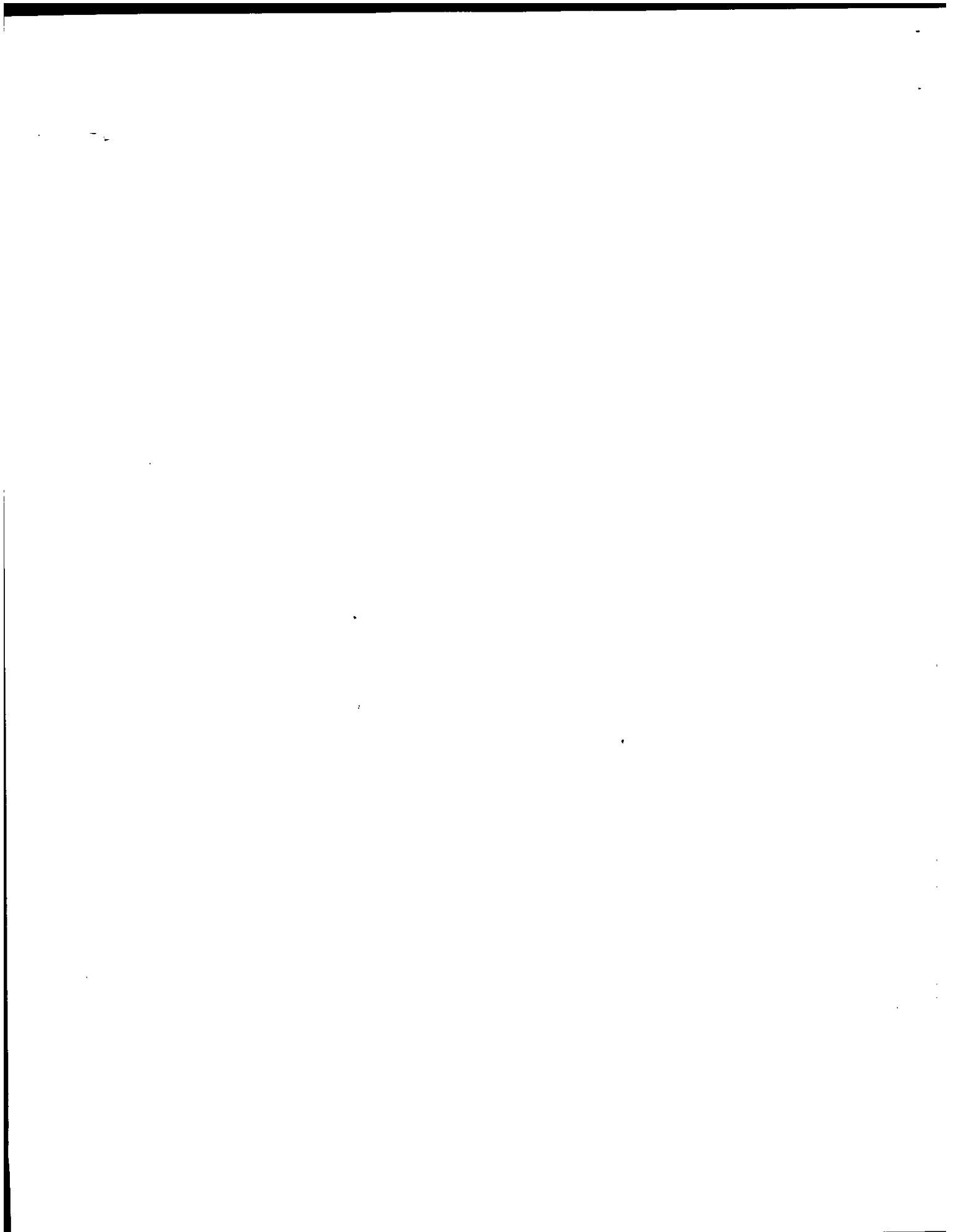

S/T BLAZER
INTERIOR AND EXTERIOR COLOR AVAILABILITY CHART
WITH ZY3 TWO-TONE PAINT

PLEASE NOTE: Below are the interior trim color and exterior paint combinations recommended by Chevrolet. They are the only interior and exterior color combinations available.

TRIM LEVEL Seat Type	Decor	INTERIOR COLORS			
		Beige	Blue	Charcoal	Gray
TAHOE	YC2				
* Deluxe Cloth Reclining Split Bench Seat		DUU3	DDD3	DJJ3	DOQ3
Deluxe Cloth Reclining High Back Bucket Seats (Manual)		DUU6	DDD6	DJJ6	DOQ6
** Deluxe Cloth Reclining High Back Bucket Seats (Power)		DUU8	DDD8	DJJ8	DOQ8

EXTERIOR COLORS	Color Code 1	Color Code 2	RECOMMENDED INTERIOR TRIM COLORS				STRIPE COLOR INCLUDED WITH ZY3 ONLY
BLACK, MIDNIGHT							
Garnet	19	48			x	x	Black
Gray, Steel (Met)	19	90			x	x	Black
Red, Apple	19	72			x	x	Black
Silver (Met)	19	17			x	x	Black
BLUE, ASPEN (Met)							
Blue, Royal (Met)	24	47		x		x	Med Blue (Met)
Silver (Metallic)	24	17		x		x	Med Blue (Met)
BLUE, ROYAL (Met)							
Blue, Aspen (Met)	47	24		x		x	Dk Blue (Met)
Khaki	47	52	x	x			Dk Blue (Met)
Silver (Met)	47	17		x		x	Dk Blue (Met)
GARNET							
Gray Steel (Met)	48	90			x	x	Dk Red
Khaki	48	52	x		x		Dk Red
Silver (Met)	48	17			x	x	Dk Red
GRAY, DOVE							
Black, Midnight	18	19			x	x	Gray, Dove
Garnet	18	48			x	x	Gray, Dove
GRAY, STEEL (Met)							
Black, Midnight	90	19			x	x	Gray (Met)
Garnet	90	48			x	x	Gray (Met)
Red, Apple	90	72			x	x	Gray (Met)
Silver (Met)	90	17			x	x	Gray (Met)
GREEN, FOREST							
Gray, Steel (Met)	44	90			x	x	Fr Green (Met)
Khaki	44	52	x		x		Fr Green (Met)
Silver (Met)	44	17			x	x	Fr Green (Met)
KHAKI							
Blue, Royal (Met)	52	47	x	x			Khaki
Garnet	52	48	x		x		Khaki
Green, Forest (Met)	52	44	x		x		Khaki
RED, APPLE							
Black, Midnight	72	19			x	x	Red
Silver (Met)	72	17			x	x	Red
WHITE, FROST							
Blue, Aspen (Met)	12	24		x		x	White
Khaki	12	52	x		x		White
Silver (Met)	12	17			x	x	White

* N/A 2-Door Models (C*10516)

** Reqs ZQ2 Convenience Package

N/A 4-door Models (C*10506)



S/T BLAZER INTERIOR AND EXTERIOR COLOR AVAILABILITY CHART WITH ZY8 TWO-TONE PAINT

PLEASE NOTE: Below are the interior trim color and exterior paint combinations recommended by Chevrolet. They are the only interior and exterior color combinations available.

TRIM LEVEL Seat Type	Decor	INTERIOR COLORS			
		Beige	Blue	Charcoal	Gray
TAHOE	YC2				
* Deluxe Cloth Reclining Split Bench Seat		DUU3	ODD3	DJJ3	DQQ3
Deluxe Cloth Reclining High Back Bucket Seats (Manual)		DUU6	ODD6	DJJ6	DQQ6
** Deluxe Cloth Reclining High Back Bucket Seats (Power)		DUU8	ODD8	DJJ8	DQQ8

EXTERIOR COLORS	Color Code 1	Color Code 2	RECOMMENDED INTERIOR TRIM COLORS				STRIPE COLOR
BLACK, MIDNIGHT							
Gray, Steel (Met)	19	90			x	x	Gray (Met)
Garnet	19	48			x	x	Dk Red
Khaki	19	52	x				Khaki
Silver (Met)	19	17			x	x	Silver
BLUE, ASPEN (Met)							
Blue, Royal (Met)	24	47		x		x	Dk Blue (Met)
Gray, Steel (Met)	24	90		x		x	Gray (Met)
Silver (Met)	24	17		x		x	Silver
BLUE, ROYAL (Met)							
Gray, Steel (Met)	47	90		x		x	Gray (Met)
Khaki	47	52	x				Khaki
Silver (Met)	47	17		x		x	Silver
GARNET							
Black, Midnight	48	19			x	x	Black
Gray, Steel (Met)	48	90			x	x	Gray (Met)
Khaki	48	52	x				Khaki
Silver (Met)	48	17			x	x	Silver
GRAY, DOVE							
Black, Midnight	18	19			x	x	Black
Gray, Steel (Met)	18	90			x	x	Gray (Met)
Garnet	18	48			x	x	Dk Red
GRAY, STEEL (Met)							
Black, Midnight	90	19			x	x	Black
Blue, Royal	90	47		x		x	Dk Blue (Met)
Garnet	90	48			x	x	Dk Red
Silver (Met)	90	17			x	x	Silver
GREEN, FOREST (Met)							
Khaki	44	52	x				Khaki
Silver (Met)	44	17			x	x	Silver
KHAKI							
Black, Midnight	52	19	x		x		Black
Blue, Royal (Met)	52	47	x	x			Dk Blue (Met)
RED, APPLE							
Black, Midnight	72	19			x	x	Black
Khaki	72	52	x				Khaki
Silver (Met)	72	17			x	x	Silver
WHITE, FROST							
Gray, Steel (Met)	12	90			x	x	Gray (Met)
Khaki	12	52	x				Khaki
Silver (Met)	12	17			x	x	Silver

* N/A 2-Door Models (C*10516)
** Reqs ZQ2 Convenience Package



MODELS PASSENGERS

2-Door Blazer 2-wheel drive (CS10516)	4
2-Door Blazer 4-wheel drive (CT10516)	4
4-Door Blazer 2-wheel drive (CS10506)	5
4-Door Blazer 4-wheel drive (CT10506)	5

DIMENSIONS

Wheelbase (inches)	
C*10516	100.5
C*10506	107
Length (overall - inches)	
C*10516	170.3
C*10506	176.8
Width, Maximum (inches)	65.4
Cargo Length (inches)	
C*10516	
w/rear seat up	31.8
w/rear seat folded	68.6
C*10506	
w/rear seat up	38.5
w/rear seat folded	76.1
Payload (max. pounds) - (Including Passengers)	
CS10516	1129
CT10516	1164
CS10506	1487
CT10506	1336
GVWR (pounds)	
CS10516	4350
CT10516	4700
CS10506	4850
CT10506	5100
Fuel Tank Capacity	20 Gal.

POWER TEAMS

Standard Engine	
RPO LB4 4.3 Liter V6 with Electronic Fuel Injection (EFI)	
Standard Transmission	
RPO MM5 5-speed Manual	

STANDARD EQUIPMENT SUMMARY

EXTERIOR

Alternator: 100 Amps
Battery: 525 Cold Cranking Amps
Brakes: Power front disc, rear drum, 4-wheel anti-lock braking system
Bumpers, Front and Rear: Color-keyed with black rub strips
Door Handles: Black Finish

EXTERIOR (Cont'd)

Glass, Tinted: Solar-Ray, all windows
Grille: Chrome and Gray
Headlamps, Halogen
Horn: Dual Note
Lamp: Engine compartment
Luggage Carrier
Mirrors, Exterior: LH and RH below-eye line type, black
Moldings: Body side, black with bright inserts
Moldings: Wheel opening, bright
Moldings: Windshield, black
Paint, Exterior: ZY8 two-tone
Shock Absorbers: Bilstein
Side Guard Door Beams
Stop Lamp, Center High Mount
Suspension/Tires:
S10: Front coil springs. Rear semi-floating with two stage leaf spring. P205/75R15 all season W/L
T10: Front torsion bar. Rear semi-floating with two stage leaf spring. P235/75R15 all season WOL
Tire/Wheel: Full-size tire and wheel and spare tire cover
Wheels:
S10: 15 x 7 Cast Aluminum
T10: 15 x 7 Special Aluminum with black center cap; Argent
Transfer Case: Manual Shift (T10 only)
Windshield Wipers: Adjustable intermittent

INTERIOR

Armrests, Padded: LH and RH integral with door panels
Cigarette Lighter and Ash Tray Lights
Console: Seat Separator and overhead
With manual transmission includes coin tray
With R8Y Enhanced Powertrain includes dual cupholders, floor tray and auxiliary power outlet
Convenience Net, Parcel Restraint: In cargo area
Convenience Tray under Instrument Panel
Convenience Tray, Floor, with Auxiliary Power Outlet (N/A with Manual Transmission) (4-Door Mdl)
Defogger, Side Windows and Deluxe Heater
Door Locks, Power
Door Trim Panels: Color-keyed ultra soft leather upper inserts, carpeted lower inserts and map pockets with coin holder in LH door
Floor Covering: Color-keyed carpeted with front and rear carpeted removable floor mats
Grab Handles: Front and rear passengers
Headlamp-on Warning Buzzer
Headliner: Color-keyed cloth cover



1
2
3

4

5

6

7

8



INTERIOR (Cont'd)

Hooks, Coat: (2) LH and RH rear seat and cargo area
Instruments: Warning lights for seat belt, parking brake, direction/hazard signals and high-beam. Gage package includes oil pressure, engine temperature gages, speedometer, trip odometer and voltmeter
Insulation: Dash panel, doors, floor and underhood, instrument panel and cowl/fender seal
Keyless Entry, Remote
Lamps Interior: Door-operated dome and front floor courtesy
Mirror, Interior Rearview: Day/night with dual reading lamps and illuminated entry feature
Moldings and Trim Panels: Front pillar, center pillar, rear quarter and tailgate
Radio: AM/FM Stereo Radio w/seek-scan and digital clock
Seat and Shoulder Belts: Color-keyed
Seats: Ultrasoft leather reclining high back bucket seats with folding seatbacks, 6-way power adjustment for driver and power lumbar adjustment for driver and front passenger. Incls leather rear folding bench seat. Easy-entry feature passenger side
Steering, Power
Steering Wheel: Leather wrapped
Stowage Box: RH side of instrument panel with door activated light
Sunshades, Convenience straps, dual padded with extenders and LH and RH illuminated vanity mirrors
Tools: Jack with cover and wheel wrench
Windows, Power

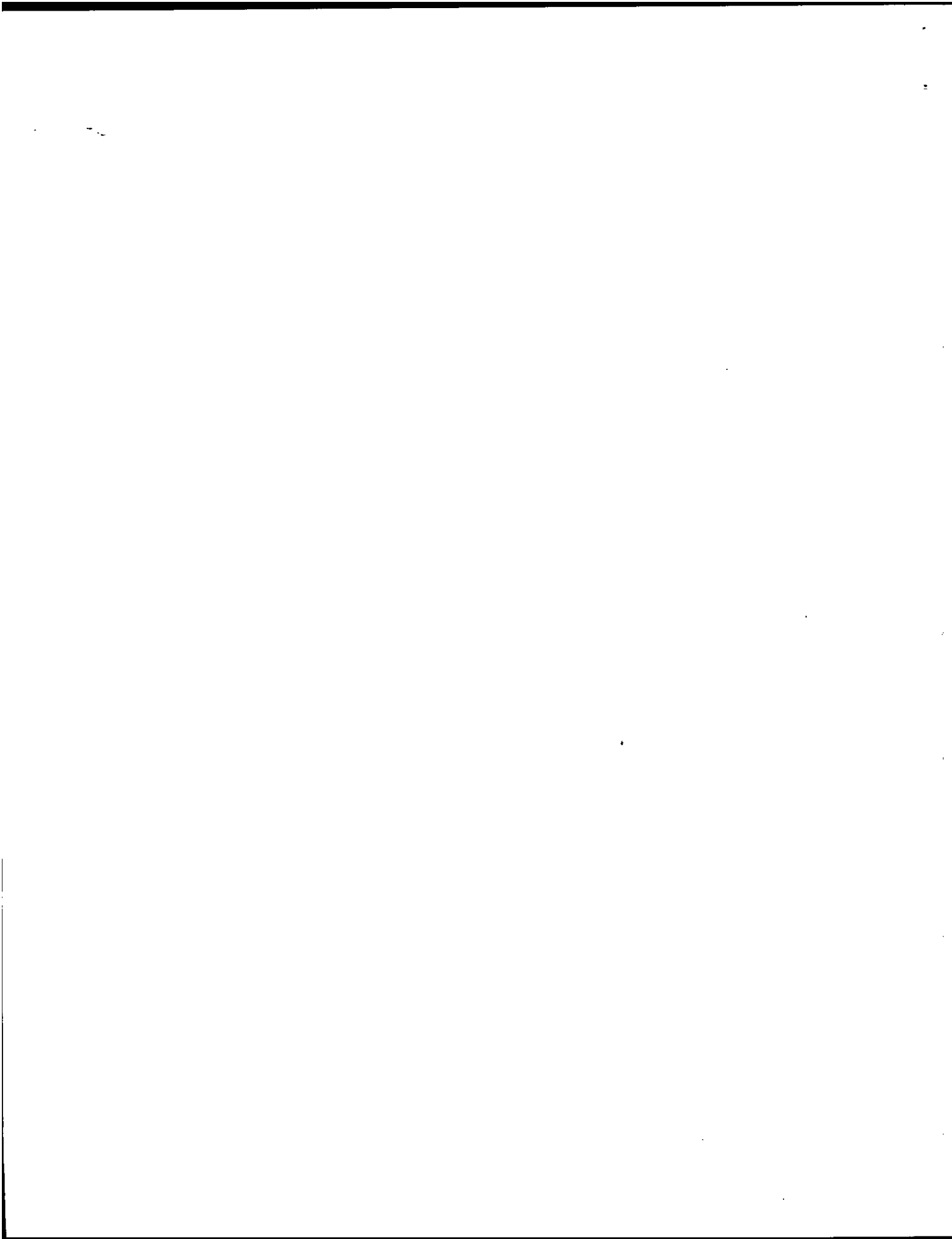

MODEL AND BODY

Description	Model No	Body
2-WHEEL-DRIVE	MODEL	
*15,913.00 (a) Tailgate 2-Door	CS10516	E55
*17,203.00 (a) Tailgate 4-Door	CS10506	E55

Description	Model No	Body
4-WHEEL-DRIVE	MODEL	
*17,709.00 (a) Tailgate 2-Door	CT10516	E55
*19,437.00 (a) Tailgate 4-Door	CT10506	E55

*Includes Destination & Handling Charges

(a) Reqs P16 Spare Wheel Carrier or PNV Carrier Not Desired

EMISSIONS (Must Order One) (Refer Emission Requirements Section)

FE9 Federal Emission Requirements

NG1 New York State Emission Requirements

YF5 California Emission Requirements

NB8 California Emission Override (Reqs FE9 Federal Emissions)

NC7 Federal Emission Override (Reqs NG1 New York State or YF5 California Emissions)

GVWR SELECTOR

GVW Rating (lbs)	GAWR (lbs)		Minimum Equipment Required For GVW Rating
	Front	Rear	
S10516			
4350	2200	2600	None
S10506			
4850	2300	2900	None
T10516			
4700	2400	2700	None
T10506			
5100	2500	2900	None

POWER TEAMS (Must Order Engine, Transmission and Rear Axle)

ENGINE	TRANSMISSION	AXLE	GVWR
	5-SP	3.08 3.42	
S10516/S10506			
LB4 V6 4.3 Liter EFI	MM5	(a) GU4 GU6	4350/4850
T10516/T10506			
LB4 V6 4.3 Liter EFI	MM5	-- GU6	4700/5100

(a) N/A G80 Locking Differential

ENHANCED POWER TEAMS (Must Order R8Y and Rear Axle)

ENGINE	TRANSMISSION	AXLE	GVWR
		3.08 3.42	
S10516/S10506			
V6 4.3 Liter CPI	AUTO	(a) GU4 GU6	4350/4850
T10516/T10506			
V6 4.3 Liter CPI	AUTO	-- GU6	4700/5100

(a) N/A G80 Locking Differential

THE LOWEST NUMERICAL AXLE RATIO HAS BEEN ENGINEERED TO COVER THE WIDEST RANGE OF APPLICATIONS AND OFFER THE BEST FUEL ECONOMY

REVISED: 08-23-93

1994 ORDER GUIDE

S/T BLAZER

PAGE 15

Prices Shown Are Manufacturer's Suggested Retail Prices (MSRP) At The Time Of Publication. These Prices Are To Be Used Only As An Aid To Inventory Management Since MSRP Figures Change Periodically. The Vehicle Price Schedule Is The Official Pricing Documentation Of Chevrolet Motor Division And Should Be Used In Discussing Vehicle Prices With Potential Buyers. The Model Prices Shown In The Order Guide Include The Destination Freight Charges.



CAPACITIES

S10516		
SPRINGS:		AXLES:
Front		Front
2200		2200
Rear		Rear
2600	Base	2900
S10506		
SPRINGS:		AXLES:
Front		Front
2300		2300
Rear		Rear
2900	Base	2900
T10516		
SPRINGS:		AXLES:
Front		Front
2400		2400
Rear		Rear
2700	Base	2900
T10506		
SPRINGS:		AXLES:
Front		Front
2500		2500
Rear		Rear
2900	Base	2900

AXLE, EMISSION, ENGINE, PEG, TIRE
AND TRANSMISSION MUST BE SPECIFIED.

No Deletions Allowed. Additional Options/Upgrades (Where Indicated)
May be Ordered from the Custom Ordering Option Listing.

		TAHOE LT	
		L	T
		B	1
2-DOOR			
Preferred Equipment Group 1			
*5545.00	S10516		
*5710.00	T10516		
**(-1300.00)	PEG 1 Savings		
	LT Trim	YC9	x
	Body-Standard	E55	x
	Air Conditioning	C60	x
	Convenience Group: Tilt Wheel and Cruise Control	ZQ3	x
	Driver Convenience: Electric Tailgate Release and Rear Window Defogger	ZM8	x
	Glass: Deep Tinted w/Light Tinted Rear Window (A)	AA3	x
	Radio: ETR AM/FM Stereo w/Seek-Scan, Cassette Tape and Clock (B)	UM6	x
	Window Wiper/Washer, Rear	C25	x

		TAHOE LT	
		L	T
		A	1
4-DOOR			
Preferred Equipment Group 1			
*5076.00	S10506		
*4910.00	T10506		
**(-1300.00)	PEG 1 Savings		
	LT Trim	YC9	x
	Body-Standard	E55	x
	Air Conditioning	C60	x
	Convenience Group: Tilt Wheel and Cruise Control	ZQ3	x
	Driver Convenience: Electric Tailgate Release and Rear Window Defogger	ZM8	x
	Glass: Deep Tinted w/Light Tinted Rear Window (A)	AA3	x
	Radio: ETR AM/FM Stereo w/Seek-Scan, Cassette Tape and Clock (B)	UM6	x
	Suspension: Soft Ride (T10506 Only)	FE1	x
	Window Wiper/Washer, Rear	C25	x

* The Preferred Equipment Group MSRP's Reflect the Base Group Equipment Prices. For any Options, Upgrades,
or Substitutions, Refer to the Vehicle Price Schedule for any Price Differential.
**PEG Savings Amount represents the savings for Preferred Equipment Groups.

Allowable Substitutions (Where Available):
(A) AA3: May substitute AJ1 Glass.
(B) UM6: May substitute UX1 or U1C Radio.



.

.

7.

.

.

.

.

.

.

.

.

.

.



ADDITIONAL OPTIONS

INCL. W/ P.E.G. OPTION			
N.C.		R8S	ACKNOWLEDGEMENTS:
N.C.		R8T	Multiple Order Numbers
N.C.	1	C60	Preliminary Invoice
115.00		ANL	AIR CONDITIONING
N.C.		GU4	AIR DAM WITH FOG LAMPS: (S10 Only)
N.C.		GU6	AXLES, REAR: (Refer Power Teams Chart for Availability)
252.00		G80	3.08 Ratio
N.C.		UA1	3.42 Ratio
56.00			Locking Differential
N.C.	1	E55	BATTERY: Heavy-Duty, 600 Cold Cranking Amps Delco Freedom (Incl w/V10 Cold Climate)
159.00		PNV	w/V10 Cold Climate
109.00		P16	w/o V10 Cold Climate
		V10	BODY CODE: Tailgate (Refer Model and Body Section)
		V08	CARRIERS: (Must Order PNV or P16 Carrier)
135.00			Outside Spare Tire Carrier Not Desired (Inside Mounting)
N.C.	1	ZQ3	Outside Spare Wheel and Tire Carrier (Incls Exterior Cover) (Recommended for OFN Tires)
N.C.	1	ZM8	COLD CLIMATE PACKAGE: (Incls UA1 Battery and Engine Block Heater)
N.C.		FE9	COOLING SYSTEM: Heavy-Duty (N/A R8Y Powertrain) (Incls radiator and engine oil coolers)
100.00		NG1	(Incl w/Z82 Trailering or Z72 Trailering)
100.00		YF5	w/Z82 or Z72
N.C.		NB8	w/o Z82 or Z72
N.C.		NC7	DRIVER CONVENIENCE:
1390.00		LB4	Tilt Wheel and Speed Control
(-230.00)		R8Y	Rear Window Convenience Package (Incls Electric Tailgate Release and Rear Window Defogger)
N.C.	1	AA3	EMISSIONS SYSTEMS: (REFER EMISSIONS REQUIREMENT TAB SECTION)
81.00		AJ1	Federal Emission Requirements
195.00		U52	New York State Emission Requirements
83.00		D48	w/R8Y
13.00		B74	w/o R8Y
N.C.		ZY8	California Emission Requirements
N.C.	1	UM6	w/R8Y
150.00		UX1	California Emission Override (Reqs FE9 Federal Emissions)
284.00		U1C	Federal Emission Override (Reqs NG1 New York State or YF5 California Emissions)
N.C.		A**8	ENGINES: (Refer Power Teams Chart for Availability)
(-650.00)		D**8	4.3 Liter EFI V6 (Reqs MM5 Transmission)
69.00		RYJ	ENHANCED POWERTRAIN: (Incls Enhanced 4.3L CPI V6 Engine, 4-Speed Electronically Controlled
75.00		ZM5	Automatic Transmission w/Overdrive and Eng and Trans Oil Coolers)
N.C.	1	FE1	ENHANCED POWERTRAIN SAVINGS: (Incl w/R8Y Enhanced Powertrain)
N.C.		QCF	GLASS:
N.C.		QFN	Deep Tinted w/Light Tinted Rear Window
109.00		Z72	Deep Tinted (Reqs ZM8 Driver Convenience Pkg)
300.00		Z82	INSTRUMENTATION, ELECTRONIC
210.00			MIRRORS: Exterior, Electric Remote
345.00			MOLDING: Wheel Opening Black
123.00		NP1	PAINT, EXTERIOR: Custom Two-Tone (Refer Trim Chart for Availability) (Incls Graduated Striping)
N.C.		MM5	RADIO EQUIPMENT:
257.00		AD5	Electronically Tuned AM/FM Stereo Radio w/Seek-Scan, Stereo Cassette Tape and Digital Clock
N.C.	1	C25	(Incls Premium Speakers)
			Electronically Tuned AM Stereo /FM Stereo Radio w/Seek-Scan, Stereo Cassette Tape with Search and Repeat,
			Graphic Equalizer and Digital Clock (Incls Premium Speakers)
			Electronically Tuned AM/FM Stereo Radio w/Seek-Scan Compact Disc Player and Digital Clock (Incls Premium
			Front and Rear Speakers)
			SEAT TRIM: (Refer Color and Trim Chart for Availability)
			Ultrasoft Leather Reclining High Back Buckets w/Power Lumbar Adjustment w/6-Way Power Driver Seat
			Deluxe Cloth Reclining High Back Buckets w/Power Lumbar Adjustment w/6-Way Power Driver Seat
			SECURITY SHADE: Cargo (Reqs P16 Outside Spare Tire Mount) (4-Door Only)
			SHIELD PACKAGE: (T10 Only) (Incls Transfer Case, Front Differential Skid Plates, Fuel Tank and Steering
			Linkage Shield)
			SUSPENSION PACKAGE: Soft Ride (T10506 Only) (Incls Bilstein Shock Absorbers) (Deletes Std Tow Hooks)
			TIRES: (W/L=White Lettered WOL=White Outlined Lettered) (Incls Full-Size Spare Tire) (Spare Wheel is Steel)
			All-Seasons Steel Belted Radial Ply (Front, Rear and Spare)
			P205/75R-15 W/L (S10 Only)
			P235/75R-15 WOL (T10 Only)
			TRAILERING PACKAGE: Light-Duty (N/A Z82 Trailering Equip) (w/LB4 Engine Incls V08 Cooling)
			(Incls 5-Lead Wiring Harness and Trailer Hitch)
			w/R8Y Enhanced Powertrain
			w/MM5 Transmission
			TRAILERING SPECIAL EQUIPMENT: Heavy-Duty (Refer Power Teams Chart for Availability)
			(w/LB4 Eng Reqs GU6 Rear Axle) (Incls 7-Lead Wiring Harness, Weight Distributing Hitch Platform
			and Heavy-Duty Flasher) (w/LB4 Engine Also Incls V08 Cooling)
			w/R8Y Enhanced Powertrain
			w/MM5 Transmission
			TRANSFER CASE: Electronic Shift (T10 Only)
			TRANSMISSIONS: 5-Speed Manual w/Overdrive (Refer Power Teams Chart for Availability)(N/A R8Y Enhanced Powertrain)
			WINDOW: Sliding Side (Reqs AA3 or AJ1 Deep Tinted Glass) (Available 2-Door Only)
			WINDOW WIPER/WASHER, REAR

S/T BLAZER LT INTERIOR AND EXTERIOR COLOR AVAILABILITY CHART WITH ZY8 TWO-TONE PAINT

PLEASE NOTE: Below are the interior trim color and exterior paint combinations recommended by Chevrolet. They are the only interior and exterior color combinations available.

TRIM LEVEL Seat Type	INTERIOR COLORS			
	Decor	Beige	Charcoal	Gray
TAHOE LT Ultrasoft Leather Reclining High Back Bucket Seats (Power)	YC9	AUU8	AJJ8	AQQ8
Deluxe Cloth Reclining High Back Bucket Seats (Power)		DUU8	DJJ8	DQQ8

EXTERIOR COLORS	Color Code 1	Color Code 2	RECOMMENDED INTERIOR TRIM COLORS			W/D85 Stripe Color
BLACK, MIDNIGHT/SILVER (Met)	19	17		x		Silver
BLACK, MIDNIGHT/KHAKI	19	52	x			Khaki
BLUE, ROYAL (Met)/SILVER (Met)	47	17		x		Silver
BLUE, ROYAL (Met)/KHAKI	47	52	x			Khaki
GARNET/SILVER (Met)	48	17		x		Silver
GARNET/KHAKI	48	52	x			Khaki
GRAY, STEEL (Met)/SILVER (Met)	90	17		x		Silver
GREEN, FOREST (Met)/SILVER (Met)	44	17		x		Silver
GREEN, FOREST (Met)/KHAKI	44	52	x			Khaki
RED, APPLE/SILVER (Met)	72	17		x		Silver
RED, APPLE/KHAKI	72	52	x			Khaki
WHITE, FROST/SILVER (Met)	12	17		x		Silver
WHITE, FROST/KHAKI	12	52	x			Khaki

S/T BLAZER LT Paint Applications

CUSTOM TWO-TONE PAINT - ZY8

(Incls Graduated Striping)

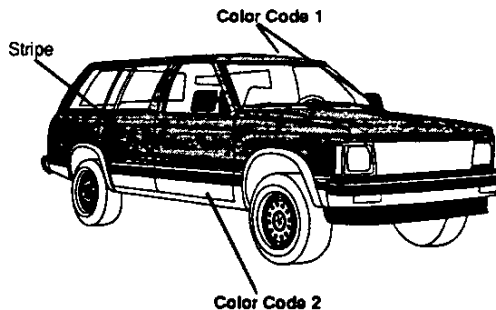

REVISED: 08-23-93

1994 ORDER GUIDE

S/T BLAZER

PAGE 19

Prices Shown Are Manufacturer's Suggested Retail Prices (MSRP) At The Time Of Publication. These Prices Are To Be Used Only As An Aid To Inventory Management Since MSRP Figures Change Periodically. The Vehicle Price Schedule Is The Official Pricing Documentation Of Chevrolet Motor Division And Should Be Used In Discussing Vehicle Prices With Potential Buyers. The Model Prices Shown In The Order Guide Include The Destination Freight Charges.



.

.

7



MODEL SELECTION SUMMARY

Use the chart below to choose the model that fits your customer's needs. Note that the Maximum Payload is based on curb weight. Also, the Maximum Gross Trailer Weight is based on vehicles that are properly equipped. See your 1994 Chevrolet Truck Order Guide for complete information.

SERIES	MODEL NUMBER/ BODY CODE/ OPTION CODE	PASSENGER CAPACITY (STD./OPT.)	STANDARD ENGINE/ TRANS.	OPTIONAL ENGINE/ TRANS.	GVWR (LBS.)	GAWR (LBS.) FRONT/ REAR	MAXIMUM PAYLOAD (LBS.) BASED ON CURB WT.	MAX. GROSS TRAILER WT./ TONGUE LOAD (LBS.) PROPERLY EQUIPPED
TWO-WHEEL DRIVE MODELS								
2-DOOR S-BLAZER	CS10516/ E55	2/4	4.3L V6/M5	— 4.3L V6(R8Y)/A4	4350	2200/2600	1129	4000/500 5500/650
4-DOOR S-BLAZER	CS10506/ E55	3/5/6	4.3L V6/M5	— 4.3L V6(R8Y)/A4	4850	2300/2900	1453	4000/500 5500/650
FOUR-WHEEL DRIVE MODELS								
2-DOOR S-BLAZER	CT10516/ E55	2/4	4.3L V6/M5	— 4.3L V6(R8Y)/A4	4700	2400/2700	1164	3500/450 5000/600
4-DOOR S-BLAZER	CT10506/ E55	6/5	4.3L V6/M5	— 4.3L V6(R8Y)/A4	5100	2500/2900	1324	3500/450 5000/600

POWERTRAINS

Chevrolet offers a variety of engines, transmissions and axle ratios for the S-Blazer. The following charts detail basic engine, transmission and axle specifications. See your 1994 Chevrolet Truck Order Guide for specific details.

ENGINES		
	4.3L V6	4.3L V6 (ENHANCED)
Order Code	LB4	R8Y (L35)
Availability	All models	All models
SAE Net Horsepower @ rpm	165 @ 4000	200 @ 4500
SAE Net Torque lbs-ft @ rpm	235 @ 2400	260 @ 3600
Fuel System	TBI	CPI
Clutch Size (in.)	11.02	—
Standard Battery Cold Cranking Amps @ 0° F	525	525
Standard Alternator Max. Cap. (Amps)	100	100

TRANSMISSIONS		
	MANUAL 5-SPEED W/OVERDRIVE (MY2)	ELECTRONIC AUTOMATIC 4-SPEED W/OD AND TORQUE CONVERTER CLUTCH (4L60-E) (M30)
Availability	All Models	All Models
Transmission Order Code	MM5	R8Y
Engine Application (Order Code)	4.3L V6 (LB4)	4.3L V6 (R8Y/L35)
Synchronized Speeds	1/2/3/4/5	—
Gear Ratios		
First	4.02	3.06
Second	2.32	1.63
Third	1.40	1.00
Fourth	1.00	0.70
Fifth	0.83	—
Reverse	3.74	2.29
Shaft Center Distance (mm)	85	—

S-BLAZER INTRODUCTION

S-BLAZER

The 1994 Chevrolet S-Blazer two-door is offered in three trim levels: "Standard," "Tahoe" and "Tahoe LT." The S-Blazer four-door is available in two trim levels: "Tahoe" and "Tahoe LT."

Some of the major changes for the S-Blazer for 1994 include:

- 4.3L V6 EFI and CPI Engine Enhancements
 - Underbody/Underhood Corrosion Protection Improvements
 - Side Door Guard Beams to comply with FMVSS 214
 - 60/40 Split Front Bench Seat now Standard on 4-Door Models
 - Improved Air Cleaner for 4.3L V6 EFI Engine
 - Intermittent Wipers now Standard Equipment
 - Optional Driver's Convenience Package that includes Tilt-Wheel™ and Cruise Control
 - Improved Alternator
 - Soft Ride Suspension Package now Available on T10506
-

INTERIOR EQUIPMENT

KEY: ■ = STANDARD, — = NOT INCLUDED		STANDARD (2-DOOR ONLY)	TAHOE (YC2)	TAHOE LT (YC9)
ARMRESTS	RH and LH padded integral with door panels.	■	■	■
CIGARETTE LIGHTER	Located on instrument panel, includes ashtray light.	■	■	■
COAT HOOKS	LH and RH, rear seat and in cargo area on 2-door models.	■	■	■
CONSOLE	Overhead with storage.	—	—	■
CONSOLE SEAT SEPARATOR	Requires front bucket seats. With manual transmission includes coin tray; with R8Y enhanced powertrain includes dual cupholder. Also includes a floor tray with an auxiliary power outlet.	—	■	■
CONVENIENCE NET	In cargo area on 2-door models only.	—	■	■
DOME LAMP	Front and rear with bright trim. Switches in RH and LH door jambs.	■	■	■
DOOR LOCKS	Power.	—	—	■
DOOR PANELS	Color-keyed plastic with map pockets and color-keyed housing in door latch release area. Color-keyed Deluxe Cloth upper inserts, carpeted lower insert and map pockets with coin holder in LH door. Color-keyed ultra-soft leather upper inserts, carpeted lower insert and map pocket with coin holder in LH door.	■	—	—
DOOR SILL PLATE	Black.	■	■	■
DOORS	Side door guard beams added for extra protection and strength.	■	■	■
FLOOR COVERING	Color-keyed full floor carpeting. Color-keyed full floor carpeting with carpeted front and rear floor mats.	■	—	—
HEADLAMP WARNING BUZZER	Headlamps on.	■	■	■
HEADLINER	Full-foam with color-keyed cloth cover. Includes grab handles over all outboard passenger seating positions.	■	■	■
HEATER	Deluxe with side window defoggers.	■	■	■
INSTRUMENTS	Warning lights for seat belt, parking brake, direction/hazard signals and high-beam. Gauge packages includes voltmeter, oil pressure and engine temperature gauge, trip odometer and speedometer.	■	■	■
INSULATION	Provided on dash panel, doors, roof and floor.	■	■	■
KEYLESS ENTRY	Remote.	—	—	■
KICK PANELS	Color-keyed cowl kick, carpeted lower rear quarter and endgate panels.	—	■	■
MIRRORS	10-inch rearview. 10-inch rearview w/dual reading lamps and illuminated entry feature.	■	—	—
POWER OUTLET	Located on floor console.	—	■	■
RADIO	ETR AM radio, with two 4" x 6" front dash speakers, digital clock and fixed mast antenna.	■	■	■
SEATS	2-door: custom vinyl reclining high-back front buckets with folding backs. RH includes easy-entry feature. 4-door: deluxe cloth three-passenger 60/40 reclining and folding front bench on 4x2 and 4x4 and three-passenger folding rear bench on 4x4 only. 2-door: six-way power driver's bucket seat, passenger bucket seat, ultra-soft leather trim. RH includes easy-entry feature. Power lumbar adjustment on driver's and passenger's seat. 4-door: six-way power driver's bucket seat, passenger bucket seat, and three passenger folding rear bench, ultra-soft leather trim. Power lumbar adjustment on driver's and passenger's seat.	■	■	—
SPARE TIRE AND WHEEL	Full-size spare tire and steel wheel with cover located at left rear.	■	■	■
STEERING WHEEL	Four-spoke, deluxe black urethane. Leather wrapped.	—	—	■
STORAGE BOX	RH side of instrument panel with door activated light.	■	■	■
SUNSHADE	LH and RH color-keyed, padded. Dual, with extenders LH and RH lighted visor mirrors including convenience straps.	■	—	—
TOOLS	Mechanical jack and wheel wrench with cover located at left rear.	■	■	■
WINDOWS	Solar-Ray light-tinted glass. Power windows.	■	■	■
WINDSHIELD WIPERS	Intermittent.	■	■	■

S-BLAZER

AXLES						
	REAR AXLE				FRONT AXLE	
Availability	2-Door Models		4-Door Models		All 4x4 Models	
Make	GM		GM		GM	
Capacity (lbs.)	2900		2900		2400/2500	
Pinion and Ring Gear Type	Hypoid		Hypoid		Hypoid	
Engine Availability	4.3L V6 (LB4)/4.3L V6 (R8Y/L35)		4.3L V6 (LB4)/4.3L V6 (R8Y/L35)		4.3L V6 (LB4)/4.3L V6 (R8Y/L35)	
Axle Ratio Code	GU4	GU6	GU4	GU6	GU4	GU6
Ratio	3.08	3.42	3.08	3.42	3.08	3.42
Pinion Teeth	13	12	13	12	13	12
Ring Gear Teeth	40	41	40	41	40	41
Ring Gear Diameter (in.)	7.62	7.62	7.62	7.62	7.25	7.25

Note: Axle Ratio availability depends on model, powertrain and emissions selected. See your 1994 Chevrolet Truck Order Guide for details.

TRIM LEVELS

Chevrolet offers S-Blazer 2-Door in three trim levels: "Standard," "Tahoe" and "Tahoe LT." The S-Blazer 4-Door is offered in two trim levels: "Tahoe" and "Tahoe LT." The following chart details major standard features. See your 1994 Chevrolet Truck Order Guide for details.

CHASSIS EQUIPMENT		STANDARD (2-DOOR ONLY)	TAHOE (YC2)	TAHOE LT (YC9)
KEY: ■ = STANDARD, — = NOT INCLUDED				
BRAKES	Power Assisted; front disc, rear drum. Includes four-wheel anti-lock system.	■	■	■
FRAME	All-welded ladder-type, channel design and boxed front-end section.	■	■	■
FUEL TANK	20.0 Gallon (approx.) capacity.	■	■	■
REAR AXLE	Hypoid semi-floating.	■	■	■
SHOCK ABSORBERS	S10516: 25 mm, front and rear. S10506, T10506, T10516: 32 mm, front and rear.	■	■	■
STABILIZER BAR	4x2: Front 1.14 inch; 4x4: Front 1.26 inch.	■	■	■
STEERING	Integral power.	■	■	■
SUSPENSION, FRONT	4x2: Independent with computer-selected coil springs. 4x4: Independent with computer-selected torsion springs.	■	■	■
SUSPENSION, REAR	Semi-elliptic two-stage multi-leaf springs.	■	■	■
TOW HOOKS	Two front-mounted on 4x4 only.	■	■	■

¹ Not available on 4-Door Models w/ YC9 package.

EXTERIOR EQUIPMENT		STANDARD (2-DOOR ONLY)	TAHOE (YC2)	TAHOE LT (YC9)
AIR DAM	Black.	■	■	■
BUMPERS	Color-keyed to lower body color with black rub strips and bright inserts. Chromed with black rub strips and bright inserts.	■	—	■
GRILLE	Black molded plastic with matching headlamp and side marker lamp bezels. Chrome and dark gray molded plastic with headlamp and side marker lamp bezels.	■	—	—
HEADLAMPS	Single rectangular halogen.	■	■	■
HORN	Dual horns, low-and high-note.	■	■	■
INSULATION	Hood insulation and cowl-to-fender seals.	■	■	■
LAMP	Engine compartment and center high-mounted stop lamp.	■	■	■
LUGGAGE RACK	Black.	—	—	■
MIRRORS	RH and LH below-eye-line type, black. Head size 6.0" x 7.0".	■	■	■
MOLDING	Black body side with bright insert and bright wheel opening lip.	—	■	■
PAINT	Solid (ZY1). Two-tone (ZY8) with stripe.	■	■	—
TIRES	P205/75R15BW all-season steel-belted radials. 4x2: P205/75R15/WL all-season steel-belted radials. 4x4: P235/75R15/WOL all-season steel-belted radials.	■	■	—
TRIM	Black taillight trim.	■	■	■
WHEELS	15.0" x 6.0" steel painted silver. Includes bright metal hub covers on 4x2 and black hub covers on 4x4. 15.0" x 7.0" steel Rally with black center insert and gold "bow tie," black rims with silver coined surfaces and trim rings on 4x2. 15.0" x 6.0" steel, painted silver w/trim rings on 4x4. 15.0" x 7.0" cast aluminum wheels (4x2). 15.0" x 7.0" special aluminum wheels (4x4).	■	—	—
		—	■	—
		—	—	■
		—	—	■
		—	—	■

S-BLAZER

PREFERRED EQUIPMENT GROUPS

Preferred Equipment Groups (PEGs) are convenient option packages that can save your customers money. They would pay appreciably more by buying all the options in a Preferred Equipment Group as individual options. (Savings based on a comparison of Manufacturer's Suggested Retail Price of option packages versus MSRP of individual options purchased separately). See your 1994 Chevrolet Truck Order Guide and Vehicle Price Schedule for specific information and prices.

OPTIONS

These options can be ordered individually in addition to the Preferred Equipment Groups if not already included. See your 1994 Chevrolet Truck Order Guide for specific availability and restrictions. The Option Code is listed in **bold type**.

Air Conditioning **C60**
 Air Dam w/Fog Lamps (4x2 only) **ANL**
 Axles, Rear
 3.08 **GU4**
 3.42 **GU6**
 Axle, Rear Locking Differential **G80**
 Battery, Heavy-Duty (600 CCA, included w/V10 Cold Climate Package) **UA1**
 Cargo Area Security Shade (4-door only, requires P16 spare tire mount) **RYJ**
 Carrier, Luggage (black) **V54**
 Carrier, Outside Spare Tire (mounted outside of rear endgate, includes exterior cover) **P16**
 Carrier, Outside Spare Tire Carrier Not Desired **PNV**
 Cold Climate Package (includes Heavy-Duty Battery, Engine Block Heater, enhanced anti-freeze protection) **V10**
 Console, (Requires Hi-Back Bucket Seats) **D55**
 Console, Overhead (requires bucket seats) **DK6**
 Convenience Package, Driver's (includes Tilt-Wheel™ Steering and Cruise Control) **ZQ3**
 Convenience Package, Operating (includes Power Door Locks and Power Windows) **ZQ2**
 Convenience Package, Rear Window (includes Rear Defogger and Power Tailgate Release) **ZM8**
 Cooling System, Heavy Duty (LB4 only) **V08**
 Emission Systems:
 Federal **FE9**
 New York **NG1**
 California **YF5**
 Federal Override **NC7**
 California/New York Override **NB8**
 Engine:
 4.3L TBI V6 (requires Manual Transmission) **LB4**
 4.3L CPI V6 (requires Automatic Transmission) **R8Y/L35**

Floor Covering, Rubber (full floor, charcoal, replaces carpeting 2-door only) **BG9**
 Floor Covering, Removable Carpeted Mats (color-keyed):
 Front **B32**
 Rear **B33**
 Glass, Deep-Tinted **AJ1**
 Glass, Deep-Tinted, with light-tinted rear window **AA3**
 Instrumentation, Electronic (electronic readout voltmeter, temperature, oil pressure, fuel, speedometer, tachometer) **U52**
 Mirrors, Exterior Electric Remote (Mirror head: 4.0" x 6.5") **D48**
 Moldings, Wheel Opening (Black) **B74**
 Paint, Exterior
 Solid **ZY1**
 Special Two-Tone **ZY3**
 Custom Two-Tone **ZY8**
 Powertrain, Enhanced (includes enhanced 4.3L CPI V6, Electronic 4-Speed Automatic with Overdrive and Torque Converter Clutch transmission and Engine and Transmission oil coolers) **R8Y**
 Radio Equipment
 Radio Delete **UL5**
 ETR AM/FM Stereo Radio w/Seek-Scan, Stereo Cassette/Digital Clock **UM6**
 ETR AM/FM Stereo Radio w/Seek-Scan/Digital Clock **UM7**
 ETR AM/FM Stereo Radio w/Seek-Scan/Digital Cassette with Search/Repeat, Graphic Equalizer/Digital Clock **UX1**
 ETR AM/FM Stereo Radio w/Seek-Scan, Compact Disc Player, Digital Clock and Premium Speakers **U1C**
 Remote Keyless Entry (requires D55 console ZQ2 operating package and ZM8 rear window package) **AX3**
 Seat, Rear Folding Bench **AM7**
 Seat, Rear Not Desired **YG4**

Shield Package (4x4 only, includes transfer case and front differential skid plates, fuel tank and steering linkage shields) **ZM5**
 Shock Absorbers, Heavy-Duty (32 mm front and rear) **F51**
 Springs (Torsion Bars), Front Heavy-Duty (4x4 only includes Heavy-Duty Shock Absorbers F51) . **F60**
 Suspension Package
 Off-Road (includes gas shocks, larger torsion bars, jounce bumper and stabilizer bar on 2-door, 4x4 only) **ZM6**
 Soft Ride (includes Bilstein Shocks, deletes standard tow hooks and requires QFN tires, T10506 only) **FE1**
 Trailing Package, (includes five-lead wiring harness, heavy-duty flasher, dead weight trailer hitch) **Z72**
 Trailing Special Equipment, Heavy-Duty (includes seven-lead wiring harness, heavy-duty flasher, weight distribution platform hitch and V08 heavy duty cooling with LB4 engine) **Z82**
 Transfer Case, Electronic Shift (instrument panel-mounted switch, eliminates shift lever controls and includes a console) **NP1**
 Transmissions:
 5-speed Manual with Overdrive (N/A R8Y) **MM5**
 Electronic Automatic 4-speed w/Overdrive (N/A LB4) **R8Y**
 Trim, Blackout Package (includes 80° black grille, body color bumpers with rub strips and B74 black wheel lip moldings) (Reqs. YC2) **ZQ9**
 Wheels, Trim (trim rings) **P06**
 Wheels, Special Aluminum (4x4) **5P2**
 Wheels, Cast Aluminum (4x2) **PA3**
 Wheels, Rally (steel w/Trim Rings) (4x2) **ZJ7**
 Window Wiper/Washer, Rear **C25**
 Windows, Sliding Side (2-door only) .. **AD5**

TIRES

KEY: ALS = ALL-SEASON SBR = STEEL-BELTED RADIAL PLY BW = BLACKWALL WW = WHITEWALL WL = WHITE LETTERED HWY = HIGHWAY BL = BLACK LETTERED OOR = ON-OFF ROAD WOL = WHITE OUTLINE LETTERED

TIRE DESCRIPTION		ORDERING CODE
P205/75R15	ALS/SBR/BW	QCE
P205/75R15	ALS/SBR/WL	QCF
P205/75R15	OOR/SBR/WOL	QJL
P235/75R15	OOR/SBR/WOL	QEB
P235/75R15	ALS/SBR/WL	QFN



7

2

1

1

1

1



S 10006 Models

S10506		107.0" Wheelbase					Frame Heights at Base Model Curb Weight				Frame Heights and Angular Dimensions are shown at Maximum GAWR Front and Rear												
GVW/Tire	Base Model Curb Weight			GAWR		HF	HM	HR	HE	HF	HM	HR	HE	A	B	C	D	E	F	G	H	J	K
	Frnt	Rr	Ttl	Frnt	Rr																		
4850 P205/75R15	1927	1656	3583	2300	2900	16.8	15.3	24.3		15.9	13.6	21.6		16	33	22		25	28	26	16	15	

S10516		100.5" Wheelbase					Frame Heights at Base Model Curb Weight				Frame Heights and Angular Dimensions are shown at Maximum GAWR Front and Rear												
GVW/Tire	Base Model Curb Weight			GAWR		HF	HM	HR	HE	HF	HM	HR	HE	A	B	C	D	E	F	G	H	J	K
	Frnt	Rr	Ttl	Frnt	Rr																		
4350 P205/75R15	1781	1660	3441	2200	2600	18.8	16.4	24.2		17.7	14.9	22.2		19	36	26		25	29	26	16	15	

T 10006 Models

T10506		107.0" Wheelbase					Frame Heights at Base Model Curb Weight				Frame Heights and Angular Dimensions are shown at Maximum GAWR Front and Rear												
GVW/Tire	Base Model Curb Weight			GAWR		HF	HM	HR	HE	HF	HM	HR	HE	A	B	C	D	E	F	G	H	J	K
	Frnt	Rr	Ttl	Frnt	Rr																		
5100 P205/75R15	2212	1773	3985	2500	2900	18.0	15.9	24.1	22.4	17.0	14.4	22.0	20.0	16	27	34	25		24	27	25	15	14

T10516		100.5" Wheelbase					Frame Heights at Base Model Curb Weight				Frame Heights and Angular Dimensions are shown at Maximum GAWR Front and Rear												
GVW/Tire	Base Model Curb Weight			GAWR		HF	HM	HR	HE	HF	HM	HR	HE	A	B	C	D	E	F	G	H	J	K
	Frnt	Rr	Ttl	Frnt	Rr																		
4700 P205/75R15	2051	1730	3781	2400	2700	18.0	15.9	24.1	22.4	17.0	14.4	22.0	20.0	19	28	35	26		25	29	26	16	15

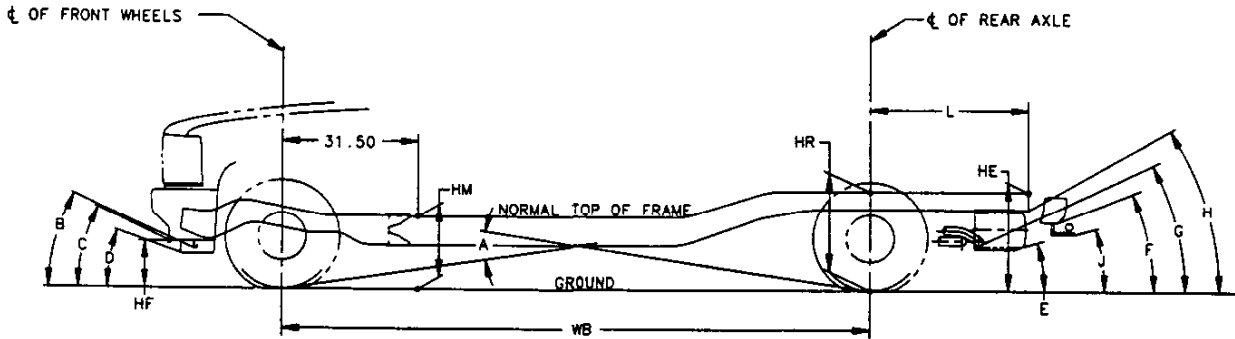

FRAME HEIGHTS AND LENGTHS

- L Centerline of axle to end of frame
- HF Bottom of bumper to ground
- HM Inside top of frame to ground
- HR Top of frame to ground at centerline of rear axle
- HE Top of frame to ground

ANGLE(S)

- A Ramp breakover

ANGLE(S) (APPROACH)

- B Tow hooks
- C Front bumper
- D Spoiler

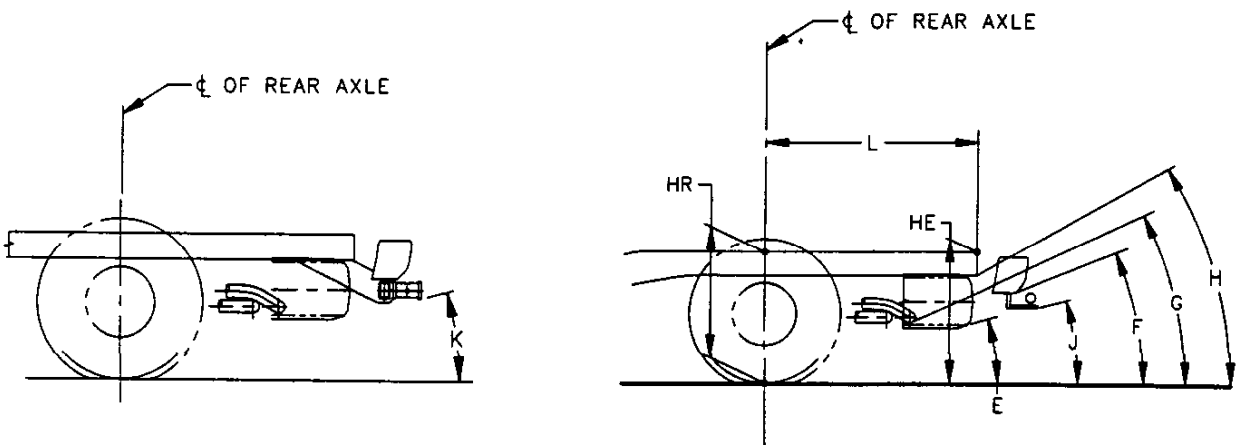

ANGLE(S) (DEPARTURE)

- E Spare tire
- F Rear bumper
- G Exhaust
- H Chassis
- J Hitch
- K Platform hitch

Note: All weights are in pounds and all dimensions are in inches.