

# TAHOE

The 1995 Tahoe (formerly Blazer) is available in three trim levels: "Standard" and a choice of two uplevel trims: "LS" and "LT".

Changes on the Tahoe for 1995 include:

- New "Tahoe" name
- 5.7L V8 Engine enhancements
- Standard air conditioning with LS/LT Decor
- Standard Driver's Side Air bag
- New 7-Lead Wiring Harness for trailering
- Standard Driver's Convenience Group: Speed Control and Tilt Steering, and Power Windows and Door Locks with LS/LT Decor
- New Instrument Panel design includes dual cupholders located in the dash and standard tachometer
- Standard Backlit Power Window and Door Lock Switches
- Standard Rear Window Wiper/Washer and Defogger with LS/LT Decor with E55 Body
- Standard ETR AM/FM Stereo Radio with Seek-Scan with Automatic Tone Control, Digital Clock, Cassette Deck, Theft Lock and Speed Compensated Volume on LS/LT Decor
- Optional ETR AM/FM Stereo Radio with Seek-Scan with Automatic Tone Control, Digital Clock, Cassette Deck and/or Compact Disc with Theft Lock and Speed Compensated Volume
- New 60/40 Cloth Reclining Front Split Bench Seats with center armrest and head restraints includes 3 passenger rear bench seat with LS/LT Decor
- Standard Electric Below-Eye-Line Outside Rearview Mirrors with LS/LT Decor
- New trim level badging
- Standard Luggage Carrier with LS/LT Decor
- 2-Sided Key for simplified entry
- Smoother shifting 4L80-E Automatic Transmission
- Standard Brake/Transmission Shift Interlock
- New Rear Shocks Location to improve ride control
- Optional Remote Keyless Entry feature
- Re-designed center console with Reclining High Back Bucket Seats
- Optional Leather Seats
- New exterior colors
- New interior colors
- New Rear Cargo Doors (ZW9)
- New right hand Assist Handle

equipped. See your 1995 Chevrolet Truck Order Guide for specific details.

SERIES	MODEL NUMBER/BODY CODE/OPTION CODE	PASSENGER CAPACITY (STD./OPT.)	STANDARD ENGINE/TRANS.	OPTIONAL ENGINE/TRANS.	GVWR (LB)	GAWR FRONT/REAR	MAXIMUM PAYLOAD (LB) BASED ON CURB WT.	MAX. GROSS TRAILER WT./TONGUE LOAD (LB) PROPERLY EQUIPPED
<b>K1500 TAHOE</b>	CK10516/ZW9	5/6	5.7L V8/M5	5.7L V8/A4 6.5L V8/A4	6250 6450	3327/3750 3427/3750		6500/800 7000/850

**FOUR-WHEEL DRIVE MODELS**

<sup>T</sup>Turbo

**POWERTRAINS**

Chevrolet offers a variety of engines and transmissions and axle ratios for the Tahoe. The following charts detail basic engine, transmission and axle specifications. See your 1995 Chevrolet Truck Order Guide for specific details.

**ENGINES**

	5.7L V8	6.5L V8 TURBO DIESEL
Engine Order Code	L05	L56
SAE Net Horsepower @ rpm	300 @ 4000	180 @ 3400
SAE Net Torque lb ft @ rpm	300 @ 2200	360 @ 1700
Fuel System	EFI	TIDI
Clutch Size (in.)	12	12
Standard Battery Cold Cranking Amps @ 0° F	600	2 @ 600 each
Standard Alternator Max. Cap. (Amps)	100	100

**TRANSMISSIONS**

	MANUAL 5-SPEED WITH OVERDRIVE (5LM60)	ELECTRONIC AUTOMATIC 4-SPEED WITH OVERDRIVE AND TORQUE CONVERTER CLUTCH (4L60-E)	ELECTRONICALLY-CONTROLLED AUTOMATIC 4-SPEED W/OVERDRIVE TORQUE CONVERTER CLUTCH HD (4L80-E)
Transmission Order Code	MG5	M30	MT1
Engine Application (Order Code)	5.7L V8 (L05)	5.7L V8 (L05)	6.5L V8 Turbo Diesel (L56)
Synchronized Speeds	1/2/3/4/5	—	—
Gear Ratios	4.02 2.32 1.40 1.00 0.73 3.55	3.06 1.63 1.00 0.70 — 2.29	2.48 1.48 1.00 0.75 — 2.08
Power Take-Off	No	No	No

**AXLES**

	REAR AXLE	FRONT AXLE
Make	GM	GM
Capacity (lb)	3750	3925
Pinion and Ring Gear Type	Hypoid	Hypoid
Engine Availability	5.7L V8 (L05)/6.5L V8 Turbo Diesel (L56)	5.7L V8 (L05)/6.5L V8 Turbo Diesel (L56)
Axle Ratio Code	GU6	GU6
Ratio	3.42 3.73 4.10	3.42 3.73 4.10

## CHASSIS EQUIPMENT

KEY: ■ = STANDARD, — = NOT INCLUDED

	STANDARD	S/LT (YE9)
<b>BRAKES</b>	Power-assisted; front disc, rear drum with four-wheel antilock.	■
<b>EXHAUST</b>	Single.	■
<b>FRAME</b>	All-welded ladder-type, channel design and boxed front-end section. Section Modulus: 4.29 cu in.	■
<b>FUEL TANK</b>	30.0 gallon (approx.) capacity.	■
<b>REAR AXLE</b>	Hypoid semi-floating.	■
<b>SHOCK ABSORBERS</b>	Front: 32 mm; Rear 32 mm.	■
<b>STABILIZER BAR</b>	1.18 inch.	■
<b>STEERING</b>	Integral Power.	■
<b>SUSPENSION, FRONT</b>	Independent w/torsion bars.	■
<b>SUSPENSION, REAR</b>	Semi-elliptic two-stage multi-leaf springs.	■
<b>TOW HOOKS</b>	Two front.	■

## EXTERIOR EQUIPMENT

<b>AIR DAM</b>	Black.	■
<b>BUMPER, FRONT</b>	Bright appearance with black rub strip.	■
<b>BUMPER, REAR</b>	Bright appearance with black rub strip and bright trim.	—
<b>DOORS, REAR</b>	Bright appearance with black rub strip and step pad.	■
<b>GLASS</b>	Panel type.	■
<b>GRILLE</b>	Solar-Ray™ Tinted glass. Deep tint glass included on YE9.	■
<b>HEADLAMPS</b>	Molded plastic painted medium argent with dark argent air-intake areas. Deluxe front appearance package with bright grille and trim, with dark argent air-intake areas.	—
<b>HORN</b>	Single rectangular halogen.	■
<b>INSULATION</b>	Composite halogen.	—
<b>LAMPS</b>	Dual low- and high-note.	■
<b>LUGGAGE CARRIER</b>	Hood and cab-to-fender.	—
<b>MIRRORS</b>	Center high-mounted stop lamp.	■
<b>MOLDINGS</b>	Black.	—
<b>TIRES</b>	RH and LH below-eye-line type, painted black with adjustable heads. Head size 8.5" x 5.0".	■
<b>WHEELS</b>	RH and LH electric below-eye-line, outside rearview, black. Headsize 8.5" x 5.0".	—
<b>WIRING</b>	Black body-side with bright trim (and bright wheel opening). Five, LT245/75R16C all-season steel-belted radial blackwall. Five, argent painted 16.0" x 6.5" steel wheels with black hub ornament. Four, aluminum 16.0" x 6.5" wheels with steel spare wheel. Seven-lead wiring harness for trailering purposes.	■

## INTERIOR EQUIPMENT

<b>AIR BAG</b>	Driver's side.	■
<b>AIR CONDITIONING</b>	Front.	—
<b>ARMRESTS</b>	RH and LH padded integral with door panels.	■
<b>ASSIST HANDLES</b>	Right front, left rear, right rear.	■
<b>CIGARETTE LIGHTER</b>	Located on instrument panel inside ashtray bin. Includes ashtray light and two auxiliary power outlets.	■
<b>CUPHOLDERS</b>	Two located in the dash.	■
<b>DOOR PANELS</b>	Color-keyed grained molded plastic. Soft vinyl color-keyed door panel with cloth inserts, armrest and map pockets with carpet trim. NOTE: Scotchgard™ protection on all cloth seats and door trim panels.	—
<b>DOOR PILLAR AND ROOF SIDE PANELS</b>	Color-keyed.	■
<b>DOOR SILL PLATE</b>	Color-keyed.	■
<b>DOORS</b>	Side door guard beams added for extra protection and strength.	■
<b>DRIVER'S CONVENIENCE GROUP</b>	Speed Control and Tilt Steering. Power windows and door locks.	■
<b>FLOOR COVERING</b>	Black embossed two-piece vinyl mat. Color-keyed carpet with Scotchgard™ and removable color-keyed vinyl floor mats.	—

<b>BUZZER</b>	Heavy-duty and defogger. Deluxe with windshield and front side defoggers. Rear defogger.	■	■
<b>HEATER</b>	Provided on dash panel, cowl top and sides, headliner and doors. Additional insulation on headliner and side panel.	■	■
<b>INSULATION</b>	Front and rear dome lamps with switches in RH and LH door jambs. Front and rear map lamps, glove box and underhood lamps.	■	■
<b>LIGHTING, INTERIOR</b>	10-inch rearview.	■	■
<b>MIRRORS</b>	ETR AM/FM stereo radio with seek-scan and digital clock. Includes two 6" diameter front door speakers and two 4" x 10" rear speakers mounted in the rear headliner (4 speakers in all).	■	■
<b>RADIOS</b>	ETR AM/FM stereo radio with seek-scan with automatic tone control, digital clock, cassette deck, theft lock and speed-compensated volume. Includes two front 6" diameter door speakers, two 6" tweeters located in power switch pad forward of armrest, and two rear 4" x 10" speakers mounted in the rear headliner (6 speakers in all).	■	■
<b>REAR QUARTER TRIM PANELS</b>	Black fabric. Color-keyed, carpeted with cupholder, storage space and ashtrays. NOTE: Scotchgard protection on all cloth seats and trim panels.	■	■
<b>RELEASE, ELECTRIC LIFT GLASS</b>	Located on instrument panel (w/E55 body).	■	■
<b>SEATS</b>	Two vinyl reclining low-back buckets with head restraints and easy-entry feature with memory and 3-passenger folding rear bench seat. 3-passenger cloth 60/40 reclining front split bench seat with center armrest. Easy-entry feature with memory, 3-passenger folding rear bench with head restraints. NOTE: Scotchgard protection on all cloth seats.	■	■
<b>SPARE TIRE CARRIER</b>	Located inside on LH rear panel. Includes color-keyed carpeted wheel cover.	■	■
<b>SPARE TIRE/WHEEL</b>	Full size, match other wheels and tires, mounted inside (YE9 includes steel spare and not aluminum).	■	■
<b>STEERING WHEEL</b>	Simulated leather. Leather.	■	■
<b>SUNSHADES</b>	Color-keyed cloth RH and LH, padded with visor mirror on RH unit. Color-keyed RH and LH padded with cloth covering, extenders and illuminated visor mirrors. Storage strap on LH unit.	■	■
<b>TOOLS</b>	Mechanical jack and wheel wrench.	■	■
<b>WINDSHIELD WIPERS</b>	Intermittent. Rear wiper/washer (with YE9 and E55).	■	■

## PREFERRED EQUIPMENT GROUPS

Preferred Equipment Groups (PEGs) are convenient option packages that can save your customers money. They would pay appreciably more by buying all the options in a Preferred Equipment Group as individual options. (Savings based on a comparison of Manufacturer's Suggested Retail Price of option packages vs. MSRP of individual options purchased separately). See your 1995 Chevrolet Truck Order Guide and Vehicle Price Schedule for specific information and prices.

## OPTIONS

These options can be ordered individually in addition to the Preferred Equipment Groups if not already included. See your 1995 Chevrolet Truck Order Guide for specific availability and restrictions. The Option Code is listed in **bold type**.

Air Conditioning .....	<b>C60</b>	Cooling: Heavy Duty Transmission .....	<b>KNP</b>	Mirrors, Camper Type (LH and RH stainless steel) .....	<b>DF2</b>
Axles, Rear: 3.42 .....	<b>GU6</b>	Defogger, Rear Window (Reqs ZW9) .....	<b>C49</b>	Moldings, Wheel Opening Flare (front and rear) .....	<b>B71</b>
3.73 .....	<b>GT4</b>	Emissions: Federal .....	<b>FE9</b>	Paint, Exterior: Solid .....	<b>ZY1</b>
Axle, Rear Locking Differential .....	<b>G80</b>	California .....	<b>FE5</b>	Conventional Two-Tone (Reqs YE9) .....	<b>ZY2</b>
Body, Tailgate (drop gate tailgate with lift-glass and electric tailgate release) .....	<b>E55</b>	Massachusetts .....	<b>NG1</b>	Radio Equipment: Radio Delete (N/A YE9) .....	<b>UL5</b>
Chassis Equipment Off-Road Package (includes front and rear 46 mm high-pressure gas shocks and NZZ Shielda Package) .....	<b>Z71</b>	Federal Emissions Override .....	<b>NC7</b>	ETR AM/FM Stereo Radio w/Seek-Scan, Stereo Cassette, Digital Clock .....	<b>UM6</b>
Cold Climate Package (includes Engine		Cal. Mass Emissions Override .....	<b>NB8</b>	Scan with Automatic Tone Control	
		Engine: 5.7L V8 .....	<b>L05</b>		
		6.5L V8 Turbo Diesel .....	<b>L56</b>		
		Glass, Solar-Ray® Deep-Tinted Rear .....	<b>AJ1</b>		
		GMWR Ratings:			

ETR AM/FM Stereo Radio with Seek-Scan with Automatic Tone Control, Compact Disc Player, Digital Clock, Theft Lock and Speed-Compensated Volume (with LS and LT Decor includes an enhanced performance speaker system) ..... **UNO**

ETR AM/FM Stereo Radio with Seek-Scan with Automatic Tone Control, Compact Disc Player, Cassette Deck, Digital Clock, Theft Lock and Speed-Compensated Volume (with LS and LT Decor includes an enhanced performance speaker system) ..... **UPO**

Rear Window Equipment:  
 Vibration Dampener System with Defogger  
 Measures 558 cc/0.0001 ..... **U36**

Seat:  
 Seat Adjuster, Power (driver's side only) .. **AG9**  
 Low Back Reclining Bucket Seats ..... **A50**  
 60/40 Reclining Split-Bench Seat ..... **AE7**  
 Reclining high back bucket seats (includes center and roof console) ..... **A95**  
 Skid Plate Package (includes shield plates for engine, front differential, transfer case and fuel tank) ..... **NZZ**

Sport Appearance Package (includes Conventional Two-Tone Paint and Wheel Flare Moldings) ..... **BYP**  
 Springs (Torsion Bars), Front Heavy-Duty ... **F60**  
 Trailing Package, Heavy-Duty (includes hitch platform) ..... **Z82**

Transmissions:  
 5-speed Manual with Overdrive ..... **MG5**  
 Electronic 4-speed Auto. w/OD ..... **M30**  
 Electronically Controlled 4-speed Automatic w/Overdrive ..... **MT1**  
 Wheels, Rally Trim (N/A YE9) ..... **P06**  
 Wheels, Cast Aluminum ..... **PF4**

<b>TIRES</b>	
<b>KEY: ALS = ALL-SEASON SBR = STEEL-BELTED RADIAL PLY BW = BLACKWALL WOL = WHITE OUTLINE LETTERED OOR = ON-OFF ROAD</b>	
TIRE DESCRIPTION	ORDER CODE
LT245/75R16C ALS/SBR/BW	QIT
LT245/75R16C OOR/SBR/BW	QBN
LT265/75R16C OOR/SBR/BW	QIX
LT265/75R16C OOR/SBR/WOL	QIY

## DIMENSIONS

MODEL	TAHOE
MODEL NUMBER	CK10516
<b>EXTERIOR DIMENSIONS</b>	
<b>BODY</b>	
Wheelbase (in.)	111.5
Overall Length (in.)	188.5
Overall Height (in.)	72.4
Maximum Width (in.)	77.1
Bumper to Axle (in.)	
Front	35.9
Rear	41.1
Ground to Top of Rear Load Floor (in.)	31.1
Ground Clearance (in.)	
Front/Rear	6.9/7.1
Turning Diameter	
Curb-to-Curb (ft)	41.5
<b>SIGN PANEL AREA (in.)</b>	17 x 48.75

<b>INTERIOR DIMENSIONS</b>	
Headroom (in.)	
Front/Rear	39.9/37.8
Legroom (in.)	
Front/Rear	41.9/36.4
Shoulder Room (in.)	
Front/Rear	65.4/66.0
Hip Room (in.)	
Front/Rear	60.0/60.7
Cargo Volume (cu ft) w/ Rear Seat w/ Rear Seat Down	51.6 99.4





- **5.7 Liter V8 Engine with Electronic Fuel Injection** — provides 200 hp @ 4000 rpm and 310 lb.-ft. of torque @ 2400 rpm. Capable of towing up to 7000 lbs., when properly equipped.
- **Standard Insta-Trac® 4x4 System** — lets driver shift from 2WD to 4WD High and back at any speed. No system is better proven or more widely chosen.
- **Independent Front Suspension** — allows each wheel to step over bumps independently to help smooth the ride.
- **Available 6.5L V8 Turbo-Diesel Power** — provides impressive high-peak torque, ideal for trailering. Operation is virtually smokeless.

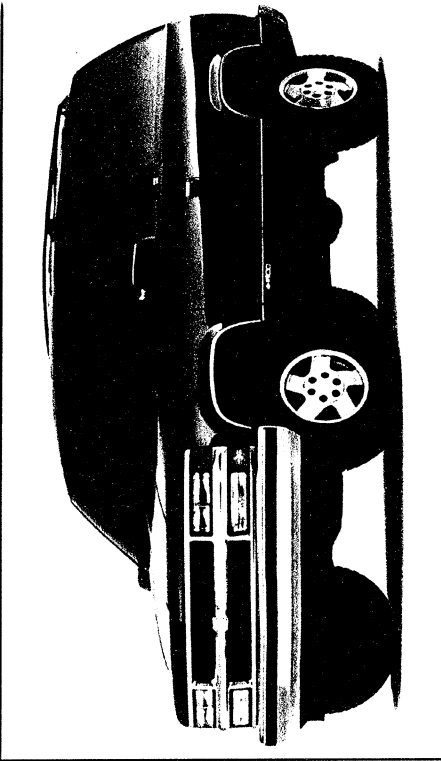

- **New Rear Cargo Doors** — give buyers a choice of rear-door configurations. Tailgate with lift-glass optional at no extra charge.
- **Choice of Trim Levels** — choice of Base (standard), LS/LT or Sport Package decor (requires LS or LT trim level), offers wide range of comfort, appearance and convenience features.
- **Manual and Automatic Transmissions** — standard 5-speed manual or optional 4-speed electronically controlled automatic transmission for virtually seamless shifting.
- **Sound Systems** — available systems to fit a range of budgets and needs include cassette tape or CD players and dual playback CD and cassette with Auto Tone Control and Speed-Compensated Volume Control.

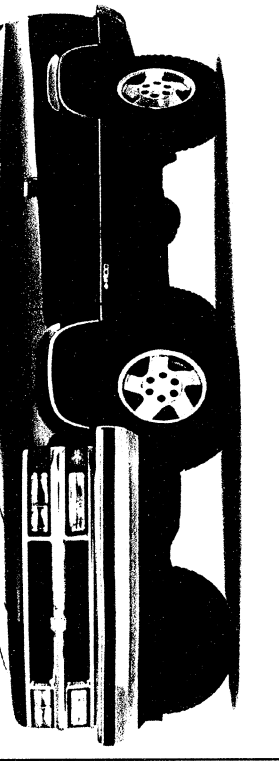

- **Folding Rear Seat-Back** — versatility of over 99 cu. ft. of cargo space when folded down, 5-passenger comfort when up.
- **Two-Stage Variable-Rate Multi-Leaf Springs** — on rear suspension, provide excellent ride under light loads and strong support capability under heavy loads.
- **Steel Ladder-Type Frame with Drop-Center Design** — makes possible reduced step-in height for easy entry/exit, high ground clearance for off-road driving.
- **Tow Hooks** — easily accessible, a strong attaching point for chains or tow straps.

### FEATURE VEHICLES

There are two Tahoe 2-Door Feature Vehicles for 1995 — the Tahoe LT with Sport trim and the Tahoe LT (detailed on the following sheet). The LT features the newly available leather seating surfaces, which bring a new degree of luxury to this vehicle.

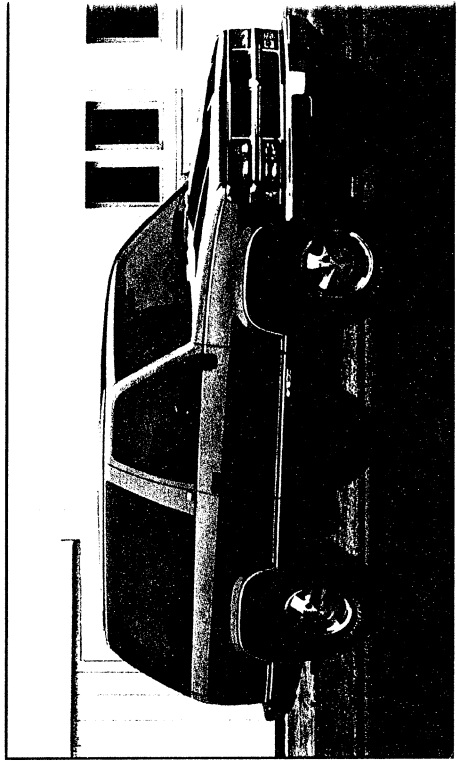
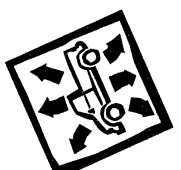

- **TO OWN • 4-Door Model Availability (interim '95)** — makes possible true station wagon versatility for Tahoe owners.
- **Scotchgard™ Protector** — on cloth seats, door panels and carpet, resists stains for easy cleanup.
- **Solar-Ray Tinted Glass** — reduces the total solar energy transmission by one-third.
- **ON THE MIND • Standard Driver-Side Air Bag (Supplemental Inflation Restraint)** — helps prevent injuries in certain moderate to severe frontal collisions. Always wear safety belts, even with air bags.
- **Standard Four-Wheel Anti-Lock Brake System (ABS)** — prevents wheel lockup while braking and is designed to help the driver maintain steering control and prevent skidding when braking on most slippery surfaces.

### FOCUS VEHICLE

For 1995 is the Tahoe 2-Door with LS trim. This vehicle is purchased primarily for recreation, offering dependable, long-lasting on- and off-road performance. When equipped with PEG 1SBX, this model represents an excellent opportunity for Tahoe sales at your dealership.



- **Base-Coat/Clear-Coat Paint** — high-gloss shine, long-lasting exterior finish resists fading.
- **Two-Side-Galvanized Steel** — outer-body

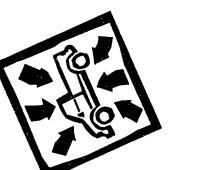

- **NEW TAHOE IDENTIFICATION REPLACES BLAZER NAME**
- **NEW DRIVER-SIDE AIR BAG**
- **NEW INTERIOR**



# WHEELS

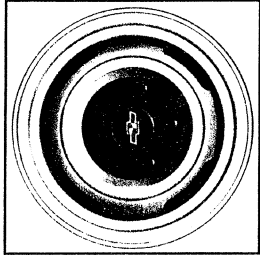

Standard steel, painted argent with black hub ornament — Base.

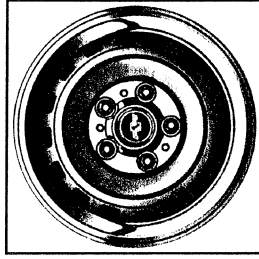

Optional Rally Wheel trim with bright trim ring.

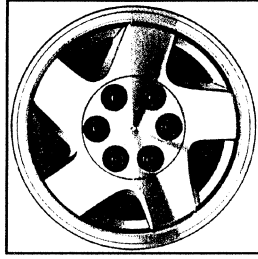

Optional 4WD cast-aluminum wheel — standard on LS/LT.

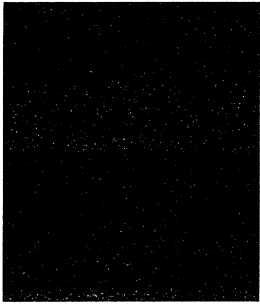

LT Leather seating surfaces available in Beige, Blue, Gray and Red.

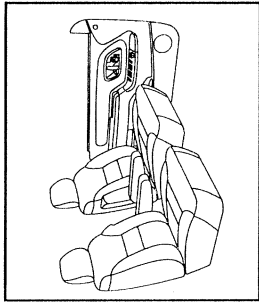

Reclining high-back Custom Leather seating surfaces — LT.

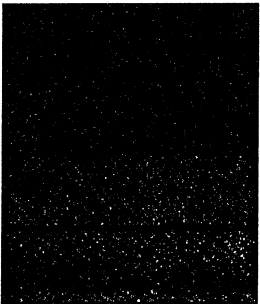

LS Custom Cloth available in Beige, Blue, Gray and Red.

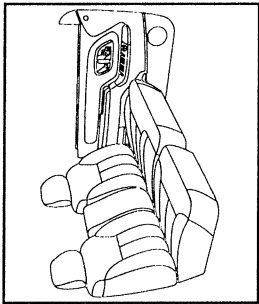

Reclining Custom Cloth split-bench seat — LS.

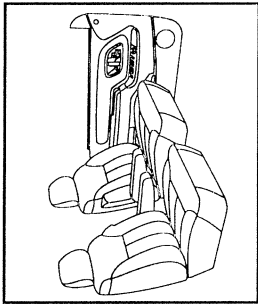

Reclining Custom Cloth high-back bucket seats — LS.

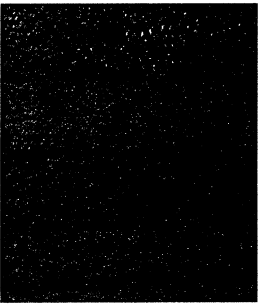

Base Vinyl available in Beige, Blue, Gray and Red

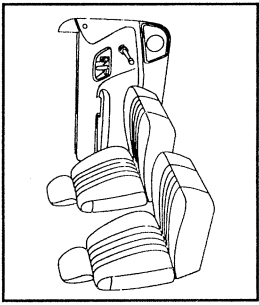

Reclining Vinyl low-back bucket seats — Base trim level.

## MOST POPULAR EXTERIOR COLORS BY PERCENTAGE

Clockwise below are the anticipated four most popular Tahoe 2-Door colors for 1995, based on national sales volume. They are listed for reference only. To identify the top-selling colors in your area, by model, use the Retail Sales Analysis (RSA).

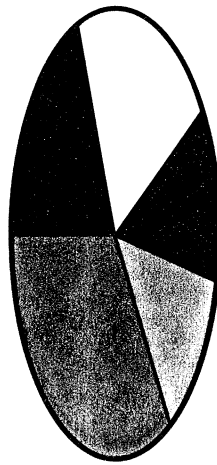

## MOST POPULAR EXTERIOR COLORS WITH CORRESPONDING INTERIOR COLOR AVAILABILITY

Exterior Colors	Interior Material Colors			
	Beige	Blue	Gray	Red
Onyx Black	●	●	●	●
Summit White	●	●	●	●
Emerald Green	●	●	●	●
Victory Red	●	●	●	●



## FEATURE VEHICLES: TAHOE LT WITH SPORT APPEARANCE PACKAGE AND TAHOE WITH LT TRIM

The first 1995 Feature vehicle is the Tahoe LT with Sport Package and Preferred Equipment Group 1SCX. It includes all of the LT content items, plus the following Sport Package features:

- Uplevel Gunmetal Gray Grille
- Gunmetal Gray Front and Rear Bumpers
- Gunmetal Gray Wheel-Opening Flare Moldings
- Sport Two-Tone Paint.

The second Feature vehicle is the Tahoe LT. It features:

- Chrome Front and Rear Bumpers
- Dual Composite Halogen Headlamps
- Leather Seating Surfaces
- Rally Wheels.

## FOCUS VEHICLE: TAHOE 2-DOOR WITH LS TRIM

### Ordering Recommendations:

The recommended Tahoe LS content, based on national sales volume, is listed below to assist your dealership in ordering.

Tahoe LS with Preferred Equipment Group 1SBX includes:

- LS Decor (YE9), including Custom Cloth Split-Bench Seat, Power Door Locks and Power Windows
- Air Conditioning
- 4-Spoke Leather-Wrapped Steering Wheel
- AM/FM Stereo with Seek-Scan, Auto Tone Control, Digital Clock, Cassette Tape Player, TheftLock™ and Speed-Compensated Volume Control
- Cast-Aluminum Wheels
- Rear Wiper/Washer (with tailgate/lift-glass only)
- Rear Defogger
- Luggage Carrier.

**NOTE: Model, PEG and optional content may vary in your locality. Use the Retail Sales Analysis (RSA) to verify or select your dealership's Tahoe Focus vehicle content.**

## '95 PRODUCT POSITIONING

Tahoe 2-Door is positioned as the rugged, multi-purpose family vehicle that's at home on road or off. Its Insta-Trac® system (standard on 4x4 models), powerful 5.7L V8 engine, 2- or 4-door availability (interim '95), ABS and high ground clearance are impressive credentials.

New Tahoe owners rank features that support an active lifestyle, such as towing capacity, versatility and rain/snow traction, as top reasons for purchase.

Tahoe owners are generally more affluent than other segment buyers. They're usually young married males who tend to work in either managerial or labor-related fields.

## COMPETITIVE VEHICLES

Ford Bronco  
Jeep Grand Cherokee  
Ford Explorer.

<b>Series</b>	
K1500	100%
Total	100%
<b>Models</b>	
4WD	100%
Total	100%
<b>Trim Levels</b>	
Base	2%
LS	75%
LT	23%
Total	100%
<b>Engines</b>	
5.7L V8 EFI	90%
6.5L Turbo-Diesel V8	10%
Total	100%
<b>Transmissions</b>	
5-Speed Manual with Overdrive	1%
4-Speed Electronically Controlled Automatic with Overdrive	99%
Total	100%

- The Blazer name for the Chevrolet full-size sport utility has been deleted for 1995.
- In its place is the name "Tahoe."
- Cheyenne and Silverado trim level names have been deleted. They have been replaced by "Base" and "LS/LT," respectively, where LS refers to uplevel trim with Custom Cloth and LT refers to the available interior with leather seating surfaces. The Sport trim name, however, remains the same and is contented as a marketing package (BYP).
- Deluxe Two-Tone paint scheme (RPO ZY4) has been deleted.
- Dark Autumnwood Metallic paint has been deleted.

## ADDITIONAL INFORMATION ON SIGNIFICANT FEATURES

- New Tahoe name identification. For 1995, all Chevy Full-Size Sport Utility models are called Tahoe. This new name clearly separates full-size and compact Chevrolet sport utilities, thus helping strengthen the identity of both in the highly competitive sport utility market segment.
- New 4-door Tahoe model (interim 1995). Because of the growing popularity of the 4-door sport utility market segment, Tahoe will be available in a 4-door model beginning January '95. Featured will be Suburban styling and chassis features on a shorter wheelbase, panel rear cargo doors, LS/LT (uplevel) trim level and full-size spare tire stowed underbody.
- New standard driver-side air bag (Supplemental Inflatable Restraint). An important safety feature, it can help protect the driver in certain moderate to severe frontal collisions. Always wear safety belts, even with air bags.
- New interior. Tahoe for 1995 boasts a more appealing interior than ever before, thanks to features like a new instrument panel, new door panels, new floor console (with bucket seats only), new, more comfortable seats and new interior colors. Power windows, power door locks and power mirrors are standard on uplevel LS/LT. In addition, all uplevel seats have power lumbar support and front seat-back storage nets.

**STANDARD INTERIOR FEATURES**

	BASE	LS	LT
AIR BAG: DRIVER'S SIDE	\$	\$	\$
CUPHOLDERS: DUAL IN DASH	\$	\$	\$
DOOR BEAMS: SIDE IMPACT	\$	\$	\$
GAGES: OIL PRESSURE, TACHOMETER, TRIP ODOMETER AND VOLT METER	\$	\$	\$
GLASS: SOLAR RAY TINTED, ALL WINDOWS	\$	\$	\$
JACK: WITH WHEEL WRENCH	\$	\$	\$
LIGHTING: DOME W/LH & RH DOOR SWITCH, READING ASHTRAY, GLOVE-BOX, UNDERHOOD AND CARGO LAMPS	\$	\$	\$
POWER POINTS: DUAL COVERED	\$	\$	\$
SCOTCHGARD: ALL CLOTH AND CARPET SURFACES	\$	\$	\$
WARNING TONE: KEY-IN-IGNITION BUZZER	\$	\$	\$

**STANDARD EXTERIOR FEATURES**

	BASE	LS	LT
AIR DAM: DARK ARGENT	\$	\$	\$
KEY: SINGLE TWO SIDED	\$	\$	\$
SPARE TIRE: FULL SIZE SPARE TIRE & WHEEL	\$	\$	\$
TAILGATE: REMOVABLE	\$	\$	\$
TOW HOOKS: TWO FRONT ON 4X4 MODELS	\$	\$	\$
WIPERS: INTERMITTENT WINDSHIELD W/PULSE WASHERS	\$	\$	\$
WIRE HARNESS: 7 WIRE TRAILERING	\$	\$	\$

**STANDARD CHASSIS FEATURES**

	BASE	LS	LT
BATTERY: HEAVY-DUTY 600 CCA	\$	\$	\$
BRAKES: POWER ASSISTED FRONT DISC, REAR DRUM W/4-WHEEL ANTI-LOCK AND TRANSMISSION SHIFT INTERLOCK W/AUTO TRANS	\$	\$	\$
ENGINE: 5.7 LITER V8 GAS W/ELECTRONIC FUEL INJECTION	\$	\$	\$
FUEL TANK: 30 GAL	\$	\$	\$
GENERATOR: 100 AMP	\$	\$	\$
STEERING: POWER ASSISTED	\$	\$	\$
SUSPENSION FRT: INDEPENDENT TORSION BAR	\$	\$	\$
SUSPENSION RR: HYPOID DRIVE W/LEAF SPRINGS	\$	\$	\$
TRANSMISSION: 5-SPEED MANUAL	\$	\$	\$

AIR CONDITIONING:			
ASSIST HANDLES: RF FRONT SEAT -- LH & RH REAR SEAT	S	S	S
CONVENIENCE GP: POWER WINDOWS, LOCKS AND OUTSIDE MIRRORS	--	S	S
POWER LOCKS ONLY	O	--	--
TILT WHEEL AND CRUISE CONTROL	O	S	S
DOOR TRIM:			
MOLDED PLASTIC W/ARMREST	S	--	--
COLOR-KEYED CLOTH AND CARPET TRIMMED	--	S	S
FLOOR COVERING: FULL BLACK RUBBER	S	--	--
COLOR-KEYED CARPET W/RUBBER MATS	--	S	S
HEADLINER: COLOR-KEYED CLOTH	S	S	S
MAP POCKETS: IN PASSENGER & DRIVER'S DOOR	--	S	S
RADIO:			
AM/FM STEREO W/SEEK & SCAN	S	--	--
AM/FM STEREO W/SEEK & SCAN, CLOCK AND CASSETTE TAPE W/AUTO TONE CONTROL	O	S	S
SEATING FRT:			
VINYL LOW BACK BUCKET SEATS	S	--	--
CUSTOM CLOTH 60/40 SPLIT BENCH	--	S	--
CUSTOM CLOTH HIGH BACK BUCKETS	--	O	--
LEATHER HIGH BACK BUCKETS	--	--	S
SEATING RR:			
3 PASSENGER FOLDING	S	S	S
SPARE TIRE COVER: COLOR-KEYED, CLOTH COVER	--	S	S
STEERING WHEEL: SIMULATED LEATHER LEATHER	S	--	--
SUNSHADES:			
CLOTH W/LH STORAGE STRAP & RH MIRROR	S	--	--
LH STORAGE STRAP & RH LIGHTED MIRROR	--	S	S

### EXTERIOR TRIM

	BASE	LS	LT
BUMPERS FRT:			
CHROME WITH BLACK RUB STRIPS	S	--	--
CHROME WITH BLACK RUB STRIPS & BRIGHT TRIM	--	S	S
BUMPER RR:			
CHROME WITH STEP PAD	S	S	S
CARRIER: ROOF MOUNTED LUGGAGE CARRIER	--	S	S
GRILLE:			
MOLDED PAINTED ARGENT	S	--	--
CHROME DELUXE	--	S	S
HEADLAMPS:			
SINGLE RECTANGULAR HALOGEN	S	--	--
DUAL COMPOSITE HALOGEN	--	S	S
HORN:			
SINGLE NOTE	S	--	--
DUAL NOTE	--	S	S
LICENSE HOLDER: FRONT BUMPER	O	O	O
MIRRORS:			
BLACK BREAK-A-WAY	S	--	--
BLACK ELECTRIC OSRV	--	S	S
MOLDINGS:			
BODY SIDE WITH BRIGHT TRIM AND BRIGHT WHEEL OPENING TRIM	--	S	S
NAMEPLATES:			
NONE	S	--	--
LS BADGE ON B-PILLAR	--	S	--
LT BADGE ON B-PILLAR	--	--	S
PAINT:			
SINGLE TONE	S	S	S
TWO-TONE SUBSTITUTE	--	O	O
WHEELS:			
SILVER PAINTED W/BLACK CENTER CAP	S	--	--
RALLY WHEEL TRIM	O	--	--
ALUMINUM	O	S	S

\*Includes Destination & Handling Charges

**EMISSIONS (Must Order One) (Refer Emission Requirements Section)**

- FE9 Federal Emission Requirements
- YF5 California Emission Requirements
- NG1 Massachusetts State Emissions Requirements
- NB8 California or Massachusetts State Emission Override (Reqs FE9 Federal Emissions)
- NC7 Federal Emission Override (Reqs YF5 California or NG1 Massachusetts State Emissions)

**POWER TEAMS (Must Order Engine, Transmission and Rear Axle)**

(Consult GVWR Selector For Minimum Equipment Required)

ENGINE	TRANSMISSION	AXLES	GVWR
5-SP Lt Duty	AUTO Lt Duty / H Duty	3.42	3.73
<b>K10516</b>			
L05 V8 5.7 Liter (350 Cu In) EFI	M30	GU6	GT4
L56 V8 Turbo Diesel 6.5 Liter (400 Cu In)	MT1	(a) GU6	(a) GT4

(a)/N/A YF5 California Emissions

**GVWR SELECTOR (MUST SPECIFY GVW OPTION)**

GVW OPT	GVW Rating (lbs)	(a) GAWR (lbs) Front	Rear
C5P	6250	3600	3750
C7I	6450	3600	3750

N/A L56 Eng  
Reqs L56 Eng

(a) GAWR's shown are the minimum for each axle with equipment listed. Other GAWR's are available and they are determined as the minimum capacity of either axle, springs or tires.

**CAPACITIES**

SPRINGS:	AXLES:
Front	Front
3925 Base	3880 Base
Rear	Rear
3750 Base	3880 Base

**MUST SPECIFY:**

**AXLE, BODY CODE, EMISSION, ENGINE, TIRES AND TRANSMISSION**

**No Deletions Allowed. Additional Options/Upgrades (Where Indicated) May be Ordered from the Custom Ordering Option Listing.**

	Decor		
	BASE	LS	LT
<b>BASE DECOR</b> .....	1	1	1
	S	S	S
	A	B	C
	X	--	--
<b>LS DECOR</b> .....		X	--
Air Conditioning .....		X	X
ATC Stereo Cassette (A) .....		X	X
Glass, Deep Tinted .....		X	X
Rear Wiper/Washer w/Defogger (E55 Body Only) .....		X	X
Rear Window Defogger (ZW9 Only) .....		X	X
Luggage Carrier .....		X	X
Wheels, Aluminum .....		X	X
<b>LT DECOR</b> .....			X
Power Seat .....			X
Remote Keyless Entry .....			X

(A) May upgrade

**Preferred Equipment Group Prices**

N/C	1SA
1SB	
3989.00	w/E55
3928.00	w/ZW9
1SC	
5641.00	w/E55
5580.00	w/ZW9

**SPORT PACKAGE: Ordering Option BYP**

Reqs PEG 1SB or 1SC  
 Reqs L05 Eng, QBN, OIT or QIX Tires  
 (Refer Page 9 for available Paint and Trim Applications)

Includes:  
 Dark Argent Colored  
 Uplevel Grille, Wheel Flares, Front Bumper w/Rubber Strip,  
 Rear Bumper w/Rubber Strip and Step Pad

Black Colored  
 Front License Bracket  
 Front Air Dam  
 Mirrors  
 Sport Decals

W/DECOR

Base	LS	LT	OPTION
N.C.			R8S
N.C.	x		R8T
N.C.		x	C60
845.00			
N.C.			GU6
N.C.			GT4
252.00			G80
N.C.			ZW9
N.C.			E55
400.00			Z71
33.00		x	V10
N.C.	x		ZQ3
383.00			
N.C.			KC4
135.00			
N.C.			KNP
96.00			
N.C.			C49
154.00	x		
N.C.			FE9
100.00			YF5
N.C.			NG1
N.C.			NB8
N.C.			NC7
N.C.			L05
2860.00			L56
215.00	x		AJ1
N.C.			CSP
N.C.			C71
N.C.			AU0
N/A			
N.C.			VK3
135.00			AU3
N.C.			
N.C.			DF2
156.00			
220.00			
(-45.00)			
53.00			DD7
145.00			B71
N/A			
N.C.			ZY1
180.00			ZY2
N.C.			
N.C.			
N.C.			
180.00			

**ACKNOWLEDGEMENTS:**

Multiple Order Numbers  
Preliminary Invoice

**AIR CONDITIONING**

w/1SB or 1SC  
w/1SA

**AXLES, REAR:** (Refer Power Teams Chart for Availability)

3.42 Ratio  
3.73 Ratio  
Locking Differential

**BODY CODE:** (Must Order One)

Base, Panel Door  
Tailgate (Lift Glass w/Drop Gate and Power Release)

**CHASSIS EQUIPMENT:** Off-Road Package (Reqs Q1X or Q1Y Tires w/o BYP Sport Pkg)  
(Reqs Q1X w/BYP Sport Pkg) (Incls NZZ Skid Plate Pkg and Blstein Shock Absorbers)

**COLD CLIMATE PACKAGE:** (Incls Eng Block Heater) (Reqs L05 Eng)

**CONVENIENCE GROUP:** Tilt Wheel and Speed Control  
w/1SB or 1SC  
w/1SA

**COOLING SYSTEM:**

Engine Oil (Reqs L05 Eng)  
w/Z82

w/o A82

Transmission, Heavy-Duty, Auxiliary (Reqs AutoTrans)

w/MT1 or Z82 and M30

w/o MT1 or w/o Z82 and M30

**DEFOGGER:** Rear Window, Electric (Reqs ZW9 Body)

w/1SB or 1SC  
w/1SA

**EMISSIONS:** (Refer Emission Requirement Tab Section)

Federal Emission Requirements

California Emission Requirements

Massachusetts Emission Requirements

California or Massachusetts Emission Override (Reqs FE9 Federal Emissions)

Federal Emission Override (Reqs YF5 California or NG1 Massachusetts Emissions)

**ENGINES:** (Refer Power Teams Chart)

V8 5.7 Liter (350 Cu In)-EFI

V8 6.5 Liter (400 Cu In)-Turbo Diesel (Incls Front Bumper Guards) (N/A BYP Sport Pkg)

**GLASS:** Deep Tinted

6250#  
6450#

**GVWR: (Must Specify One)** (Refer GVWR Selector Chart for Availability)

w/1SC

**KEYLESS ENTRY:** Remote

w/1SB

**LICENSE PLATE BRACKET:** Front

**LOCKS:** Power Door

w/1SB or 1SC  
w/1SA w/E55  
w/1SA w/ZW9

**MIRRORS:**

Camper Type Stainless Steel (N/A BYP Sport Pkg)

w/1SB or 1SC  
w/1SA

10" Electromagnetic ISRV with 8 Point Compass

**MOLDING:** Wheel Flares (Refer Color/Trim Charts For Availability) (Incl w/ BYP Sport Pkg)

w/BYP  
w/o BYP

**PAINT, EXTERIOR:** (Refer Color/Trim Charts for Availability)

Solid (N/A BYP Sport Pkg)

Conventional Two-Tone  
w/BYP  
w/o BYP

Base	LS	LT	OPTION
147.00	N/A	N/A	<b>RADIO EQUIPMENT:</b> Electronically Tuned AM/FM Stereo Radio w/Seek-Scan, Stereo Cassette Tape and Digital Clock
N.C.	x	x	Electronically Tuned AM/FM Stereo Radio w/Seek-Scan w/Automatic Tone Control, Digital Clock Cassette Tape, Theft Lock and Speed Compensated Volume (Incls Enhanced Performance Speaker System)
200.00	N/A		Electronically Tuned AM/FM Stereo Radio w/Seek-Scan w/Automatic Tone Control, Compact Disc Player, Digital Clock, Cassette Tape, Theft Lock and Speed Compensated Volume (Incls Enhanced Performance Speaker System) (Reqs M30 or MT1 Trans)
(-287.00)	N/A	N/A	Radio Delete
N.C.	x	x	<b>REAR WINDOW EQUIPMENT:</b> Wiper/Washer System with Defogger (Incls Wiper Washer System; also includes Rear Window Defogger) (Reqs E55 Body)
279.00			w/1SB or 1SC
240.00	N/A	x	w/1SA
N.C.			<b>SEAT:</b> Power Driver's Seat
N.C.			<b>SEAT TYPE:</b> (Refer Color/Trim Chart for Availability)
			Low Back Reclining Bucket Seats (Incls Center Console)
			Reclining 60/40 Split Bench Seat
			Reclining High Back Bucket Seats (Incls Center and Roof Console)
			w/1SC
277.00			w/1SA or 1SB
N.C.			<b>SKID PLATE PACKAGE:</b>
225.00			w/Z71
302.00			w/o Z71
			<b>SPORT PACKAGE:</b> (Refer Standard Features Page 2 for Package Content) (Reqs K10516 and ZY2 Paint Application)
63.00			<b>SPRINGS:</b> Front, Heavy-Duty (Reqs L05 Eng)
N.C.			TIRES: Tubeless (BW - Blackwall; WOL - White Outlined Letters) (Front, Rear and Spare)
57.05			LT245/75R16-C All Seasons Steel Belted Radial Ply BW
190.95			LT245/75R16-C On-Off Road Steel Belted Radial Ply BW
315.95			LT265/75R16-C On-Off Road Steel Belted Radial Ply BW
			LT265/75R16-C On-Off Road Steel Belted Radial Ply WOL (N/A BYP Sport Truck)
			<b>TRAILERING SPECIAL EQUIPMENT:</b> Heavy-Duty (Incls Trailer Hitch Platform and Hitch, Wiring Harness) (Reqs Auto Trans)
164.00			w/Diesel Eng
395.00			w/o Diesel Eng
N.C.			<b>TRANSMISSIONS:</b> (Refer Power Teams Chart)
930.00			5-Speed Manual, Light Duty
930.00			4-Speed Electronically Controlled Automatic w/Overdrive
60.00			4-Speed Electronically Controlled Automatic w/Overdrive, Heavy-Duty
N.C.			<b>WHEEL TRIM:</b> Rally (N/A, PF4 Wheels)
			<b>WHEELS:</b> Aluminum (Spare is Steel Wheel)
			w/1SB or 1SC
			w/1SA



**PAINT APPLICATIONS WITH ZY1 AND ZY2 PAINT  
W/O BYP SPORT PACKAGE**

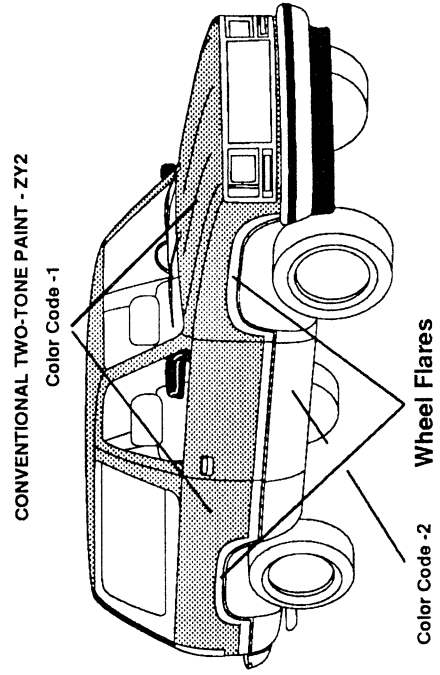
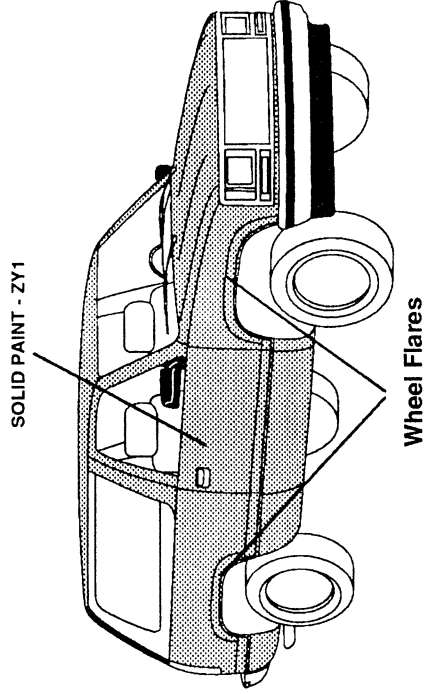

**PLEASE NOTE:** Below are the interior trim color and exterior paint combinations recommended by Chevrolet. They are the only available interior and exterior combinations allowed.

TRIM LEVEL (Must Specify Seat Option and Interior Color)	SEAT OPT	INTERIOR COLORS			
		Beige	Blue	Gray	Red
<b>Seat Type</b> <b>CHEYENNE (STD DECOR)</b> Vinyl Reclining Back Bkt Seats	A50	64V	26V	13V	79V
<b>LS PACKAGE</b> Custom Cloth Reclining Split Bench Seat Custom Cloth Reclining High Back Bucket Seats (Incls Roof/Floor Console)	AE7	64D	26D	13D	79D
	A95	64D	26D	13D	79D
<b>LT PACKAGE</b> Custom Leather Reclining High Back Bkt Seats (Leather on Seating Surface Only)	A95	642	262	132	792
<b>EXTERIOR COLORS</b>	<b>PAINT SCHEME</b>	<b>INTERIOR &amp; EXTERIOR COMBINATIONS SHOWN ARE THE ONLY COMBINATIONS AVAILABLE</b>			<b>WHEEL FLARE W/B71 MOLDING</b>
<b>w/ZY1 PAINT</b>	<b>Color Code 1</b>				
AUTUMNWOOD, LT (Met)	55U	ZY1	x		Autumnwood
BLACK, ONYX	41U	ZY1	x	x	Black
BLUE, ATLANTIC (Met)	30U	ZY1	x		Argent
BLUE, INDIGO (Met)	39U	ZY1	x	x	Blue
BLUE, TEAL (Met)	36U	ZY1	x		Argent
GREEN, EMERALD (Met)	43U	ZY1	x		Argent
QUICKSILVER (Met)	96U	ZY1	x	x	Silver
RED, BURNT (Met)	76U	ZY1	x		Red
RED, VICTORY	74U	ZY1	x	x	Argent
WHITE, SUMMIT	50U	ZY1	x	x	Argent

### INTERIOR AND EXTERIOR COLOR AVAILABILITY CHART ZY2 PAINT Reqs LS/LT Decor (N/A BYP Sport Package)

EXTERIOR COLORS w/ZY2 PAINT	Color Code 1	**Color Code 2	PAINT SCHEME	INTERIOR & EXTERIOR COMBINATIONS SHOWN ARE THE ONLY COMBINATIONS AVAILABLE			WHEEL FLARE W/B71 MOLDING
BLACK, ONYX/Autumnwood, Lt (Met)	41U	55L	ZY2	x			Autumnwood
BLACK, ONYX/Quicksilver (Met)	41U	96L	ZY2		x	x	Silver
BLUE, ATLANTIC (Met)/Blue Indigo (Met)	30U	39L	ZY2		x		Blue
BLUE, ATLANTIC (Met)/Quicksilver (Met)	30U	96L	ZY2		x		Silver
BLUE, TEAL (Met)/Autumn, Lt (Met)	36U	55L	ZY2	x			Autumnwood
BLUE, TEAL (Met)/Quicksilver (Met)	36U	96L	ZY2		x		Silver
BLUE, INDIGO (Met)/Autumn, Lt (Met)	39U	55L	ZY2	x			Autumnwood
*BLUE, INDIGO (Met)/Blue, Atlantic (Met)	39U	30L	ZY2		x		N/A
BLUE, INDIGO (Met)/Quicksilver (Met)	39U	96L	ZY2		x		Silver
GREEN, EMERALD (Met)/Autumn, Lt (Met)	43U	55L	ZY2	x			Autumnwood
GREEN, EMERALD (Met)/Quicksilver (Met)	43U	96L	ZY2		x		Silver
QUICKSILVER (Met)/Black, Onyx	96U	41L	ZY2		x	x	Black
*QUICKSILVER (Met)/Blue, Atlantic (Met)	96U	30L	ZY2		x		N/A
QUICKSILVER (Met)/Blue, Indigo (Met)	96U	39L	ZY2		x		Blue
QUICKSILVER (Met)/Red, Burnt	96U	76L	ZY2		x		Red
RED, BURNT (Met)/Autumn, Lt (Met)	76U	55L	ZY2	x			Autumnwood
RED, BURNT (Met)/Quicksilver (Met)	76U	96L	ZY2		x		Silver
RED, VICTORY/Black, Onyx	74U	41L	ZY2		x		Black
RED, VICTORY/Quicksilver (Met)	74U	96L	ZY2		x		Silver
WHITE, SUMMIT/Autumn, Lt (Met)	50U	55L	ZY2	x			Autumnwood
WHITE, SUMMIT/Blue, Indigo (Met)	50U	39L	ZY2		x		Blue
WHITE, SUMMIT/Red, Burnt	50U	76L	ZY2		x		Red

\*N/A B71 Molding

\*\*Color Code 2 Must be ordered as a (+) Plus option

**PLEASE NOTE:** Below are the interior trim color and exterior paint combinations recommended by Chevrolet. They are the only available interior and exterior combinations allowed.

TRIM LEVEL (Must Specify Seat Option and Interior Color) Seat Type	SEAT OPT	INTERIOR COLORS			
		Belige	Blue	Gray	Red
<b>LS PACKAGE</b> Custom Cloth Reclining Split Bench Seat Custom Cloth Reclining High Back Bucket Seats (Incls. Roof/Floor Console)	AE7 A95	64D 64D	26D 26D	13D 13D	79D 79D
<b>LT PACKAGE</b> Custom Leather Reclining High Back Bkt Seats (Leather on Seating Surface Only)	A95	642	262	132	792
<b>EXTERIOR COLORS w/ZY2 PAINT</b>	<b>Color Code 1</b>	<b>**Color Code 2</b>	<b>PAINT SCHEME</b>	<b>INTERIOR &amp; EXTERIOR COMBINATIONS SHOWN ARE THE ONLY COMBINATIONS AVAILABLE</b>	
AUTUMNWOOD, LT (Met)	55U	91L	ZY2	x	
BLACK, ONYX/Gray, Gunmetal (Met)	41U	91L	ZY2	x	x
GREEN, EMERALD (Met)	43U	91L	ZY2	x	x
QUICKSILVER (Met)	96U	91L	ZY2	x	x
RED, BURNT (Met)	76U	91L	ZY2	x	x
RED, VICTORY/Gray, Gunmetal (Met)	74U	91L	ZY2		x
WHITE, SUMMIT/Gray, Gunmetal (Met)	50U	91L	ZY2	x	x

**\*\*Color Code 2 Must be ordered as a (+) Plus option**

**NOTE: W/B71, Wheel Flare Color Matches Color Code 2**

Color Code 1

Color Code 2

