

# 1997

## CAMARO

E  
③

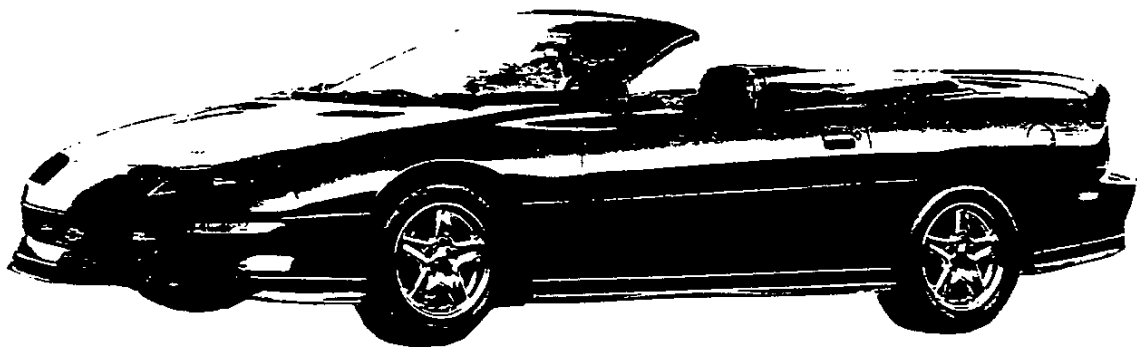

GENUINE CHEVROLET



# CAMARO

REVISED 8-19-96

1997 ORDER GUIDE

CAMARO  
Page 1

Prices Shown Are Manufacturer's Suggested Retail Prices (MSRP) At the Time of Publication. These Prices Are To Be Used Only As An Aid To Inventory Management Since MSRP Figures Change Periodically. The Vehicle Price Schedule Is The Official Pricing Documentation Of Chevrolet Motor Division And Should Be Used In Discussing Vehicle Prices With Potential Buyers. The Model Prices Shown In The Order Guide Include The Destination Freight Charges.

## CAMARO EQUIPMENT SUMMARY

		1FP87 BASE/RS	1FP67 BASE/RS	1FP87 Z28	1FP67 Z28
<b>STANDARD INTERIOR FEATURES</b>					
AIR CONDITIONING:		S	S	S	S
CLOSEOUT PANEL:	CARGO COMPARTMENT AREA	S	S	S	S
DEFOGGERS:	REAR WINDOW	--	S	--	S
	SIDE WINDOWS	S	S	S	S
GAGES:	GAGE PKG WITH TACHOMETER AND SPEEDOMETER	S	S	S	S
GLASS:	REAR WINDOW	--	S	--	S
	TINTED, SOLAR-RAY	S	S	S	S
LIGHTING:	COURTESY REAR SEAT AND TRUNK	--	S	--	S
	DOMES	S	--	S	--
RESTRAINT SYSTEM:	DRIVER AND PASSENGER SIDE AIR BAGS	S	S	S	S
SCOTCHGARD:	FABRIC PROTECTOR, INCLUDES SEATS, DOOR TRIM AND FLOOR COVERING	S	S	S	S
SPEEDOMETER:	150 MPH	--	--	S	S
	125 MPH	S	S	-	-
WARNING LIGHTS:	CHECK GAGES	S	S	S	S
	LOW COOLANT LEVEL	--	--	S	S
	LOW OIL LEVEL	S	S	S	S
WARNING TONE:	HEADLAMPS-ON	S	S	S	S
<b>STANDARD EXTERIOR FEATURES</b>					
HARD BOOT:	THREE PIECE WITH STORAGE BAG	--	S	--	S
PAINT:	2 COMPONENT CLEAR-COAT	S	S	S	S
PASS KEY II:	THEFT DETERRENT SYSTEM	S	S	S	S
ROOF:	SPECIAL BLACK TREATMENT (W/BLACK MIRRORS)	--	--	S	--
SPOILER:	INTEGRAL, REAR	S	S	S	S
TIRES:	COMPACT SPARE, HIGH PRESSURE	S	S	S	S
	P215/60R-16 B/W (BASE ONLY)	S	S	--	--
	P235/55R-16 B/W *(RS COUPE & CONV ONLY)	S*	S*	S	S
TOP:	FOLDING, POWER	--	S	--	S
WIPERS:	INTERMITTENT	S	S	S	S
<b>STANDARD CHASSIS FEATURES</b>					
AXLE:	REAR, LIMITED SLIP	--	--	S	S
BATTERY:	RUNDOWN PROTECTION	S	S	S	S
BELT:	ACCESSORY DRIVE, SINGLE SERPENTINE	S	S	S	S
BRAKES:	4-WHEEL ANTI-LOCK	S	S	S	S
	DISC, POWER FRONT AND REAR	--	--	S	S
	POWER FRONT DISC AND REAR DRUM	S	S	--	--
	BRAKE/TRANSMISSION SHIFT INTERLOCK (AUTO TRANS ONLY)	S	S	S	S
EXHAUST:	SYSTEMS, STAINLESS STEEL	S	S	S	S
FUEL TANK:	15.5 GALLON CAPACITY	S	S	S	S
SHOCKS:	MONOTUBE, GAS CHARGED (FRONT/REAR)	S	S	S	S
SPARK PLUGS:	PLATINUM TIP	--	--	S	S
STABILIZER BAR:	FRONT AND REAR	S	S	S	S
STEERING:	POWER RACK AND PINION	S	S	S	S
SUSPENSION:	FIRM RIDE AND HANDLING	S	S	--	--
	PERFORMANCE RIDE AND HANDLING	--	--	S	S
SUSPENSION SYSTEM:	DeCARBON FRONT, SHORT-LONG ARM	S	S	S	S
	4-WHEEL COIL SPRING W/COMPUTER-SELECTED SPRINGS	S	S	S	S
TRANSMISSION:	5-SPEED MANUAL	S	S	--	--
	6-SPEED MANUAL	--	--	S	S

## CAMARO TRIM DEFINITION & OPTION SUMMARY

INTERIOR TRIM		1FP87	1FP67	1FP87	1FP67
		BASE/RS	BASE/RS	Z28	Z28
CONSOLE:	CENTER, WITH CUP HOLDERS AND STORAGE COMPARTMENT	S	S	S	S
FLOOR COVERING:	CARPETING, FULL INCLUDES CARGO AREA FLOOR MATS, FRONT, CARPETED	S	S	S	S
HEADLINER:	FULL	--	S	--	S
MIRRORS:	REARVIEW, DAY/NIGHT WITH DUAL READING LAMPS	S	S	S	S
OUTLET:	AUXILIARY POWER IN CONSOLE	S	S	S	S
RADIO:	ELECTRONICALLY TUNED AM/FM STEREO RADIO W/SEEK-SCAN, DIGITAL CLOCK, STEREO CASSETTE TAPE SEARCH AND REPEAT AND EXTENDED RANGE REAR SPEAKERS	S	S	S	S
SEATS:	ADJUSTER, MANUAL DRIVER'S SIDE 4-WAY CLOTH TRIM	S	S	--	S
	ADJUSTER, MANUAL DRIVER'S SIDE 2-WAY CLOTH TRIM	--	--	S	--
	CLOTH RECLINING BUCKET WITH INTEGRAL HEAD RESTRAINTS W/30TH ANNIV LOGO	S	S	S	S
	REAR FULL FOLDING BACK	S	S	S	S
SPEAKER SYSTEM:	PREMIUM COAXIAL	--	S	--	S
STEERING WHEEL:	TILT WHEEL	S	S	S	S
STORAGE BIN:	COMPARTMENT IN DOORS	S	S	S	S
VISORS:	COVERED MIRROR LH & RH (W/STORAGE STRAPS)	S	S	S	S

### EXTERIOR TRIM

BUMPERS:	ENERGY-ABSORBING FRONT AND REAR 5-MPH WITH BODY COLOR FASCIAS	S	S	S	S
EXTERIOR HEADLAMPS:	SPECIAL 'RS' GROUND EFFECTS PACKAGE	S*	S*	S	S
LIGHTS:	MINIQUAD HALOGEN	S	S	S	S
MIRRORS:	DAYTIME RUNNING (AUTOMATIC)	S	S	S	S
	SPECIAL BLACK (LH REMOTE RH MANUAL)	--	--	S	--
	BODY-COLORED, DUAL SPORT (LH REMOTE/RH MANUAL)	S	S	--	S
WHEELS:	16" STEEL WITH BOLT-ON FULL WHEEL COVERS (BASE ONLY)	S	S	--	--
	16" ALUMINUM *(RS COUPE & CONV ONLY)	S*	S*	S	S

\*RS COUPE AND CONVERTIBLE ONLY

# CAMARO COUPE MODEL 1FP87

\*Includes Destination & Handling Charges

**MUST SPECIFY: ENGINE, TRANSMISSION, EMISSIONS, TIRES**  
**MUST ORDER ONE GROUP -- NO DELETIONS ALLOWED**

Base Preferred Equipment Group (Refer Standard Summary Page)	1SA	1SB	1SC
	x	x	x
<b>Preferred Equipment Group 1</b>			
Speed Control: Electronic, w/Resume Speed		x	x
Remote Hatch Release		x	x
Fog Lamps		x	x
<b>Preferred Equipment Group 2</b>			
Power Door Lock System			x
Power Windows w/Driver's Side Express Down Feature			x
Mirrors, Sport Dual Remote Electric			x
Leather Wrapped Steering Wheel: w Transmission Shifter, and Parking Brake Release Handle			x
Remote Keyless Entry w/Illuminated Interior Feature			x
Theft Deterrent Alarm System			x

## ADDITIONAL OPTIONS

### ACKNOWLEDGEMENTS

R8S	Multiple Order Numbers
R8T	Preliminary Invoice (Refer Vehicle Price Schedule)
VK3	<b>BRACKET:</b> License Plate, Front
	<b>DEFOGGER:</b> (Note: One of the Following Must Be Specified)
Q49	Rear Window, Electric
R9W	Rear Window not Desired
AU3	<b>DOOR LOCK SYSTEM:</b> Power (Reqs 1SB) (Incl With 1SC)
	<b>EMISSIONS:</b> (Refer Emission Requirements Tab Section)
FE9	Federal Emission Requirement
NG1	Massachusetts/NY Emission Requirement
YF6	California Emission Requirement
N88	California Emission or NY/MA State Emission Override (Reqs FE9 Emission)
NC7	Federal Emission Override (Reqs YF6/NG1 Emission)
L36	<b>ENGINE:</b> 3.8 Liter SFI V6
B35	<b>FLOOR COVERING:</b> Mats, Carpeted Rear
AU0	<b>KEYLESS ENTRY:</b> Remote (Incl w/1SC) (Incls Theft Deterrent Alarm) (Reqs 1SB and AU3 Door Locks)
B84	<b>MOLDINGS:</b> Body Side, Color-keyed
Y87	<b>PERFORMANCE HANDLING PKG:</b> (Incls Limited Slip Axle, 4-Wheel Disc Brakes, Dual Outlet Exhaust and Sport Steering Ration) (Reqs 1SB or 1SC) (Reqs QCB & N96) (W/MX0 inclcs 3.42 Perf Axle)
	<b>RADIO EQUIPMENT:</b>
UL0	Electronically Tuned AM/FM Stereo Radio w/Seek-Scan, Digital Clock, Automatic Tone Control, Cassette Tape, Theft Lock and Speed Compensated Volume
UN0	Electronically Tuned AM/FM Stereo Radio w/Seek-Scan, Digital Clock, Automatic Tone Control, Compact Disc Player, Theft Lock and Speed Compensated Volume
U15	Remote CD Changer w/12 Disc Magazine (Reqs UL0 Radio)
CC1	<b>ROOF PANEL:</b> Transparent Removable (Incls Locks and Lockable Stowage Provisions and Special Black Roof and Mirror Treatment) (Incls Sunshade)
D82	<b>ROOF MONOCHROMATIC:</b> (Incls Body Colored Roof and Mirrors) (Reqs CC1 Roof Panel)
	<b>SEATS:</b>
AG1	Power (6-Way Driver)
AR9	Cloth Bucket
AR9	Leather Bucket
QCB	<b>TIRES:</b> P235/55 R16 B/W (Reqs N96 Wheels)
	<b>TRANSMISSIONS:</b>
MM5	5-Speed Manual (Base)
MX0	4-Speed Automatic, Electronically Controlled (Incls 2nd Gear Start) (W/1SA Reqs C60 Air)
N96	<b>WHEELS:</b> 16" Aluminum (Reqs QCB Tires)

**COLOR AND TRIM SELECTION**

PLEASE NOTE: The Exterior Paint and Interior Trim Combinations Shown Below are the Only Combinations that are Available.

Interior Trim Color		Dk Gray	Neutral	Med Gray	*Flame Red
MODEL	SEAT TYPE	**Seat Opt			
1FP87	Cloth Bucket	AR9	14B	52B	92B 73B
	Leather Seating Surface Bucket	AR9	142	522	

\*Flame Red on Door Trim and Seat Inserts only, with Graphite Accents  
 \*\*Seat Option AR9 Must Be Specified

**SOLID PAINT APPLICATION**

Exterior Paint Color	Color Code	Dk Gray	Neutral	Med Gray	Flame Red
Black	41U	x	x	x	x
Blue, Med Quasar (Met)	80U	x	x	x	
Green, Bright (Met)	31U	x	x	x	
Green, Polo (Met)	48U	x	x	x	
Purple, Bright (Met)	88U	x	x	x	
Red, Bright	81U	x	x	x	x
Red, Cavenne (Met)	96U	x	x	x	
Silver, Sebring (Met)	13U	x		x	x
Teal, Mystic (Met)	79U	x	x	x	
White, Arctic	10U	x	x	x	x

**POWER TEAMS**

ENGINE OPTION CONDITION	AXLES	
	3.23	3.08
L36 MX0#	--	Std
MM5	Std	--

#With Y87 Performance Handling Pkg Incls 3.42 Performance Axle

# CAMARO CONVERTIBLE MODEL 1FP67

\*Includes Destination & Handling Charges

**MUST SPECIFY: ENGINE, TRANSMISSION, EMISSIONS, TIRES  
MUST ORDER ONE GROUP -- NO DELETIONS ALLOWED**

	1SD	1SE	1SF
<b>Base Preferred Equipment Group</b> (Refer Standard Summary Page)	x	x	x
<b>Preferred Equipment Group 1</b>			
Power Door Lock System		x	x
Speed Control: Electronic, w/Resume Speed		x	x
Remote Trunk Release		x	x
Fog Lamps		x	x
<b>Preferred Equipment Group 2</b>			
Power Windows w/Driver's Side Express Down Feature			x
Mirrors Sport, Twin Remote Electric			x
Leather Wrapped Steering Wheel: w/Transmission Shifter, and Parking Brake Release Handle			x
Remote Keyless Entry w/Illuminated Interior Feature			x
Theft Deterrent Alarm System			x

## ADDITIONAL OPTIONS

### ACKNOWLEDGEMENTS

- R8S Multiple Order Numbers
- R8T Preliminary Invoice (Refer Vehicle Price Schedule)
- VK3 **BRACKET:** License Plate, Front
- EMISSIONS:** (Refer Emission Requirements Tab Section)
- FE9 Federal Emission Requirement
- NG1 Massachusetts/NY Emission Requirement
- YF5 California Emission Requirement
- NBB California Emission or NY/MA State Emissions Override (Reqs FE9 Emission)
- NC7 Federal Emission Override (Reqs YF5/NG1 Emission)
- L36 **ENGINE:** 3.8 Liter SFI V6
- B35 **FLOORING COVERING:** Mats, Rear
- AU0 **KEYLESS ENTRY:** Remote (Incls Theft Deterrent Alarm) (Incl w/1SF) (Reqs 1SE)
- B84 **MOLDINGS:** Body Side, Color-Keyed
- Y87 **PERFORMANCE HANDLING PKG:** (Incls Limited Slip Axle, 4-Wheel Disc Brakes, Dual Outlet Exhaust and Sport Steering Ratio) (Reqs 1SE or 1SF) (Reqs QCB Tires & N96 Wheels)(W/MX0  
Incls 3.42 Per Axle)
- RADIO EQUIPMENT:**
- UL0 Electronically Tuned AM/FM Stereo Radio w/Seek-Scan, Digital Clock, Automatic Tone Control, Cassette Tape, Theft Lock and Speed Compensated Volume
- UN0 Electronically Tuned AM/FM Stereo Radio w/Seek-Scan, Digital Clock, Automatic Tone Control, Compact Disc Player, Theft Lock and Speed Compensated Volume
- U1S Remote CD Changer w/12 Disc Magazine (Reqs UL0)
- SEATS:**
- AG1 Power, 6-Way Driver's Side
- AR9 Cloth Bucket
- AR9 Leather Bucket
- QCB **TIRES:** P235/55 R16 B/W (Reqs N96 Wheels)
- MM5 5-Speed Manual (Base)
- MX0 4-Speed Automatic, Electronically Controlled (Incls 2nd Gear Start)
- N96 **WHEELS:** 16" Aluminum (Reqs QCB Tires)



# CAMARO CONVERTIBLE

## COLOR AND TRIM SELECTION

**PLEASE NOTE:** The Exterior Paint and Interior Trim Combinations Shown Below are the Only Combinations that are Available.

Interior Trim Color		Dk Gray	Neutral	Med Gray	*Flame Red
MODEL	SEAT TYPE	**Seat Opt			
1FP67	Cloth Bucket	AR9	14B	52B	92B 73B
	Leather Seating Surface Bucket	AR9	142	522	

\*Flame Red on Door Trim and Seat Inserts only, with Graphite Accents  
 \*\*Seat Option AR9 Must Be Specified

## @CONVERTIBLE TOP AND PAINT SELECTOR

Exterior Paint Color	Color Code	Dk Gray	Neutral	Med Gray	Flame Red
Black	41U	10T/41T	41T/56T	10T/41T	10T/41T
Blue, Med Quasar (Met)	80U	10T/41T	56T	10T/41T	
Green, Bright (Met)	31U	10T/41T	56T	10T/41T	
Green, Polo (Met)	48U	10T/41T	56T	10T/41T	
Purple, Bright (Met)	88U	10T/41T	56T	10T/41T	
Red, Bright	81U	10T/41T	56T	10T/41T	10T/41T
Red, Cavenne (Met)	96U	10T/41T	56T	10T/41T	
Silver, Sebring (Met)	13U	10T/41T		10T/41T	10T/41T
Teal, Mystic (Met)	79U	10T/41T	56T	10T/41T	
White, Arctic	10U	10T/41T	10T/56T	10T/41T	10T/41T

@Convertible Top Option Must Be Specified in "Plus" (+) Option Section Of Order Worksheet

### CONVERTIBLE TOP COLOR

Arctic White..... 10T      Black ..... 41T      NEUTRAL.....56T

## POWER TEAMS

ENGINE OPTION CONDITION	AXLES	
	3.23	3.08
L36 MX0#	--	Std
MM5	Std	--

# With Y87 Performance Handling Pkg Incls 3.42 Perf Axle

# CAMARO RS COUPE MODEL 1FP87

\*Includes Destination & Handling Charges

**MUST SPECIFY: ENGINE, TRANSMISSION, EMISSIONS, TIRES**  
**MUST ORDER ONE GROUP -- NO DELETIONS ALLOWED**

	1SN	1SP	1SQ
<b>Base Preferred Equipment Group</b> (Refer Standard Summary Page)	x	x	x
<b>Preferred Equipment Group 1</b>			
Power Door Lock System		x	x
Speed Control: Electronic, w/Resume Speed		x	x
Remote Hatch Release		x	x
Fog Lamps		x	x
<b>Preferred Equipment Group 2</b>			
Power Windows w/Driver's Side Express Down Feature			x
Mirrors, Sport Twin Remote Electric			x
Leather Wrapped Steering Wheel: w/Transmission Shifter, and Parking Brake Release Handle			x
Remote Keyless Entry w/Illuminated Interior Feature			x
Theft Deterrent Alarm System			x

## ADDITIONAL OPTIONS

### ACKNOWLEDGEMENTS:

- R8S Multiple Order Numbers
- R8T Preliminary Invoice (Refer Vehicle Price Schedule)
- VK3 **BRACKET:** License Plate, Front

### DEFOGGER (Note: One of the Following must be Specified)

- C49 Rear Window, Electric
- R9W Rear Window not Desired

### EMISSIONS: (Refer Emission Requirements Tab Section)

- FE9 Federal Emission Requirement
- NG1 Massachusetts/NY Emission Requirement
- YF5 California Emission Requirement
- NB8 California Emission or NY/MA State Emissions Override (Reqs FE9 Emission)
- NC7 Federal Emission Override (Reqs YF5/NG1 Emission)

### ENGINE:

- L36 3.8 Liter SFI V6

- B35 **FLOOR COVERING:** Mats, Carpeted Rear

- B84 **MOLDINGS:** Body Side, Color-Keyed

- AU0 **KEYLESS ENTRY:** Remote (Incls Theft Deterrent Alarm) (Incl w/1SQ) (Reqs 1SP)

- Y87 **PERFORMANCE HANDLING PKG:** (Incls Limited Slip Axle, 4-Wheel Disc Brakes, Dual Outlet Exhaust and Sport Steering Ratio) (Reqs 1SP or 1SQ) (W/MXO Incls 3.42 Perf Axle)

### RADIO EQUIPMENT:

- UL0 Electronically Tuned AM/FM Stereo Radio w/Seek-Scan, Digital Clock, Automatic Tone Control, Cassette Tape, Theft Lock and Speed Compensated Volume

- UN0 Electronically Tuned AM/FM Stereo Radio w/Seek-Scan, Digital Clock, Automatic Tone Control, Compact Disc Player, Theft Lock and Speed Compensated Volume

- U1S Remote CD Changer w/12 Disc Magazine (Reqs UL0)

- CC1 **ROOF PANEL:** Transparent Removable (Incls Locks and Lockable Stowage Provisions and Special Black Roof and Mirror Treatment) (Incls Sunshade)

- D82 **ROOF MONOCHROMATIC:** (Incls Body Colored Roof and Mirrors) (Reqs CC1 Roof Panel)

### SEATS:

- AG1 Power (6-Way Driver)
- AR9 Cloth Bucket
- AR9 Leather Bucket

### TRANSMISSIONS:

- MM5 5-Speed Manual (Base)
- MX0 4-Speed Automatic, Electronically Controlled (Incls 2nd Gear start)

- N98 **WHEEL:** Chrome Aluminum 16"

# CAMARO RS COUPE

## COLOR AND TRIM SELECTION

**PLEASE NOTE:** The Exterior Paint and Interior Trim Combinations Shown Below are the Only Combinations that are Available.

Interior Trim Color		Dk Gray	Neutral	Med Gray	*Flame Red	
MODEL	SEAT TYPE	**Seat Opt				
1FP87	Cloth Bucket	AR9	14B	52B	92B	73B
	Leather Seating Surface Bucket	AR9	142	522		

\*Flame Red on Door Trim and Seat Inserts only, with Graphite Accents

\*\*Seat Option AR9 Must Be Specified

## SOLID PAINT APPLICATION

Exterior Paint Color	Color Code	Dk Gray	Neutral	Med Gray	Flame Red
Black	41U	x	x	x	x
Green, Bright (Met)	31U	x	x	x	
Purple, Bright (Met)	88U	x	x	x	
Red, Bright	81U	x	x	x	x
Silver, Sebring (Met)	13U	x		x	x
White, Arctic	10U	x	x	x	x

## POWER TEAMS

ENGINE OPTION CONDITION	AXLES	
	3.23	3.08
L36 MX0#	--	Std
MM5	Std	--

#With Y87 Performance Handling Pkg Incl 3.42 Performance Axle

# CAMARO RS CONVERTIBLE MODEL 1FP67

\*Includes Destination and Handling Charges

**MUST SPECIFY: ENGINE, TRANSMISSION, EMISSIONS, TIRES**

**MUST ORDER ONE GROUP -- NO DELETIONS ALLOWED**

	1SR	1SS	1ST
<b>Base Preferred Equipment Group</b> (Refer Standard Summary Page)	x	x	x
<b>Preferred Equipment Group 1</b>			
Power Door Lock System		x	x
Speed Control: Electronic, w/Resume Speed		x	x
Remote Trunk Release		x	x
Fog Lamps		x	x
<b>Preferred Equipment Group 2</b>			
Power Windows w/Driver's Side Express Down Feature			x
Mirrors Sport, Twin Remote Electric			x
Leather Wrapped Steering Wheel: w/Transmission Shifter, and Parking Brake Release Handle			x
Remote Keyless Entry w/Illuminated Interior Feature			x
Theft Deterrent Alarm System			x

## ADDITIONAL OPTIONS

### ACKNOWLEDGEMENTS:

- R8S Multiple Order Numbers
- R8T Preliminary Invoice (Refer Vehicle Price Schedule)
- VK3 **BRACKET:** License Plate, Front

### EMISSIONS: (Refer Emission Requirements Tab Section)

- FE9 Federal Emission Requirement
- NG1 Massachusetts/NY Emission Requirement
- YF5 California Emission Requirement
- NB8 California Emission or NY MA State Emissions Override (Reqs FE9 Emission)
- NC7 Federal Emission Override (Reqs YF5/NG1 Emission)

### ENGINE:

- L36 3.8 Liter SFI V6
- B35 **FLOORING COVERING:** Mats, Carpeted, Rear
- B84 **MOLDINGS:** Body Side, Color-Keyed
- AU0 **KEYLESS ENTRY:** Remote (Incls Theft Deterrent Alarm) (Incl w/1ST) (Reqs 1SS)
- Y87 **PERFORMANCE HANDLING PKG:** (Incls Limited Slip Axle, 4-Wheel Disc Brakes, Dual Outlet Exhaust and Sport Steering Ratio) (Reqs 1SS or 1ST) (W/MX0 Incls 3.42 Perf Axle)

### RADIO EQUIPMENT:

- UL0 Electronically Tuned AM/FM Stereo Radio, w/Seek-Scan, Digital Clock, Automatic Tone Control, Cassette Tape, Theft Lock and Speed Compensated Volume
- UN0 Electronically Tuned AM/FM Stereo Radio w/seek-Scan, Digital Clock, Automatic Tone Control, Compact Disc Player, Theft Lock and Speed Compensated Volume
- U1S Remote CD Changer w/12 Disc Magazine (Reqs UL0)

### SEATS:

- AG1 Power, 6-Way Driver's Side
- AR9 Cloth Bucket
- AR9 Leather Bucket

### TRANSMISSIONS:

- MM5 5-Speed Manual (Base)
- MX0 4-Speed Automatic, Electronically Controlled (Incls 2nd Gear Start)
- N98 **WHEEL:** Chrome Aluminum 16"

# CAMARO RS CONVERTIBLE

## COLOR AND TRIM SELECTION

**PLEASE NOTE:** The Exterior Paint and Interior Trim Combinations Shown Below are the Only Combinations that are

Interior Trim Color		Dk Gray	Neutral	Med Gray	*Flame Red
MODEL	SEAT TYPE	**Seat Opt			
1FP67	Cloth Bucket	AR9	14B	52B	92B 73B
	Leather Seating Surface Bucket	AR9	142	522	

\*Flame Red on Door Trim and Seat Inserts only, with Graphite Accents  
 \*\*Seat Option AR9 Must Be Specified

## @CONVERTIBLE TOP AND PAINT SELECTOR

Exterior Paint Color	Color Code	Dk Gray	Neutral	Med Gray	Flame Red
Black	41U	10T/41T	41T/56T	10T/41T	10T/41T
Green, Bright (Met)	31U	10T/41T	56T	10T/41T	
Purple, Bright (Met)	88U	10T/41T	56T	10T/41T	
Red, Bright	81U	10T/41T	56T	10T/41T	10T/41T
Silver, Sebring (Met)	13U	10T/41T		10T/41T	10T/41T
White, Arctic	10U	10T/41T	10T/56T	10T/41T	10T/41T

@Convertible Top Option Must Be Specified in "Plus" (+) Option Section Of Order Worksheet

## CONVERTIBLE TOP COLOR

Arctic White..... 10T      Black ..... 41T      NEUTRAL.....56T

## POWER TEAMS

ENGINE OPTION CONDITION	AXLES	
	3.23	3.08
L36 MX0#	--	Std
MM5	Std	--

# With Y87 Performance Handling Pkg Incis 3.42 Perf Axle

# CAMARO Z28 COUPE MODEL 1FP87

\*Includes Destination & Handling Charges

**MUST SPECIFY: ENGINE, TRANSMISSION, EMISSIONS  
MUST ORDER ONE GROUP -- NO DELETIONS ALLOWED**

Base Preferred Equipment Group (Refer Standard Summary Page)	1SG	1SH	1SJ
	x	x	x
<b>Preferred Equipment Group 1</b>			
Power Door Locks		x	x
Speed Control: Electronic, w/Resume Speed		x	x
Remote Hatch Release		x	x
Fog Lamps		x	x
4-Way Manual Seat Adjuster		x	x
<b>Preferred Equipment Group 2</b>			
Power Windows w/Driver's Side Express Down Feature			x
Mirrors Sport, Twin Remote Electric			x
Leather Wrapped Steering Wheel: w/Transmission Shifter, and Parking Brake Release Handle			x
Remote Keyless Entry w/Illuminated Interior Feature			x
Theft Deterrent Alarm System			x

## ADDITIONAL OPTIONS

NW9	<b>ACCELERATION SLIP REGULATION:</b> N/A 1SG) (QFZ Tires Recommended For Optimum Traction)
	<b>ACKNOWLEDGEMENTS:</b>
R8S	Multiple Order Numbers
R8T	Preliminary Invoice (Refer Vehicle Price Schedule)
GU5	<b>AXLE:</b> Performance (Reqs MX0 Trans and QLC or QFZ Tires)
VK3	<b>BRACKET:</b> License Plate, Front
	<b>DEFOGGER: (Note: One of the Following Options must be Specified)</b>
C49	Rear Window, Electric
R9W	Rear Window not Desired
	<b>EMISSIONS: (Refer Emission Requirements Tab Section)</b>
FE9	Federal Emission Requirement
NG1	Massachusetts/NY Emission
YF5	California Emission Requirement
NB8	California Emission or NY/MA State Emission Override (Reqs FE9 Emission)
NC7	Federal Emission Override (Reqs YF5/NG1 Emission)
LT1	<b>ENGINE:</b> 5.7 Liter SFI V8 (Base)
B35	<b>FLOOR COVERING:</b> Mats, Carpeted Rear
AU0	<b>KEYLESS ENTRY:</b> Remote (Incls Theft Deterrent System) (Incl w/1SJ) (Reqs 1SH)
B84	<b>MOLDINGS:</b> Body Side, Color-Keyed
1LE	<b>PERFORMANCE PACKAGE:</b> (Incls Special Handling Suspension System Including Larger Stabilizer Bars, Stiffer Springs, Dual Adjustable Shock Absorbers and Bushings) (Reqs 1SG and QLC Tires) (With MX0 Trans Reqs GU5 Axle) (N/A AG1 Power Seat or CC1 Roof Panels) (Intended for Serious Performance Enthusiasts Only)
CC1	<b>ROOF PANELS:</b> Transparent Removable (Incls Locks and Lockable Storage Provisions) (Incls Sunshade)
D82	<b>ROOF, MONOCHROMATIC:</b> (Replaces Special Black Roof w/Body Color Roof and Mirrors)
	<b>RADIO EQUIPMENT:</b>
U00	Electronically Tuned AM/FM Stereo Radio w/Seek-Scan, Digital Clock, Automatic Tone Control, Cassette Tape, Theft Lock and Speed Compensated Volume
JN0	Electronically Tuned AM/FM Stereo Radio w/Seek-Scan, Digital Clock, Automatic Tone Control, Compact Disc Player and Speed Compensated Volume
C1S	Remote CD Changer w/12 Disc Magazine (Reqs U00)
	<b>SEATS:</b>
AG1	Power (6-Way Driver) (N/A 1SG)
AR9	Cloth Bucket
AR9	Leather Bucket

## CAMARO Z28 COUPE

### ADDITIONAL OPTIONS CONT'D

#### TIRES:

QFZ P245/50 ZR16 B/W All Season Performance  
QLC P245/50 ZR16 B/W Performance

#### TRANSMISSION

MN6 6-Speed Manual (Base) (Incls Performance Axle)

MX0 4-Speed Automatic, Electronically Controlled

N98 WHEEL: Chrome Aluminum 16"

Z4C 30TH ANNIVERSARY EDITION: (Incls White Monochromatic Exterior w/Orange Stripes, White 5-Spoke Aluminum Wheels, 30th Anniversary Embroidered Emblems on Front Floor Mats and Headrests (Reqs 1SJ and QFZ or QLC Tires) (Reqs AG1)

# CAMARO Z28 COUPE

## COLOR AND TRIM SELECTION (N/A w/Z4C)

**PLEASE NOTE:** The Exterior Paint and Interior Trim Combinations Shown Below are the Only Combinations that are Available.

Interior Trim Color		Dk Gray	Neutral	Med Gray	*Flame Red
MODEL	SEAT TYPE	**Seat Opt			
1FP87	Cloth Bucket	AR9	14B	52B	92B 73B
	\$Leather Bucket	AR9	142	522	

- \*Flame Red on Door Trim and Seat Inserts only, with Graphite Accents
- \*\*Seat Option AR9 Must Be Specified
- ‡ Leather N/A 1SG Peg

## SOLID PAINT APPLICATION (N/A w/Z4C)

Exterior Paint Color	Color Code	Dk Gray	Neutral	Med Gray	Flame Red
Black	41U	x	x	x	x
Blue, Med Quasar (Met)	80U	x	x	x	
Green, Bright (Met)	31U	x	x	x	
Green, Polo (Met)	48U	x	x	x	
Purple, Bright (Met)	88U	x	x	x	
Red, Bright	81U	x	x	x	x
Red, Cayenne (Met)	96U	x	x	x	
Silver, Sebring (Met)	13U	x		x	x
Teal, Mystic (Met)	79U	x	x	x	
White, Arctic	10U	x	x	x	x

## POWER TEAMS

ENGINE OPTION CONDITION	AXLE RATIO		
	2.73	3.23	3.42
LT1 MN6	---	---	Sta
MX0	Std	GU5	---

## COLOR AND TRIM SELECTION (W/ Z4C)

**PLEASE NOTE:** The Exterior Paint and Interior Trim Combinations Shown Below are the Only Combinations that are Available.

30TH ANNIVERSARY EDITION		Arctic White Seats w/Houndstooth Cloth Inserts	Arctic White Seat w/ Leather Seating Surfaces
MODEL	SEAT TYPE	Seat Opt	
1FP87	Cloth Bucket	AR9	10C
	Leather Bucket	AR9	103

## SOLID PAINT APPLICATION (W/Z4C)

Exterior Paint Color	Color Code		
White, Arctic	10U	x	x



# CAMARO Z28 CONVERTIBLE MODEL 1FP67

\*Includes Destination & Handling Charges

**MUST SPECIFY: ENGINE, TRANSMISSION, EMISSIONS, TIRES  
MUST ORDER ONE GROUP -- NO DELETIONS ALLOWED**

Base Preferred Equipment Group (Refer Standard Summary Page)	1SK	1SL	1SM
	x	x	x
<b>Preferred Equipment Group 1</b>			
Power Door Locks		x	x
Speed Control: Electronic, w/Resume Speed		x	x
Remote Trunk Release		x	x
Fog Lamps		x	x
<b>Preferred Equipment Group 2</b>			
Power Windows w/Driver's Side Express Down Feature			x
Mirrors Sport, Twin Remote Electric			x
Leather Wrapped Steering Wheel: Transmission Shifter, and Parking Brake Release Handle			x
Remote Keyless Entry w/Illuminated Interior Feature			x
Theft Deterrent Alarm System			x

## ADDITIONAL OPTIONS

- NW9 ACCELERATION SLIP REGULATION:** (QFZ Tires Recommended for Optimum Traction)  
(N/A 1SK)
- ACKNOWLEDGEMENTS:**
- R8S Multiple Order Numbers
- R8T Preliminary Invoice (Refer Vehicle Price Schedule)
- GU5 **AXLE:** Performance (Reqs MX0 Trans and QLC or QFZ Tires)
- VK3 **BRACKET:** License Plate, Front
- EMISSIONS: (Refer Emission Requirements Tab Section)**
- FE9 Federal Emission Requirement
- NG1 Massachusetts/NY Emission Requirement
- YF5 California Emission Requirement
- NB8 California Emission or NY/MA State Emission Override (Reqs FE9 Emission)
- NC7 Federal Emission Override (Reqs YF5/NG1 Emission)
- LT1 **ENGINE:** 5.7 Liter SFI V8
- B35 **FLOOR COVERING:** Mats, Carpeted Rear
- B84 **MOLDINGS:** Body Side, Color Keyed
- AU0 **KEYLESS ENTRY:** Remote (Incls Theft Deterrent Alarm) (Incl w/1SM) (Reqs 1SL)
- RADIO EQUIPMENT:**
- UL0 Electronically Tuned AM/FM Stereo Radio w/Seek-Scan, Digital Clock, Automatic Tone Control, Cassette Tape, Theft Lock and Speed Compensated Volume
- UN0 Electronically Tuned AM/FM Stereo Radio w/Seek-Scan, Digital Clock, Automatic Tone Control, Compact Disc Player, Theft Lock and Speed Compensated Volume
- U1S Remote CD Changer w/12 Disc Magazine (Reqs UL0)
- SEATS:**
- AG1 Power (6-Way Driver)
- AR9 Cloth Bucket
- AR9 Leather Bucket
- TIRES:**
- QFZ P245/50 ZR16 B/W All Season Performance
- QLC P245/50 ZR16 B/W Performance
- TRANSMISSION**
- MN6 6-Speed Manual (Base) (Incls Performance Axle)
- MX0 4-Speed Automatic, Electronically Controlled
- N98 **WHEELS:** Chrome Aluminum 16"
- Z4C **30TH ANNIVERSARY EDITION:** (Incls White Monochromatic Exterior w/Orange Stripes, White 5-Spoke Aluminum Wheels, 30th Anniversary Embroidered Emblems on Front Floor Mats and Headrests (Reqs 1SM and QFZ or QLC Tires)(Reqs AG1)

## CAMARO Z28 CONVERTIBLE

### COLOR AND TRIM SELECTION (N/A w/Z4C)

**PLEASE NOTE:** The Exterior Paint and Interior Trim Combinations Shown Below are the Only Combinations that are Available.

Interior Trim Color		Dk Gray	Neutral	Med Gray	*Flame Red	
MODEL	SEAT TYPE	**SEAT OPTION				
1FP67	Cloth Bucket	AR9	14B	52B	92B	73B
	Leather Seating Surface Bucket	AR9	142	522		

\*Flame Red on Door Trim and Seat Inserts only, with Graphite Accents

\*\*Seat Option AR9 Must Be Specified

### @CONVERTIBLE TOP AND PAINT SELECTOR (N/A w/Z4C)

Exterior Paint Color	Color Code	Dk Gray	Neutral	Med Gray	Flame Red
Black	41U	10T/41T	41T/56T	10T/41T	10T/41T
Blue, Med Quasar(Met)	80U	10T/41T	56T	10T/41T	
Green, Bright (Met)	31U	10T/41T	56T	10T/41T	
Green, Polo (Met)	48U	10T/41T	56T	10T/41T	
Purple, Bright (Met)	88U	10T/41T	56T	10T/41T	
Red, Bright	81U	10T/41T	56T	10T/41T	10T/41T
Red,Cayenne (Met)	96U	10T/41T	56T	10T/41T	
Silver, Sebring (Met)	13U	10T/41T		10T/41T	10T/41T
Teal, Mystic (Met)	79U	10T/41T	56T	10T/41T	
White, Arctic	10U	10T/41T	10T/56T	10T/41T	10T/41T

@Convertible Top Option Must Be Specified in "Plus" (+) Option Section Of Order Worksheet

#### CONVERTIBLE TOP COLOR

Arctic White..... 10T

Black ..... 41T

Neutral.....56T

### POWER TEAMS

ENGINE OPTION CONDITION	AXLE RATIO		
	2.73	3.23	3.42
LT1 MN6	---	---	Std
MX0	Std	GU5	---

### COLOR AND TRIM SELECTION (W/ Z4C)

**PLEASE NOTE:** The Exterior Paint and Interior Trim Combinations Shown Below are the Only Combinations that are Available.

30TH ANNIVERSARY EDITION		Arctic White Seats w/Houndstooth Cloth Inserts	Arctic White Seats w/Leather Seating Surfaces
MODEL	SEAT TYPE	Seat Opt	
1FP67	Cloth Bucket	AR9	10C
	Leather Bucket	AR9	103

### SOLID PAINT APPLICATION (W/Z4C)

Exterior Paint Color	Color Code		
White, Arctic	10U	10T	10T

**Opti-spark** - The LT1 features an angle-based opti-spark system — the highest precision spark control and delivery system available. That's because it reads cylinder positions at every degree of crank rotation, enabling spark-control adjustments to be accomplished several times each second.

**Exhaust manifold** - The LT1's exhaust manifold has single-point air injection and an electric air pump, thereby eliminating unnecessary parasitic loss experienced with mechanical systems. This extremely quiet air pump is especially helpful during cold starts for better catalytic converter efficiency. The exhaust manifold features tri-layered stainless steel gaskets. This improves the durability of the gaskets over time and helps the system meet GM's exhaust leakage specifications. The F-car's exhaust manifold and converters help it to meet the strict California emissions standards — the toughest in the country. In fact, every F-car produced contains all the technologies needed to pass California emissions requirements, making it truly a "50-state car."

**Copper lead bearings** - The LT1 features copper lead cam bearings. The copper replaced the former cadmium lead bearings. This removes the environmentally unfriendly material from the manufacturing site, and enables the copper to be recycled.

**Other key features** - The 5.7L V8 LT1 offers many distinctive features that have earned it a clear market niche. This includes a gear-driven water pump that helps ensure coolant flow, even in the event of accessory belt breakage. Dual-oxygen sensors and knock sensors, coupled with accurate Multec fuel injectors and opti-spark, provide optimum control for each cylinder bank. LT1 also features powdered-metal connecting rods and positively ventilated angle-based ignition timing for improved reliability.

**Continuous improvement** - Throughout its life, the LT1 has received improvements in reliability and serviceability, such as an upgraded oil pan, oil-level sensor, coolant pump and single-speed electric fuel pump. In the spirit of continuous improvement, new composite rocker arm covers were added to absorb more engine noise and vibration. A 5-degree throttle improve launch feel and gives smoother transitions off the line. The pistons in the LT1 feature a positive twist top ring design. This improves the seal between piston and cylinder bore, and reduces blow-by emissions, particularly at high engine speeds. The LT1 engine uses long life coolant.

**Range extension** - The range extension of the LT1 has raised the level of competition for all large displacement sport and passenger car engines because it delivers the character that all customers want. Its design integrity is evidenced by the outstanding customer response we have had since its introduction. The LT1 has power at a broad range of engine speeds, a lively, responsive throttle and outstanding fuel efficiency.

# 5.7L V8

## LT1

---

### Features and Benefits

**Sequential-port fuel injection** - The 5.7L V8 features sequential port fuel injection (SFI), the most sophisticated and advanced fuel delivery technology Powertrain offers. This is a very precise fuel delivery system in which the powertrain control module (PCM) individually controls the fuel injectors. With SFI, each of the eight injectors are fired one at a time, in a sequence that matches the firing order, further improving fuel timing for optimum combustion. SFI offers greater emissions control, idle stability, performance, durability, fuel efficiency and driveability.

**On-Board Diagnostics Second Generation (OBDII)** - As with all GM vehicles, the LT1 became fully OBDII compliant in 1996. The PCM, a highly sophisticated on-board computer and one of the industry's most powerful, must now monitor a wide variety of emissions systems and components for the slightest level of deterioration or malfunction. This includes the fuel delivery system, catalytic converter and EGR valve. Its diagnostic tools include the oxygen sensor, crank position sensor, MAP sensor and manifold air temperature sensor. These systems have secondary benefits, as well. Rear oxygen sensors, for example, help improve fuel control and overall performance. In addition to ensuring vehicles meet the more stringent emissions standards and improving overall system reliability, OBDII has some benefits for the customer. The PCM stores and retrieves even more diagnostic messages to help technicians diagnose and fix problems more quickly and accurately. And since OBDII sets trouble codes (SERVICE ENGINE SOON light), when a system begins to deteriorate rather than waiting for a complete system failure, drivers can bring their vehicles in for service before experiencing a possible break down or more costly repair.

**Powertrain control module** - Coupled with SFI, the LT1's powertrain control module (PCM) controls the individual fuel injectors and optical ignition system, and interacts with the electronically controlled transmission.

**Ignition system** - The LT1's powerful ignition system was enhanced in 1996. Customers will notice improved idle quality thanks to new low-resistance wires and new spark plugs. This high current, low resistance system offers cold-start performance unsurpassed by today's competition. Even in temperatures as cold as 20 degrees below zero, the LT1 starts every time within six-tenths of one second.

**The legend lives on** - This legendary small-block V8 packs enormous power and responsiveness into an efficient package. The engine — a radical re-design of GM's historical 350 CID V8 — represents the future of General Motors overhead valve (OHV) engines. RPM range is increased 800 to 1000 revs beyond most OHV engines, giving the LT1 the low-end punch of an OHV and the high-speed responsiveness of an overhead cam engine. This "best of both worlds" characteristic of the LT1 makes it perfect for sport performance models.

**There's more than just brawn** - Power isn't the only attribute of the LT1. It leads the entire spectrum of engine attributes with an unrivaled degree of balanced excellence. Fuel efficiency, strict emissions compliance, system durability, performance and attention to hardware detail add up to one great engine.

## Product Specifications

**Type:**  
5.7L V8

**Displacement:**  
5733 cc (350 CID)

**Compression Ratio:**  
10.4:1

**Valve Configuration:**  
OVERHEAD VALVES

**Assembly Site:**  
FLINT, MI

**Valve Lifters:**  
HYDRAULIC ROLLER

**Firing Order:**  
1 - 8 - 4 - 3 - 6 - 5 - 7 - 2

**Bore x Stroke:**  
101.60 x 88.39 mm (4.00 x 3.48 in)

**Fuel System:**  
SEQUENTIAL PORT  
FUEL INJECTION

**Horsepower:**  
285 @ 5000 rpm

**Torque (lb-ft):**  
325 @ 2400 rpm

**Maximum Engine Speed:**  
6000 rpm

**Emissions Control:**

- EVAPORATIVE
- CATALYTIC CONVERTER
- EXHAUST GAS RECIRCULATION (EGR)
- POSITIVE CRANKCASE VENTILATION (PCV)
- AIR INJECTION REACTION (AIR)

### Materials

**Block:**  
CAST IRON

**Cylinder Head:**  
CAST ALUMINUM

**Intake Manifold:**  
CAST ALUMINUM

**Exhaust Manifold:**  
HIGH SILICON MOLYBDENUM  
CAST NODULAR IRON

**Main Bearing Caps:**  
CAST IRON

**Crankshaft:**  
CAST IRON

**Camshaft:**  
STEEL

**Connecting Rods:**  
POWDERED METAL

**Additional Features:**  
EXTENDED LIFE SPARK PLUGS  
EXTENDED LIFE COOLANT  
OIL LEVEL SENSOR

**Applications:**  
Chevrolet Camaro - option  
Pontiac Firebird - option

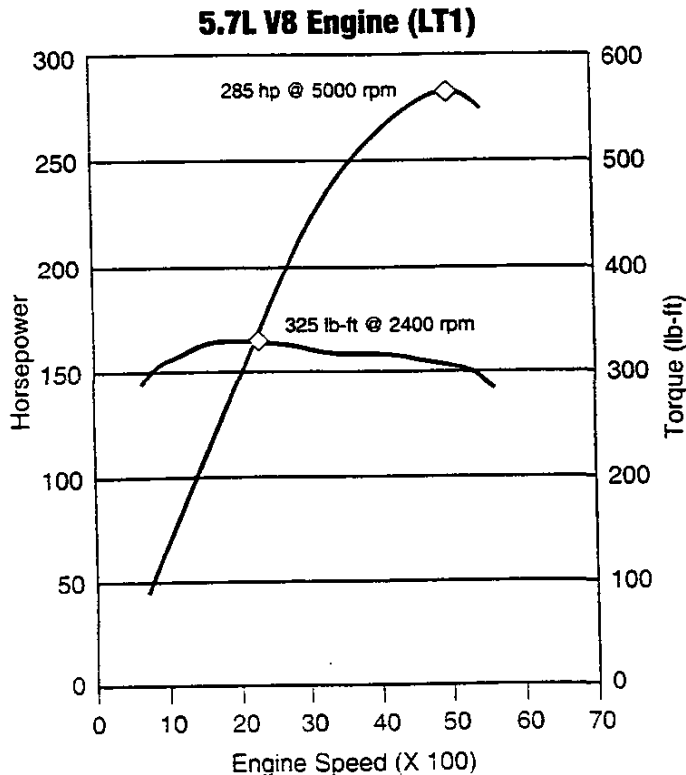

*Information may vary with application. All specifications listed are based on the latest product information available at the time of publication. The right is reserved to make changes at any time without notice.*

CHEVROLET/PONTIAC

# 5.7L V8

LT1

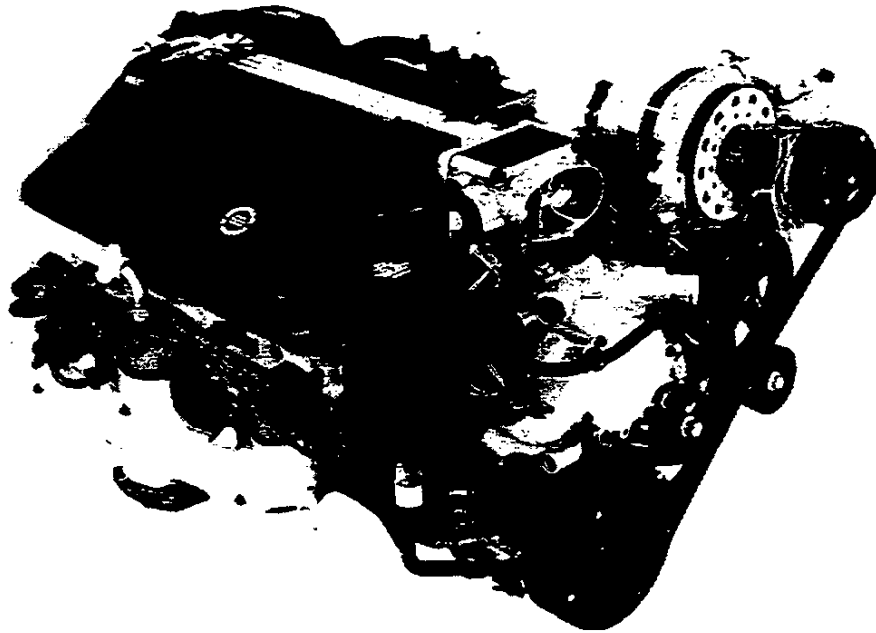

Y-car Version Shown



*"...the second generation LT1 packs impressive performance and responsiveness into an efficient package. The useful operating range extends hundreds of rpm beyond most overhead valve engines. The LT1 offers the best of both worlds, it has the speed punch of a traditional two-valve pushrod engine and the high-speed performance of a multi-valve overhead cam design."*

A. E. Marsocci  
Auto Weekly

**Oil pan, seals are "noisebusters"** - The 3800 Series II oil pan is laminated to reduce noise. In addition, design for manufacturing principles led to development of a oil pan gasket and integrated oil pan baffle, as well as a rear crankshaft seal carrier. These Design for Manufacturability or DFM initiatives not only improve sealing and eliminate plugs, but noise character and durability is improved as well.

**Improved air management** - The composite (glass-reinforced nylon) intake manifold and air induction system provides a more linear acceleration curve.

**Direct accessory mounting reduces noise, vibration** - The power steering pump, alternator bracket, and other brackets and tensioners are direct-mounted for simplicity, manufacturability and improved vibration characteristics.

**Quiet exhaust system** - Exhaust noise is reduced through the use of a cast-iron left manifold, insulated cross-over pipe, and air gap take-down pipe. Casting manufacturing technology and engine fuel control allow the cast iron manifold to provide quieter operation and better value. To ensure emissions performance and quicker light-off, the right manifold remains sheet metal. Heat shielding of the exhaust system compartment is minimized to reduce radiated exhaust noise.

**Throttle body** - High air flow is achieved through the use of a large inlet throttle body. A progressive cam and cable linkage also is used for a linear throttle feel. Customers will notice better feel throughout the driving range in this tuned-for-performance throttle body.

**Oil filling** - Adding engine oil is clean and easy with the extended oil-filling cap.

**Dual-function coolant sensor** - The Series II high-tech coolant sensor drives both the PCM coolant gage and the instrument panel gage for greater precision.

**TLEV Compliant** - All L36 applications have also been engineered so that, when properly configured, they will meet the more stringent California TLEV emission standards.

**Technological Innovation Recognition** - The editors and readers of *Automotive Engineering* magazine selected the 3800 Series II engine as one of the "Top 15 Technological Innovations" stories of 1995.

# 3.8L V6

## L36

---

### Features and Benefits



**Engine Sealing** - Sealing has been upgraded with a totally redesigned front/rear intake to cylinder block end seal.

**Ward's again rates 3800 Series II "best"** - Ward's Auto World magazine rated the 3800 Series II V6 one of the "ten best engines" for a wide variety of operating characteristics, including NVH, performance and fuel economy. The 1996 award was the second consecutive honor for the L36 in the Ward's competition.

**On-board diagnostics system (OBDII)** - As with all GM engines produced for North American applications, the L36 is fully OBDII compliant. This required significant enhancements to the powertrain control module (PCM). The PCM must now monitor a wide variety of emissions systems and components for the slightest level of deterioration or malfunction. OBDII does benefit the customer. The PCM stores and retrieves diagnostic messages to help technicians fix problems more quickly and accurately. And since OBDII sets trouble codes (SERVICE ENGINE SOON light), when a system begins to deteriorate rather than waiting for a complete system failure, owners can bring their vehicles in for service before experiencing a possible breakdown or more costly repair. Significant improvements to exhaust system sealing were made to meet even more stringent 1997 OBDII requirements. A major change was made in the use of a flexible joint between the down pipe and the catalytic converter.

**Platinum plugs deliver durability** - Dual platinum-tipped spark plugs, together with sophisticated electronic ignition and fuel management systems provide maintenance-free durability. First scheduled spark plug change is at 100,000 miles.

**Lightweight Piston Boosts Power** - The 3800 Series II features a floating-pin piston design to further reduce friction and mass. These lightweight pistons provide for higher horsepower than the first generation of 3800 V6 and increased compression ratio.

**Lightweight, high-performance valve train** - The valve train has been redesigned to allow the engine to perform up to 5800 rpm (compared with 5200 rpm on the first generation of 3800 V6) with a 6000 rpm redline. This provides more rpm extension than competitive pushrods on the market and is competitive with dual overhead cam offerings. Lighter weight valves, springs, and spring caps contribute to increased mechanical stiffness, allowing higher rpm capability and increased horsepower.

**Symmetrical combustion = cleaner engine** - The cylinder head features symmetrical ports and combustion chambers to reduce combustion variability by providing uniform combustion in all six cylinders, improving emissions.

**Compression ratio** - The L36 3800 Series II engine has a compression ratio of 9.4:1, which is one of the highest of any V6 pushrod on the market today. Comparable to dual overhead cam engines, this higher ratio is enabled by dual electronic spark control (ESC) or knock sensors and combustion chamber design. Dual ESC sensors allow knock to be "heard" from all cylinders.



### Product Specifications

**Type:**  
3.8L V6

**Displacement:**  
3791 cc (231 CID)

**Compression Ratio:**  
9.4:1

**Valve Configuration:**  
OVERHEAD VALVES

**Assembly Site:**  
FLINT, MI

**Valve Lifters:**  
HYDRAULIC ROLLER

**Firing Order:**  
1-6-5-4-3-2

**Bore x Stroke:**  
96.52 x 86.36 mm (3.80 x 3.40 in)

**Fuel System:**  
SEQUENTIAL FUEL INJECTION

**Horsepower:**  
205 @ 5200 rpm (C, G, H)  
200 @ 5200 rpm (F)  
195 @ 5200 rpm (W)

**Torque (lb-ft):**  
230 @ 4000 rpm (C, G, H)  
225 @ 4000 rpm (F)  
220 @ 4000 rpm (W)

**Maximum Engine Speed:**  
6000 rpm

**Emissions Control:**

- EVAPORATIVE
- CATALYTIC CONVERTER
- EXHAUST GAS RECIRCULATION (EGR)
- POSITIVE CRANKCASE VENTILATION (PCV)

### Materials

**Block:**  
CAST IRON

**Cylinder Head:**  
CAST IRON

**Intake Manifold:**  
CAST ALUMINUM - LOWER  
COMPOSITE - UPPER (C,G,H,W)  
CAST ALUMINUM - UPPER (F)

**Exhaust Manifold:**  
HIGH SILICON MOLYBDENUM  
CAST NODULAR IRON (F)

HIGH SILICON MOLYBDENUM  
CAST NODULAR IRON (LEFT W)

CAST NODULAR IRON  
(RIGHT-C,G,H,W)

STAINLESS STEEL (LEFT-C,G,H)

**Main Bearing Caps:**  
POWDERED METAL

**Crankshaft:**  
CAST IRON

**Camshaft:**  
STEEL

**Additional Features:**  
EXTENDED LIFE SPARK PLUGS  
EXTENDED LIFE COOLANT  
OIL LEVEL SENSOR

**Applications:**  
Buick LeSabre - base  
Buick Park Avenue - base  
Buick Regal - base  
Buick Riviera - base  
Chevrolet Camaro - base  
Oldsmobile Eighty Eight - base  
Pontiac Bonneville - base  
Pontiac Firebird - base  
Pontiac Grand Prix - option

Information may vary with application. All specifications listed are based on the latest product information available at the time of publication. The right is reserved to make changes at any time without notice.

**"3800 Series II" (L36)**

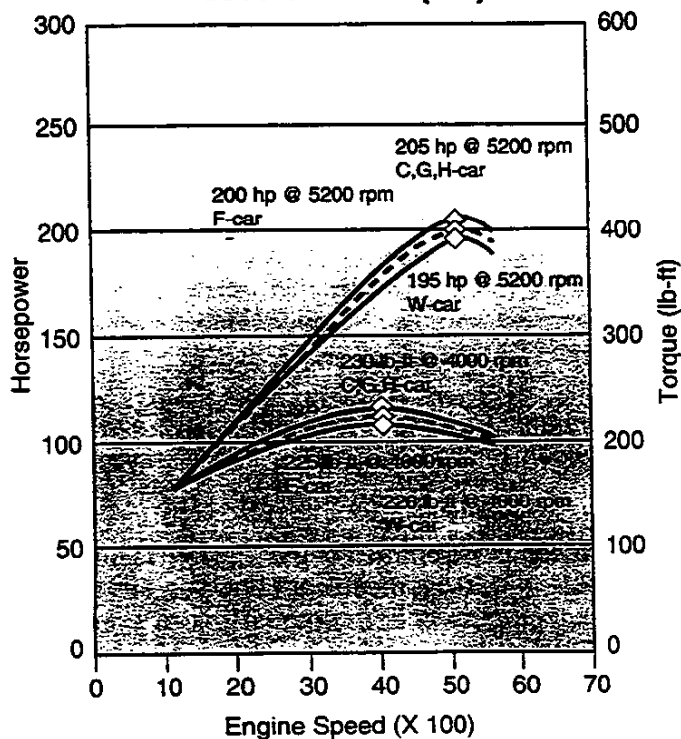

# 3.8L V6

L36

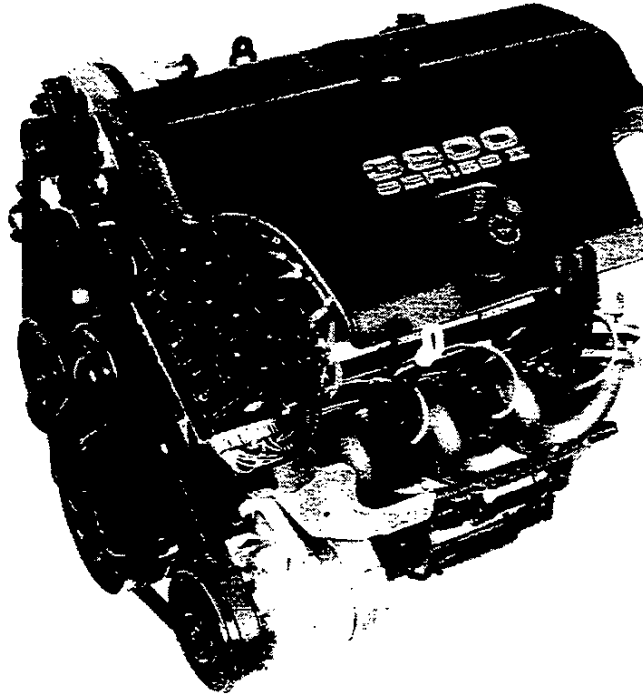

*"General Motors 90 degree 3.8L Series II 3800 V6 is one of the best engines in the world. Smooth, powerful and fuel-efficient, it's been great for years. And it keeps getting better."*

Automotive Industries

*"The power hungry will revel in the big 3800 Series II V6."*

Road & Track

*"...the 3.8 V6 provides a good balance between performance and economy. It offers gobs of torque at lower engine speeds to provide the strong performance desired during typical stop-and-go and freeway driving."*

Dan Jedlicka  
Chicago Sun-Times



WARD'S AUTO WORLD  
**Best Engines of 1996**  
TOP 10 AWARD

Automotive Engineering's  
TOP 15  
TECHNOLOGICAL INNOVATIONS



# Camaro

Dealer Order Guide inserts are your first look at Chevrolet Passenger Car models for 1997. Overall improvements, changes and deletions are highlighted. Use these inserts to assist you in ordering your initial shipments. NOTE: some information is preliminary and is subject to change.

**Positioning Statement**  
*A sophisticated sports car that you can trust to be fun, sleek and can realistically own.*

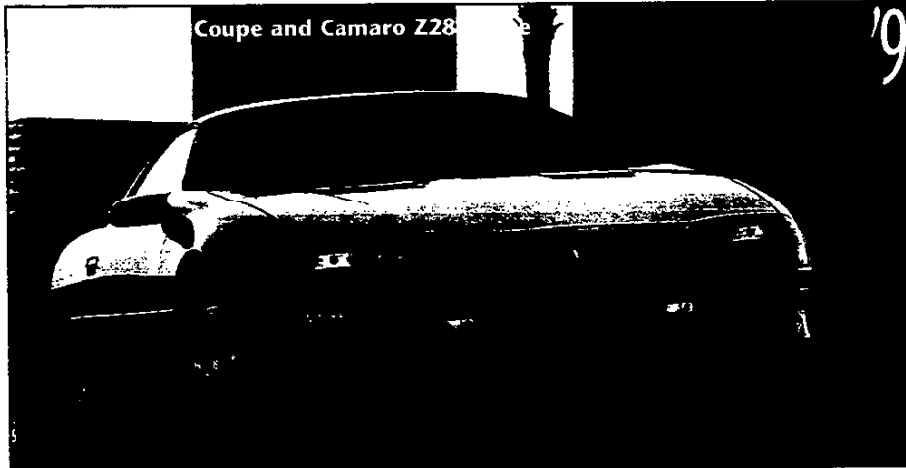

Coupe and Camaro Z28

'97

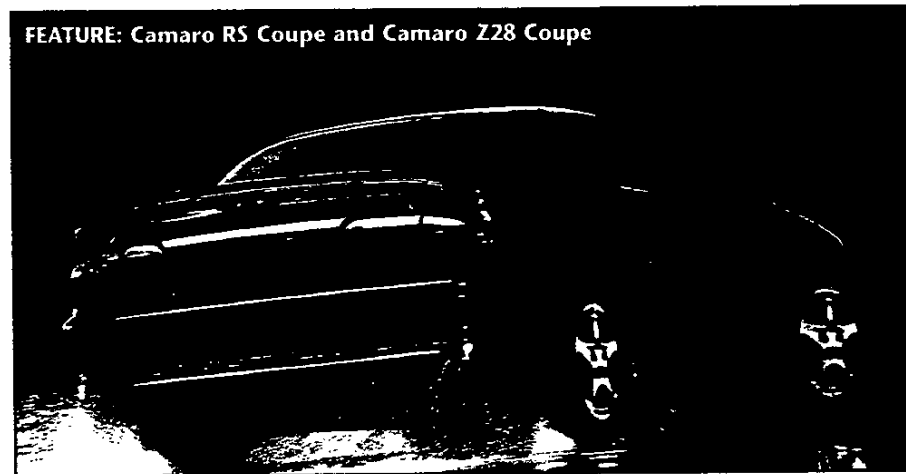

FEATURE: Camaro RS Coupe and Camaro Z28 Coupe

## FOCUS

The Focus vehicle is the model that is chosen for its saleability. It is equipped with the product features that customers want most. Generally, it is the "volume" vehicle that comprises the majority of the build. NOTE: PEG and optional equipment may vary in your locality.

### Camaro Coupe and Camaro Z28 Coupe

(image above, top)

**Ordering Recommendations:**  
Price sensitivity will most likely be an issue for 1997. Therefore, recommended Camaro Coupe content is listed below to assist your dealership in ordering.

Camaro Coupe with Preferred Equipment Group 1 (1S).

**Additional Options:**

- 4-Speed Electronically Controlled Automatic Transmission
- Electric Rear-Window Defogger
- Body-Side Moldings, Color-Keyed
- 16" Aluminum Wheels
- P235/55R-16 Blackwall Tires.

Camaro Z28 Coupe tends to be less price-sensitive. Recommended Z28 content is Preferred Equipment Group 2 (1S).

**Additional Options:**

- Same as Camaro Coupe, except for wheels.

Popular colors: Bright Red, Black, Arctic White and Bright Green Metallic.

NOTE: Use the Retail Sales Analysis (RSA) to verify or select your dealership's Camaro Focus vehicle content.

## FEATURE

The Feature vehicle is the "image" model Chevrolet will profile most in its advertising. Generally, it does the best job of capturing attention and creating consumer awareness.

### Camaro RS Coupe and Camaro Z28 Coupe

(image above, bottom)

The Feature vehicles for 1997 are Camaro RS Coupe and Camaro Z28 Coupe. Both of these fun-to-drive sports cars offer a unique level of styling. Camaro is loaded with advanced technology features that one would expect in more expensive sports cars.

Standard Camaro RS Coupe and Camaro Z28 features include:

- Driver and Front-Passenger Air Bags
- Four-Wheel Anti-Lock Brake System
- Analog Gauge Package with Tachometer standard
- P235/55R-16 Blackwall Tires
- 16" aluminum wheels
- Tilt-Wheel™ Adjustable Steering Column
- AM/FM Stereo with Cassette Player.

Camaro RS Coupe Lead Colors: Bright Purple Metallic or Bright Green Metallic.

Camaro Z28 Coupe: Bright Red.

Camaro

Photo: © 1997 GM Corp. All rights reserved.

**Trim Colors**

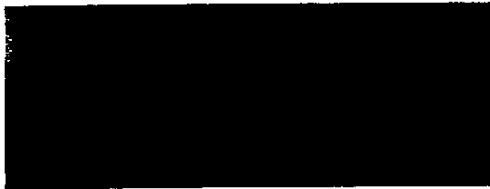

Cloth available in Neutral, Dark Gray, Medium Gray and Flame Red.\*



Leather seating surfaces available in Neutral and Dark Gray.

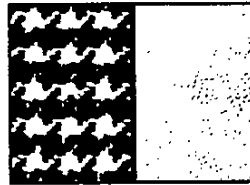

30th Anniversary Package. Cloth (left) available in Arctic White with hounds-tooth cloth inserts. Arctic White leather seating surfaces (right) available.

\*Flame Red on door trim and seat inserts only with Graphite accents.

**Seat Styles**

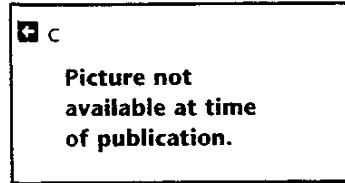
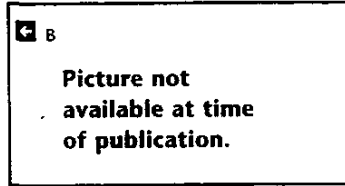
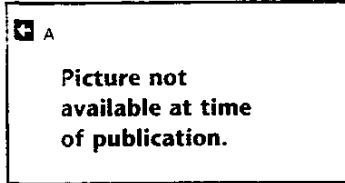

- A. Reclining cloth bucket seats. "30th Anniversary" heat-stamped on headrests.
- B. Reclining bucket seats with optional leather seating surfaces. "30th Anniversary" heat-stamped on headrests.
- C. 30th Anniversary package reclining bucket seats with "30th Anniversary" embroidered on headrests.

**Wheels**



Camaro standard 16" steel bolt-on wheel cover.



Camaro RS and Z28 standard 16" cast-aluminum wheel. Optional on Base. Chrome finish optional on Camaro RS and Z28.

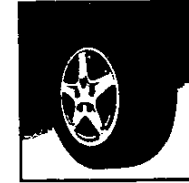

30th Anniversary Package Camaro Z28 standard white 16" Aluminum Wheel. Chrome finish optional.

**Most Popular Exterior Colors with Corresponding Interior Color Availability**

**INTERIOR MATERIAL COLORS**

	Neutral	Dark Gray	Medium Gray	Flame Red
<b>EXTERIOR COLORS</b>				
Bright Red	✓	✓	✓	✓
Black	✓	✓	✓	✓
Arctic White	✓	✓	✓	✓
Bright Green Metallic	✓	✓	✓	

See Order Guide for color availability by model.

**Most Popular Exterior Colors by Percentage**

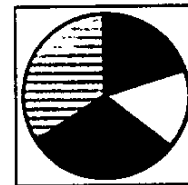

Clockwise at left are the anticipated four most popular Camaro colors for 1997, based on national sales volume. They are listed for reference only. To identify

the top-selling colors in your area, by model, use the Retail Sales Analysis (RSA).

Bright Red	20%
Arctic White	16%
Black	16%
Bright Green Metallic	14%
Other colors	34%



# Camaro

'97

**S.P.A.C.E.** (New-for-'97 features appear in color.)

*S.P.A.C.E. is an acronym to help organize and explain key features and benefits in five major categories a customer needs and wants. Overall improvements, changes and deletions are highlighted. Please review the supplied information, keeping in mind that this material is provided to you before production startup — and is liable to change.*



## SAFETY

• **AUTOMATIC DAYTIME RUNNING LAMPS** — front parking lamps automatically come on when ignition is turned on, increasing vehicle's visibility to other drivers. Also includes automatic exterior lamp control, which turns on headlamps and all other exterior lamps at full intensity when it's dark outside. System is overridden when driver utilizes headlamps manually. • **DRIVER AND FRONT-PASSENGER AIR BAGS** — help reduce the chance of injury in certain moderate to severe frontal collisions. Always wear safety belts, even with air bags. • **FOUR-WHEEL ANTI-LOCK BRAKE SYSTEM (ABS)** — helps reduce wheel lockup and helps driver maintain steering control during severe braking, even on slippery surfaces. • **PASS-KEY II THEFT-DETERRENT SYSTEM** — consists of a coded ignition key which must match a measurement circuit in the steering column to enable the engine to start.



## PERFORMANCE

• **3800 V6 WITH SFI** — a quiet, responsive engine offers 200 hp and 225 lb.-ft. of torque for outstanding performance. • **5.7 LITER LT1 V8 WITH SEQUENTIAL FUEL INJECTION** — standard in Camaro Z28, delivers 285 hp and 325 lb.-ft. of torque. • **OPTIONAL ACCELERATION SLIP REGULATION (ASR)** — a sophisticated traction control system that helps minimize wheel spin on low-traction surfaces (Z28 only). • **2ND GEAR SELECT SWITCH (V6 WITH AUTOMATIC TRANSMISSION ONLY)** — permits 2nd gear starts for improved launches on slippery surfaces. • **OPTIONAL PERFORMANCE HANDLING PACKAGE (V6 ONLY)** — includes 4-wheel disc brakes, dual outlet exhaust, 3.42:1 performance axle ratio (with automatic transmission) and sport steering ratio for extra performance.



## APPEARANCE

• **WORLDWIDE TRI-COLOR TAILLAMPS** — for enhanced appearance. • **OPTIONAL 30TH ANNIVERSARY PACKAGE (Z28 ONLY)** — includes Arctic White monochromatic exterior with white emblems, white door handles, center hugger orange stripes, white five-spoke aluminum wheels and white top on Convertible (Z28 only). • **NEW INTERIOR** — includes instrument panel, console, seat contours and fabrics. • **TWO NEW EXTERIOR COLORS** — Bright Green Metallic and Bright Purple Metallic. • **OPTIONAL 16" ALUMINUM WHEELS (STANDARD ON RS AND Z28 MODELS, OPTIONAL ON BASE MODELS)** — for enhanced exterior. • **GLASS SURFACE FOR OPTIONAL T-TOPS** — provides a rich, dark exterior surface while offering increased visibility from inside the vehicle. • **OPTIONAL MONOCHROMATIC SPECIAL ROOF TREATMENT** — T-Top Coupe and Z28 Coupe buyers have the choice of a body-color roof and mirrors.



## COMFORT AND CONVENIENCE

• **NEW FAMILY OF CHEVROLET RADIOS** — for outstanding interior sound. New Audyssey system available on some models, new 12 CD system available on all models. • **SIDE-WINDOW DEFOGGERS** — conveniently remove condensation from driver and front-passenger side windows. • **FULL-FOLDING REAR SEATBACK** — provides additional cargo-carrying flexibility. • **OPTIONAL LEATHER SEATING SURFACES** — provide quality look and feel of leather.



## EASY-TO-OWN

• **SCOTCHGARD™ FABRIC PROTECTOR** — on cloth seats, door panels, floor carpeting and floor mats; resists stains and makes cleanup easy. • **EXTENDED-LIFE COOLANT** — not scheduled to be replaced for 100,000 miles or 5 years.\* • **PLATINUM-TIP SPARK PLUGS (BOTH ENGINES)** — designed to last up to 100,000 miles.\* • **LOW OIL LEVEL INDICATOR** — warns driver of low oil level, to help prevent engine damage. • **GENUINE CUSTOMER CARE** — a 3-year/36,000-mile, no deductible, limited warranty, 24-hour roadside assistance via toll-free hot line, and courtesy transportation, if your vehicle ever needs warranty work (at participating dealers). • **BATTERY RUNDOWN PROTECTION** — automatically turns off interior lights if they are inadvertently left on.

\*Maintenance needs vary with different uses and driving conditions.

Camaro

©1996 All rights reserved.

## Competitive Models

The Camaro Coupe's primary competition includes:

- Ford Mustang
- Ford Probe
- Eagle Talon/Mitsubishi Eclipse
- Toyota Celica ST and GT
- Honda Prelude.

The main competition for Camaro Z28 includes:

- Ford Mustang GT
- Eclipse/Talon (performance versions)
- Mitsubishi 3000
- Toyota Celica GT and GTS Toyota Supra
- Nissan 300ZX (Base).

Camaro

## Additional Information on Significant Features

- The Short/Long Arm (SLA) front-suspension system on Camaro is designed for precise response to driver input, and resists wheel deflection, the tendency of the bottom of the outside wheels to angle inward in a turn. It maximizes wheel-to-road contact for excellent handling.
- The optional 30th Anniversary package for Z28 includes an Arctic White exterior with white emblems, white door handles, center hugger orange stripes and orange hood extractors, white top for Convertible, white five-spoke aluminum wheels (chrome aluminum optional), 30th Anniversary embroidery on front floor mats and headrests, Arctic White seats with black and white hounds-tooth inserts (Arctic White leather optional). Requires PEG II, P245/50ZR-16 tires and a power driver seat.
- Camaro Convertible features a power convertible top that is fully lined on the inside, and includes a glass rear window with a standard rear-window defogger. A hard, three-piece tonneau cover rounds out this attractive package.
- Camaro offers lockable T-Tops, not offered by any of the primary competition (Ford Mustang doesn't even have a sunroof). Consider marketing T-Tops as a low-cost alternative to the competitors' convertibles.

## Feature Availability

	Coupe/ RS Coupe	Convertible/ RS Convertible	Z28 Coupe	Z28 Convertible
<b>INTERIOR</b>				
Air Bags - Driver and Front-Passenger	S	S	S	S
Air Conditioning - with CFC-Free Refrigerant	O/S	S	S	S
Door Locks - Power	O	O	O	O
Defogger - Rear-Window	O	S	O	S
Gauge Package with Tachometer	S	S	S	S
Mirror - Day/Night w/Dual Reading Lamps	S	S	S	S
Scotchgard™ Fabric Protector <sup>1</sup>	S	S	S	S
Seats - Leather Surface	O	O	O	O
Steering Column - Tilt-Wheel™ Adjustable	S	S	S	S
Stereo - AM/FM w/Cassette Player	S	S	S	S
- Delco/Audyssey 200 Watt Music System AM/FM w/Cassette Player	O	O <sup>2</sup>	O	O
- Delco/Audyssey 200 Watt Music System AM/FM w/CD Player	O	O <sup>2</sup>	O	O <sup>2</sup>
- Remote 12-Disc CD Changer	O	O	O	O
Theft Deterrence - PASS-Key II	S	S	S	S
- Alarm System	O	O	O	O
Windows - Power with Driver's Express-Down Feature	O	O	O	O
<b>EXTERIOR</b>				
Exhaust System - Stainless-Steel	S	S	S	S
Daytime Running Lamps -Automatic, with Automatic Exterior Lamp Control	S	S	S	S
Mirrors - Outside, Special Black, LH Remote/RH Manual	S	NA	S	NA
- Outside, Body-Color, LH Remote/RH Manual	O <sup>3</sup>	S	O <sup>3</sup>	S
- Outside, Twin Sport Remote Electronic	O	O	O	O
Tires - P215/60R-16 Blackwall	S/NA	S/NA	NA	NA
- P235/55R-16 Blackwall	O <sup>4</sup> /S	O <sup>4</sup> /S	S	S
- P245/50ZR-16 Blackwall	NA	NA	O	O
- P245/50ZR-16 Blackwall All-Season Performance	NA	NA	O	O
Wheels - 16" Steel w/Bolt-On Wheel Covers	S/NA	S/NA	NA	NA
- 16" Aluminum	O <sup>5</sup> /S	O <sup>5</sup> /S	S	S
- 16" Chrome Aluminum	NA/O	NA/O	O	O
<b>FUNCTIONAL</b>				
Acceleration Slip Regulation	NA	NA	O	O
Brakes - Power Front Disc/Rear Drum	S	S	NA	NA
- Power Front and Rear Disc	O <sup>6</sup>	O <sup>6</sup>	S	S
- 4-Wheel Anti-Lock	S	S	S	S
Brake/Transmission Interlock <sup>7</sup>	O	O	O	O
Engine - 3800 V6 with SFI	S	S	NA	NA
- 5.7 Liter V8 with SFI	NA	NA	S	S
Limited Slip Rear Axle	O <sup>6</sup>	O <sup>6</sup>	S	S
Performance Handling Package	O	O	NA	NA
Steering - Power Rack-and-Pinion	S	S	S	S
Suspension - Firm Ride/Handling	S	S	NA	NA
- Performance Ride and Handling	NA	NA	S	S
Transmission - 5-Speed Manual	S	S	NA	NA
- 6-Speed Manual	NA	NA	S	S
- 4-Speed Electronically Controlled Automatic	O <sup>8</sup>	O <sup>8</sup>	O	O

S—Standard. O—Optional (some options may be available only as part of a Preferred Equipment Group. See your Order Guide for feature availability.) NA—Not available. 1—NA on leather seating surfaces with leather bucket seats. 2—Delco/Coaxial system on Convertible models. Delco/Audyssey system not available. 3—Available with monochromatic treatment, which includes body-color mirrors and roof. 4—Requires (N96) 16" aluminum wheels. 5—Requires (QCB) P235/55R-16 B/W tires. 6—Requires Performance Handling Package on V6 models. 7—Requires automatic transmission. 8—Includes 2nd-gear start switch.

Camaro, Camaro RS, Camaro Z28, the Camaro Emblem, Chevrolet, the Chevrolet Emblem and Solar-Ray are registered trademarks of the General Motors Corporation. PASS-Key II is a registered trademark of Delco Electronics Corp. Scotchgard is a trademark of the 3M Corp. © 1996 General Motors Corporation. All rights reserved. 7DG.3F All information correct at time of printing - 3/96.

## 1997 NEW PRODUCT HIGHLIGHTS

### CAMARO

NEW INTERIOR DESIGN FOR 1997 FEATURING REVISED INSTRUMENT PANEL, FLOOR CONSOLE AND SEAT CONTOUR.

NEW 30TH ANNIVERSARY SPECIAL EDITION Z28 (OPTION Z4C). FEATURES A WHITE EXTERIOR WITH HUGGER ORANGE HOOD, ROOF AND HATCH STRIPES. EMBROIDERED 30TH ANNIVERSARY EMBLEMS ON FLOOR MATS AND HEADRESTS, WITH EITHER BLACK AND WHITE HOUNDSTOOTH OR WHITE LEATHER INTERIOR.

30TH ANNIVERSARY HEADREST EMBLEM ON ALL CAMARO SEATS

TWO NEW COLORS ARE AVAILABLE IN 1997: BRIGHT GREEN; AND BRIGHT PURPLE. THESE TWO NEW COLORS REPLACE DARK PURPLE AND BRIGHT TEAL FROM THE 1996 PALETTE.

A NEW DARK GRAY INTERIOR COLOR REPLACES THE GRAPHITE INTERIOR.

THE MEDIUM GRAY INTERIOR COLOR IS REVISED FOR 1997.





# MANUFACTURERS MOTOR VEHICLE SPECIFICATIONS

METRIC (U.S. CUSTOMARY)

# 1997

<b>Manufacturer</b> CHEVROLET MOTOR DIVISION GENERAL MOTORS CORPORATION	<b>Vehicle Line</b>  CAMARO	
<b>Mailing Address</b>  30007 VAN DYKE WARREN, MI 48090-9065	<b>Issued</b>  September, 1996	<b>Revised</b>  

**Direct questions concerning these specifications to the manufacturer listed at**

**The information contained herein is prepared, distributed by, and is solely the responsibility of the vehicle manufacturing company to whose products it relates. This specification form was developed by the vehicle manufacturing company under the auspices of the American Automobile Manufacturers Association.**

**The General Specifications herein are those in effect at date of compilation and subject to change without notice or incurring obligation by the manufacturer.**

## AAMA

American Automobile Manufacturers Association

Blank Forms Provided by Technical Affairs Division

# Specifications

## METRIC

### Table of Contents

---

1	Vehicle Models/Origin	ø	Indicates Format Change
2	Power Teams		From Previous Year
3	Engine		
4	Lubrication System		
4	Diesel System		
5	Cooling System		
6	Fuel System		
7	Vehicle Emission Control		
7	Exhaust System		
8-10	Transmission, Axles and Shafts		
11	Suspension		
12-13	Brakes, Tires and Wheels		
14	Steering		
15-16	Electrical		
17	Body – Miscellaneous Information		
17	Frame		
18	Glass		
18	Headlamps		
19	Climate Control System		
20-21	Convenience Equipment		
21	Trailer Towing		
22-24	Vehicle Dimensions		
25	Vehicle Fiducial Marks		
26	Vehicle Mass		
27	Optional Equipment Differential Mass (Weight)		
28-34	Vehicle Dimensions Definitions – Key Sheets		
35	Index		

---

#### NOTE:

1. This form uses both SI Metric units and U.S. Customary units. The metric unit of measure is presented first, and the U.S. Customary unit follows in parentheses.
2. UNLESS OTHERWISE INDICATED:
  - a. Specifications apply to standard models without optional equipment. Significant deviations are noted.
  - b. Nominal design dimensions are used throughout these specifications.
  - c. All linear dimensions are in millimeters (inches), and all mass (weight) specifications are in kilograms (pounds).
3. The General Specifications herein are those in effect at date of compilation and are subject to change without notice or incurring obligation by the manufacturer.
4. Additional Vehicle Dimensions (based in part on SAE J1100 "Motor Vehicle Dimensions") may be available from the manufacturer.

# MVMA Specifications

Vehicle Line CAMARO  
 Model Year 1997 Issued \_\_\_\_\_ Revised (●) \_\_\_\_\_

**METRIC (U.S. Customary)**

## Vehicle Origin

Design & development (company)	General Motors, Midsize Car Division
Where built (country)	Canada
Authorized U.S. sales marketing representative	Chevrolet Motor Division

## Vehicle Models

Model Description & Drive (FWD / RWD / AWD / 4WD)*	Introduction Date	Make, Vehicle Models, Series, Body Type (Mfr's Model Code)	No. of Designated Seating Positions (Front / Rear)	Max. Trunk/Cargo Load-Kilograms (Pounds)
<b>CAMARO</b>				
2-Door Coupe (RWD)		1FP87	4 (2/2)	45.4 (100)
2-Door Convertible (RWD)		1FP67	4 (2/2)	
<b>CAMARO Z28</b>				
2-Door Coupe (RWD)		1FP87 (W/Z28)	4 (2/2)	45.4 (100)
2-Door Convertible (RWD)		1FP67 (W/Z28)	4 (2/2)	

\* FWD - Front Wheel Drive RWD - Rear Wheel Drive AWD - All Wheel Drive 4WD - Four Wheel Drive

# MVMA Specifications

Vehicle Line CAMARO  
 Model Year 1997 Issued \_\_\_\_\_ Revised (●) \_\_\_\_\_

## METRIC (U.S. Customary)

### Power Teams

SAE J1349 Net bhp (brake horsepower) and Net Torque corrected to 77°F/25°C and 29.61 in. Hg/100 kPa atmospheric pressure.

		A	B	C	D	
<b>E N G I N E</b>	Engine Code	L36	L36	LT1	LT1	
	Displacement Liters (in <sup>3</sup> )	3.8 (231)	3.8 (231)	5.7 (350)	5.7 (350)	
	Induction system (FI, Carb, etc.)	Sequential Fuel Injection	Sequential Fuel Injection	Sequential Fuel Injection	Sequential Fuel Injection	
	Compression ratio	9.4:1	9.4:1	10.4:1	10.4:1	
	SAE Net at RPM	Power kW (bhp)	149 (200) @ 5200	149 (200) @ 5200	212 (285) @ 5000	212 (285) @ 5000
		Torque N • m (lb. ft.)	305 (225) @ 4000	305 (225) @ 4000	454 (335) @ 2400	454 (335) @ 2400
	Exhaust single, dual	Single	Dual	Dual	Dual	
<b>T R A N S</b>	Transmission/ Transaxle	M49 Manual Transmission, Five-Speed	M30 Automatic Transmission, Four-Speed	M30 Automatic Transmission, Five Speed	MM6 Manual Transmission, Six-Speed	
	Effective Final Drive / Axle Ratio (std. first)	3.23	3.08 / 3.42	2.73 / 3.23	3.42	

### Series Availability

### Power Teams (A - B - C- D)

Model	Code	Standard	Optional
<b>CAMARO</b>			
2-Dr. Coupe	1FP87	A	B
2-Dr. Convertible	1FP67	A	B
<b>CAMARO Z28</b>			
2-Dr. Coupe	1FP87 (W/Z28)	C	D
2-Dr. Convertible	1FP87 (W/Z28)	C	D

# MVMA Specifications

Vehicle Line CAMARO  
 Model Year 1996 Issued \_\_\_\_\_ Revised (●) \_\_\_\_\_

## METRIC (U.S. Customary)

Engine Description	3.8 LITER V6 (231 CID) SEQUENTIAL FUEL INJECTION RPO L36
Engine Code	

### Engine - General

Type & description (inline, V, angle, flat, location, front, mid, rear, transverse, longitudinal, sohc, dohc, ohv, hemi, wedge, pre-chamber, etc.)	90 Degree V, Front, Longitudinal, OHV	
Manufacturer	General Motors Powertrain Group	
No. of cylinders	Six	
Bore	96.5 mm	
Stroke	86.36 mm	
Bore Spacing (C / L to C / L)	107.7 mm	
Cylinder block material & mass kg. (lbs.) (machined)	Cast Iron 54.8 (120.8)	
Cylinder block deck height	216.5 mm	
Cylinder block length	396 mm	
Deck clearance (minimum) (above or below block)	0.57 mm Above	
Cylinder head material & mass kg. (lbs.)	Cast Iron 13.3 (29.3)	
Cylinder head volume cm <sup>3</sup> (inches <sup>3</sup> )	62.9 (3.81)	
Cylinder liner material	Not Available	
Head gasket thickness (compressed)	1.5 mm	
Minimum combustion chamber total volume cm <sup>3</sup> (inches <sup>3</sup> )	75.675 (4.618)	
Cyl. no. system (front to rear)*	L. Bank	1-3-5
	R. Bank	2-4-6
Firing order	1-6-5-4-3-2	
Intake manifold material & mass kg. (lbs.)**	Cast Aluminum 7 (15.4) (upper and lower)	
Exhaust manifold material & mass kg. (lbs.)**	Cast Iron 3.9 (8.6)	
Knock sensor (number & location)	Two Sides of Block	
Fuel required unleaded, diesel, etc.	Unleaded	
Fuel antiknock index (R + M) + 2	87	
Engine Mounts	Quantity	Two
	Material and type (elastomeric, hydroelastic, hydraulic damper, etc.)	Elastomeric
	Added isolation (sub-frame, crossmember, etc.)	Not Applicable
Total dressed engine mass (wt) dry***	202 kg. Automatic with oil 206 kg. Manual with oil	

### Engine - Pistons

Material & mass, g (weight, oz.) - piston only	Aluminum Alloy, 0.387 kg. (0.8516)
--	------------------------------------

### Engine - Camshaft

Location	In Block above Crankshaft	
Material & mass kg (weight, lbs.)	Steel .25 (5.5)	
Drive type	Chain / belt	Chain
	Width / pitch	0.398 Over Guides /0.323

\* Rear of engine - drive takeoff. View from drive takeoff end to determine left & right side of engine.

\*\* Finished state.

\*\*\* Dressed engine mass (weight) includes the following: All those items necessary to make the engine a complete ready-to-run unit.

# MVMA Specifications

Vehicle Line CAMARO  
 Model Year 1997 Issued \_\_\_\_\_ Revised (●) \_\_\_\_\_

## METRIC (U.S. Customary)

Engine Description  
 Engine Code

5.7 LITER V8 (350 CID)  
 SEQUENTIAL FUEL INJECTION RPO LT1

### Engine - General

Type & description (inline, V, angle, flat, location, front, mid, rear, transverse, longitudinal, sohc, dohc, ohv, hemi, wedge, pre-chamber, etc.)	90 Degree V, Front, Longitudinal, OHV	
Manufacturer	General Motors Powertrain Group	
No. of cylinders	Eight	
Bore	101.6 mm	
Stroke	88.4 mm	
Bore Spacing (C/L to C/L)	111.8 mm	
Cylinder block material & mass kg. (lbs.) (machined)	Cast Iron 72.6 (160)	
Cylinder block deck height	229.4 mm	
Cylinder block length	506.2 mm	
Deck clearance (minimum) (above or below block)	.014 mm Below	
Cylinder head material & mass kg. (lbs.)	Aluminum 8.2 (18)	
Cylinder head volume cm <sup>3</sup> (inches <sup>3</sup> )	53.7 (3.28)	
Cylinder liner material	Not Applicable	
Head gasket thickness (compressed)	1.245 mm (0.049 in.)	
Minimum combustion chamber total volume cm <sup>3</sup> (inches <sup>3</sup> )	75.175 Combustion Chamber with Piston at Top Dead Center and All Components in Place Torqued to Specifications.	
Cyl. no. system (front to rear)*	L. Bank	1-3-5-7
	R. Bank	2-4-6-8
Firing order	1-8-4-3-6-5-7-2	
Intake manifold material & mass kg. (lbs.)**	Cast Aluminum 8 (17.6)	
Exhaust manifold material & mass kg. (lbs.)**	Cast Iron 6.3 (13.9)	
Knock sensor (number & location)	One - Left Side of Cylinder	
Fuel required unleaded, diesel, etc.	Unleaded	
Fuel antiknock index (R + M) + 2	87	
Engine Mounts	Quantity	Two
	Material and type (elastomeric, hydroelastic, hydraulic damper, etc.)	Elastomeric
	Added isolation (sub-frame, crossmember, etc.)	Not Applicable
Total dressed engine mass (wt) dry***	Auto 254.5 (561.1); Manual, 273.5 (603.0)	

### Engine - Pistons

Material & mass, g (weight, oz.) - piston only	Cast Aluminum (Impacted) Coated 0.532 kg. (1.17)
--	--

### Engine - Camshaft

Location	In Cylinder Block "V" Above Crankshaft	
Material & mass kg (weight, lbs.)	Steel 4.06 (Nine)	
Drive type	Chain / belt	Chain
	Width / pitch	

- \* Rear of engine - drive takeoff. View from drive takeoff end to determine left & right side of engine.
- \*\* Finished state.
- \*\*\* Dressed engine mass (weight) includes the following: All those items necessary to make the engine a complete ready-to-run unit.

# MVMA Specifications

Vehicle Line CAMARO  
 Model Year 1997 Issued \_\_\_\_\_ Revised (●) \_\_\_\_\_

## METRIC (U.S. Customary)

Engine Description  
 Engine Code

3.8 LITER V6 (231 CID)  
 SEQUENTIAL FUEL INJECTION RPO L36

### Engine - Valve System

Hydraulic lifters (std., opt., n.a.)		Standard
Valves	Number intake / exhaust	Six/Six
	Head O.D. intake / exhaust	45.72 mm/ 38.6 mm

### Engine - Connecting Rods

Material & mass kg., (weight, lbs.)*	Pearlitic Malleable Iron 0.63 (1.4)
Length (axes C/L to C/L)	145.85 mm

### Engine - Crankshaft

Material & mass kg., (weight, lbs.)*	Nodular Cast Iron 15.4 (34)	
End thrust taken by bearing (no.)	Two	
Length & number of main bearings	21.95 mm Four	
Seal (material, one, two piece design, etc.)	Front	One Piece Rubber Lip
	Rear	One Piece Rubber Lip

### Engine - Lubrication System

Normal oil pressure kPa (psi) at engine rpm	414 (60) @ 2000 RPM
Type oil intake (floating, stationary)	Stationary
Oil filter system (full flow, part, other)	Full Flow
Capacity of c/case, less filter-refill-L (qt.)	3.78 (4.0)

### Engine - Diesel Information

(NOT APPLICABLE)

Diesel engine manufacturer		
Glow plug, current drain at 0°F.		
Injector nozzle	Type	
	Opening pressure kPa (psi)	
Pre-chamber design		
Fuel injection pump	Manufacturer	
	Type	
Fuel injection pump drive (belt, chain, gear)		
Supplementary vacuum source (type)		
Fuel heater (yes/no)		
Water separator, description (std., opt.)		
Turbo manufacturer --		
Oil cooler-type (oil to engine coolant; oil to ambient air)		
Oil filter		

### Engine - Intake System

(NOT APPLICABLE)

Turbo charger - manufacturer	
Super charger - manufacturer	
Intercooler	

\* Finished State

# MVMA Specifications

Vehicle Line CAMARO  
 Model Year 1997 Issued \_\_\_\_\_ Revised (●) \_\_\_\_\_

## METRIC (U.S. Customary)

Engine Description  
 Engine Code

5.7 LITER V8 (350 CID)  
 SEQUENTIAL FUEL INJECTION RPO LT1

### Engine - Valve System

Hydraulic lifters (std., opt., n.a.)		Standard
Valves	Number intake / exhaust	Eight/Eight
	Head O.D. intake / exhaust	49.28 mm / 38.10 mm

### Engine - Connecting Rods

Material & mass kg., (weight, lbs.)*	Powder Metal .67 (1.3)
Length (axes C/L to C/L)	144.78 mm

### Engine - Crankshaft

Material & mass kg., (weight, lbs.)*	Nodular Cast Iron, 23.8 (52.5)	
End thrust taken by bearing (no.)	Five	
Length & number of main bearings	Five	
Seal (material, one, two piece design, etc.)	Front	Fluroelastomer / One Piece, Lip Seal
	Rear	Fluroelastomer / One Piece, Lip Seal

### Engine - Lubrication System

Normal oil pressure kPa (psi) at engine rpm	41 (6) @ 1000 / 124 (18) @ 2000 / 165 (24) @ 4000 (Hot)
Type oil intake (floating, stationary)	Stationary
Oil filter system (full flow, part, other)	Full Flow
Capacity of c/case, less filter-refill-L (qt.)	3.8 (4.0), Without Filter, 4.7 (5.0), With Filter

### Engine - Diesel Information

(NOT APPLICABLE)

Diesel engine manufacturer		
Glow plug, current drain at 0°F.		
Injector nozzle	Type	
	Opening pressure kPa (psi)	
Pre-chamber design		
Fuel Injection pump	Manufacturer	
	Type	
Fuel injection pump drive (belt, chain, gear)		
Supplementary vacuum source (type)		
Fuel heater (yes/no)		
Water separator, description (std., opt.)		
Turbo manufacturer		
Oil cooler-type (oil to engine coolant; oil to ambient air)		
Oil filter		

### Engine - Intake System

(NOT APPLICABLE)

Turbo charger - manufacturer		
Super charger - manufacturer		
Intercooler		

\* Finished State



# MVMA Specifications

Vehicle Line CAMARO  
 Model Year 1997 Issued \_\_\_\_\_ Revised (●) \_\_\_\_\_

## METRIC (U.S. Customary)

Engine Description  
 Engine Code

3.8 LITER V6 (231 CID)  
 SEQUENTIAL FUEL INJECTION RPO L36

### Engine - Cooling System

Coolant recovery system (std., opt., n.a.)		Standard	
Coolant fill location (rad., bottle)		Bottle	
Radiator cap relief valve pressure kPa (psi)		124 (18)	
Circulation thermostat	Type (choke, bypass)	Bypass	
	Starts to open at °C (°F)	91 (195)	
Water pump	Type (centrifugal, other)	Centrifugal	
	GMP 1000 pump rpm	10.0	
	Number of pumps	One	
	Drive (V-belt, other)	Serpentine	
	Bearing type	Ball Roller	
	Impeller material	Stamped Steel	
Housing material		Cast Aluminum	
By-pass recirculation type (inter., ext.)		External	
Cooling System capacity	With heater - L (qt.)	12.65 (13.37) Auto; 12.85 (13.58) Manual	
	With air conditioner - L (qt.)	12.65 (13.37) Auto; 12.85 (13.58) Manual	
	Opt. equipment specify - L (qt.)	No	
Water jackets full length of cyl. (yes, no)		Yes	
Water all around cylinder (yes, no)		No	
Water jackets open at head face (yes, no)			
Radiator core	Std., A/C, HD	Standard	A/C Optional
	Type (cross-flow, etc.)	Cross Flow	
	Construction (fin & tube mechanical, braze, etc.)	Vacuum Brazed Tube & Fin	
	Material, mass kg (wgt., lbs.)	Aluminum, 3.1 (6.8)	Aluminum, 3.77 (8.3)
	Width	630 mm (24.8 in.) w/o TOC	630 mm (24.8 in.) w/TOC
	Height	438 mm (17.2 in.)	
	Thickness	23.5 mm (0.925 in.)	
	Fins per inch	16.93	
Radiator end tank material		Glass - Reinforced Nylon	
Fan	Std., elec., opt.	Standard, Electric	
	Number of blades & type (flex, solid, material)	Five Blades, Solid, Plastic	Five Blades, Solid, Plastic
	Number & location (front, rear of radiator)	Single Puller	Dual Pullers
	Diameter & projected width	415 mm Dia. / 72 mm Width	316 mm Dia. / 72 mm Width
	Ratio (fan to crankshaft rev.)	-	
	Fan cutout type	ECM Controlled	
	Drive type (direct, remote)	-	
	RPM at idle (elec.)	1800-2000	1950-2150
	Motor rating (wattage/elec.)	150 W	100 W. Each
	Motor switch (type & location/elec.)	Relay	
	Switch point (temp./pressure/elec.)	Left, 226 F / 248 psi Right, 235 F / 248 psi	
	Fan shroud (material)	Nylon Six/Six	

# MVMA Specifications

Vehicle Line CAMARO  
 Model Year 1997 Issued \_\_\_\_\_ Revised (●) \_\_\_\_\_

## METRIC (U.S. Customary)

Engine Description  
 Engine Code

5.7 LITER V8 (350 CID)  
 SEQUENTIAL FUEL INJECTION RPO LT1

### Engine - Cooling System

Coolant recovery system (std., opt., n.a.)		Standard	
Coolant fill location (rad., bottle)		Bottle	
Radiator cap relief valve pressure kPa (psi)		124 (18)	
Circulation thermostat	Type (choke, bypass)	Choke	
	Starts to open at °C (°F)	82 (180)	
Water pump	Type (centrifugal, other)	Centrifugal	
	GMP 1000 pump rpm	13	
	Number of pumps	One	
	Drive (V-belt, other)	Gear Driven	
	Bearing type	Sealed Double Row Ball	
	Impeller material	Steel	
Housing material		Cast Aluminum	
By-pass recirculation type (inter., ext.)		Internal	
Cooling System capacity	With heater - L (qt.)	14.3 (15.1), Auto.; 14.5 (15.3), Manual	
	With air conditioner - L (qt.)	14.3 (15.1), Auto.; 14.5 (15.3), Manual	
	Opt. equipment specify - L (qt.)	-	
Water jackets full length of cyl. (yes, no)		Yes	
Water all around cylinder (yes, no)		Yes	
Water jackets open at head face (yes, no)		No	
Radiator core	Std., A/C, HD	Standard	A/C (C60) - Optional
	Type (cross-flow, etc.)	Cross-Flow	
	Construction (fin & tube mechanical, braze, etc.)	C.A.B. Brazed Tube & Fin	
	Material, mass kg (wgt., lbs.)	Aluminum, 4.65 (10.3)	Aluminum, 5.3 (11.7)
	Width	630 mm (24.8 in.) W/O TOC	630 mm (24.8 in.) W/TOC
	Height	438 mm (17.2 in.)	
	Thickness	34.0 mm (1.3 in.)	
	Fins per inch	20.32	
Radiator end tank material		Glass - Reinforced Nylon	
Fan	Std., elec., opt.	Standard, Electric	A/C (C60) - Electric
	Number of blades & type (flex, solid, material)	5 Blades, Solid, Plastic	5 Bladed, Solid, Plastic
	Number & location (front, rear of radiator)	Single Puller	Dual Pullers
	Diameter & projected width	415 mm Dia. / 72 mm Width	316 mm Dia. / 72 mm Width
	Ratio (fan to crankshaft rev.)	-	-
	Fan cutout type	ECM Controlled	ECM Controlled
	Drive type (direct, remote)	-	-
	RPM at idle (elec.)	1800-2000	2100-2300
	Motor rating (wattage/elec.)	150 W	150 W, Each
	Motor switch (type & location/elec.)	Relay	Relay
	Switch point (temp./pressure/elec.)		Left, 226 F / 248 psi Right, 235 F / 248 psi
	Fan shroud (material)	Nylon Six/Six	Nylon Six/Six

# MVMA Specifications

Vehicle Line CAMARO  
 Model Year 1997 Issued Revised (●)

## METRIC (U.S. Customary)

Engine Description	3.8 LITER V6 (231 CID)
Engine Code	SEQUENTIAL FUEL INJECTION RPO L36

### Engine - Fuel System (See Supplemental page for details of Fuel Injection, Supercharger, Turbocharger, etc. if used.)

Induction type: carburetor, fuel injection system, etc.		Sequential Fuel Injection
Manufacturer		Delphi Energy & Engine Management Systems
Carburetor no. of barrels		Not Applicable
Idle A/F mix.		PCM Controlled
Fuel injection	Point of injection (no.)	Port (Six)
	Constant, pulse, flow	Pulse
	Control (electronic, mech.)	Electronic
	System pressure kPa (psi)	280 - 350 (33-43)
Idle speed-rpm (spec. neutral or drive and propane if used)	Manual	PCM Controlled
	Automatic	PCM Controlled
Intake manifold heat control (exhaust or water thermostatic or fixed)		Water Thermostatic
Air cleaner type		Paper Element
Fuel filter (type/location)		Paper Element
Fuel pump	Type (elec. or mech.)	Electric
	Location (eng., tank)	Fuel Tank
	Pressure range kPa (psi)	0-500 kPa
	Flow rate at regulated pressure l (gal)/hr @ kPa (psi)	115.4 L/hr @ 300 kPa

### Fuel Tank

Capacity refill L (gallons)		58.6 (15.5)
Location (describe)		Rear and Above Rear Axle
Attachment		Two Metal (Steel) Straps
Material & Mass kg. (weight lbs.)		Long Teme Sheet Steel GM-7M, 9.0 (19.8)
Filler pipe	Location & material	Left Rear Quarter Panel (Coated Steel Tube)
	Connection to tank	Soldered on Left Side
Fuel line (material)		Nylon and Coated Steel Tubing
Fuel hose (material)		Nylon and Coated Steel Tubing
Return line (material)		Not Available
Vapor line (material)		Not Available
Extended range tank	Opt., n.a.	Not Available
	Capacity L (gallons)	Not Available
	Location & material	Not Available
	Attachment	Not Available
Auxiliary tank	Opt., n.a.	Not Available
	Capacity L (gallons)	Not Available
	Location & material	Not Available
	Attachment	Not Available
	Selector switch or valve	Not Available
Separate fill		Not Available

# MVMA Specifications

Vehicle Line **CAMARO**  
 Model Year **1997** Issued Revised (●)

## METRIC (U.S. Customary)

Engine Description  
 Engine Code

**5.7 LITER V8 (350 CID)**  
**SEQUENTIAL FUEL INJECTION RPO LT1**

### Engine - Fuel System (See Supplemental page for details of Fuel Injection, Supercharger, Turbocharger, etc. if used.)

Induction type: carburetor, fuel injection system, etc.		Sequential Fuel Injection
Manufacturer		Delphi
Carburetor no. of barrels		Not Available
Idle A/F mix.		Preset - No Adjustment Provided
Fuel injection	Point of injection (no.)	Fuel injectors at Inlet Ports
	Constant, pulse, flow	Pulse
	Control (electronic, mech.)	Electronic - On Board Computer
	System pressure kPa (psi)	300 (43.5)
Idle speed-rpm (spec. neutral or drive and propane if used)	Manual	PCM Controlled
	Automatic	PCM Controlled
	-	
Intake manifold heat control (exhaust or water thermostatic or fixed)		Not Available
Air cleaner type		Replaceable Paper Element
Fuel filter (type/location)		Inline Replaceable Stainless Steel (W/Paper Element) Located Near Fuel Tank
Fuel pump	Type (elec. or mech.)	Electric
	Location (eng., tank)	Fuel Tank
	Pressure range kPa (psi)	Normal 83.0 (12.0), Shut Off 135 (19.6)
	Flow rate at regulated pressure L (gal)/hr @ kPa (psi)	23-30 gr/sec @ 83 (12.0)

### Fuel Tank

Capacity refill L (gallons)		58.6 (15.5)
Location (describe)		Rear and Above Rear Axle
Attachment		Two Metal (Steel) Straps
Material & Mass kg. (weight lbs.)		Long Term Sheet Steel GM-7M, 9.0 (19.8)
Filler pipe	Location & material	Left Rear Quarter Panel (Coated Steel Tube)
	Connection to tank	Soldered on Left Side
Fuel line (material)		Nylon and Coated Steel Tubing
Fuel hose (material)		Nylon
Return line (material)		Nylon and Coated Steel Tubing
Vapor line (material)		Nylon and Coated Steel Tubing
Extended range tank	Opt., n.a.	Not Available
	Capacity L (gallons)	Not Available
	Location & material	Not Available
	Attachment	Not Available
Auxiliary tank	Opt., n.a.	Not Available
	Capacity L (gallons)	Not Available
	Location & material	Not Available
	Attachment	Not Available
	Selector switch or valve	Not Available
Separate fill		Not Available

# MVMA Specifications

Vehicle Line CAMARO  
 Model Year 1997 Issued \_\_\_\_\_ Revised (●) \_\_\_\_\_

## METRIC (U.S. Customary)

Engine Description  
 Engine Code

3.8 LITER V6 (231 CID)  
 SEQUENTIAL FUEL INJECTION RPO L36

### Vehicle Emission Control

Type (air injection, engine modifications, other)		Engine Modification	
Exhaust Emission Control	Air injection	Pump or pulse	Not Applicable
		Driven by	Not Applicable
		Air distribution (head, manifold, etc.)	Not Applicable
		Point of entry	Not Applicable
	Exhaust Gas	Type (controlled flow, open orifice, other)	Controlled Flow, Linear
		Exhaust source	Exhaust Manifold
	Recirculation	Point of exhaust injection (spacer, carburetor, manifold, other)	Intake Manifold
		Catalytic Converter	Type
	Number of		Two
	Locations(s)		Underfloor
Volume L (in <sup>3</sup> )	170 in <sup>3</sup>		
Substrate type	Monolithic/Ceramic		
Noble metal type	Pt / Pd / Rh		
Crankcase Emission Control	Type (ventilates to atmosphere, induction system, other)	Positive Vent to Induction System	
	Energy source (manifold vacuum, carburetor, other)	Manifold Vacuum	
	Discharges to (intake manifold, other)	Intake Manifold	
	Air inlet (breather cap, other)	Throttle Body	
Evaporative Emission Control	Vapor vented to (crankcase, canister, other)	Fuel Tank	Canister
		Carburetor	Not Applicable
	Vapor storage provision	Charcoal	
Electronic system	Closed loop (yes/no)	Yes	
	Open loop (yes/no)	No	

### Engine - Exhaust System

Type (single, single with cross-over, dual, other)	Single - All Stainless System	
Muffler no. & type (reverse flow, straight thru, separate resonator), Muffler volume (liters), Material & Mass kg. (weight lbs.)	One Stainless Steel Muffler with One Tail Pipe 7.2 (15.9)	
Resonator no., type, & volume (liters)	Not Available	
Exhaust pipe	Branch o.d., wall thickness	
	Main o.d., wall thickness	
	Material & Mass kg. (weight lbs.)	
Intermediate pipe	o.d. & wall thickness	2.25 in. x 1.25 in. Stainless Steel
	Material & Mass kg. (weight lbs.)	Stainless Steel, 46 (10.1)
Tail pipe	o.d. & wall thickness	2.5 in. x 1.25 in. Stainless Steel
	Material & Mass kg. (weight lbs.)	Stainless Steel, 1.0 (2.2)

# MVMA Specifications

Vehicle Line CAMARO  
 Model Year 1997 Issued \_\_\_\_\_ Revised (●) \_\_\_\_\_

## METRIC (U.S. Customary)

Engine Description  
 Engine Code

5.7 LITER V8 (350 CID)  
 SEQUENTIAL FUEL INJECTION RPO LT1..

### Vehicle Emission Control

Type (air injection, engine modifications, other)		Air Injection W/Computer Command Control		
Exhaust Emission Control	Air injection	Pump or pulse	Vane	
		Driven by	Electric	
		Air distribution (head, manifold, etc.)	Exhaust Manifold (Computer Command Control)	
		Point of entry	Exhaust Manifold, Top Center Two Exhaust Ports	
	Exhaust Gas	Type (controlled flow, open orifice, other)	Controlled Flow, Linear	
		Exhaust source	Exhaust Manifold	
	Recirculation	Point of exhaust injection (spacer, carburetor, manifold, other)	Intake Manifold	
		Type	Three-Way Catalyst	
	Catalytic Converter	Number of	One	
		Locations(s)	Under Body	
Volume L (in <sup>3</sup> )		2.79 (170.1)		
Substrate type		Monolith		
Noble metal type		Platinum (Pt), Rhodium (Rh)		
Crankcase Emission Control	Noble metal concentration (g/cm <sup>3</sup> )		0.001118	
	Type (ventilates to atmosphere, induction system, other)		Induction System	
	Energy source (manifold vacuum, carburetor, other)		Manifold Vacuum	
	Discharges to (intake manifold, other)		Intake Plenum	
Evaporative Emission Control	Air inlet (breather cap, other)		Air Cleaner	
	Vapor vented to (crankcase, canister, other)	Fuel Tank	Charcoal	
		Carburetor	--	
	Vapor storage provision		Canister	
Electronic system	Closed loop (yes/no)		Yes	
	Open loop (yes/no)		No	

### Engine - Exhaust System

Type (single, single with cross-over, dual, other)		Single - All Stainless Steel System
Ø	Muffler no. & type (reverse flow, straight thru, separate resonator), Muffler volume (liters), Material & Mass kg. (weight lbs.)	One Stainless Steel Muffler with Dual Tail Pipes
Ø	Resonator no., type, & volume (liters)	Not Available
Exhaust pipe	Branch o.d., wall thickness	2.25 in. Laminated Pipes, 0.7mm Each Layer
	Main o.d., wall thickness	
	Material & Mass kg. (weight lbs.)	Stainless Steel, 4.0 (8.8)
Intermediate pipe	o.d. & wall thickness	2.75 in. x 1.25 mm, Stainless Steel
	Material & Mass kg. (weight lbs.)	Stainless Steel, 5.0 (11.0)
Tail pipe	o.d. & wall thickness	2.25 in. x 1.25 mm, Stainless Steel
	Material & Mass kg. (weight lbs.)	Stainless Steel, 1.8 (3.97)

# MVMA Specifications

Vehicle Line CAMARO  
 Model Year 1997 Issued \_\_\_\_\_ Revised (#) \_\_\_\_\_

## METRIC (U.S. Customary)

Engine Description  
 Engine Code

3.8 LITER V6 (231 CID)  
 SEQUENTIAL FUEL INJECTION RPO L36

### Transmissions/Transaxle (Std., Opt., N.A.)

Manual 4-speed (manufacturer/country)	Not Applicable
Manual 5-speed (manufacturer/country)	Borg Warner, USA (M49)
Manual 6-speed (manufacturer/country)	Not Applicable
Automatic (manufacturer/country)	Not Applicable
Automatic overdrive (manufacturer/country)	GM Powertrain Group, USA

### Manual Transmission/Transaxle

Number of forward speeds		Five
Gear ratios	1st	3.75
	2nd	2.19
	3rd	1.41
	4th	1.00
	5th	0.72
	6th	Not Applicable
	Reverse	3.53
Synchronous meshing (specify gears)		1-2-3-4-5
Shift lever location		Trans. Extension
Trans. case material & mass kg. (lbs.)*		Aluminum 43.2 (95.3)
Lubricant	Capacity L (pt.)	3.2 (6.8)
	Type recommended	Dexron III

### Clutch (Manual Transmission)

Clutch manufacturer		
Clutch type (dry, wet, single, multiple disc)		
Linkage (hydraulic, cable, rod, lever, other)		
Max. pedal effort (nom. spring load) N (lbs.)	Depressed	
	Released	
Assist (spring, power/percent, nominal)		
Type pressure plate springs		
Total spring load (nominal) N (lbs.)		
Clutch facing	Facing mfg. & material coding	
	Facing material & construction	
	Rivets per facing	
	Outside x inside dia. (nominal)	
	Total eff. area cm <sup>2</sup> (in. <sup>2</sup> )	
	Thickness (pressure plate side/wheel side)	
	Rivet depth (pressure plate side/wheel side)	
	Engagement cushion method	
Release bearing type & method lub.		
Torsional damping method, springs, hysteresis		

\* Includes shift linkage, lubricant, and clutch housing. If other specify.

# MVMA Specifications

Vehicle Line CAMARO  
 Model Year 1997 Issued \_\_\_\_\_ Revised (●) \_\_\_\_\_

## METRIC (U.S. Customary)

Engine Description  
 Engine Code

5.7 LITER V8 (350 CID)  
 SEQUENTIAL FUEL INJECTION RPO LT1 ..

### Transmissions/Transaxle (Std., Opt., N.A.)

Manual 4-speed (manufacturer/country)	Not Applicable
Manual 5-speed (manufacturer/country)	Not Applicable
Manual 6-speed (manufacturer/country)	Borg-Warner - U.S.A.
Automatic (manufacturer/country)	Not Applicable
Automatic overdrive (manufacturer/country)	GM Powertrain Group, USA

### Manual Transmission/Transaxle

Number of forward speeds		Six
Gear ratios	1st	2.66
	2nd	1.78
	3rd	1.30
	4th	1.00
	5th	0.74
	6th	0.50
	Reverse	2.90
Synchronous meshing (specify gears)		All (One -Six6 Plus Reverse)
Shift lever location		Trans. Extension
Trans. case material & mass kg. (lbs.)*		Aluminum, 59.4 (131.0)
Lubricant	Capacity L (pt.)	3.84 (8.13)
	Type recommended	Dexron III

### Clutch (Manual Transmission)

Clutch manufacturer		Valeo Clutches & Transmissions
Clutch type (dry, wet; single, multiple disc)		280 mm Pull Type - Dry Clutch
Linkage (hydraulic, cable, rod, lever, other)		Hydraulic Pre-Filled
Max. pedal effort (nom. spring load) N (lbs.)	Depressed	133 (30)
	Released	115 (26)
Assist (spring, power/percent, nominal)		None
Type pressure plate springs		Diaphragm
Total spring load (nominal) N (lbs.)		9400 (2136)
Clutch facing	Facing mfg. & material coding	Valeo F-202
	Facing material & construction	Non-Asbestos Woven
	Rivets per facing	32
	Outside x inside dia. (nominal)	280 x 180 mm (11.02 x 7.09 in.)
	Total eff. area cm <sup>2</sup> (in. <sup>2</sup> )	361.3 (56.0)
	Thickness (pressure plate side/ty wheel side)	3.3 / 3.3 mm (0.130 / 0.130 in.)
	Rivet depth (pressure plate side/ty wheel side)	1.1 mm (0.043 in.)
Engagement cushion method		Cushion Springs
Release bearing type & method lub.		Angular Contact Ball Bearing
Torsional damping method, springs, hysteresis		Disk Douted Torsional Spring Damper

\* Includes shift linkage, lubricant, and clutch housing. If other specify.



# MVMA Specifications

Vehicle Line CAMARO  
 Model Year 1997 Revised (●) \_\_\_\_\_

## METRIC (U.S. Customary)

Engine Description 3.8 LITER V6 (231 CID)  
 Engine Code SEQUENTIAL FUEL INJECTION RPO L36

### Automatic Transmission/Transaxle

Trade Name		Hydra-Matic 4L60-E Transmission		
Type and special features (describe)		Four-Speed Electronic Controlled Automatic (Overdrive 4th Gear, Lock-up Torque Converter Clutch)		
Shift mechanics		Hydraulic Clutches/Electronic Controls		
Gear selector	Location (column, floor, other)	Floor		
	Ltr./No. designation (e.g. PRND21)	P-R-N- <u>D</u> -D-2-1		
	Shift interlock (yes, no, describe)	Yes, Brake Interlock		
Gear ratios	1st	3.06		
	2nd	1.63		
	3rd	1.00		
	4th	0.70		
	5th	Not Applicable		
	6th	Not Applicable		
	Reverse	2.29		
Final drive ratio		3.08 or 3.42		
Max. upshift vehicle speed - drive range km/h (mph)	3.08	One - Two = 71	Two - Three = 126	Three - Four = 179
	3.42	One - Two = 62	Two - Three = 117	Three - Four = 179
Max. upshift engine speed RPM		6000		
Max. kickdown speed - drive range km/h (mph)	3.08	Four - Three = 175	Three - Two = 109	Two - One = 45
	3.42	Four - Three = 175	Three - Two = 101	Two - One = 45
Min. overdrive speed km/h (mph)		74		
Torque converter	Type	Three Element with Converter Clutch		
	Torus design	Full Function		
	Number of elements	Three		
	Max. ratio at stall	1.6		
	Type of cooling (air, liquid)	Liquid		
	Nominal diameter	245 mm		
Capacity factor "K"		122		
Pump type		Variable Displacement Vane		
Lubricant	Capacity refill L (pt.)	4.8 (10)		
	Type recommended	Dexron III		
Oil cooler (std., opt., N.A., internal, external, air, liquid)		Standard, Integral with Radiator, Liquid		
Transmission mass kg (lbs.) & case material**		75.9 (167) Wet, Aluminum		

### All Wheel / 4 Wheel Drive

(NOT APPLICABLE)

Description & type (part-time, full-time, 2/4 shift while moving, mechanical, elect., chain/gear, etc.)		
Transfer case	Manufacturer and model	
	Type and location	
Low-range gear ratio		
System disconnect (describe)		
Center differential	Type (bevel, planetary, w or w/o viscous bias, torsen, etc.)	
	Torque split (% front/rear)	

\* Input speed +  $\sqrt{\text{torque}}$

\*\* Dry weight including torque converter. If other, specify.

# MVMA Specifications

Vehicle Line CAMARO  
 Model Year 1997 Issued \_\_\_\_\_ Revised (●) \_\_\_\_\_

## METRIC (U.S. Customary)

Engine Description  
 Engine Code

5.7 LITER V8 (350 CID)  
 SEQUENTIAL FUEL INJECTION RPO LT1

## Automatic Transmission/Transaxle

Trade Name		Hydra-Matic 4L60-E Transmission			
Type and special features (describe)		Four-Speed Electronic Controlled Automatic (Overdrive Transmission with Lock-Up Torque Converter Clutch)			
Shift mechanics		Hydraulic Clutches/Electronic Controls			
Gear selector	Location (column, floor, other)	On Floor Console			
	Ltr./No. designation (e.g. PRND21)	P-R-N- <b>D</b> -D-2-1			
	Shift interlock (yes, no, describe)	Yes (Brake Interlock)			
Gear ratios	1st	3.06			
	2nd	1.63			
	3rd	1.0			
	4th	0.70			
	5th	Not Applicable			
	6th	Not Applicable			
	Reverse	2.29			
Final drive ratio		2.73 or 3.23			
Max. upshift vehicle speed - drive range km/h (mph)		One - Two = 77 One - Two = 58	Two - Three = 150 Two - Three = 117	Three - Four = 241 Three - Four = 203	2.73 Axle 3.23 Axle
Max. upshift engine speed RPM		5200			
Max. kickdown speed - drive range km/h (mph)		Four - Three = 229 Four - Three = 190	Three - Two = 138 Three - Two = 108	Two - One = 47 Two - One = 50	2.73 Axle 3.23 Axle
Min. overdrive speed km/h (mph)		43 (27), 2.73 Axle; 51 (32), 3.23 Axle			
Torque converter	Type	Three Element with Converter Clutch			
	Torus design	Full Function			
	Number of elements	Three			
	Max. ratio at stall	1.91			
	Type of cooling (air, liquid)	Liquid			
	Nominal diameter	298 mm			
Capacity factor "K"	100				
Pump type		Variable Displacement Vane			
Lubricant	Capacity refill L (pt.)	4.8 (10)			
	Type recommended	Dexron III			
Oil cooler (std., opt., N.A., internal, external, air, liquid)		Standard, Integral with Radiator, Liquid			
Transmission mass kg (lbs.) & case material**		83 (184) Wet, Aluminum			

## All Wheel / 4 Wheel Drive

(NOT APPLICABLE)

Description & type (part-time, full-time, 2/4 shift while moving, mechanical, elect., chain/gear, etc.)		
Transfer case	Manufacturer and model	
	Type and location	
Low-range gear ratio		
System disconnect (describe)		
Center differential	Type (bevel, planetary, w or w/o viscous bias, torsen, etc.)	
	Torque split (% front/rear)	

\* Input speed +  $\sqrt{\text{torque}}$

\*\* Dry weight including torque converter. If other, specify.

# MVMA Specifications

Vehicle Line CAMARO  
 Model Year 1997 Issued \_\_\_\_\_ Revised (●) \_\_\_\_\_

## METRIC (U.S. Customary)

Engine Description  
 Engine Code

3.8 LITER V6 (231 CID)  
 SEQUENTIAL FUEL INJECTION RPO L36.

### Axle Ratio and Tooth Combinations (See 'Power Teams' for axle ratio usage)

AUTOMATIC - M30

Axle ratio (or overall top gear ratio)		3.42 (2.39)
Ring gear o.d.		7.625
No. of teeth	Pinion	12
	Ring gear	41

### Rear Axle Unit

Description		Salisbury/Beam HSG
Limited slip differential (type)		Not Applicable
Drive pinion	Type	Hypoid
	Offset	1.50"
No. of differential pinions		Two
Pinion / differential	Adjustment (shim, etc.)	Shim
	Bearing adjustment	Shim
Driving wheel bearing (type)		Cylindrical Roller Direct on Shafts, Drawn Cup
Lubricant	Capacity L (pt.)	1.65 (3.5)
	Type recommended	GM Lube # 9985182

### Propeller Shaft - Rear Wheel Drive

Manufacturer Type (straight tube, tube-in-tube, internal-external damper, etc.)		American Axle and Manufacturing Two Piece with Internal Damper	
Outer diam. x length* x wall thickness	Manual 4-speed transmission	Not Applicable	
	Manual 5-speed transmission	Not Applicable	
	Manual 6-speed transmission	Not Applicable	
	Overdrive		
Intermediate bearing	Automatic transmission	69.9 x 1057.0 x 1.65 mm (2.75 x 41.6 x 0.065 in.) *	
	Type (plain, anti-friction)	Anti-Friction	
Sip yoke	Lubrication (fitting, prepack)	Prepack	
	Type	Splined	
	Number of teeth	27	
Universal joints	Spline o.d.	29.87 mm (1.176 in.)	
	Make and mfg. no.	Front	American Axle & Manufacturing, S-44
		Rear	American Axle & Manufacturing, S-44
	Number used	Two	
	Type (ball and trunnion, cross)	Cross, Also Cross Groove Joint used in Center Pre-Packed	
	Rear attach (u-bolt, clamp, etc.)	Straps & Belts	
Bearing	Type (plain, anti-friction)	Anti-Friction	
	Lubrication (fitting, prepack)	Pre-Packed	
Drive taken through (torque tube, arms or springs)		Propshaft Assembly	
Torque taken through (torque tube, arms or springs)		Torque Arm Assembly	

\* Centerline to centerline of universal joints, or to centerline of rear attachment.

# MVMA Specifications

Vehicle Line CAMARO  
 Model Year 1997 Issued \_\_\_\_\_ Revised (●) \_\_\_\_\_

## METRIC (U.S. Customary)

Engine Description **5.7 LITER V8 (350 CID)**  
 Engine Code **SEQUENTIAL FUEL INJECTION RPO LT1-**

### Axle Ratio and Tooth Combinations (See 'Power Teams' for axle ratio usage)

		AUTOMATIC - M30		MANUAL - M49
Axle ratio (or overall top gear ratio)		3.23 (2.03)	2.73 (1.91)	3.42
Ring gear o.d.		7.625 in.	7.625 in.	7.625 in.
No. of teeth	Pinion	13	15	12
	Ring gear	42	41	41

### Rear Axle Unit

Description		Salisbury/Beam Housing
Limited slip differential (type)		Cone Clutch
Drive pinion	Type	Hypoid
	Offset	38.1 (1.50)
No. of differential pinions		Two
Pinion / differential	Adjustment (shim, etc.)	Shim
	Bearing adjustment	Shim
Driving wheel bearing (type)		Cylindrical Roller Direct on Shafts, Drawn Cup
Lubricant	Capacity L (pt.)	1.66 (3.5)
	Type recommended	GM Lube #9985182 W/Two Ounces of #9985412

### Propeller Shaft - Rear Wheel Drive

Manufacturer		Straight Tube, Internal Damper and External Damper	
Type (straight tube, tube-in-tube, internal-external damper, etc.)			
Outer diam. x length* x wall thickness	Manual 4-speed transmission	Not Available	
	Manual 5-speed transmission	Not Available	
	Manual 6-speed transmission	63.5 x 1036.0 x 1.65 mm (2.5 x 40.8 x 0.065 in.)*	
	Overdrive		
Intermediate bearing	Automatic transmission	63.5 x 1057.0 x 1.65 mm (2.5 x 41.6 x 0.065 in.)*	
	Type (plain, anti-friction)	Not Available	
Slip yoke	Lubrication (fitting, prepack)	--	
	Type	Splined	
	Number of teeth	27 Teeth	
	Spline o.d.	29.87 mm (1.176 in.)	
Universal joints	Make and mfg. no.	Front	American Axle, S-44
		Rear	American Axle, S-44
	Number used	Two	
	Type (ball and trunion, cross)	Cross	
	Rear attach (u-bolt, clamp, etc.)	Strap & Bolt	
Bearing	Type (plain, anti-friction)	Anti-Friction	
	Lubrication (fitting, prepack)	Prepacked	
Drive taken through (torque tube, arms or springs)		Propeller Shaft Assembly	
Torque taken through (torque tube, arms or springs)		Torque Arm Assembly	

\* Centerline to centerline of universal joints, or to centerline of rear attachment.

# MVMA Specifications

Vehicle Line CAMARO  
 Model Year 1997 Issued \_\_\_\_\_ Revised (●) \_\_\_\_\_

## METRIC (U.S. Customary)

Model Code/Description And/Or  
 Engine Code/Description

ALL

### Suspension - General Including Electronic Controls

Car leveling	Standard/optional/not available	Not Applicable	
	Manual/automatic control	Not Applicable	
	Type (air/hydraulic)	Not Applicable	
	Primary/assist spring	Not Applicable	
	Rear only/4 wheel leveling	Not Applicable	
	Single/dual rate spring	Not Applicable	
	Single/dual ride heights	Not Applicable	
	Provision for jacking	Jacking Provisions on Rocker Panels	
Shock absorber damping controls	Standard/option/not available	Not Applicable	
	Manual/automatic control	Not Applicable	
	Number of damping rates	Not Applicable	
	Type of actuation (manual/electric motor/air, etc.)	Not Applicable	
	Sensors	Lateral acceleration	Not Applicable
		Deceleration	Not Applicable
Acceleration		Not Applicable	
Road surface		Not Applicable	
Shock absorber (front & rear)	Type	Direct, Monotube, Hydraulic with High Pressure Gas Charge	
	Make	Delphi - E/DeCarbon	
	Piston diameter	46 mm (1.81 in.), Front; 36 mm (1.42 in.), Rear; 46 mm (1.81 in.), Rear 1LE	
	Rod diameter	14 mm (0.55 in.), Front; 11 mm (0.43 in.), Rear	

### Suspension - Front

Type and description		Independent w/Coil Springs, SLA (With Coil Over Shock) Gas-Charged Shocks
Travel	Full jounce (define load condition)	Maximum Effective Jounce from Curb, 93.5 mm (3.68 in.)
	Full rebound	Maximum Effective Rebound from Curb, 91.5 mm (3.60 in.)
Spring	Type (coil, leaf, other & material)	Coil, Steel
	Insulators (type & material)	Rubber (Top, Integral Part of Top Mount, Plastic Bottom)
	Size (Leaf: length & width; Coil: design height & i.d.; Bar: length & diameter)	250.7 mm Checking Height 85.0 I.D.
	Spring rate N/mm (lb./in.)	39 (223), Base; 51 (291), Z28; 63 (360), 1LE
	Rate at wheel N/mm (lb./in.)	Spring Rate x (0.346)
Stabilizer	Type (link, linkless, frameless)	Link
	Material & O.D. bar/tube, wall thickness	Tubular Steel - 30 mm (1.18 in.) O.D. Painted; 4.5 mm Wall (32 mm for 1LE)

### Suspension - Rear

Type and description		Salisbury Axle w/Torque Arm, Trailing Arm, Track Bar, Coil Springs	
Travel	Full jounce (define load condition)	108.0 mm From Curb	
	Full rebound	85.0 mm From Curb	
Spring	Type (coil, leaf, other & material)	Coil-Steel	
	Size (Leaf: length & width; Coil: design height & i.d.; Bar: length & diameter)	248.2 mm Checking Height 108.0 I.D.	
	Spring rate N/mm (lb./in.)	16.7 (95.4), Base; 19.9 (113.7), Z28; 23-30 (131-171) Variable Rate, 1LE	
	Rate at wheel N/mm (lb./in.)	0.97 x Spring Rate	
	Insulators (type & material)	Rubber Isolated	
	If leaf	No. of leaves	Not Applicable
		Shackle (comp. or tens.)	"
Stabilizer	Type (link, linkless, frameless)	Link	
	Material & O.D. bar/tube, wall thickness	Steel, 17.0 mm O.D. Base; 19.0 mm O.D. Z28; 19 mm for 1LE	
Track bar (type)		"U" Section w/ Rubber Bushings	

# MVMA Specifications

Vehicle Line CAMARO  
 Model Year 1997 Issued \_\_\_\_\_ Revised (●) \_\_\_\_\_

## METRIC (U.S. Customary)

Model Code/Description And/OR  
 Engine Code/Description

BASE

### Brakes - Service

Description		Single Caliper Disc Front, Duo-Servo Drum Rear			
Manufacturer and brake type (std., opt., n.a.)	Front (disc or drum)	Disc			
	Rear (disc or drum)	Drum			
Valving type (proportion, delay, metering, other)		Remote Proportioning, Front/Rear Split, Failure Warning			
Power brake (std., opt., n.a.)		Standard			
Booster type (remote, integral, vac., hyd., etc.)		Compact Tandem Vacuum, 220 mm (8.7 in.)			
Vacuum	Source (inline, pump, etc.)	Inline			
	Reservoir (volume in. <sup>3</sup> )	Not Available			
	Pump type (elec., gear or belt driven)	Not Available			
Traction assist	Operational speed range	Not Available			
	Type (engine or brake intervention)	Not Available			
Antilock device	Front/rear (std., opt., n.a.)	Standard			
	Manufacturer	Delphi Chassis systems			
	Type (electronic, mech.)	Electro-Mechanical			
	Number sensors or circuits	Three			
	Number antilock hydraulic circuits	Three			
	Integral or add-on system	Remote Add-On			
	Yaw control (yes, no)	Yes (In Software)			
Hyd. power source (elec., vac., mtr., pwr., strg.)		Motor Driven			
Effective area cm <sup>2</sup> (in. <sup>2</sup> )*		Total: 672.7 (104.3) = F/243.6 (37.8) & R/429.1 (66.5)			
Gross Lining area cm <sup>2</sup> (in. <sup>2</sup> )** (F/R)		Total: 690.1 (107.0) = F/243.6 (37.8) & R/446.5 (69.2)			
Swept area cm <sup>2</sup> (in. <sup>2</sup> )** (F/R)		Total: 2110 (327) = F/1340 (208) & R/770 (119)			
Rotor	Outer working diameter	F/R	F/271 mm (10.7 in.)		
	Inner working diameter	F/R	F/175.6 mm (6.9 in.)		
	Thickness	F/R	F/32.0 mm (1.26 in.)		
	Material & type (vented/solid)	F/R	Cast Iron, Vented Front		
Drum	Diameter & width	F/R	R/241.0 mm (9.5 in.) x 50.8 mm (2.0 in.)		
	Type and material	F/R	R/Cast Iron Finned		
Wheel cylinder bore		F/63.5 mm (2.5 in.) Disc; R/20.6 mm (0.81 in.) Drum			
Master cylinder	Bore/stroke	F/R	Bore: 25.4 mm (1.0 in.)		
Pedal arc ratio		3.25:1			
Line press. at 445 N (100 lb.) pedal load [kPa (psi)]					
Lining clearance		F/R	Self-Adjusting/Self-Adjusting		
Brake lining	Front wheel	Bonded or riveted (rivets/seg.)		Bonded	
		Rivet Size		Not Available	
		Manufacturer		Delphi Chassis (Drum)	
		Lining code *****		DM-8100 (DM 130 EE)	
		Material		Semi-Metallic	
		****	Primary or out-board	13.6 x 4.7 x 1.1 cm. (5.35 x 1.84 x 0.430 in.)	
		Size	Secondary or in-board	12.4 x 4.85 x 1.2 cm. (4.88 x 1.91 x 0.480 in.)	
	Shoe thickness (no lining)		4.85 mm (0.191 in.)		
	Rear wheel	Bonded or riveted (rvts/seg.)		Riveted (Drum)	
		Manufacturer		Delphi Chassis (Drum)	
		Lining code *****		4064 (Delphi 241 FF)	
		Material		Semi-Metallic	
		****	Primary or out-board	18.4 x 5.1 x 0.56 cm. (7.23 x 0.22 x 1.99 in.)	
		Size	Secondary or in-board	24.0 x 5.1 x 0.74 cm. (9.44 x 0.29 x 1.99 in.)	
Shoe thickness (no lining)		Drum 1.98 mm (0.078 in.)			

\* Excludes rivet holes, grooves, chamfers, etc. \*\* Includes rivet holes, grooves, chamfers, etc.  
 \*\*\* Total swept area for four brakes. (Drum brake: Widest lining contact width for each brake x its contact circumference.)  
 (Disc brake: Square of Outer Working Dia. minus Square of inner Working Dia. multiplied by Pi/2 for each brake.)  
 \*\*\*\* Size for drum brakes includes length x width x thickness. \*\*\*\*\* Manufacturer I.D., catalog for formulation designation and coefficient of friction classification.

# MVMA Specifications

Vehicle Line CAMARO  
 Model Year 1997 Issued \_\_\_\_\_ Revised (●) \_\_\_\_\_

## METRIC (U.S. Customary)

Model Code/Description And/Or  
 Engine Code/Description

Z28

### Brakes - Service

Description		Front & Rear Disc Brakes			
Manufacturer and brake type (std., opt., n.a.)	Front (disc or drum)	Disc			
	Rear (disc or drum)	Disc			
Valving type (proportion, delay, metering, other)		Remote Proportioning Front/Rear Split, Failure Warning			
Power brake (std., opt., n.a.)		Standard			
Booster type (remote, integral, vac., hyd., etc.)		Compact Tandem Vacuum, 220 mm (8.7 in.)			
Vacuum	Source (inline, pump, etc.)	Inline			
	Reservoir (volume in. <sup>3</sup> )	Not Applicable			
	Pump-type (elec., gear or belt driven)	Not Applicable			
Traction assist	Operational speed range	Optional - 0 KPH (0 MPH), 175 KPH (108 MPH)			
	Type (engine or brake intervention)	Brake Intervention, Throttle Pull-Back, and Spark Retard			
Antilock device	Front/rear (std., opt., n.a.)	Standard			
	Manufacturer	Delphi Chassis Systems			
	Type (electronic, mech.)	Electr-Mechanical			
	Number sensors or circuits	Three (Four W/Optional Traction Control)			
	Number antilock hydraulic circuits	Three			
	Integral or add-on system	Remote Add-On			
	Yaw control (yes, no)	Yes (In Software)			
Hyd. power source (elec., vac., str., pwr., strp.)		Motor Driven			
Effective area cm <sup>2</sup> (in. <sup>2</sup> )*		Total: 362.4 (56.2) = F/243.6 (37.8) & R/106.8 (16.6)			
Gross Lining area cm <sup>2</sup> (in. <sup>2</sup> )** (F/R)		Total: 362.4 (56.2) = F/243.6 (37.8) & R/118.8 (18.4)			
Swept area cm <sup>2</sup> (in. <sup>2</sup> )*** (F/R)		Total: 2464 (382) = F/1340 (208) & R/1124 (174)			
Rotor	Outer working diameter	F/R	F/271.0 mm (10.7 in.); R/289.5 mm (11.4 in.)		
	Inner working diameter	F/R	F/175.6 mm (6.9 in.); R/219.0 mm (8.62 in.)		
	Thickness	F/R	F/32.0 mm (1.26 in.); R/20.0 (0.8 in.)		
	Material & type (vented/solid)	F/R	F/Cast Iron Vented; R/Composite Cast Iron Vented		
Drum	Diameter & width	F/R	Not Applicable		
	Type and material	F/R	Not Applicable		
Wheel cylinder bore		F/63.5 mm (2.5 in.), Disc; R/40.5 mm (1.6 in.), Disc			
Master cylinder	Bore/stroke	F/R	Bore: 25.4 mm (1.0 in.)		
Pedal arc ratio		3.25:1			
Line press. at 445 N (100 lb.) pedal load [kPa (psi)]		-			
Lining clearance		F/R	Self-Adjusting/Self-Adjusting		
Brake lining	Front wheel	Bonded or riveted (rivets/seg.)		Integrally Molded	
		Rivet Size		Not Applicable	
		Manufacturer		Delphi Chassis Systems	
		Lining code *****		DM-8100 (DM 130 EE)	
		Material		Semi-Metallic	
		****	Primary or out-board	13.6 x 4.7 x 1.1 cm. (5.35 x 1.84 x 0.430 in.)	
		Size	Secondary or in-board	12.4 x 4.85 x 1.2 cm (4.88 x 1.91 x 0.480 in.)	
	Shoe thickness (no lining)		4.85 mm (0.191 in.)		
	Rear wheel	Bonded or riveted (rvts/seg.)		Integrally Molded	
		Manufacturer		Japan Brake Industries	
		Lining code *****		HB33 (JB B33 GF)	
		Material		Semi-Metallic	
		****	Primary or out-board	10.8 x 3.53 x 0.825 cm. (4.25 x 1.39 x 0.324 in.)	
		Size	Secondary or in-board	9.45 x 3.53 x 0.825 cm. (3.72 x 1.39 x 0.324 in.)	
Shoe thickness (no lining)		IB 5.5 mm (.21 in.) OB 4.0 mm (.16 in.)			

\* Excludes rivet holes, grooves, chamfers, etc. \*\* Includes rivet holes, grooves, chamfers, etc.  
 \*\*\* Total swept area for four brakes. (Drum brake: Widest lining contact width for each brake x its contact circumference.)  
 (Disc brake: Square of Outer Working Dia. minus Square of inner Working Dia. multiplied by Pi/2 for each brake.)  
 \*\*\*\* Size for drum brakes includes length x width x thickness. \*\*\*\*\*Manufacturer I.D., catalog for formulation designation and coefficient of friction classification.

# MVMA Specifications

Vehicle Line CAMARO  
 Model Year 1997 Issued \_\_\_\_\_ Revised (●) \_\_\_\_\_

## METRIC (U.S. Customary)

Model Code/Description And/Or  
 Engine Code/Description

BASE	Z28
------	-----

### Tires And Wheels (Standard)

Tires	Size (service description)		P215/60R-16	P235/55R16
	Type (bias, radial, steel, nylon, etc.)		Steel Belted Radial Touring Tire	Steel Belted Radial Touring Tire
	Inflation pressure (cold) for recommended max. vehicle load	Front kPa (psi)	210 (30)	210 (30)
		Rear kPa (psi)	210 (30)	210 (30)
	Rev./mile at 70 km/h (45 mph)		495	495
Wheels	Type & material		Steel	Cast Aluminum
	Rim (size & flange type)		16 x 7.5 J	16 x 8 J
	Wheel offset		55 mm	55 mm
	Attachment	Type (bolt or stud & nut)	Stud	Stud
		Circle diameter	120.7 mm (4.75 in.)	120.7 mm (4.75 in.)
		Number & size	5-M12 x 1.5 - 6H - thd. (Metric)	5-M12 x 1.5 - 6H - thd. (Metric)
Spare	Tire and wheel		15 x 4 T125/70D15, Compact Spare	15 x 4 T125/70D15, Compact Spare
	Storage position & location (describe)		Vertically Adjacent to R.H. Quarter Panel	Vertically Adjacent to R.H. Quarter Panel

### Tires And Wheels (Optional)

Tire size (service description)		P235/55R16	P245/50ZR16 * (+)
Type (bias, radial, steel, nylon, etc.)		Steel Belted Radial Touring Tire	Stl. Bltd. Radial Hwy. Hi-Prfmc.
Wheel (type & material)		Cast Aluminum	Hi-Performance, Cast Aluminum
Rim (size, flange type and offset)		16 x 8 J, 55 mm	16 x 8 J, 55 mm
Tire size (service description)			@ P245/50ZR16 AL3
Type (bias, radial, steel, nylon, etc.)			Steel Bltd. Radial Hwy Hi-Perf.
Wheel (type & material)			Hi-Performance Cast Aluminum
Rim (size, flange type and offset)			16 x 8 J, 55 mm
Tire size (service description)			
Type (bias, radial, steel, nylon, etc.)			
Wheel (type & material)			
Rim (size, flange type and offset)			
Tire size (service description)			
Type (bias, radial, steel, nylon, etc.)			
Wheel (type & material)			
Rim (size, flange type and offset)			
Spare tire and wheel size			
(if configuration is different than road tire or wheel, describe optional spare tire and/or wheel location & storage position)			

### Brakes - Parking

Type of control		Hand Lever Application - Push Button Release - Self-Adjusting
Location of control		Right Side of Floor Console
Operates on		
If separate from service brakes	Type (internal or external)	-
	Drum diameter	-
	Lining size (length x width x thickness)	-

@ Recommended with NW9 Acceleration Slip Regulation (AL3 - All Season Performance) 505 Rev/Mile at 70 km/h (45 mph)

(\*) Directional Tread, Asymmetrical (+) Non "All Season" Tire 505 Rev/Mile at 70 km/h (45 mph)



# MVMA Specifications

Vehicle Line CAMARO  
 Model Year 1997 Issued \_\_\_\_\_ Revised (●) \_\_\_\_\_

## METRIC (U.S. Customary)

Model Code/Description And/Or  
 Engine Code/Description

SPORT COUPE	Z28
-------------	-----

### Steering

Manual (std., opt., n.a.)		Not Available		
Power (std., opt., n.a.)		Standard		
Speed-sensitive (std., opt., n.a.)		Not Available		
4-wheel steering (std., opt., n.a.)		Not Available		
Adjustable steering wheel/column (tilt, telescope, other)	Type	Tilt, Five Position		
	Manufacturer	Delphi Saginaw Strg. System		
	(std., opt., n.a.)	Standard		
Wheel diameter** (W9) SAE J1100	Manual	Not Available		
	Power	375.0 mm (14.8 in.) Rim		
Turning diameter m (ft.)	Outside front	Wall to wall (l. & r.)	(A)	
		Curb to curb (l. & r.)	(B)	
	Inside rear	Wall to wall (l. & r.)	(C)	
		Curb to curb (l. & r.)	(D)	
Scrub Radius*		Not Applicable		
Manual	Gear	Type	Not Applicable	
		Manufacturer	Not Applicable	
		Ratios	Not Applicable	
		Overall	Not Applicable	
	No. wheel turns (stop to stop)		Not Applicable	
Power	Type (coaxial, elec. hyd., etc.)		Hydraulic	
	Manufacturer		Delphi Saginaw Strg. System	
	Gear	Type	Rack & Pinion	
		Ratios	Overall	16.9:1 W/F41 14.4:1 W/FE2
		Pump (drive)		Belt
	No. wheel turns (stop to stop)		2.67 W/F41 2.28 W/FE2	
Linkage	Type		End Take-Off Rack & Pinion	
	Location (front or rear of wheels, other)		Front	
	Tie rods (one or two)		Two	
Steering axis	Inclination at camber (deg.)		Not Available	
	Bearings (type)	Upper	Ball Stud	
		Lower	Ball Stud	
		Thrust	Not Available	
Steering spindle/knuckle & joint type		Steering Knuckle W/Spherical Joints		

\* The horizontal distance in the front elevation between wheel centerline and kingpin (ball joint) axis at ground.

\*\* See Page 23.

#### TURNING DIAMETER:

CAMARO

Z28

	LEFT	RIGHT	LEFT	RIGHT
A)	12.14 m (39' 10") /	12.9 m (42' 5-1/2")	12.08 m (39' 7-1/2") /	12.78 m (41' 11")
B)	11.56 m (37' 11-1/8") /	12.39 m (40' 7-5/8")	11.52 m (37' 9-5/8") /	12.22 m (40' 1-1/8")
C)	6.77 m (22' 2-1/2") /	7.67 m (25' 2")	6.72 m (22' 1/2") /	7.43 m (24' 4-1/2")
D)	6.88 m (22' 6-15/16") /	7.77 m (25' 5-15/16")	6.79 m (22' 3-1/2") /	11.52 m (37' 9-5/8")

# MVMA Specifications

Vehicle Line CAMARO  
 Model Year 1997 Issued \_\_\_\_\_ Revised (●) \_\_\_\_\_

## METRIC (U.S. Customary)

Model Code/Description And/Or  
 Engine Code/Description

ALL

### Wheel Alignment

(Assume Measurements are Done on Hunter Equipment or Equivalent)

Front wheel at curb mass (wt.)	Service checking	Caster (deg.)	+4.4 (±) 0.5 Cross Within 0.7
		Camber (deg.)	+0.4 (±) 0.5 Cross Within 0.7
		Toe-in outside track mm (in.)	0.0 (±) 0.2
	Service reset*	Caster (deg.)	+4.4 (±) 0.5 Cross Within 0.5
		Camber (deg.)	+0.4 (±) 0.5 Cross Within 0.5
		Toe-in mm (in.)	0.0 (±) 0.1
Periodic M.V. in-spection	Caster (deg.)	+4.4 (±) 0.5	
	Camber (deg.)	+0.4 (±) 0.5	
	Toe-in mm (in.)	0.0 (±) 0.2	
Rear wheel at curb mass (wt.)	Service checking	Camber (deg.)	Not Serviceable
		Toe-in outside track mm (in.)	Not Serviceable
	Service reset*	Camber (deg.)	Not Serviceable
		Toe-in mm (in.)	Not Serviceable
	Periodic M.V. insp.	Camber (deg.)	Not Serviceable
		Toe-in mm (in.)	Not Serviceable

\* Indicates pre-set, adjustable, trend set or other.

### Electrical - Instruments and Equipment

Speedometer	Type (analog, digital, std., opt.)	Analog, Standard	
	Trip odometer (std., opt., n.a.)	Standard (New LCD for Season & Trip Odo.	
Heated-up display	Standard, optional, not available		Not Applicable
	Type	Secondary, opto-electronic	Not Applicable
	Speedometer	Digital	Not Applicable
	Status/warning indicators	Turn signals, high beam, low fuel, check gauges	Not Applicable
	Brightness control	Day / night mode, adjustable	Not Applicable
EGR maintenance indicator		Not Available	
Charge indicator	Type	Analog Gage, Standard	
	Warning device (light, audible)	Check Gages Telltale	
Temperature indicator	Type	Analog Gage, Standard	
	Warning device (light, audible)	Check Gages Telltale	
Oil pressure indicator	Type	Analog Gage, Standard	
	Warning device (light, audible)	Check Gages Telltale	
Fuel indicator	Type	Analog Gage, Standard	
	Warning device (light, audible)	Not Available	
Windshield wiper	Type (standard)	Standard - Intermittent Pulse	
	Type (optional)	Not Available	
	Blade length	24 in.	
	Swept area cm <sup>2</sup> (in. <sup>2</sup> )	7154.8 (1109)	
Windshield washer	Type (standard)	Manual Control	
	Type (optional)	Not Available	
	Fluid level indicator (light, audible)	Not Available	
Rear window wiper, wiper/washer (std., opt., n.a.)		Not Available	
Horn	Type	"High" Note and "Low" Note Diaphragm Type	
	Number used	Two	
Other			

# MVMA Specifications

Vehicle Line CAMARO  
 Model Year 1997 Issued \_\_\_\_\_ Revised (●) \_\_\_\_\_

## METRIC (U.S. Customary)

Engine Code/Description 3.8 LITER V6 (231 CID)  
 SEQUENTIAL FUEL INJECTION RPO L36

### Electrical - Supply System

Battery	Manufacturer	Delphi - E
	Model, std., (opt.)	75-690, Standard, 19000674, Cat # 674
	Voltage	12
	Amps at 0° F. cold crank	690
	Minutes-reserve capacity	90 Min. @ 80° F
	Amps/hrs.-20 hr. rate	54 Amp Hrs.
Location		Engine Compartment Front Right Corner
Alternator	Manufacturer	Delphi - E CS130D
	Rating (idle/max. rpm)	105 Amps
	Ratio (alt. crank/rev.)	2.75 to One
	Output at idle (rpm, park)	42 Amps @ Idle
	Optional (type & rating)	Not Available
Regulator	Type	DR 1116429 Integral Part of Alternator

### Electrical - Starting System

Motor	Manufacturer	Delphi - E
	Current drain _____ °C (°F)	450 Amps
	Power rating kw (hp)	1.7 (2.3)
Motor drive	Engagement type	Solenoid with Mechanical Linkage
	Pinion engages from (front, rear)	Front

### Electrical - Ignition System

Type	Electronic (std., opt., r. ...)	Standard	
	Other (specify)	Not Available	
Coil	Manufacturer	Delphi - E	
	Model	Inductive	
	Current	Engine stopped - A	Not Applicable
		Engine idling - A	Not Applicable
Spark plug	Manufacturer	AC	
	Model	41-921	
	Thread (mm)	14 mm	
	Tightening torque N-m (lb. ft.)	10-20 N-m (7-15)	
	Gap	1.52 mm (0.60 in.)	
	Number per cylinder	One	
Distributor	Manufacturer	Not Applicable	
	Model	Not Applicable	

### Electrical - Suppression

Locations & type	Alternator - Internal Capacitor Suppression
------------------	---

# MVMA Specifications

Vehicle Line CAMARO  
 Model Year 1997 Issued \_\_\_\_\_ Revised (●) \_\_\_\_\_

## METRIC (U.S. Customary)

Engine Code/Description

5.7 LITER V8 (350 CID)  
 SEQUENTIAL FUEL INJECTION RPO LT1-

### Electrical - Supply System

Battery	Manufacturer	Delphi - E
	Model, std., (opt.)	75-525, Standard 19000670 Cat. # 670
	Voltage	12
	Amps at 0° F. cold crank	525
	Minutes-reserve capacity	90 min. @ 80. deg. F.
	Amps/hrs. -20 hr. rate	54 Amp Hrs.
	Location	Engine Compartment Front Right Corner
Alternator	Manufacturer	Delphi - E, CS144
	Rating (idle/max. rpm)	140 Amps
	Ratio (alt. crank/rev.)	2.93 :1
	Output at idle (rpm, park)	50 Amps @ Idle
Optional (type & rating)	Not Applicable	
Regulator	Type	Delphi - E #1116429 Integral Part of Alternator

### Electrical - Starting System

Motor	Manufacturer	Delphi - E
	Current drain _____ °C (°F)	400 AMPS
	Power rating kw (hp)	1.6 (2.1)
Motor drive	Engagement type	Positive Shift Solenoid
	Pinion engages from (front, rear)	Rear

### Electrical - Ignition System

Type	Electronic (str1 opt., n.a.)	Standard	
	Other (specify)	Opti-Spark Ignition System	
Coil	Manufacturer	Delphi - E	
	Model	1106011	
	Current	Engine stopped - A	
		Engine idling - A	
Spark plug	Manufacturer	AC	
	Model	R45LTSP	
	Thread (mm)	M14 x 1.25	
	Tightening torque N-m (lb. ft.)	24-30 (18-22)	
	Gap	1.27 mm (0.50 in.)	
	Number per cylinder	One	
Distributor	Manufacturer	Delphi - E	
	Model	1103878	

### Electrical - Suppression

Locations & type	Internal Generator Capacitor, Non-Metallic High-Tension Cables, Resistor Spark Plugs, Ignition Coil By-Pass Capacitor, Internal AC Blower Motor By-Pass Capacitor & A/C Compression Diode, with Radio Provisions; Fuse Block Capacitor and on "Heater Only" Blower Motors and Coax Capacitor.
------------------	---

# MVMA Specifications

Vehicle Line CAMARO  
 Model Year 1997 Issued Revised (●)

## METRIC (U.S. Customary)

Model Code/Description

ALL

### Body

Structure	Full Unitized Steel Construction with Composite Closures, Fenders and Roof Outer Skin. Cowl, Roof Substructure, Underbody and Body Side Frame Welded to Form Body Shell. Doors, Roof Substructure, Hood and Latch Lid Double Panel Construction.
Bumper system front - rear	Body Color Soft Fascia, Honeycomb Absorber and Heavy Gauge Reinforcement Used Front and Rear.
Anti-corrosion treatment	Plastic Composite Panels, Two Sided Galvanized Metals and ELPO Coverage

### Body - Miscellaneous Information

Type of finish (lacquer, enamel, other)	Waterborne Base Coat/Clear Coat	
Hood	Material & mass	Steel
	Hinge location (front, rear)	Rear
	Type (counterbalance, prop)	Gas Strut Assist
	Release control (internal, external)	Internal
Trunk lid	Material & mass	Not Applicable
	Type (counterbalance, other)	Not Applicable
	Internal release control (elec., mech., n.a.)	Not Applicable
Hatchback lid	Material & mass	Glass/Sheet Molding Compound (SMC)
	Type (counterbalance, other)	Dual Gas Struts
	Internal release control (elec., mech., n.a.)	Electric Release Optional
Tailgate	Material & mass	Not Applicable
	Type (drop, lift, door)	Not Applicable
	Internal release control (elec., mech., n.a.)	Not Applicable
Vent window control (crank, friction, pivot, power)	Front	Not Available
	Rear	Not Applicable
Window regulator type (cable, tape, flex drive, etc.)	Front	Sector Drive
	Rear	Not Applicable
Seat cushion type (e.g., 60/40 bucket, bench, wire, foam, etc.)	Front	Bucket Molded Foam Pad
	Rear	Bucket Molded Foam Pad
	3rd seat	--
Seat back type (e.g., 60/40 bucket, bench, wire, foam, etc.)	Front	Reclining Bucket Molded Foam Pad
	Rear	Folding Bench, Mechanical Foam Pad
	3rd seat	--

### Frame

Type and description (separate frame, unitized frame, partially-unitized frame)	Full Integral Body Frame. Includes Bolted on Front Suspension Crossmember.
---	--

# MVMA Specifications

Vehicle Line CAMARO  
 Model Year 1997 Issued \_\_\_\_\_ Revised (●) \_\_\_\_\_

## METRIC (U.S. Customary)

Model Code/Description

ALL

### Restraint System

Seating Position			Left	Center	Right
Active	Type & description (lap & shoulder belt, lap belt, etc.)  Standard / Optional	First seat	Lap and Shoulder Belt, Standard	Not Applicable	Lap and Shoulder Belt, Standard
		Second seat	Lap and Shoulder Belt, Standard	Not Applicable	Lap and Shoulder Belt, Standard
		Third seat	Not Applicable	Not Applicable	Not Applicable
Passive	Type & description (air bag, motorized-2-point belt, fixed belt, knee bolster, manual-lap belt)  Standard / Optional	First seat	Air Bag, Knee Bolster, Standard	Not Applicable	Air Bag, Knee Bolster, Standard
		Second seat	Not Applicable	Not Applicable	Not Applicable
		Third seat	Not Applicable	Not Applicable	Not Applicable
<b>Glass</b>		<b>SAE Ref.No.</b>	<b>Coupe</b>		<b>Convertible</b>
Windshield glass exposed surface area cm <sup>2</sup> (in. <sup>2</sup> )		S1	14,182.58 (2,198.30)		
Side glass exposed surface area cm <sup>2</sup> (in. <sup>2</sup> ) - total 2 sides		S2	3,150.29 (488.295)		
Backlight glass exposed surface area cm <sup>2</sup> (in. <sup>2</sup> )		S3	13,936.41 (2,160.15)		2,268 (353.3)
Total glass exposed surface area cm <sup>2</sup> (in. <sup>2</sup> )		S4	31,269.28 (4,846.745)		19,600.87 (3,039.895))
Windshield glass (type/thickness)			Curved - Laminated Plate		
Side glass (type/thickness)			Curved - Tempered Plate		
Backlight glass (type/thickness)			Curved - Tempered Plate		Glass
Tinted (yes/no, location)			No		
Solar control (yes/no, coated/batched, location)			Yes, Batch, Windshield, Door Glass & Rear Hatch Glass		

### Headlamps

Description (sealed beam, halogen, replaceable bulb, etc.)	Halogen, Replaceable Bulb - Four Lamp System
Shape	Rectangular
Lo-beam type (2A1, 2B1, 2C1, etc.)	H4351
Quantity	Two
Hi-beam type (1A1, 2A1, 1C1, 2C1, etc.)	H4352
Quantity	Two

# MVMA Specifications

Vehicle Line CAMARO  
 Model Year 1997 Issued \_\_\_\_\_ Revised (#) \_\_\_\_\_

## METRIC (U.S. Customary)

Engine Code/Description

LT1 ENGINE ONLY

### Climate Control System

Air conditioning (std., opt., man., auto.)		Optional
Condenser	Type	Headered Tube & Center
	Eff. face area (sq. mm.)	246,519 sq. mm
	Fins per inch	16.93
Evaporator	Type	Tube - Plate & Fin
	Eff. face area (sq. mm.)	46,141.9
	Fins per inch	14
Heater core	Material	Aluminum
	Eff. face area (sq. mm.)	30,864.7 sq. mm
	Fins per inch	38
Compressor	Type	HD 6 Cylinder
	Displacement (cc.)	10.0
	Manufacturer	Delphi Hamison Thermal Systems
	A/C pulley ratio	1.50:1 (Auto), 1.50:1 (Manual)
Accumulator	Type	Not Available
	Height (mm.)	Not Available
	Diameter (mm.)	Not Available
Receiver	Type	Aluminum
	Height (mm.)	169.0 mm
	Diameter (mm.)	76.5 mm
Refrigerant control (CCOT, TVS, etc.)		TXV Thermal Exposure
Heater water valve (yes / no)		No
Refrigerant (R - 12, R - 134a, etc.)		R134A
Charge level (lbs. - oz.)		2.0 lbs.
Cold engine lockout switch (yes / no)		No
Wide open throttle cutout switch (yes / no)		Yes

# MVMA Specifications

Vehicle Line CAMARO  
 Model Year 1997 Issued \_\_\_\_\_ Revised (●) \_\_\_\_\_

## METRIC (U.S. Customary)

Engine Code/Description

L36 (3800) ENGINE ONLY

### Climate Control System

Air conditioning (std., opt., man., auto.)		Optional
Condenser	Type	Headered Tube & Center
	Eff. face area (sq. mm.)	246,519 sq. mm
	Fins per inch	16.93
Evaporator	Type	Tube - Plate & Fin
	Eff. face area (sq. mm.)	46,141.9
	Fins per inch	14
Heater core	Material	Aluminum
	Eff. face area (sq. mm.)	30,864.7 sq. mm
	Fins per inch	38
Compressor	Type	HD 5 Cylinder Variable Displacement
	Displacement (cc.)	9.2
	Manufacturer	Delphi HarrisonThermal Systems
	A/C pulley ratio	Base 1.47:1
Accumulator	Type	Aluminum
	Height (mm.)	205.8 mm
	Diameter (mm.)	92.8 mm
Receiver	Type	Not Available
	Height (mm.)	Not Available
	Diameter (mm.)	Not Available
Refrigerant control (CCOT, TVS, etc.)		V5/OT
Heater water valve (yes / no)		No
Refrigerant (R - 12, R - 134a, etc.)		R134A
Charge level (lbs. - oz.)		1.62 lbs.
Cold engine lockout switch (yes / no)		No
Wide open throttle cutout switch (yes / no)		Yes



# MVMA Specifications

Vehicle Line CAMARO  
 Model Year 1997 Issued \_\_\_\_\_ Revised (●) \_\_\_\_\_

## METRIC (U.S. Customary)

Model Code/Description

ALL

### Convenience Equipment (standard, optional, n.a.)

	Clock (digital, analog)	Digital, In Radio
	Compass / thermometer	Not Available
	Console (floor, overhead)	Full Lenth Frt. Console, Std. Floor Integral with I.P., Overhead Not Avail.
	Defroster, electric windshield	Not Applicable
	Defroster, electric backlight	Electric - Optional; Std. on Convertible
Electronic	Diagnostic monitor (integrated, individual)	Not Available
	Instrument cluster (list instruments)	Tachometer, Speedometer, Trip Opdometer, Fuel, Oil Pressure, Temp Volt, Seat Belt Warning, Engine Warning, Inflatable Restraint Warning
	Remote Keyless entry (FOB)	Optional
	Tripminder (avg. spd., fuel)	Not Available
	Voice alert (list items)	Not Available
	Other Warning Lamps	Check Gauges, Low Oil, ABS/Brake, Bright Headlamps, Air Bag, Low Coolant (V8's only), Low Trac, Security, Service Engine Soon, Seat Belt, Skip Shift (Manual V8's Only), TCS (Traction Control Option - V8's Only)
	Fuel door lock (remote, key, electric)	Not Available
Integrated Child Seating	Std./opt. & location in vehicle	
	Number of occupants	
	Occupant weight/height (min. & max.)	
	Restraint system description (3 or 5-point belts/booster seat capability)	
Lamps	Auto head on/off delay, dimming	Not Available
	Cornering	Not Available
	Courtesy (map, reading)	Dual Lighted Mirror, Standard; Includes Switch
	Door lock, ignition	Not Available
	Engine compartment	Not Available
	Fog	Optional
	Glove compartment	Standard
	Trunk	Standard on Convertible
	Illuminated entry system (list lamps, activation)	Courtesy (Reading ) Lamp, Coupe Rear Seat Courtesy Lamps & Courtesy (Reading ) Lamp, Convertible Optional Remote Lock Control w/Illuminated Entry Features
	Other	Flood Lighted Interior Door Switches
	Dome - Courtesy	Standard - Illuminates Rear Compartment, Coupe Only
Mirrors	Day / night (auto., man.)	Standard - Manual
	L.H. (remote, power, heated)	Remote Standard, Power Optional - Not Heated
	R.H. (convex, remote, power, heated)	Manual Standard, Power Optional. Both Convex - Not Heated
	Visor vanity (RH / LH, illuminated)	Covered LH & RH, Standard (Non-Illuminated)
	Navigation system (describe)	Not Available
	Parking brake-auto release (warning light)	Hand Release, Warning Light Standard

# MVMA Specifications

Vehicle Line CAMARO  
 Model Year 1997 Issued Revised (●)

## METRIC (U.S. Customary)

Model Code/Description

ALL

### Convenience Equipment (standard, optional, n.a.)

Power equipment	Deck lid (release, pull down)		Electric Hatch Release - Optional
	Door locks (manual, automatic, describe system)		Manual - Standard Electric - Optional; Includes Retained Accessory Power (RAP)
	Seats	2 - 4 - 6 way, etc.	Optional Six-Way Power Driver's Seat
		Reclining (R.H., L.H.)	Not Available
		Memory (R.H.,L.H., preset recline)	Not Available
		Support (lumbar, hip, thigh, etc.)	Not Available
		Heated (R.H., L.H., other)	Not Available
	Side windows		Optional - Retained Accessory Power (RAP) is Inc. W/Power Locks
	Vent windows		Not Available
	Rear windows		Not Available
		Not Available	
Radio systems	Antenna (location, whip, w/shield, power)		Right Rear Fender Fixed Mast Standard
	Standard	AM, FM, stereo, tape, compact disc, graphic equalizer, theft deterrent, radio prep package, headphone jacks, etc.	AM/FM Stereo Cassette W/Seek, Scan, Auto Reverse, Music Search, Digital Clock & ETR
	Optional		AM/FM Stereo Auto-Tone Cassette Radio w/dual directional seek, auto reverse, music search, digital clock, ETR and Dolby B & Speed compensated volume controls. AM/FM Stereo Radio Compact Disc, Pre-set scan, dual directional seek, random, digital clock, ETR, Balance control, with speed compensated volume control.
	Speaker (number, location)		Up-Level/Sound System, Eight channel amplifier with six high performance speakers: Dual Door Mounted, Dual Sail Panel & Dual hatch trim speakers.
Roof: open air or fixed (flip-up, sliding, "T")			"T" Type Hatch Roof W/Removeable Glass Panels - Optional
Speed control device			Cruise Control with Resume Speed, Optional
Speed warning device (light, buzzer, etc.)			Not Available
Tachometer (rpm)			Standard
Telephone system (describe)			Not Available
Theft deterrent system			Lock Mounted on Steering Column; Locked Steering Wheel, Transmission, Shift Lever and Ignition. Electronic System (PASS-KEY II) Standard. Retained Accessory Power (RAP) Standard on all vehicles
			Universal Theft Deterrent System Standard on Chevrolet W/Remote Keyless Entry

### Trailer Towing

Towing capable	Yes / No	Yes
Engine / transmission / axle	Std. / Opt.	Standard
Tow class (I, II, III)*	Std. / Opt.	Light
Max. gross trailer wgt. (lbs.)	Std. / Opt.	1000 lbs
Max. trailer tongue load (lbs.)	Std. / Opt.	100 lbs
Towing package available	Yes / No	No

\* Class I - 2,000 lbs.    Class II - 3,500 lbs.    Class III - 5,000 lbs.

# MVMA Specifications

Vehicle Line **CAMARO**  
 Model Year **1997** Issued Revised (●)

## METRIC (U.S. Customary)

### Vehicle Dimensions See Key Sheets for definitions

All dimensions to ground are for comparative purposes only. Dimensions are to be shown for all base body models of each vehicle line. SAE Ref. no. refers to the definition published in SAE Recommended Practice J1100 "Motor Vehicle Dimensions," unless otherwise specified.

Model Code/Description	SAE Ref. No.	COUPE & ALL	VERTICAL	VERTICAL
<b>Width</b>				
Tread (front)	W101	1542 (60.7)		
Tread (rear)	W102	1540 (60.6)		
Vehicle width	W103	1883 (74.1)		
Body width at SgRP (front)	W117	1849 (72.8)		
Vehicle width (front doors open)	W120	4195 (165.2)		
Vehicle width (rear doors open)	W121	—		
Tumble-home (degrees)	W122	32.0		
Outside mirror width	W410	1995 (78.5)		

### Length

Wheelbase	L101	2566 (101.1)
Vehicle length	L103	4908 (193.2)
Overhang (front)	L104	1150 (45.3)
Overhang (rear)	L105	1192 (46.9)
Upper structure length	L123	2993 (117.8)
Rear Wheel C/L "X" coordinate	L127	4138 (163.0)

### Height \*\*

Passenger distribution (front/rear)	PD1,2,3	Two/Two
Trunk/cargo load		**
Vehicle height	H101	1303 (51.3)
Cowl point to ground	H114	901 (35.5)
Deck point to ground	H138	Not Available
Rocker panel-front to ground	H112	172 (6.8)
Rocker panel-rear to ground	H111	181 (7.1)
Windshield slope angle (degrees)	H122	68.0
Backlight slope angle (degrees)	H121	73.5

### Ground Clearance \*\*

Front bumper to ground	H102	130 (5.1)
Rear bumper to ground	H104	348 (13.7)
Bumper to ground front at curb mass (wt.)	H103	251 (9.9)
Bumper to ground rear at curb mass (wt.)	H105	371 (14.6)
Angle of approach (degrees)	H106	21.2
Angle of departure (degrees)	H107	11.5
Ramp breakover angle (degrees)	H147	11.5
Axle differential to ground (front/rear)	H153	150 (5.9)
Min. running ground clearance	H156	111.6 (4.0)
Location of min. running ground clear.		Converter Shield, V8; Suspension Bolt, V6

\*\* All Vehicle Height And Ground Clearance Are Made Using EPA Loaded Vehicle Weight, Loading Conditions. EPA loaded vehicle weight is the base vehicle weight plus all coolant and fluids necessary for operation plus 100% of the fuel capacity, plus the weight of all options and accessories which weigh three pounds or more and which are sold on at least 33% of the car line, plus two occupants.

All linear dimensions are in millimeters (inches).

# MVMA Specifications

Vehicle Line CAMARO  
 Model Year 1997 Issued Revised (●)

## METRIC (U.S. Customary) Vehicle Dimensions

See Key Sheets for definitions

Model Code/Description	SAE Ref. No.	COUPE & ALL		CONVERTIBLE	
<b>Front Compartment</b>					
SgRP front "X" coordinate	L31	3050 (124.0)			
Effective head room	H61	944 (37.2)		975 (38.0)	
Max. effective leg room (accelerator)	L34	1092 (43.0)			
SgRP to heel point	H30	181 (7.1)			
SgRP to heel point	L53	910 (35.8)			
Back angle (degrees)	L40	26.5			
Hip angle (degrees)	L42	98.0			
Knee angle (degrees)	L44	132.7			
Foot angle (degrees)	L46	87.0			
Design H-point front travel	L17	198 (7.8)			
Normal driving & riding seat track trvl.	L23	178 (7.0)			
Shoulder room	W3	1458 (57.4)			
Hip room	W5	1340 (52.8)			
*** Upper body opening to ground	H50	1260 (49.6)			
Steering wheel maximum diameter**	W9	375 (14.8)			
Steering wheel angle (degrees)	H18	17.3			
Accel. heel pt. to steer. whl. cntr.	L11	548.4 (21.6)			
Accel. heel pt. to steer. whl. cntr.	H17	Not Available			
Undepressed floor covering thickness	H67	27 (1.1)			

Front Compartment Interior Dimensions are Measured with the Seating Reference Point (SgRP) \_\_\_\_\_ mm forward and \_\_\_\_\_ mm Upward of Rearmost Position.

### Rear Compartment

SgRP point couple distance	L50	638 (25.1)			
Effective head room	H63	897 (35.3)		990 (39.0)	
Min. effective leg room	L51	681 (26.8)			
SgRP (second to heel)	H31	201 (7.9)			
Knee clearance	L48	-76 (-3.0)			
Shoulder room	W4	1417 (55.8)		1104 (43.5)	
Hip room	W6	1129 (44.4)		1110 (43.7)	
*** Upper body opening to ground	H51	--			
Back angle (degrees)	L41	28.0			
Hip angle (degrees)	L43	71.0			
Knee angle (degrees)	L45	67.1			
Foot angle (degrees)	L47	115.2			
Depressed floor covering thickness	H73	18 (0.7)			

### Luggage Compartment

*** Usable luggage capacity L (cu. ft.)	V1	--			
*** Liftover height	H195	892 (35.1)			

### Interior Volumes (EPA Classification)

Vehicle class	Sub-Compact	
Interior volume index including trunk/cargo (cu. ft.)**	94.8 (53.1 Frt. + 28.8 Rr. + 12.9 Cargo)	88.2 (54.3 Frt. + 26.3 Rr. + 7.6 Cargo)
Trunk/cargo index (cu. ft.)	12.9	7.6

\* See page 14.

\*\* See definition page 33.

All linear dimensions are in millimeters (inches) unless otherwise noted.

\*\*\* EPA Loaded Vehicle Weight, Loading Conditions

# MVMA Specifications

Vehicle Line CAMARO  
 Model Year 1997 Issued \_\_\_\_\_ Revised (●) \_\_\_\_\_

## METRIC (U.S. Customary)

### Vehicle Dimensions

See Key Sheets for definitions

Model Code/Description

ALL

#### Station Wagon/MPV\* -Third Seat

SAE  
Ref.  
No.

(Not Applicable)

Seat facing direction	SD1	
SgRP couple distance	L85	
Shoulder room	W85	
Hip room	W86	
Effective leg room	L86	
Effective head room	H86	
SgRP to heel point	H87	
Knee clearance	L87	
Back angle (degrees)	L88	
Hip angle (degrees)	L89	
Knee angle (degrees)	L90	
Foot angle (degrees)	L91	

#### Station Wagon/MPV\* - Cargo Space

(Not Applicable)

Cargo length (open front)	L200	
Cargo length (open second)	L201	
Cargo length (closed front)	L202	
Cargo length (closed second)	L203	
Cargo length at belt (front)	L204	
Cargo length at belt (second)	L205	
Cargo width (wheelhouse)	W201	
Rear opening width at floor	W203	
Opening width at belt	W204	
Min. rear opening width above belt	W205	
Cargo height	H201	
Rear opening height	H202	
Tailgate to ground height	H250	
Front seat back to load floor height	H197	
Cargo volume index m <sup>3</sup> (ft. <sup>3</sup> )	V2	
Hidden cargo volume index m <sup>3</sup> (ft. <sup>3</sup> )	V4	
Cargo volume index-rear of 2-seat	V10	
Cargo volume index*	V6	
Cargo width at floor*	W500	
Maximum cargo height*	H505	

#### Hatchback - Cargo Space

Cargo length at front seatback height	L208	990 (39.0)
Cargo length at floor (front)	L209	1618 (63.7)
Cargo length at second seatback height	L210	824 (32.4)
Cargo length at floor (second)	L211	908 (35.7)
Front seatback to load floor height	H187	341 (13.4)
Second seatback to load floor height	H188	211 (8.3)
Cargo volume index m <sup>3</sup> (ft. <sup>3</sup> )	V3	930 L. (32.8 cu. ft.)
Hidden cargo volume index m <sup>3</sup> (ft. <sup>3</sup> )	V4	—
Cargo volume index - rear of 2-seat	V11	366 L. (12.9 cu. ft.)

All linear dimensions are in millimeters (inches) unless otherwise noted.

\* MPV - Multipurpose Vehicle

\*\* EPA Loaded Vehicle Weight, Loading Conditions

# MVMA Specifications

Vehicle Line CAMARO  
 Model Year 1997 Issued \_\_\_\_\_ Revised (\*) \_\_\_\_\_

## METRIC (U.S. Customary)

Model Code/  
Description

ALL

### Vehicle Fiducial Marks

Fiducial Mark Number*	Define Coordinate Location
Front	<p>X - Fiducial mark to vertical zero grid line - front measured horizontally, from the zero grid line to the front fiducial mark located on top of the front seat adjuster mounting bolt.</p> <p>Y - Fiducial mark to centerline of car - front, width measurement made from centerline car to fiducial mark located on top of the front seat adjuster mounting bolt.</p> <p>Z - Fiducial mark to horizontal zero grid line - front, measured vertically from zero grid line to front fiducial mark located on top of the front seat adjuster mounting bolt.</p>
Rear	<p>X - Fiducial mark to vertical zero grid line - rear, measured horizontally from the zero grid line to rear fiducial mark located on the rail (compartment pan - longitudinal.)</p> <p>Y - Fiducial mark to centerline of car - rear, width measurement made from centerline of car to fiducial mark located on the rail (compartment pan - longitudinal.)</p> <p>Z - Fiducial mark to horizontal zero grid line - rear, measured vertically from the zero grid line to rear fiducial mark located on the rail (compartment pan - longitudinal.)</p>
NOTE: Provide 3 of 4 Fiducial Mark Locations	
Front	W21*** 540 (21.3)
	L54*** 2688 (105.8)*
	H81*** 468 (18.4)#
	H161*** 292 (11.5)
	H163*** 279 (11.0)
Rear	W22*** 548 (21.6)
	L55*** 4815 (189.6)*
	H82*** 597 (23.5)#
	H162*** 435 (17.1)
	H164*** 412 (16.2)
	* Vertical Base Grid 2000 mm Line # Horizontal Base Grid 500 mm Line

\* Reference - SAE Recommended Practice, J182a, Motor Vehicle Fiducial Marks.

\*\* Reference - SAE Recommended Practice J1100 - Motor Vehicle Dimensions.

\*\*\* EPA Loaded Vehicle Weight, Loading Conditions

All linear dimensions are in millimeters (inches) unless otherwise noted.



**MVMA Specifications**  
**METRIC (U.S. Customary)**

Vehicle Line CAMARO  
 Model Year 1997 Issued \_\_\_\_\_ Revised (●) \_\_\_\_\_

Code	Equipment	Optional Equipment Differential Mass (weight)*			Remarks Restrictions, Requirements
		MASS, kg. (lb.)			
		Front	Rear	Total	
AG1	Power Seat - 6-Way (Driver's Seat Only)	1.0 (2.2)	1.0 (2.2)	2.0 (4.4)	
AN4	Child Restraint Provision	0.0 (0.0)	0.4 (0.8)	0.4 (0.8)	
AU3	Power Door Locks - Electric	0.4 (0.8)	0.4 (0.8)	0.8 (1.6)	
A31	Power Windows - Electric	1.2 (2.6)	0.6 (1.3)	1.8 (3.9)	
B35	Rear Floor Mats	0.0 (0.0)	0.6 (1.3)	0.6 (1.3)	
B84	Moldings - Body Side	0.4 (0.9)	0.4 (0.9)	0.8 (1.8)	
CC1	Roof - Removable Hatch Panels - Glass	2.8 (6.1)	2.8 (6.1)	5.6 (12.3)	
C49	Defogger - Rear Window (Electric)	0.0 (0.0)	0.2 (0.4)	0.2 (0.4)	
C60	Air Conditioning (Manual Control)	18.0 (39.7)	1.2 (2.6)	19.2 (42.3)	&L36
C60	Air Conditioning (Manual Control)	14.2 (32.1)	2.4 (5.2)	17.0 (37.4)	
DE4	Sunshades - Removeable for Hatch Roof	0.2 (0.4)	0.4 (1.8)	0.6 (1.3)	
DD9	Mirror - Chrome Electric	0.6 (1.3)	0.2 (0.4)	0.8 (1.8)	
DG7	Sport Mirrors - Electric, Remote Control RH & LH Controls on LH Door Panel	0.6 (1.3)	0.0 (0.0)	0.6 (1.3)	
FE2	Suspension System Ride & Handling	0.6 (1.3)	0.4 (1.8)	1.0 (2.2)	
GU4	Rear Axle 3.08 Ratio	0.0 90.0)	0.6 (1.3)	0.6 (1.3)	
GU5	Rear Axle 3.23 Ratio	0.0 (0.0)	-6.2 (-13.6)	-6.2 (-13.6)	

\* Also see Engine - General Section for dressed engine mass (weight.)



**MVMA Specifications**  
**METRIC (U.S. Customary)**

Vehicle Line CAMARO  
 Model Year 1997 Issued \_\_\_\_\_ Revised (\*) \_\_\_\_\_

Code	Equipment	Optional Equipment Differential Mass (weight)*			Remarks - - Restrictions, Requirements
		MASS, kg. (lb.)			
		Front	Rear	Total	
IP2	Leather Interior Trim	1.0 (2.2)	1.0 (2.2)	2.0 (4.4)	
J65	Brake System - Power	4.8 (10.5)	2.0 (4.4)	6.8 (14.9)	
KG9	Generator - 140 Amp	1.4 (3.0)	0.0 (0.0)	1.4 (3.0)	
K05	Heater - Engine Block	0.4 (0.8)	0.0 (0.0)	0.4 (0.8)	
K34	Cruise Control - Three Mode with Resume Feature	2.0 (4.4)	0.6 (1.3)	2.6 (5.7)	
LT1	5.7 Liter V8 (350 CID)	32.8 (72.3)	4.0 (8.8)	36.8 (81.1)	
M30	Automatic Transmission (Overdrive)	13.7 (30.2)	4.5 (9.9)	18.2 (40.1)	&LT1
M30	Automatic Transmission (Overdrive)	15.2 (33.5)	5.2 (11.4)	20.4 (44.9)	L36
MM6	Six-Speed Manual Transmission	9.8 (21.6)	3.0 (6.6)	12.8 (28.2)	
NP5	Leather Wrapped Steering Wheel, Shift Knob & Brake Release Handle	0.2 (0.4)	0.0 (0.0)	0.2 (0.4)	
NW9	ASR-Acceleration Slip Regulation	0.8 (1.8)	6.4 (14.1)	7.2 (15.8)	
QCB	Tires - P235/55R16 BW	1.8 (3.9)	2.0 (4.4)	3.8 (8.3)	
QFZ	Tires - P245/50ZR16 Traction Tires	2.6 (5.7)	2.6 (5.7)	5.2 (11.4)	
QLC	Tires - P245/50ZR16	2.8 (6.1)	2.8 (6.1)	5.6 (12.3)	
T2H	Ornamentation - Extr - Export	0.2 (0.4)	0.0 (0.0)	0.2 (0.4)	
T96	Fog Lamps	2.2 (4.8)	-0.4 (-0.8)	1.8 (3.9)	

\* Also see Engine - General Section for dressed engine mass (weight.)

**MVMA Specifications  
METRIC (U.S. Customary)**

Vehicle Line CAMARO  
Model Year 1997 Issued \_\_\_\_\_ Revised (●) \_\_\_\_\_

Code	Equipment	Optional Equipment Differential Mass (weight)*			Remarks Restrictions, Requirements
		MASS, kg. (lb.)			
		Front	Rear	Total	
UD4	Vehicle Speed Alarm	0.2 (0.4)	0.0 (0.0)	0.2 (0.4)	
UN0	AM/FM Radio, Cassette	0.4 (1.7)	0.0 (0.0)	0.4 (1.7)	
UZ7	Speaker System - Eight Quad Frt. Amp	2.0 (4.4)	2.0 (4.4)	4.0 (8.8)	
U75	Antenna - power	1.0 (2.2)	0.2 (0.4)	1.2 (2.6)	
VK3	License Plate Frt. Mount Package	0.2 (0.4)	0.0 (0.0)	0.2 (0.4)	
VR6	Hook Tie Down	0.0 (0.0)	1.0 (2.2)	1.0 (2.2)	
Y3F	Sales Package - RS	3.8 (8.3)	6.0 (13.2)	9.8 (21.6)	
Y87	Merch. Package - Performance	1.0 (2.2)	1.4 (3.0)	2.4 (5.2)	
1LE	Performance Package Components	1.0 (2.2)	0.6 (1.3)	1.6 (3.5)	

\* Also see Engine - General Section for dressed engine mass (weight.)

Specifications  
METRIC

Exterior Vehicle And Body Dimensions - Key Sheet

Exterior Width Dimensions

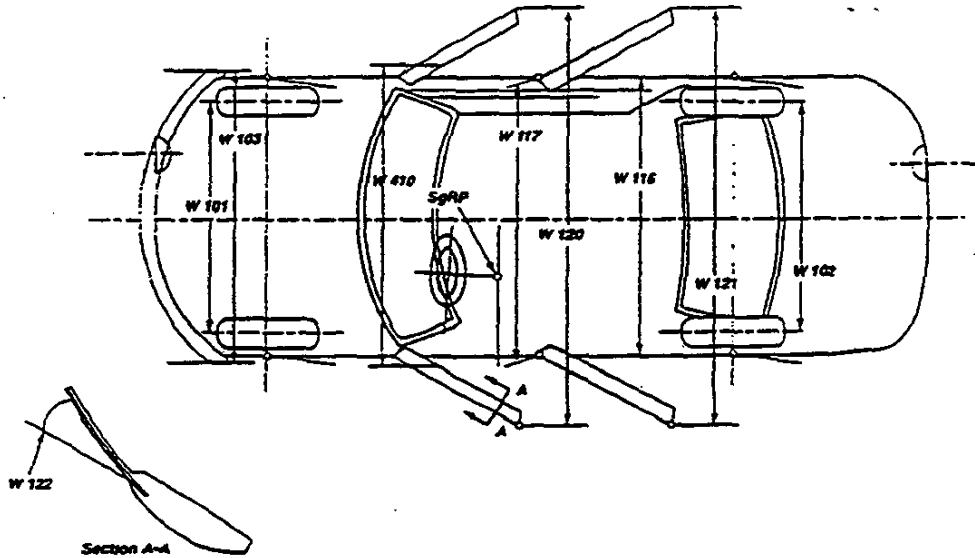

Exterior Length & Height Dimensions

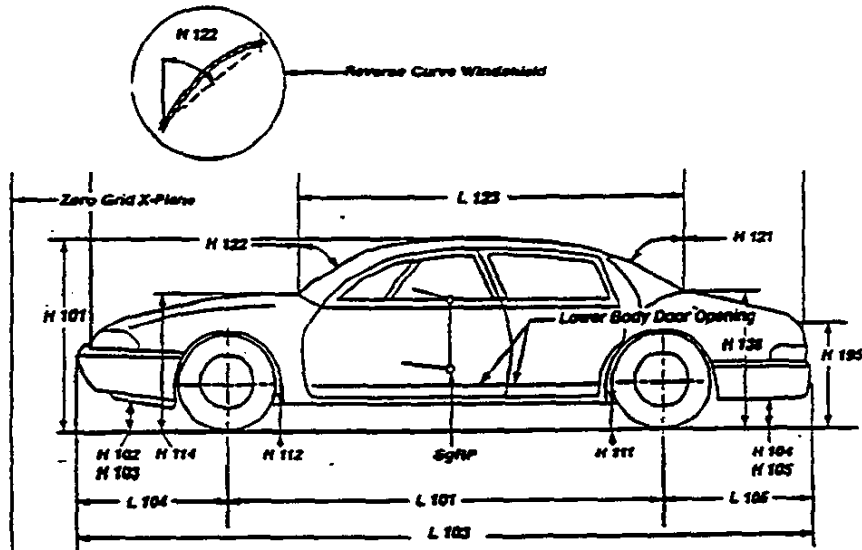

Ground Clearance Dimensions

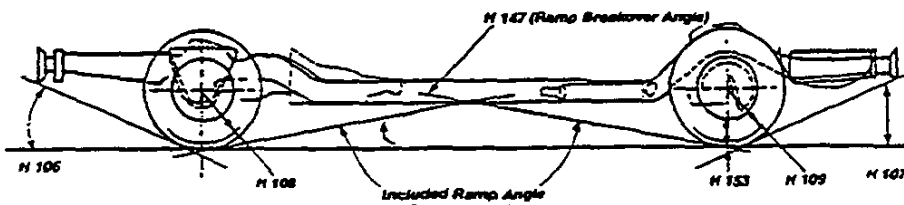

# Specifications

## METRIC

### Interior Vehicle And Body Dimensions - Key Sheet

Interior Length Dimensions

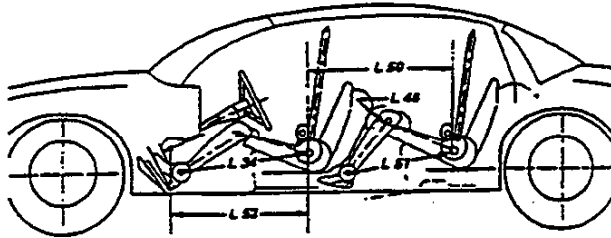

Interior Height Dimensions

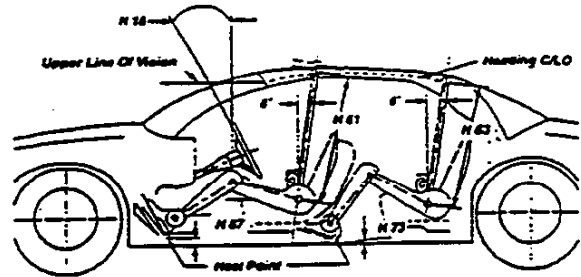

Interior Height Dimensions

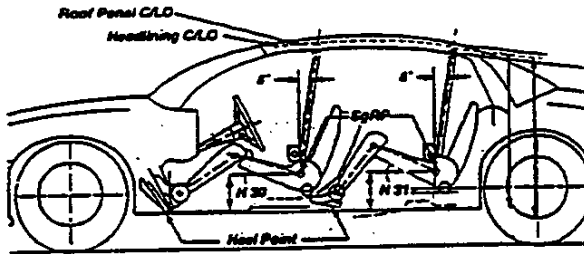

Interior Length Dimensions

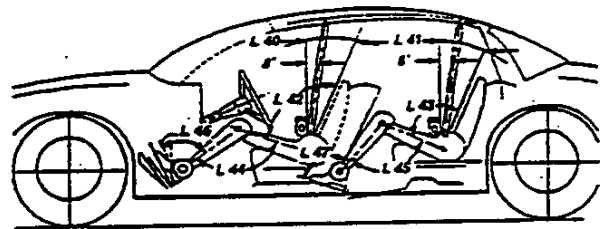

Interior Width Dimensions

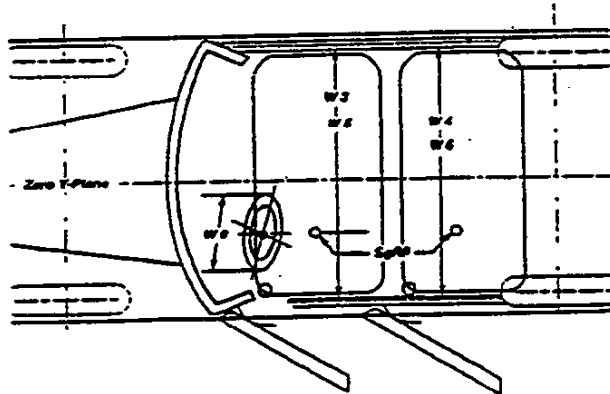

Interior Height Dimensions

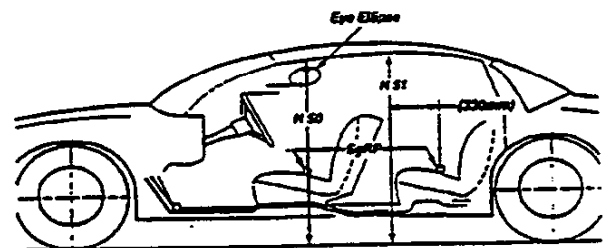

# Specifications METRIC

## Interior Vehicle And Body Dimensions - Key Sheet

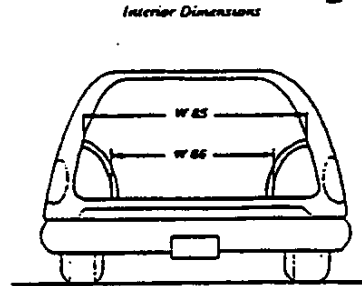
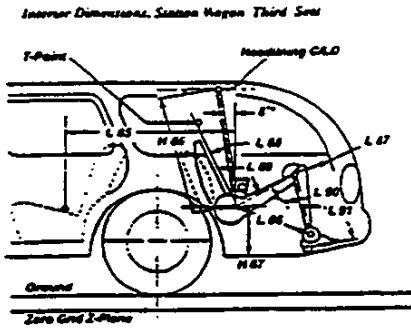

*Cargo Space Dimensions*

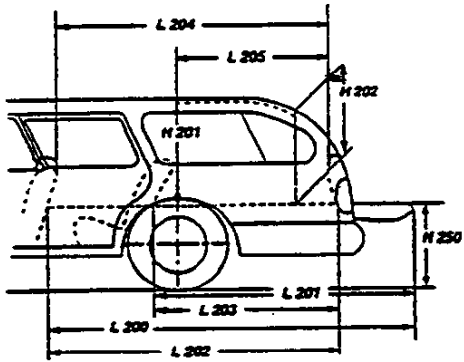

*Cargo Space Dimensions*

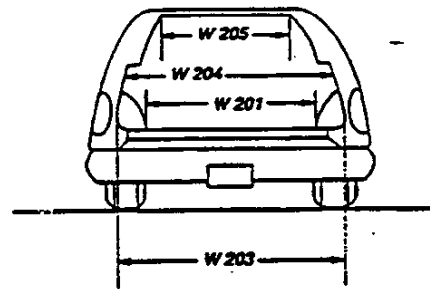

*Cargo Space Dimensions*

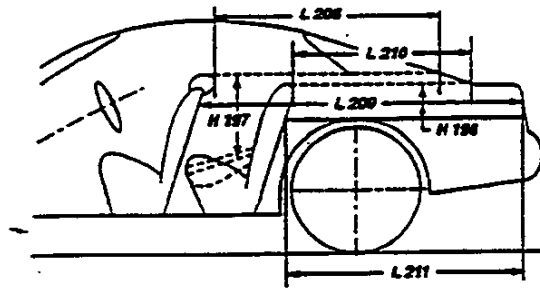

*Multipurpose Vehicle Cargo Space*

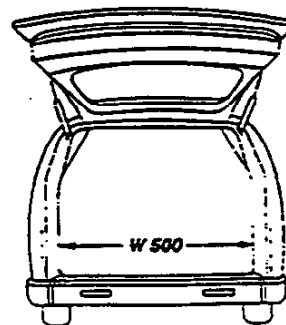
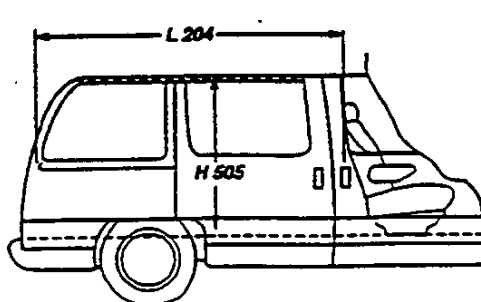

# Specifications METRIC

## Exterior Vehicle And Body Dimensions - Key Sheet Dimensions Definitions

### Seating Reference Point

SEATING REFERENCE POINT means the manufacturer's design reference point which -  
(a) Establishes the rearmost normal design driving or riding position of each designated seating position in a vehicle;  
(b) Has coordinates established relative to the design vehicle structure;  
(c) Simulates the position of the pivot center of the human torso and thigh; and  
(d) is the reference point employed to position the two dimensional templates described in SAE Recommended Practice J826, "Devices for Use in Defining and Measuring Vehicle Seating Accommodations."

### Width Dimensions

- W101 TREAD-FRONT. The dimension measured between the tire centerlines at the ground.
- W102 TREAD-REAR. The dimension measured between the tire centerlines at the ground. In case of dual wheels, the dimension will be measured to the centerline of tire and wheel assemblies.
- W103 VEHICLE WIDTH. The maximum dimension measured between the widest point on the vehicle, excluding exterior mirrors, flexible mud flaps, marker lamps, but including bumpers, moldings, sheet metal protrusions or dual wheels, if standard equipment.
- W117 BODY WIDTH AT SgRP-FRONT. The dimension measured laterally between the widest points on the body at the SGRP-front, excluding door handles, applied moldings, or appliques.
- W120 VEHICLE WIDTH-FRONT DOORS OPEN. The dimension measured between the widest point on the rear doors in maximum hold-open position.
- W121 VEHICLE WIDTH-REAR DOORS OPEN. The dimension measured between the widest point on the rear doors in maximum hold-open position. For vehicles with a rear door on only one side, this dimension is to the zero "Y" plane.
- W122 TUMBLE-HOME, STRAIGHT SIDE GLASS. The angle measured from a vertical to the outside surface of the front door glass at the SgRP "X" plane.  
CURVED SIDE GLASS. The angle measured from a vertical to a chord extending from the upper DLO to the lower DLO at the outside surface of the front door glass at the front SgRP "X" plane.
- W410 OUTSIDE MIRROR WIDTH: The dimension between the widest point on the outside mirrors. The standard right and left mirror adjusted for normal driving will be shown unless otherwise noted. When only one outside mirror is standard, the dimension will be to the zero "Y" plane.

### Length Dimensions

- L101 WHEELBASE (WB). The dimension measured longitudinally between front and rear wheel centerline. In case of dual rear axles, the dimension shall be to the midpoint of the centerlines of the rear wheels.
- L103 VEHICLE LENGTH. The maximum dimension measured longitudinally between the foremost point and the rearmost point on the vehicle, including bumper, bumper guards, tow hooks and/or rub strips, if standard equipment.
- L104 OVERHANG-FRONT. The dimension measured longitudinally from the centerline of the front wheels to the foremost point on the vehicle including bumper, bumper guards, tow hook and/or rub strips, if standard equipment.
- L105 OVERHANG-REAR. The dimension measured longitudinally from the centerline of the rear wheels; or in the case of dual rear axles, the dimension shall be the midpoint of the centerlines of the rear wheels, to the rearmost point on the vehicle including rear bumpers, bumper guards, tow hooks and rub strips, if standard equipment.

- L123 UPPER STRUCTURE LENGTH. The dimension measured longitudinally from the cowl point to the deck point.
- L127 REAR WHEEL CENTERLINE "x" COORDINATE or in the case of dual rear axles, the coordinate shall be the midpoint of the distance between the rear axle centerlines.

### Height Dimensions

- H101 VEHICLE HEIGHT. The dimension measured vertically from the highest point on the vehicle body to ground.
- H111 ROCKER PANEL-REAR TO GROUND. The dimension measured vertically from the bottom of the rocker or side quarter panel at the front of the rear wheel opening, excluding flanges, to ground.
- H112 ROCKER PANEL-FRONT TO GROUND. The dimension measured vertically from the foremost point on the bottom of the rocker panels, excluding flanges, to ground.
- H114 COWL POINT TO GROUND. Measured at zero "Y" plane.
- H121 BACKLIGHT SLOPE ANGLE. The angle between the vertical reference line and the surface of backlight at vehicle zero "Y" plane. For curve backlight, the angle is to chord of backlight arc from lower DLO to upper DLO.
- H122 WINDSHIELD SLOPE ANGLE. The angle between the vertical reference line and a chord of the windshield arc running from the lower DLO to the upper DLO at the vehicle zero "Y" plane. In the case of wrap over glass, the angle to be measured will be formed by a chord 457 mm (18.0 in.) long drawn from the lower DLO to the intersecting point on the windshield.
- H138 DECK POINT TO GROUND. Measured at zero "Y" plane.
- H109 STATICLOAD-TIRE RADIUS-REAR. Specified by the manufacturer in accordance with composite TIRE SECTION STANDARD.

### Ground Clearance Dimensions

- H102 FRONT BUMPER TO GROUND. The minimum dimension measured vertically from the lowest point on the front bumper to ground, including bumper guards, if standard equipment.
- H103 FRONT BUMPER TO GROUND-CURBMASS(WT.). Measured in the same manner as H102.
- H104 REAR BUMPER TO GROUND. The minimum dimension measured vertically from the lowest point on the rear bumper to ground, including bumper guards, if standard equipment.
- H105 REAR BUMPER TO GROUND-CURB MASS(WT.). Measured in the same manner as H104.
- H106 ANGLE OF APPROACH. The angle measured between a line tangent to the front tire static loaded radius arc and the initial point of structural interference forward of the front tire to ground. The limiting structural component shall be designated.
- H107 ANGLE OF DEPARTURE. The angle measured between a line tangent to the rear tire static loaded radius arc and the initial point of structural interference rearward of the rear tire to ground. The limiting component shall be designated.
- H147 RAMP BREAKOVER ANGLE. The angle measured between two lines tangent to the front and rear tire static loaded radius and intersecting at a point on the underside of the vehicle which defines the largest ramp over which the vehicle can roll.
- H153 REAR AXLE DIFFERENTIAL TO GROUND. The minimum dimension measured from the rear axle differential to ground.
- H156 MINIMUM RUNNING GROUND CLEARANCE. The minimum dimension measured from the sprung vehicle to ground. Specify location.

# Specifications

## METRIC

### Interior Vehicle And Body Dimensions - Key Sheet

#### Dimensions Definitions

#### Glass Areas

- S1 Windshield area.  
 S2 Side windows area. Includes the front door, rear door, vents, and rear quarter windows on both sides of the vehicle.  
 S3 Backlight areas.  
 S4 Total area. Total of all areas (S1 + S2 + S3).

#### Fiducial Mark Dimensions

- Fiducial Mark - Number 1  
 L54 "X" coordinate.  
 W21 "Y" coordinate.  
 H81 "Z" coordinate.  
 H161 Height "Z" coordinate to ground at curb weight.  
 H163 Height "Z" coordinate to ground.  
 Fiducial Mark - Number 2  
 L55 "X" coordinate.  
 W22 "Y" coordinate.  
 H82 "Z" coordinate.  
 H162 Height "Z" coordinate to ground at curb weight.  
 H164 Height "Z" coordinate to ground.

#### Front Compartment Dimensions

- L11 ACCELERATOR WHEEL POINT TO STEERING WHEEL CENTER. The dimension measured horizontally from the AHP to the intersection of the steering column centerline and a plane tangent to the upper surface of the steering wheel rim.  
 L17 DESIGN-H-POINT-FRONT TRAVEL. The dimension measured horizontally between the design H-point-front in the foremost and rearmost seat track positions. (See SAE J1100)  
 L23 NORMAL DRIVING AND RIDING SEAT TRACK TRAVEL. The dimension measured horizontally between a point on the design H-point travel line from the SgRP to the displaced point on the design H-point travel line with the seat moved to the foremost seat position, but not to include seat track travel used for purposes other than normal driving and riding positions. (See SAE J1100).  
 L31 SgRP-Front. "X" Coordinated.  
 L34 MAXIMUM EFFECTIVE LEG ROOM-ACCELERATOR. The dimension measured along a line from the ankle pivot center to the SgRP-front plus 254 mm (10.0 in.) measured with right foot on the underdepressed accelerator pedal. For vehicles with SgRP to heel (H30) greater than 18 in., the accelerator pedal may be depressed as specified by the manufacturer. If the accelerator is depressed, the manufacturer shall place foot flat on pedal and note the depression of the pedal.  
 L40 BACK ANGLE-FRONT. The angle measured between a vertical line through the SgRP-front and the torso line. If the seatback is adjustable, use the normal driving and riding position specified by the manufacturer.  
 L42 HIP ANGLE-FRONT. The angle measured between torso line and thigh centerline.  
 L44 KNEE ANGLE-FRONT. The angle measured between thigh centerline and lower leg centerline measured on the right leg.  
 L46 FOOT ANGLE-FRONT. The angle measured between the lower leg centerline and a line tangent to the ball and heel of the bare foot flesh line measured on the right leg. Ref SAE J826.  
 L53 SgRP-FRONT TO HEEL. The dimension measured horizontally from the SgRP-front to the accelerator heel point.  
 W3 SHOULDER ROOM-FRONT. The minimum dimension measured laterally between the trimmed surfaces on the "X" plane through the SgRP-front at height between the belt line and 254 mm (10.0 in.) above the SgRP-front, excluding the door assist strap and attaching parts.

- W5 HIP ROOM-FRONT. The minimum dimension measured laterally between the trimmed surfaces on the "X" plane through the SgRP-front within 25 mm (1.0 in.) below and 76 mm (3.0 in.) above the SgRP-front and 76 mm (3.0 in.) fore and aft of the SgRP-front.  
 W9 STEERING WHEEL MAXIMUM OUTSIDE DIAMETER. Define if other than round.  
 H7 ACCELERATOR HEEL POINT TO THE STEERING WHEEL CENTER. The dimension measured vertically from the AHP-front to the intersection of the steering column centerline to a plane tangent to the upper surface of the steering wheel rim.  
 H18 STEERING WHEEL ANGLE. The angle measured from a vertical to the surface plane of the steering wheel.  
 H30 SgRP-FRONT TO HEEL. The dimension measured vertically from the SgRP-front to the accelerator heel point.  
 H50 UPPER BODY OPENING TO GROUND-FRONT. The dimension measured vertically from the trimmed body opening to the ground on the SgRP-front "X" plane.  
 H61 EFFECTIVE HEAD ROOM-FRONT. The dimension measured along a line 8 deg. rear of vertical from the SgRP-front to the headlining plus 102 mm (4.0 in.).  
 H67 FLOOR COVERING THICKNESS - UNDEPRESSED - FRONT. The dimension measured vertically from the surface of the underdepressed floor covering to the underbody sheet metal at the accelerator heel point.

#### Rear Compartment Dimensions

- L41 BACK ANGLE-SECOND. The angle measured between a vertical line through the SgRP-second and the torso line.  
 L43 HIP ANGLE-SECOND. The angle measured between torso line and thigh centerline.  
 L45 KNEE ANGLE-SECOND. The angle measured between thigh centerline and lower leg centerline.  
 L47 FOOT ANGLE-SECOND. The angle measured between the lower leg centerline and a line tangent to the ball and heel of the three-dimensional devices bare foot flesh line (Reference J826).  
 L48 KNEE CLEARANCE-SECOND. The minimum dimension measured from the knee pivot center to the back of the front seatback minus 51 mm (2.0 in.).  
 L50 SgRP COUPLE DISTANCE-SECOND. The dimension measured horizontally from the driver SgRP-front to the SgRP-second.  
 L51 MINIMUM EFFECTIVE LEG ROOM-SECOND. The dimension measured along a line from the ankle pivot center to the SgRP-second plus 254 mm (10.0 in.).  
 W4 SHOULDER ROOM-SECOND. The minimum dimension measured laterally between door or quarter trimmed surfaces on the "X" plane through the SgRP-second at height between 254-406 mm (10.0-16.0 in.) above the SgRP-second, excluding the door assist straps and attaching parts.  
 W6 HIP ROOM-SECOND. Measured in the same manner as W5.  
 H31 SgRP-SECOND TO HEEL. The dimension measured vertically from the SgRP-second to the two dimensional device heel point on the depressed floor covering.  
 H51 UPPER BODY OPENING TO GROUND-SECOND. The dimension measured vertically from the trimmed body opening to the ground on the "X" plane 330 mm (13.0 in.) forward of the SgRP-second.  
 H63 EFFECTIVE HEAD ROOM-SECOND. The dimension measured along a line 8 deg. rear of vertical from the SgRP to the headlining, plus 102 mm (4.0 in.).  
 H73 FLOOR COVERING-DEPRESSED-SECOND. The dimension measured vertically from the heel point to the underbody sheet metal.

# Specifications

## METRIC

### Interior Vehicle And Body Dimensions - Key Sheet

#### Dimensions Definitions

#### Luggage Compartment Dimensions

V1 **USABLE LUGGAGE CAPACITY**-Total of volumes of individual pieces of standard luggage set plus H-boxes stowed in the luggage compartment in accordance with the procedure described in paragraph 8.2 of SAE-J1100a.

#### Interior Volumes (EPA Classification)

The Interior Index is listed for each body style except two seaters. The Interior Volume Index estimates the space in a car. It is based on four measurements - head room, shoulder room, hip room, and leg room - for the front and rear seats, plus trunk capacity.

The Trunk/Cargo Index is an estimate of the size of the trunk/cargo space. In station wagons and hatchbacks it is an estimate of the space behind the second seat.

#### Station Wagon/MPV - Third Seat Dimensions

- L85 **SgRP COUPLE DISTANCE-THIRD**. The dimension measured horizontally from the SgRP-second to the SgRP-third.
- L86 **EFFECTIVE LEG ROOM-THIRD**. The dimension measured along a line from the ankle pivot center to the SgRP-third plus 254 mm (10.0 in.).
- L87 **KNEE CLEARANCE-THIRD**. The minimum dimension from the knee pivot center to the back of second seatback minus a constant of 51 mm (2.0in.). With rear-facing third seat, dimension is measured to closure.
- L88 **BACK ANGLE-THIRD**. Measured in the same manner as L41.
- L89 **HIP ANGLE-THIRD**. Measured in the same manner as L43.
- L90 **KNEE ANGLE-THIRD**. Measured in the same manner as L45.
- L91 **FOOT ANGLE-THIRD**. Measured in the same manner as L47.
- W85 **SHOULDER ROOM-THIRD**. Measured in the same manner as W4.
- W86 **HIP ROOM-THIRD**. Measured in the same manner as W5.
- H86 **EFFECTIVE HEAD ROOM-THIRD**. The dimension, measured along a line 8 deg. from the SgRP-third to the headlining rear of vertical plus a constant of 102 mm (4.0 in.).
- H87 **SgRP-THIRD TO HEEL POINT**
- SD1 **SEAT FACING DIRECTION-THIRD**.

#### Station Wagon/MPV - Cargo Space Dimensions

- L200 **CARGO LENGTH-OPEN-FRONT**. The minimum dimension measured longitudinally from the back of the front seatback at the height of the undepressed floor covering to the rearmost point on the undepressed floor covering on the open tailgate or cargo surface if the rear closure is a conventional door type tailgate at the zero "Y" plane.
- L201 **CARGO LENGTH-OPEN-SECOND**. The dimension measured longitudinally from the back of the second seatback at the height of the undepressed floor covering on the open tailgate or cargo floor surface if the rear closure is a conventional door type tailgate, at the zero "Y" plane.

- L202 **CARGO LENGTH-CLOSED-FRONT**. The minimum dimension measured horizontally from the back of the front seat at the height of the undepressed floor covering to the rearmost point on the undepressed floor covering on the closed tailgate or taildoor for station wagons, trucks and mpv's at the zero "Y" plane.
- L203 **CARGO LENGTH-CLOSED-SECOND**. The dimension measured horizontally from the back of the second seat at the height of the undepressed floor covering to the rearmost point on the undepressed floor covering on the closed tailgate or taildoor for station wagons, trucks and mpv's at the zero "Y" plane.
- L204 **CARGO LENGTH AT BELT-FRONT**. The minimum dimension measured horizontally from the back of the front seatback at the seatback top to the foremost normal surface of the closed tailgate or inside surface of the cab backpanel at the height of the belt, on the zero "Y" plane.
- L205 **CARGO LENGTH AT BELT-SECOND**. The minimum dimension measured horizontally from the back of the second seatback top to the foremost normal surface of the closed tailgate at the height of the belt, on the zero "Y" plane.
- W201 **CARGO WIDTH-WHEELHOUSE**. The minimum dimension measured laterally between the trimmed wheelhouses at floor level. For any vehicle not trimmed, measure to the sheet metal.
- W203 **REAR OPENING WIDTH AT FLOOR**. The minimum dimension measured laterally between the limiting interferences of the rear opening at floor level.
- W204 **REAR OPENING WIDTH AT BELT**. The minimum dimension measured laterally between the limiting interferences of the rear opening at belt height or top of pick up box.
- W205 **REAR OPENING WIDTH ABOVE BELT**. The minimum dimension measured laterally between the limiting interferences of the rear opening above the belt height.
- W500 **CARGO WIDTH AT FLOOR**. The maximum dimension measured laterally between the limiting interferences at the floor level. This dimension shall include ribs and pillars, but will exclude wheelhouses.
- H197 **FRONT SEATBACK TO LOAD FLOOR HEIGHT**. The dimension measured vertically from the horizontal tangent to the top of the seatback to the undepressed floor covering.
- H201 **CARGO HEIGHT**. The dimension measured vertically from the top of the undepressed floor covering to the headlining at the rear wheel "X" coordinate on the zero "Y" plane.
- H202 **REAR OPENING HEIGHT**. The dimension measured vertically from the top of the undepressed floor covering to the upper trimmed opening on the zero "Y" plane with rear door fully open.
- H250 **TAILGATE TO GROUND CURB MASS (WT.)** The dimension measured vertically from the top of the undepressed floor covering on the lowered tailgate to ground on the zero "Y" plane.
- H505 **MAXIMUM CARGO HEIGHT**. The maximum vertical dimension rear of the front seat from the cargo floor to roof bow or headlining at the zero "Y" plane.



# Specifications

## METRIC

### Interior Vehicle And Body Dimensions - Key Sheet

#### Dimensions Definitions

<p>V2 STATION WAGON Measured in inches:</p> $\frac{W4 \times H201 \times L204}{1728} - ft^3$ <p>Measured in mm:</p> $\frac{W4 \times H201 \times L204}{10^9} - m^3(cubicmeter)$	<p>L208 CARGO LENGTH AT FRONT SEATBACK HEIGHT. The minimum horizontal dimension from the "X" plane tangent to the rearmost surface of the driver's seatback to the inside limiting interference of the hatchback door on the vehicle zero "Y" plane.</p> <p>L209 CARGO LENGTH AT FLOOR-FRONT. The minimum horizontal dimension measured at floor level from the rear of the front seatback to the normal limiting interference of the hatchback door on the vehicle zero "Y" plane.</p> <p>L210 CARGO LENGTH AT SECOND SEATBACK HEIGHT. The minimum dimension measured from the "X" plane tangent to the rearmost surface of second seatback or the load floor which is towed at least one half of the H198 dimension height above the rear load floor, to the rearmost inside limiting interference on the zero "X" plane.</p>
<p>V4 HIDDEN LUGGAGE CAPACITY-REAR OF FRONT SEAT. The total volumes of individual pieces of one set of standard luggage stowed in any hidden cargo area below the load floor rear of the front seat.</p>	<p>L211 CARGO LENGTH AT FLOOR-SECOND SEATBACK. The minimum horizontal dimension measured at floor level from the rear of the second seatback or load floor panel to the normal limiting interference of the hatchback door on the vehicle zero "Y" plane.</p>
<p>V5 TRUCKS AND MPV'S WITH OPEN AREA. Measured in inches:</p> $\frac{L506 \times W505 \times H503}{1728} - ft^3$ <p>Measured in mm:</p> $\frac{L506 \times W500 \times H503}{10^9} - m^3(cubicmeter)$	<p>H197 FRONT SEATBACK TO LOAD HEIGHT. The dimension measured vertically from the horizontal tangent to the top of the seatback to the undepressed floor covering.</p> <p>H198 SECOND SEATBACK TO LOAD FLOOR HEIGHT. The dimension measured vertically from the second seatback to the undepressed floor covering.</p>
<p>V6 TRUCKS AND MPV'S WITH CLOSED AREA. Measured in inches:</p> $\frac{L204 \times W500 \times H505}{1728} - ft^3$ <p>Measured in mm:</p> $\frac{L204 \times W500 \times H505}{10^9} - m^3(cubicmeter)$	<p>V3 HATCHBACK. Measured in inches:</p> $\frac{L208 - L209}{2} \times W4 \times H197 - ft^3$ <p>Measured in mm:</p> $\frac{L208 - L209}{2} \times W4 \times H197 - m^3(cubicmeter)$
<p>V8 HIDDEN LUGGAGE CAPACITY-REAR OF SECOND SEAT. The total volume of individual pieces of one set of standard luggage stowed in any hidden cargo area below the load floor rear of the second seat.</p>	<p>V4 HIDDEN LUGGAGE CAPACITY-REAR OF FRONT SEAT. The total volumes of individual pieces of one set of standard luggage stowed in any hidden cargo area below the load floor rear of the front seat.</p>
<p>V10 STATION WAGON CARGO VOLUME INDEX. Measured in inches:</p> $\frac{H201 \times L205 \times \frac{W4 - W201}{2}}{1728} - ft^3$ <p>Measured in mm:</p> $\frac{H201 \times L205 \times \frac{W4 - W201}{2}}{10^9} - m^3(cubicmeter)$	<p>V11 HATCHBACK CARGO VOLUME INDEX. Usable luggage (one (1) stand and luggage set) below floor: Measured in inches:</p> $\frac{L210 - L211}{2} \times W4 \times H198 - ft^3$ <p>Measured in mm:</p> $\frac{L210 - L211}{2} \times W4 \times H198 - m^3(cubicmeter)$

#### Hatchback - Cargo Space Dimensions

All Hatchback cargo dimensions are to be taken with the front seat in full down and rear position, and the rear seat folded down. The hatchback door is in the closed position. (For electronically adjusted seats, see the manufacturer's specifications for Design "H" Point).

# Specifications

## METRIC

### Index

Subject	Page No.	Subject	Page No.
Alternator	16	Origin	1
Axle, Drive, Front, Rear, All Four	2, 9, 10	Passenger Capacity	1
Axle Shafts	10	Passenger Mass Distribution	26
Battery	16	Pistons	3
Body and Miscellaneous Information	17	Power Brakes	12
Brakes-Parking Service	12, 13	Power Engine	2
Camber	15	Power Steering	14
Camshaft	3	Power Teams	2
Capacities		Propeller Shaft	10
Cooling System	5	Pumps-Fuel	6
Fuel Tank	6	Water	5
Lubricants		Radiator-Cap, Hoses, Core	5
Engine Crankcase	4	Ratios-Axle, Transaxle	2,9,10
Transmission/Transaxle	8,9	Compression	2
Rear Axle	10	Steering	14
Carburetor	2,6	Transmission/Transaxle	2,8,9
Caster	15	Rear Axle	2,10
Climate Control System	19	Regulator-Alternator	16
Clutch-Pedal Operated	8	Restraint System	18
Coil, Ignition	16	Rims	13
Connecting Rods	4	Rods-Connecting	4
Convenience Equipment	20-21	Scrub Radius	14
Cooling System	5	Seats	17
Crankshaft	4	Shock Absorbers, Front & Rear	11
Cylinders and Cylinder Head	3	Spark Plugs	16
Diesel Information	4	Speedometer	15
Dimension Definitions		Springs-Front & Rear Suspension	11
Key Sheet-Exterior	28,31,32	Stabilizer (Sway Bar)-Front & Rear	11
Key Sheet-Interior	29,30,32,33,34	Starting System	16
Electrical System	15,16	Steering	14
Emission Controls	7	Suppression-Ignition, Radio	16
Engine-General		Suspension-Front & Rear	11
Bore, Stroke, Type	3	Tail Pipe	7
Compression Ratio	2	Theft Protection	21
Displacement	2,3	Thermostat, Cooling	5
Firing Order, Cylinder Numbering	3	Tires	13
General Information, Power & Torque	2	Toe-In	15
Intake System	4	Torque Converter	9
Power Teams	2	Torque-Engine	2,8,9
Exhaust System	7	Trailer Towing	21
Equipment Availability, Convenience	20	Transaxle	9
Fan, Cooling	5	Transmission-Types	2,8,9
Filters - Engine Oil, Fuel System	4	Transmission-Automatic	2,9
Four Wheel Drive	10	Transmission-Manual	2,8
Frame	17	Transmission-Ratios	2,8,9
Front Suspension	11	Tread	22
Front Wheel Drive Unit	10	Trunk Cargo Load	1
Fuel Economy, EPA	1	Trunk Luggage capacity	23
Fuel Injection	6	Turning Diameter	14
Fuel System	6	Unitized Construction	18
Fuel Tank	6	Universal Joints, Propeller Shaft	10
Glass	18	Valve System	4
Headlamps	18	Vehicle Dimensions	
Headroom-Body	23,24	Width	22
Heights	22	Length	22
Horns	15	Height	22
Horsepower-Brake	2	Ground Clearance	22
Ignition System	16	Front Compartment	23
Inflation-Tires	13	Rear Compartment	23
Interior Volumes	23	Luggage Compartment	23
Instruments	15	Station Wagon-Third Seat	24
Legroom	23,24	Station Wagon-Cargo Space	24
Lengths	22	Hatchback-Cargo Space	24
Leveling,Suspension	11	Fiducial Marks	25
Lifters, Valve	4	Voltage Regulator	16
Linings-Clutch, Brake	8,12	Water Pump	5
Lubrication-Engine Transmission/Transaxle	4,8,9	Weights	26,27
Luggage Compartment	23	Wheel Alignment	15
Models	1	Wheelbase	22
Motor Starting	16	Wheels & Tires	13
Muffler	7	Wheel Spindle	14
		Widths	22
		Windshield	18
		Windshield Wiper and Washer	15