



# 1997 TAHOE

C  
b



GENUINE CHEVROLET





# Tahoe

'97

Dealer Order Guide inserts are your first look at Chevy Truck Models for 1997. Overall improvements, changes and deletions are highlighted. Use these inserts to assist you in ordering your initial shipments. (NOTE: some information is preliminary and is subject to change.)

## Positioning Statement

*The multi-purpose family vehicle with rugged off-road capability and on-the-road comfort and handling.*

FOCUS: Tahoe 4-Door 4x4 with LS Trim and PEG Group 15B



FEATURE: Tahoe 4-door 4x4 with LT trim and PEG Group 15C

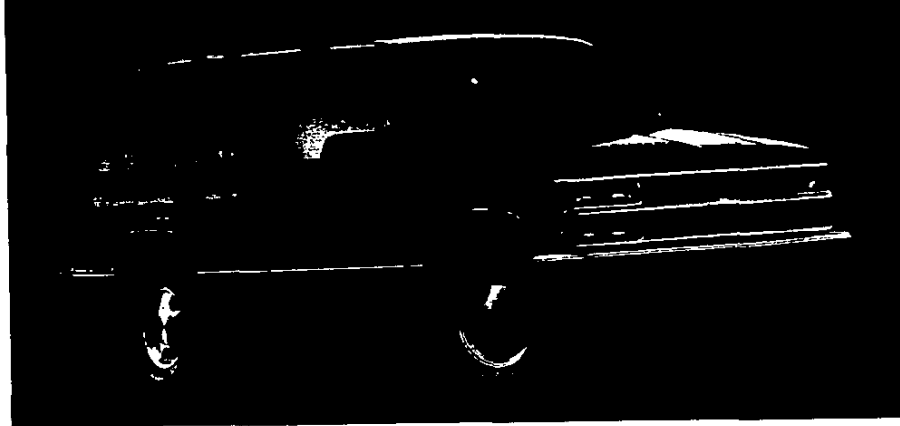

### FOCUS

The Focus vehicle is the model chosen for its saleability. It is equipped with the product features that customers want most. Generally, it is the "volume" vehicle that comprises the majority of the build. You'll want to be sure you have several of these models in stock. NOTE: model, PEG and optional equipment may vary in your locality. Use the Retail Sales Analysis (RSA) to verify or select your dealership's Focus vehicle content.

### Tahoe 4-Door 4x4 with LS Trim and PEG Group 15B (image above, top)

The Focus vehicle for 1997 is Tahoe 4-Door 4x4 with LS trim. It offers an excellent opportunity for Tahoe sales at your dealership.

#### Ordering Recommendations:

The recommended Tahoe LS content, based on national sales volume, is listed below to assist your dealership in ordering.

Tahoe LS with Preferred Equipment Group 15B includes:

- LS Decor (YE9), including Power Door Locks and Power Windows
- Air Conditioning
- 4-Spoke Leather-Wrapped Steering Wheel
- AM/FM Stereo with Seek-Scan, Automatic Tone Control, Digital Clock, Cassette Player, TheftLock and Speed-Compensated Volume Control
- Cast-Aluminum Wheels
- Rear Wiper/Washer (with tailgate/liftglass only)
- Rear-Window Defogger
- Luggage Carrier
- Power Mirrors
- Solar-Ray Deep-Tinted Glass
- Tilt and Cruise.

### FEATURE

The Feature vehicle is the "image" model Chevy Truck will profile most in its advertising. Generally, it does the best job of capturing attention and creating consumer awareness.

### Tahoe 4-door 4x4 with LT trim and PEG Group 15C (image above, bottom)

The Feature vehicle for 1997 is Tahoe 4-Door 4x4 LT. It features luxurious leather seating surfaces in high-back front bucket seats or 60/40 split bench seats.

Tahoe LT with Preferred Equipment Group 15C includes the following equipment which is in addition to or replacing items in PEG 15B:

- Leather Seating Surfaces
- Six-Way Power Driver Seat
- Remote Keyless Entry System.

Tahoe

## Trim Colors

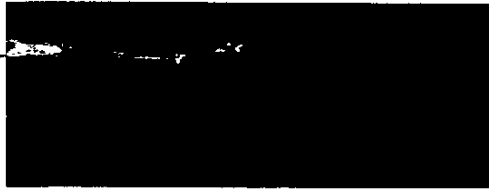

Base vinyl available in Neutral, Blue, Gray and Red (2-door models only).



Custom Cloth available in Neutral, Blue, Gray and Red.



Custom Leather seating surfaces available in Neutral, Blue, Gray and Red.

Tahoe

## Most Popular Exterior Colors with Corresponding Interior Color Availability

### INTERIOR MATERIAL COLORS

	Blue	Gray	Neutral	Red
<b>EXTERIOR COLORS</b>				
Onyx Black		✓	✓	✓
Summit White	✓	✓	✓	✓
Emerald Green Metallic		✓	✓	
Indigo Blue Metallic	✓	✓	✓	

## Seat Styles

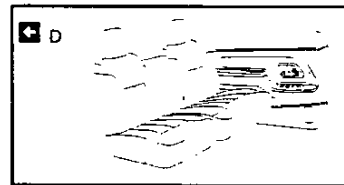
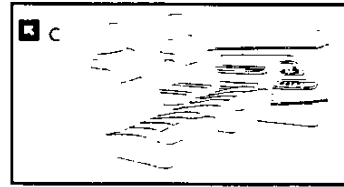
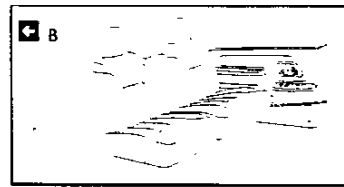
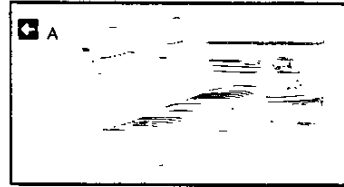

- A. Vinyl reclining low-back bucket seats — Base trim level.
- B. Custom Cloth reclining 60/40 split-bench seat — LS.
- C. Custom Cloth reclining high-back bucket seats — LS.
- D. Custom Leather seating-surfaced reclining 60/40 split-bench seat — LT.
- E. Custom Leather seating-surfaced reclining high-back bucket seats — LT.

## Wheels

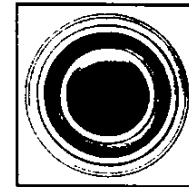

Standard steel wheel, painted argent with black hub ornament — Base (2WD models).

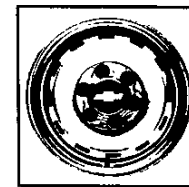

(RPO PO6) Optional Rally Wheel trim with bright trim ring (4x4 models).

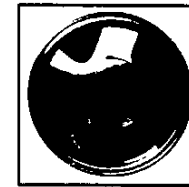

(RPO PF4) Optional 4WD cast-aluminum wheel — standard on LS/LT.



(RPO N90) Optional 15" 2WD cast-aluminum wheel — standard on LS/LT.

## Most Popular Exterior Colors by Percentage

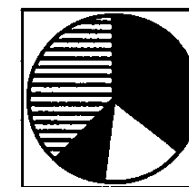

Clockwise at left are the anticipated four most popular Tahoe colors for 1997, based on national sales volume. They are listed for reference only.

To identify the top-selling colors in your area, by model, use the Retail Sales Analysis (RSA).

Onyx Black	19%
Emerald Green Metallic	17%
Summit White	16%
Indigo Blue Metallic	10%
Other colors	38%

NOTE: New Tahoe exterior colors are Medium Opal Blue Metallic and Medium Beige. Mystique Metallic, Atlantic Blue Metallic and Light Autumnwood Metallic have been deleted.



# Tahoe

'97

**P.D.S.E.I.** (New-for-'97 features appear in color.)

*P. D. S. E. I. helps explain 1997 models for this brand. Overall improvements, changes and deletions are highlighted. Please review the supplied information, keeping in mind that this material is provided to you before production startup — and is liable to change.*



## PERFORMANCE

• **SHORTER TURNING RADIUS FOR 4WD MODELS** — provides smaller turning radius for easier maneuvering. • **VORTEC 5700 V8 ENGINE WITH SEQUENTIAL FUEL INJECTION (SFI)** — delivers 255 HP, smooth, quiet operation and extended service intervals. • **6.5L TURBO-DIESEL V8 POWER** — Available on 2-Door 4x4 models. • **CHOICE OF 2- OR 4-DOOR 2WD AND 4X4 MODELS** — Four-wheel drive models feature the Insta-Trac 4x4 system as standard equipment. Insta-Trac lets you shift from free-wheeling 2WD to 4x4 High and back without stopping or slowing down.



## DURABILITY

• **100,000-MILE SPARK PLUGS** — for extended service intervals.\* • **SERPENTINE BELT ACCESSORY DRIVE** — designed to last 100,000 miles. • **NO NEED TO CHECK ENGINE TIMING** — ever. • **LONG-LIFE COOLANT** — designed to last for 5 years/100,000 miles.\* • **ALUMINIZED STAINLESS-STEEL EXHAUST SYSTEM** — designed to resist corrosion. • **BUMPER TO BUMPER LIMITED WARRANTY** — protection for 3 years or 36,000 miles, with no deductible.

\*Maintenance needs vary with use and driving conditions.



## SAFETY

• **FRONT-PASSENGER AIR BAG** — helps prevent injuries to front-seat passenger in certain moderate to severe frontal collisions. Always wear safety belts, even with air bags. • **STANDARD 4-WHEEL ANTI-LOCK BRAKE SYSTEM (ABS)** — helps maintain steering control and minimizes wheel lockup on most slippery surfaces. • **CHILD SECURITY REAR-DOOR LOCKS (4-DOOR MODELS)** — prevent rear-seat passengers from inadvertently opening rear doors from the inside. • **STANDARD DAYTIME RUNNING LAMPS** — help make vehicle more visible during daylight hours.



## EXTERIOR

• **BASECOAT/CLEARCOAT PAINT** — high-gloss shine, long-lasting exterior finish resists fading. • **TWO-SIDE-GALVANIZED STEEL** — on outer-body panels (except roof) provides maximum corrosion protection. • **DUAL REAR PANEL DOORS** — make loading, unloading easy. Liftglass/dropgate available as a no-cost option.



## INTERIOR

• **REAR DOOR LOCK** — provides ability to unlock all doors from switch on right-hand "D" pillar. • **STANDARD SEATING FOR SIX** — (LS or LT with AE7 split-bench seat trim level) and up to 124.5 cu. ft. of cargo room (with rear seatback folded flat) make Tahoe an ideal, spacious, luxurious full-size sport utility. • **CUSTOM LEATHER SEATING SURFACES (LT ONLY)** — beautifully crafted leather seating surfaces with double-stitched French seams make every trip a luxury cruise. • **SCOTCHGARD™ PROTECTOR** — on cloth seats, door panels and carpeting, resists stains for easy cleanup.

### Competitive Models

- Ford Expedition
- Toyota Landcruiser
- Range Rover.

### Additional Information on Significant Features

- An important addition this year is the standard front-passenger air bag. Since safety is a major consideration among today's buyers, the front-passenger air bag helps position Tahoe more solidly than ever as the leader in the full-size sport utility market segment.
- New 4WD improved turning radius. Maneuverability is important to four-wheel drive aficionados, especially those who are off-road enthusiasts. This new system uses revised components and increased turn angles to make possible a shorter turning radius. Affects all 4WD models.

### Deletions

- Two exterior colors have been deleted for 1997: Atlantic Blue Metallic (#30) and Light Autumnwood Metallic (#55) and have been replaced by two new colors: Medium Opal Blue Metallic (#24) and Medium Beige Mystique Metallic (#65).

### Forecasted Percent of Mix

SERIES	
K1500	85.8%
C1500	14.2%
<b>Total</b>	<b>100%</b>

MODELS	
4-Door 4x4	71.6%
4-Door 2WD	12.7%
2-Door 4x4	14.1%
2-Door 2WD	1.6%
<b>Total</b>	<b>100%</b>

TRIM LEVELS	
Base	.2%
LS	34.7%
LT	65.1%
<b>Total</b>	<b>100%</b>

ENGINES	
Vortec 5700 V8 with SFI	99.4%
6.5L Turbo-Diesel V8	.6%
<b>Total</b>	<b>100%</b>

TRANSMISSIONS	
4-Speed Electronically Controlled Automatic with Overdrive	100%
<b>Total</b>	<b>100%</b>

## 1997 NEW PRODUCT HIGHLIGHTS

### TAHOE

AIR BAG FOR FRONT PASSENGER

SPEED SENSITIVE POWER STEERING

DEALERS WILL BE REQUIRED TO ORDER OPTION YG6 (AIR CONDITIONING NOT DESIRED) IF AIR CONDITIONING IS NOT ORDERED OR IS NOT STANDARD.

NEW COLOR MEDIUM MYSTIQUE BEIGE.





10/10/2020



## TAHOE 2-DOOR EQUIPMENT SUMMARY

### STANDARD INTERIOR FEATURES

		BASE	LS	LT
AIR BAGS:	DRIVER'S SIDE AND <i>PASSENGER</i> (FRONT)	S	S	S
CARGO NET:	REMOVABLE REAR COMPARTMENT SECURITY NET	--	S	S
CUPHOLDERS:	DUAL IN DASH	S	S	S
DOOR BEAMS:	SIDE IMPACT	S	S	S
GAGES:	OIL PRESSURE, TACHOMETER, TRIP ODOMETER AND VOLTMETER	S	S	S
GLASS:	SOLAR RAY TINTED, ALL WINDOWS	S	S	S
HEATING DUCT:	REAR SEAT	S	S	S
JACK:	WITH WHEEL WRENCH	S	S	S
LIGHTING:	DOME W/LH & RH DOOR SWITCH W/DELAYED ENTRY FEATURE, READING ASHTRAY, GLOVE-BOX, UNDERHOOD CARGO LAMPS	S	S	S
POWER POINTS:	DUAL COVERED	S	S	S
SCOTCHGARD:	ALL CLOTH AND CARPET SURFACES	S	S	S
SEAT BELTS:	ADJUSTABLE HEIGHT, FRONT	S	S	S
WARNING TONE:	KEY-IN-IGNITION BUZZER	S	S	S

### STANDARD EXTERIOR FEATURES

		BASE	LS	LT
AIR DAM:	DARK ARGENT	S	S	S
KEY:	SINGLE TWO SIDED	S	S	S
LAMPS:	DAYTIME RUNNING	S	S	S
SPARE TIRE:	FULL SIZE SPARE TIRE & WHEEL	S	S	S
TOW HOOKS:	TWO FRONT ON 4X4 MODELS	S	S	S
WIPERS:	INTERMITTENT WINDSHIELD W/PULSE WASHERS	S	S	S
WIRE HARNESS:	7 LEAD TRAILERING	S	S	S

### STANDARD CHASSIS FEATURES

		BASE	LS	LT
BATTERY:	HEAVY-DUTY 600 CCA	S	S	S
BRAKES:	POWER ASSISTED FRONT DISC, REAR DRUM W/4-WHEEL ANTI-LOCK AND TRANSMISSION SHIFT INTERLOCK	S	S	S
ENGINE:	VORTEC 5700 V8 SFI	S	S	S
EXHAUST SYSTEM:	STAINLESS STEEL	S	S	S
FUEL TANK:	30 GAL	S	S	S
GENERATOR:	100 AMP	S	S	S
<b><u>STEERING:</u></b>	<b><u>SPEED SENSITIVE POWER (EVO)</u></b>	S	S	S
STORAGE BOX:	UNDERHOOD, COVERED	S	S	S
SUSPENSION FRT:	INDEPENDENT COIL W/2WD INDEPENDENT TORSION BAR W/4X4	S	S	S
SUSPENSION RR:	MULTI-LEAF SPRINGS	S	S	S
TRANSMISSION	4-SPEED AUTOMATIC W/OVERDRIVE	S	S	S

**BOLD, ITALICS AND UNDERLINED INDICATES NEW FOR '97**

REVISED: 8-19-96

1997 ORDER GUIDE

TAHOE  
Page 1

Prices Shown Are Manufacturer's Suggested Retail Prices (MSRP) At The Time Of Publication. These Prices Are To Be Used Only As An Aid To Inventory Management Since MSRP Figures Change Periodically. The Vehicle Price Schedule Is The Official Pricing Documentation Of Chevrolet Motor Division And Should Be Used In Discussing Vehicle Prices With Potential Buyers. The Model Prices Shown In The Order Guide Include The Destination Freight Charges.

## TAHOE 2-DOOR TRIM DEFINITION & OPTION SUMMARY

### INTERIOR TRIM

	BASE	LS	LT
AIR CONDITIONING:	--	S	S
ASSIST HANDLES: RH FRONT SEAT -- LH & RH REAR SEAT	S	S	S
CONVENIENCE GP: POWER WINDOWS, LOCKS	--	S	S
POWER LOCKS ONLY	S	--	--
TILT WHEEL AND CRUISE CONTROL	--	S	S
DOOR TRIM: MOLDED PLASTIC W/ARMREST	S	--	--
COLOR-KEYED CLOTH AND CARPET TRIM	--	S	S
FLOOR COVERING: FULL BLACK RUBBER	S	--	--
COLOR-KEYED CARPET W/RUBBER MATS	--	S	S
GLASS: DEEP TINT	--	S	S
HEADLINER: COLOR-KEYED CLOTH	S	S	S
MAP POCKETS: IN PASSENGER & DRIVER'S DOOR	S	S	S
MIRROR: 10" ELECTROCHROMIC ISRV WITH 8 POINT COMPASS	--	S	S
RADIO: AM/FM STEREO W/SEEK & SCAN	S	--	--
AM/FM STEREO W/SEEK & SCAN, CLOCK AND CASSETTE TAPE W/AUTO TONE CONTROL	--	S	S
SEATING FRT: VINYL LOW BACK BUCKET SEATS	S	--	--
CUSTOM CLOTH 60/40 SPLIT BENCH	--	S	--
LEATHER 60/40 SPLIT BENCH	--	--	S
SEATING RR: 3 PASSENGER FOLDING	S	S	S
SPARE TIRE COVER: COLOR-KEYED, CLOTH COVER	--	S	S
STEERING WHEEL: SIMULATED LEATHER	S	--	--
LEATHER WRAPPED	--	S	S
SUNSHADES: CLOTH W/LH STORAGE STRAP & RH MIRROR	S	--	--
LH STORAGE STRAP & LH/RH LIGHTED MIRROR W/EXTENDERS	--	S	S

### EXTERIOR TRIM

	BASE	LS	LT
BUMPERS FRT: CHROME WITH BLACK RUB STRIPS & BRIGHT TRIM	S	S	S
BUMPER RR: CHROME WITH STEP PAD	S	S	S
CARRIER: ROOF MOUNTED LUGGAGE CARRIER	--	S	S
GRILLE: MOLDED PAINTED ARGENT	S	--	--
CHROME DELUXE	--	S	S
HEADLAMPS: SINGLE RECTANGULAR HALOGEN	S	--	--
DUAL COMPOSITE HALOGEN	--	S	S
HORN: SINGLE NOTE	S	--	--
DUAL NOTE	--	S	S
MIRRORS: BREAK-A-WAY OSRV, BLACK	S	--	--
ELECTRIC REMOTE CONTROL, BLACK	--	S	S
MOLDINGS: BODY SIDE WITH BRIGHT TRIM AND BRIGHT WHEEL OPENING TRIM	S	S	S
PAINT: SINGLE TONE	S	S	S
WHEELS: SILVER PAINTED W/BLACK CENTER CAP	S	--	--
ALUMINUM	--	S	S

**BOLD, ITALICS AND UNDERLINED INDICATES NEW FOR '97**

**TAHOE**

**1997 ORDER GUIDE**

**REVISED: 8-19-96**

Page 2

Prices Shown Are Manufacturer's Suggested Retail Prices (MSRP) At The Time Of Publication. These Prices Are To Be Used Only As An Aid To Inventory Management Since MSRP Figures Change Periodically. The Vehicle Price Schedule Is The Official Pricing Documentation Of Chevrolet Motor Division And Should Be Used In Discussing Vehicle Prices With Potential Buyers. The Model Prices Shown In The Order Guide Include The Destination Freight Charges.

**MODEL AND BODY**

Description	Model No	Body	Wheel Base
TAHOE 2-Wheel Drive ...	CC10516	ZW9	111.5
TAHOE 4-Wheel Drive ...	CK10516	ZW9	111.5

**EMISSIONS (Must Order One) (Refer Emission Requirements Section)**

- FE9 Federal Emission Requirements
- YF5 California Emission Requirements
- NG1 New York/Massachusetts State Emission Requirements
- NB8 California or New York/Massachusetts State Emission Override (Reqs FE9 Federal Emissions)
- NC7 Federal Emission Override (Reqs YF5 California or NG1 New York/Massachusetts State Emissions)

**POWER TEAMS (Must Order Engine, Transmission and Rear Axle)**

(Consult GVWR Selector For Minimum Equipment Required)

ENGINE	TRANSMISSION	AXLES	GVWR
	AUTO	3.08 3.42 3.73	
	Lt Duty / H Duty		
<b>C10516</b>			
L31 5700 Vortec V8 (350 Cu In)--SFI	M30	GU4 GU6	6100
<b>K10516</b>			
L31 5700 Vortec V8 (350 Cu In)--SFI	M30	GU6 GT4	6250
L56 V8 Turbo Diesel 6.5 Liter (400 Cu In)	MT1	(a) GU6 (a) GT4	6450

(a) N/A YF5 Emissions

**GVWR SELECTOR (MUST SPECIFY GVW OPTION)**

GVW OPT	GVW Rating (lbs)	Minimum Equipment Required For GVW Rating		
		(a) GAWR (lbs)		
		Front	Rear	
C5M	6100	3200	3686	Reqs C10516
C5P	6250	3925	3750	N/A L56 Eng or C10516
C7I	6450	3925	3750	Reqs L56 Eng and K10516

(a) GAWR's shown are the minimum for each axle with equipment listed. Other GAWR's are available

**CAPACITIES**

C10516			
SPRINGS:		AXLES:	
Front		Front	
3200	Base	3600	Base
Rear		Rear	
3750	Base	3750	Base

K10516			
SPRINGS:		AXLES:	
Front		Front	
3925	Base	3925	Base
Rear		Rear	
3750	Base	3750	Base

**MUST SPECIFY:**

**AXLE, BODY CODE, EMISSION, ENGINE, TIRES AND TRANSMISSION**

**No Deletions Allowed. Additional Options/Upgrades (Where Indicated) May be Ordered from the Custom Ordering Option Listing.**

				Decor		
				BASE	LS	LT
				1	1	1
				S	S	S
				A	B	C
<b>BASE DECOR</b> .....				X	--	--
<b>LS DECOR</b> .....					X	--
			Air Conditioning..... C60		X	X
			ATC Stereo Cassette (A)..... ULO		X	X
			Glass, Deep Tinted..... AJ1		X	X
			Rear Wiper/Washer w/Defogger (E55 Body Only)..... ZP6		X	X
			Rear Window Defogger (ZW9 Only)..... C49		X	X
<b>LT DECOR</b> .....						X
			Power Seat..... AG9			X
			Remote Keyless Entry..... AU0			X
			60/40 Split Bench Seat (B)..... AE7			X

(A) May upgrade  
 (B) Must Specify Trim Color, May Upgrade To A95 Bucket Seats

**SPORT PACKAGE: Ordering Option BYP**

Reqs PEG 1SB or 1SC  
 Reqs L31 Eng, QGA or QGC Tires  
 N/A 2-Wheel Drive  
 (Refer Page 9 for available Paint and Trim Applications)

Includes:  
 Dark Argent Colored  
 Uplevel Grille, Wheel Flares, Front Bumper w/Rubber Strip,  
 Rear Bumper w/Rubber Strip and Step Pad

Black Colored  
 Front License Bracket  
 Front Air Dam  
 Mirrors  
 Sport Decals

ADDITIONAL OPTIONS

INCL W/DECOR			OPTION	DESCRIPTION
Base	LS	LT		
			R8S	Multiple Order Numbers
			R8T	Preliminary Invoice (Refer Vehicle Price Schedule)
			K47	AIR CLEANER: High Capacity (N/A Diesel)
			YG6	AIR CONDITIONING: (One Of The Following Options Must Be Ordered w/PEG 1SA)
			C60	Air Conditioning Not Desired Air Conditioning: (Incls R134A Refrigerant) w/1SB or 1SC w/1SA
				AXLES, REAR: (Refer Power Teams Chart for Availability)
			GU4	3.08 Ratio
			GU6	3.42 Ratio
			GT4	3.73 Ratio
			G80	Locking Differential (C10516 Reqs GU6 Axle)
				BODY CODE: (Must Specify One)
			ZW9	Base, Panel Door
			E55	Tailgate (Lift Glass w/Drop Gate and Power Release)
			Z71	CHASSIS EQUIPMENT: Off-Road Package (Reqs QGC w/BYP Sport Pkg) (Incls NZZ Skid Plate Pkg and Bilstein Shock Absorbers) (w/o BYP Sport Pkg, Reqs QGC, QGD, QBN or QBX Tires)
N/A			V10	COLD CLIMATE PACKAGE: (Incls Eng Block Heater) (Reqs L31 Eng)
			Z03	CONVENIENCE GROUP: Tilt Wheel and Speed Control w/1SB or 1SC w/1SA
				COOLING SYSTEM: (Eng Oil Cooler comparable to KC4 is Std with GT4 Axle and/or Diesel Eng)
			KC4	Engine Oil (Reqs L31 Eng) (N/A GT4 Axle) w/Z82 w/o Z82
			KNP	Transmission, Heavy-Duty, Auxiliary (Reqs L31 Eng) (N/A GU4 Axle) (Incl w/MT1 Trans) w/MT1 or Z82 and M30 w/o MT1 or w/o Z82 and M30
			C49	DEFOGGER: Rear Window, Electric (Reqs ZW9 Body and C60 Air) w/1SB or 1SC w/1SA
				EMISSIONS: (Refer Emission Requirement Tab Section)
			FE9	Federal Emission Requirements
			YF5	California Emission Requirements
			NG1	New York/Massachusetts Emission Requirements
			NB8	California or New York/Massachusetts Emission Override (Reqs FE9 Federal Emissions)
			NC7	Federal Emission Override (Reqs YF5 California or NG1 New York/Massachusetts Emissions)
				ENGINES: (Refer Power Teams Chart)
			L31	Vortec 5700 V8 (350 Cu In)-SFI
			L56	6.5 Liter V8 (400 Cu In)-Turbo Diesel (Incls Front Bumper Guards) (N/A BYP Sport Pkg) (Deletes Underhood Storage Box)
			AJ1	GLASS: Deep Tinted w/1SB or 1SC w/1SA
				GVWR: (Must Specify One) (Refer GVWR Selector Chart for Availability)
			C5M	6100#
			C5P	6250#
			C71	6450#
N/A			AU0	KEYLESS ENTRY: Remote w/1SC w/1SB
			VK3	LICENSE PLATE BRACKET: Front
			DF2	MIRROR: Camper Type Stainless Steel, 7.5" W x 10.5" H, Exterior (N/A BYP Sport Pkg) w/1SB or 1SC w/1SA
			B71	MOLDING: Wheel Flares (Refer Color/Trim Charts For Availability) (Incl w/ BYP Sport Pkg) (N/A C10516) w/BYP w/o BYP
				PAINT, EXTERIOR: (Refer Color/Trim Charts for Availability)
			ZY1	Solid (N/A BYP Sport Pkg)
N/A			ZY2	Conventional Two-Tone w/BYP w/o BYP

ADDITIONAL OPTIONS

INCL W/DECOR			OPTION	
Base	LS	LT		
N/A	N/A x	N/A x	UM6 UL0	<b>RADIO EQUIPMENT:</b> Electronically Tuned AM/FM Stereo Radio w/Seek-Scan, Digital Clock and Cassette Tape
N/A			UN0	Electronically Tuned AM/FM Stereo Radio w/Seek-Scan, Digital Clock, Automatic Tone Control, Compact Disc Player, Theft Lock and Speed Compensated Volume (Incls Enhanced Performance Speaker System)
N/A			UPO	Electronically Tuned AM/FM Stereo Radio w/Seek-Scan, Digital Clock, Automatic Tone Control, Compact Disc Player, Theft Lock and Speed Compensated Volume (Incls Enhanced Performance Speaker System)
	N/A x	N/A x	UL5 ZP6	Radio Delete <b>REAR WINDOW EQUIPMENT: Wiper/Washer System with Defogger (Incls Wiper Washer System; Also includes Rear Window Defogger) (Reqs E55 Body) w/1SB or 1SC</b>
N/A		x	AG9	<b>SEAT: Power Driver's Seat</b> w/1SC w/o 1SC
	N/A	N/A	A50 AE7 A95	<b>SEAT TYPE: (Refer Color/Trim Chart for Availability)</b> Reclining Back Bucket Seat Reclining 60/40 Split Bench Seat (Incls Storage Armrest and Power Lumbar w/Custom Cloth or Leather Trim) Reclining High Back Bucket Seats (Incls Center and Roof Console and Power Lumbar) w/1SC w/1SA or 1SB
			NZZ	<b>SKID PLATE PACKAGE: (N/A C10516)</b> w/Z1 w/o Z1
N/A			BYP	<b>SPORT PACKAGE: (Refer Standard Features Page 2 for Package Content) (Reqs K10516 and ZY2 Paint Application)</b>
			F60	<b>SPRINGS: Front, Heavy-Duty (Reqs L31 Eng)</b>
			BVE	<b>STEP RUNNING BOARD: Side, Black (Supports 600 lbs) (Dealer Installed)</b>
			QFL QFN	<b>TIRES: Tubeless (BW - Blackwall; WOL - White Outlined Letters; WL - White Letters) (Front, Rear and Spare)</b> <b>C10516 Only</b> P235/75R15 All Seasons Steel Belted Radial Ply B/W P235/75R-15 All Seasons Steel Belted Radial Ply W/L
			QBN QBX QGA QGC QGD	<b>K10516 Only</b> LT245/75R16-C On-Off Road Steel Belted Radial Ply B/W LT245/75R16-C On-Off Road Steel Belted Radial Ply WOL P245/75R16 All Terrain Steel Belted Radial Ply B/W P265/75R16 All Terrain Steel Belted Radial Ply B/W (Reqs PF4 Wheels) P265/75R16 All Terrain Steel Belted Radial Ply WOL (Reqs PF4 Wheels)
			V76 Z82	<b>TOW HOOKS: (Std K1500)</b> <b>TRAILERING SPECIAL EQUIPMENT: Heavy-Duty (Incls Trailer Hitch Platform and Wiring Harness) (Incls KC4 Eng Oil Cooler and KNP Transmissions Oil Cooler Where Available)</b> w/Diesel Eng or GT4 Axle w/o Diesel Eng or GT4 Axle
			NP1	<b>TRANSFER CASE: Electronic Shift Control, 2-Speed (Reqs 4-Wheel Drive) (Reqs ZQ3 Convenience Pkg or LS/LT Decor)</b>
			M30 MT1	<b>TRANSMISSIONS: (Refer Power Teams Chart)</b> 4-Speed Electronically Controlled Automatic w/Overdrive 4-Speed Electronically Controlled Automatic w/Overdrive, Heavy-Duty
	N/A	N/A	PO6	<b>WHEEL TRIM: Rally (N/A PF4 Wheels)</b>
	x	x	N90	<b>WHEELS:</b> Aluminum (Spare is Steel) (2-Wheel Drive Only) w/1SB or 1SC w/1SA
	x	x	PF4	Aluminum (Spare is Steel) (4-Wheel Drive Only) w/1SB or 1SC w/1SA

# TAHOE 2-DOOR

## PAINT APPLICATIONS WITH ZY1 AND ZY2 PAINT W/O BYP SPORT PACKAGE

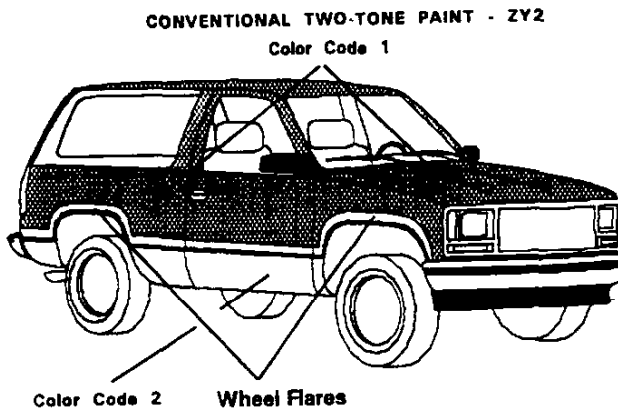
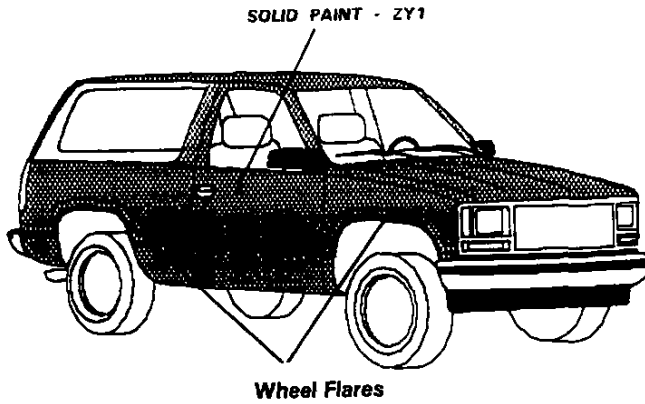



**TAHOE 2-DOOR**  
**INTERIOR AND EXTERIOR COLOR AVAILABILITY CHART**  
**ZY1 PAINT (N/A BYP SPORT PACKAGE)**

**PLEASE NOTE:** Below are the interior trim color and exterior paint combinations recommended by Chevrolet. They are the only available interior and exterior combinations allowed.

TRIM LEVEL (Must Specify Seat Option and Interior Color)	SEAT OPT	INTERIOR COLORS					
		Neutral	Blue	Gray	Red		
<b>BASE (STD DECOR)</b> Vinyl Reclining Back Bkt Seats	A50	52V	26V	13V	79V		
<b>LS PACKAGE</b> Custom Cloth Reclining Split Bench Seat Custom Cloth Reclining High Back Bucket Seats (Incls Roof/Floor Console)	AE7 A95	52D 52D	26D 26D	13D 13D	79D 79D		
<b>LT PACKAGE</b> *Custom Leather Reclining Split Bench Seats *Custom Leather Reclining High Back Bkt Seats (Incls Roof/Floor Console)	AE7 A95	52Z 52Z	26Z 26Z	13Z 13Z	79Z 79Z		
EXTERIOR COLORS w/ZY1 PAINT	Color Code 1	Paint Scheme	INTERIOR & EXTERIOR COMBINATIONS SHOWN ARE THE ONLY COMBINATIONS AVAILABLE				WHEEL FLARE COLOR MOLDING
^ BEIGE, MYSTIQUE MED (Met)	65U	ZY1	x		x		Dk Argent
BLACK, ONYX	48U	ZY1	x		x	x	Black
BLUE, INDIGO (Met)	39U	ZY1	x	x	x		Blue, Indigo
CHERRY ICE (Met)	59U	ZY1	x		x	x	Dk Argent
GREEN, EMERALD (Met)	43U	ZY1	x		x		Dk Argent
QUICKSILVER (Met)	96U	ZY1		x	x	x	Silver
RED, CHERRY (Met)	77U	ZY1	x		x	x	Red, Cherry
RED, VICTORY	74U	ZY1	x		x	x	Dk Argent
WHITE, SUMMIT	50U	ZY1	x	x	x	x	Dk Argent

\* Leather on Seating Surface Only

**INTERIOR AND EXTERIOR COLOR AVAILABILITY CHART**  
**ZY2 PAINT (Reqs LS/LT Decor)**

EXTERIOR COLORS w/ZY2 PAINT	Color Code 1	**Color Code 2	Paint Scheme	INTERIOR & EXTERIOR COMBINATIONS SHOWN ARE THE ONLY COMBINATIONS AVAILABLE				WHEEL FLARE COLOR MOLDING
^ BEIGE, MYSTIQUE MED (Met)/Black Onyx (Met)	65U	41L	ZY2	x				Black, Onyx
BEIGE, MYSTIQUE MED (Met)/Red, Cherry (Met)	65U	77L	ZY2	x			x	Red, Cherry
^ BLACK, ONYX/Autumnwood, Lt (Met)	41U	55L	ZY2	x				Autumnwood
+ BLACK, ONYX/Beige, Mystique Med (Met)	41U	65L	ZY2	x				N/A
BLACK, ONYX/Quicksilver (Met)	41U	96L	ZY2			x	x	Silver
+ BLACK, ONYX/Red, Victory	41U	74L	ZY2			x		N/A
BLUE, INDIGO (Met)/Quicksilver (Met)	39U	96L	ZY2		x	x		Silver
^ CHERRY ICE (Met)/Autumnwood, Lt (Met)	59U	55L	ZY2	x			x	Autumnwood
CHERRY ICE (Met)/Quicksilver (Met)	59U	96L	ZY2			x	x	Quicksilver
CHERRY ICE (Met)/Red, Cherry (Met)	59U	77L	ZY2	x		x	x	Red, Cherry
^ GREEN, EMERALD (Met)/Autumnwood, Lt (Met)	43U	55L	ZY2	x				Autumnwood
+ GREEN, EMERALD (Met)/Beige, Mystique (Met)	43U	65L	ZY2	x				N/A
GREEN, EMERALD (Met)/Quicksilver (Met)	43U	96L	ZY2			x		Quicksilver
QUICKSILVER (Met)/Black, Onyx	96U	41L	ZY2			x	x	Black
QUICKSILVER (Met)/Blue, Indigo (Met)	96U	39L	ZY2		x	x		Blue, Indigo
+ QUICKSILVER (Met)/Cherry Ice (Met)	96U	59L	ZY2			x	x	N/A
^ QUICKSILVER (Met)/Red, Cherry (Met)	96U	77L	ZY2			x	x	Red, Cherry
+ RED, CHERRY (Met)/Beige, Mystique Med (Met)	77U	65L	ZY2	x			x	N/A
+ RED, CHERRY (Met)/Cherry Ice (Met)	77U	59L	ZY2	x		x	x	N/A
RED, CHERRY (Met)/Quicksilver (Met)	77U	96L	ZY2			x	x	Quicksilver
^ RED, VICTORY/Black, Onyx (Met)	74U	41L	ZY2			x	x	Black, Onyx
^ RED, VICTORY/Quicksilver (Met)	74U	96L	ZY2			x	x	Quicksilver
^ WHITE, SUMMIT/Autumnwood, Lt (Met)	50U	55L	ZY2	x				Autumnwood
+ WHITE, SUMMIT/Beige, Mystique Med (Met)	50U	65L	ZY2	x				N/A
WHITE, SUMMIT/Blue Indigo (Met)	50U	39L	ZY2		x			Blue, Indigo
+ WHITE, SUMMIT/Cherry Ice (Met)	50U	59L	ZY2	x		x	x	N/A
^ WHITE, SUMMIT/Red, Cherry (Met)	50U	77L	ZY2				x	Red, Cherry

+ N/A B71 Molding or K10906 w/L65 Eng or on K20906  
\* Color Code 2 Must be ordered as a (+) Plus Option

**BYP SPORT TAHOE 2-DOOR  
INTERIOR AND EXTERIOR COLOR AVAILABILITY CHART  
ZY2 TWO-TONE PAINT WITH BYP SPORT EQUIPMENT PACKAGE**

**PLEASE NOTE:** Below are the interior trim color and exterior paint combinations recommended by Chevrolet. They are the only available interior and exterior combinations allowed.

TRIM LEVEL (Must Specify Seat Option and Interior Color) Seat Type	SEAT OPT	INTERIOR COLORS			
		Neutral	Blue	Gray	Red
<b>LS PACKAGE</b>					
Custom Cloth Reclining Split Bench Seat	AE7	52D	26D	13D	79D
Custom Cloth Reclining High Back Bucket Seats (Incls Roof/Floor Console)	A95	52D	26D	13D	79D
<b>L7 PACKAGE</b>					
*Custom Leather Reclining Split Bench Seat	AE7	522	262	132	792
*Custom Leather Reclining High Back Bkt Seats	A95	522	262	132	792

EXTERIOR COLORS w/ZY2 PAINT	Color Code 1	**Color Code 2	PAINT SCHEME	INTERIOR & EXTERIOR COMBINATIONS SHOWN ARE THE ONLY COMBINATIONS AVAILABLE				WHEEL FLARE
BEIGE, MYSTIQUE MED (Met)/Gray, Gunmetal (Met)	65J	91L	ZY2	x		x		Dk Argent
BLACK, ONYX/Gray, Gunmetal (Met)	41U	91L	ZY2	x		x	x	Dk Argent
CHERRY ICE (Met)/Gray, Gunmetal (Met)	59J	91L	ZY2	x		x	x	Dk Argent
GREEN, EMERALD (Met)/Gray, Gunmetal (Met)	43J	91L	ZY2	x		x		Dk Argent
QUICKSILVER (Met)/Gray, Gunmetal (Met)	96J	91L	ZY2		x	x	x	Dk Argent
RED, CHERRY (Met)/Gray, Gunmetal (Met)	77J	91L	ZY2	x		x	x	Dk Argent
RED, VICTORY/Gray, Gunmetal (Met)	74J	91L	ZY2	x		x		Dk Argent
WHITE, SUMMIT/Gray, Gunmetal (Met)	50J	91L	ZY2	x	x	x	x	Dk Argent

**NOTE:** W/B71, Wheel Flare Color Matches Color Code 2

- \* Leather on Seating Surface Only
- \*\* Color Code 2 Must be ordered as a (+) Plus option

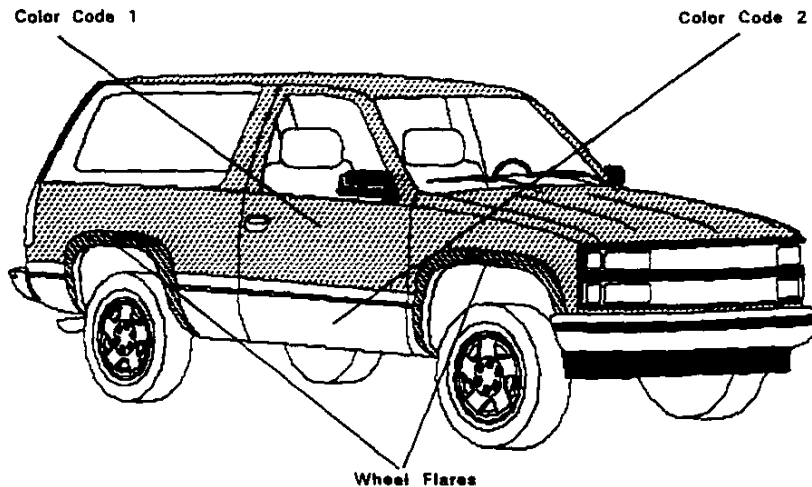

# **NOTES**

## TAHOE 4-DOOR EQUIPMENT SUMMARY

### STANDARD INTERIOR FEATURES

		LS	LT
AIR BAGS:	DRIVER'S SIDE AND <i>PASSENGER</i> (FRONT)	S	S
CARGO NET:	REMOVABLE REAR COMPARTMENT SECURITY NET	S	S
CARGO SHADE:	REMOVABLE REAR CARGO SECURITY SHADE	S	S
COAT HOOKS:	2 LH & 2 RH MOUNTED ABOVE REAR SEAT AND IN CARGO AREA	S	S
CUPHOLDERS:	DUAL IN DASH	S	S
<b><i>DEFOGGER:</i></b>	<b><i>ELECTRIC REAR WINDOW</i></b>	S	S
DOOR BEAMS:	SIDE IMPACT	S	S
GAGES:	ENGINE TEMP, OIL PRESSURE, TACHOMETER, TRIP ODOMETER AND VOLTMETER	S	S
GLASS:	SOLAR RAY LIGHT TINTED, FRONT AND REAR SIDE WINDOWS	S	S
HEATING DUCT:	REAR SEAT	S	S
JACK:	WITH WHEEL WRENCH	S	S
LIGHTING:	FRONT & REAR DOME, FRONT FOOT WELL, W/LH & RH DOOR SWITCH W/DELAYED ENTRY FEATURE, READING, ASHTRAY, GLOVE-BOX, UNDERHOOD AND CARGO LAMPS. REAR DOOR LIGHT SWITCH	S	S
MIRROR:	10" ELECTROCHROMIC ISRV WITH 8 POINT COMPASS	S	S
POWER POINTS:	DUAL COVERED	S	S
SCOTCHGARD:	ALL CLOTH AND CARPET SURFACES	S	S
SEAT BELTS:	ADJUSTABLE HEIGHT, FRONT & REAR	S	S
STORAGE BIN:	LEFT REAR QUARTER PANEL	S	S
WARNING TONE:	KEY-IN-IGNITION AND HEADLAMPS-ON BUZZERS	S	S

### STANDARD EXTERIOR FEATURES

		LS	LT
AIR DAM:	DARK ARGENT	S	S
KEY:	SINGLE TWO SIDED	S	S
LAMPS:	DAYTIME RUNNING	S	S
SPARE TIRE:	UNDER BODY FULL SIZE TIRE MOUNTED ON STEEL WHEEL	S	S
TIRES:	2WD: FIVE P235/75R-15 ALL SEASON STEEL BELTED RADIALS	S	S
	4WD: FIVE P245/75R-16 ALL TERRAIN STEEL BELTED RADIALS	S	S
TOW HOOKS:	TWO BLACK FRONT FRAME MOUNTED ON 4X4 MODELS	S	S
WIPERS:	INTERMITTENT WINDSHIELD W/PULSE WASHERS	S	S
	REAR WINDOW WIPER W/E55 BODY	S	S
WIRE HARNESS:	7 LEAD TRAILERING	S	S

### STANDARD CHASSIS FEATURES

		LS	LT
BATTERY:	HEAVY-DUTY 600 CCA	S	S
BRAKES:	POWER ASSISTED FRONT DISC, REAR DRUM W/4-WHEEL ANTI-LOCK AND TRANSMISSION SHIFT INTERLOCK	S	S
ENGINE:	VORTEC 5700 V8 SFI	S	S
EXHAUST SYSTEM:	STAINLESS STEEL	S	S
FUEL TANK:	30 GAL	S	S
GENERATOR:	100 AMP	S	S
<b><i>STEERING:</i></b>	<b><i>SPEED SENSITIVE, POWER (EVO)</i></b>	S	S
STORAGE BOX:	UNDERHOOD, COVERED	S	S
SUSPENSION FRT:	INDEPENDENT COIL W/2WD INDEPENDENT TORSION BAR W/4X4	S	S
SUSPENSION RR:	MULTI-LEAF SPRINGS	S	S
TRANSMISSION:	4-SPEED ELECTRONIC ONTROLLED AUTOMATIC W/OVERDRIVE	S	S

**BOLD, ITALICS AND UNDER LINED INDICATES NEW FOR '97**

REVISED: 8-19-96

1997 ORDER GUIDE

TAHOE  
Page 11

Prices Shown Are Manufacturer's Suggested Retail Prices (MSRP) At The Time Of Publication. These Prices Are To Be Used Only As An Aid To Inventory Management Since MSRP Figures Change Periodically. The Vehicle Price Schedule Is The Official Pricing Documentation Of Chevrolet Motor Division And Should Be Used In Discussing Vehicle Prices With Potential Buyers. The Model Prices Shown In The Order Guide Include The Destination Freight Charges.

## TAHOE 4-DOOR TRIM DEFINITION & OPTION SUMMARY

### INTERIOR TRIM

	LS	LT
AIR CONDITIONING:	S	S
ASSIST HANDLES: FRONT SEAT - 1 RH ROOF & 1 RH "A" PILLAR MOUNTED	S	S
REAR SEAT - 2 LH/RH ROOF & 2 LH/RH "B" PILLAR MOUNTED	S	S
CONVENIENCE GP: POWER WINDOWS, LOCKS <u>(INCLS CARGO AREA LOCK SWITCH)</u>	S	S
TILT WHEEL AND CRUISE CONTROL	S	S
DOOR TRIM: SOFT VINYL WITH CLOTH INSERTS	S	S
FLOOR COVERING: COLOR-KEYED CARPET W/FRONT & REAR RUBBER MATS	S	S
GLASS: DEEP TINTED	S	S
HEADLINER: COLOR-KEYED CLOTH	S	S
MAP POCKETS: IN PASSENGER & DRIVER'S DOOR	S	S
RADIO: AM/FM STEREO W/SEEK & SCAN, CASSETTE TAPE & AUTO TONE CONTROL	S	S
RADIO SPEAKERS: FRONT -- 2-DOOR SPEAKERS, 2 ARMREST MOUNTED TWEETERS AND REAR -- 2 SIDE DOOR AND 2 HEADLINER MOUNTED SPEAKERS	S	S
SEATING FRT: 60/40 SPLIT BENCH CUSTOM CLOTH	S	--
LEATHER 60/40 SPLIT BENCH	--	S
SEATING RR: 3 PASSENGER FOLDING, 60/40 SPLIT BENCH WITH CENTER ARMREST W/INTEGRAL DUAL CUP AND TISSUE HOLDER	S	S
STEERING WHEEL: LEATHER WRAPPED	S	S
SUNSHADES: COLOR-KEYED CLOTH W/ILLUMINATED MIRRORS AND EXTENDERS LH W/STORAGE STRAP	S	S

### EXTERIOR TRIM

	LS	LT
BUMPER FRT: CHROME W/BLACK RUB STRIPS & BRIGHT TRIM	S	S
BUMPER REAR: CHROME W/BLACK RUB STRIP AND STEP PAD	S	S
CARRIER: ROOF MOUNTED LUGGAGE CARRIER	S	S
GRILLE: CHROME DELUXE	S	S
HEADLAMPS: DUAL COMPOSITE HALOGEN	S	S
HORN: DUAL NOTE	S	S
MIRRORS: BLACK ELECTRIC OSRV (8.5W X 5.0"H)	S	S
MOLDINGS: BLACK BODY SIDE WITH BRIGHT TRIM AND BRIGHT WHEEL OPENING TRIM	S	S
NAMEPLATES: LS BADGE ON B-PILLAR	S	--
LT BADGE ON B-PILLAR	--	S
PAINT: SINGLE TONE	S	S
WHEELS: 2WD -- FOUR 15" X 7" CAST ALUMINUM	S	S
4WD -- FOUR 16" X 6.5" CAST ALUMINUM	S	S

**BOLD, ITALICS AND UNDER LINED INDICATES NEW FOR '97**

**TAHOE**

**1997 ORDER GUIDE**

**REVISED: 8-19-96**

Page 12

Prices Shown Are Manufacturer's Suggested Retail Prices (MSRP) At The Time Of Publication. These Prices Are To Be Used Only As An Aid To Inventory Management Since MSRP Figures Change Periodically. The Vehicle Price Schedule Is The Official Pricing Documentation Of Chevrolet Motor Division And Should Be Used In Discussing Vehicle Prices With Potential Buyers. The Model Prices Shown In The Order Guide Include The Destination Freight Charges.

**MODEL AND BODY**

Description	Model No	Body	Wheel Base
TAHOE 2-Wheel Drive ....	CC10706	ZW9/E55	117.5
TAHOE 4-Wheel Drive ....	CK10706	ZW9/E55	117.5

\*Includes Destination & Handling Charges

**EMISSIONS (Must Order One) (Refer Emission Requirements Section)**

- FE9 Federal Emission Requirements
- YF5 California Emission Requirements
- NG1 New York/Massachusetts State Emission Requirements
- NB8 California or New York/Massachusetts State Emission Override (Reqs FE9 Federal Emissions)
- NC7 Federal Emission Override (Reqs YF5 California or NG1 New York/Massachusetts State Emissions)

**POWER TEAMS (Must Order Engine, Transmission and Rear Axle)**

(Consult GVWR Selector For Minimum Equipment Required)

ENGINE	TRANSMISSION	AXLES		GVWR
	AUTO	3.42	3.73	
<b>C-K10706</b>				
L31 Vortec 5700 V8 (350 Cu In) SFI	M30	GU6	GT4	6300/6800

**GVWR SELECTOR (MUST SPECIFY GVW OPTION)**

GVW OPT	GVW Rating (lbs)	Minimum Equipment Required For GVW Rating		
		(a) GAWR (lbs)		
		Front	Rear	
C5Q	6300	3200	3686	C10706 Only
C5U	6800	3600	3750	K10706 Only

(a) GAWR's shown are the minimum for each axle with equipment listed. Other GAWR's are available and they are determined as the minimum capacity of either axle, springs or tires.

**CAPACITIES**

C10706 SPRINGS:		AXLES:	
Front		Front	
3200	Base	3600	Base
Rear		Rear	
3750	Base	3750	Base

**CAPACITIES**

K10706 SPRINGS:		AXLES:	
Front		Front	
3600	Base	3925	Base
Rear		Rear	
3750	Base	3750	Base

**TAHOE 4-DOOR**

**MUST SPECIFY:**

**AXLE, BODY CODE, EMISSION, ENGINE, TIRES AND TRANSMISSION**

**No Deletions Allowed. Additional Options/Upgrades (Where Indicated) May be Ordered from the Custom Ordering Option Listing.**

		Decor	
		LS	LT
		1	1
		S	S
		B	C
LS DECOR .....		X	--
LT DECOR .....			X
Power Seat .....		AG9	X
Remote Keyless Entry .....		AU0	X
60/40 Split Bench Seat (A) .....		AE7	X

(A)Must Specify Trim Color, May Upgrade To A95 Bucket Seats

ADDITIONAL OPTIONS

INCL W/DECOR		OPTION
LS	LT	
		<b>ACKNOWLEDGEMENTS</b> R8S Multiple Order Numbers R8T Preliminary Invoice (Vehicle Price Schedule)
		K47 <b>AIR CLEANER</b>
		<b>AXLES, REAR:</b> (Refer Power Teams Chart for Availability)
		GU6 3.42 Ratio
		GT4 3.73 Ratio
		G80 Locking Differential
		<b>BODY CODE:</b> (Must Order One)
		ZW9 Base, Panel Door
		E55 Tailgate (Lift Glass w/Drop Gate and Power Release)
		V10 <b>COLD CLIMATE PACKAGE:</b> (Incls Eng Block Heater)
		<b>COOLING SYSTEM:</b> (Eng Oil Cooler comparable to KC4 is Std w/o GU6 Axle)
		KC4 Engine Oil (Incl w/Z82 Trailing)(N/AGT4 Axle)
		w/Z82
		w/o Z82
		KNP <b>Transmission, Heavy-Duty, Auxiliary</b> (Incl w/Z82 Trailing)
		w/Z82
		w/o Z82
		<b>EMISSIONS:</b> (Refer Emission Requirement Tab Section)
		FE9 Federal Emission Requirements
		YF5 California Emission Requirements
		NG1 New York/Massachusetts Emission Requirements
		NB8 California or New York/Massachusetts Emission Override (Reqs FE9 Federal Emissions)
		NC7 Federal Emission Override (Reqs YF5 California or NG1 New York/Massachusetts Emissions)
		<b>ENGINES:</b> (Refer Power Teams Chart)
		L31 Vortec 5700 V8 (350 Cu In)-SFI
		<b>GVWR:</b> (Must Specify One) (Refer GVWR Selector Chart for Availability)
		C5Q 6300#
		C5U 6800#
	x	AU0 <b>KEYLESS ENTRY:</b> Remote
		w/1SC
		w/1SB
		VK3 <b>LICENSE PLATE BRACKET:</b> Front
		<b>PAINT, EXTERIOR:</b> (Refer Color/Trim Charts for Availability)
		ZY1 Solid
		ZY2 Conventional Two-Tone
		<b>RADIO EQUIPMENT:</b>
	x	x ULO Electronically Tuned AM/FM Stereo Radio w/Seek-Scan, Digital Clock, Automatic Tone Control, Cassette Tape, Theft Lock and Speed Compensated Volume (Incls an Enhanced Performance Speaker System)
		UNO Electronically Tuned AM/FM Stereo Radio w/Seek-Scan, Digital Clock, Automatic Tone Control, Compact Disc Player, Theft Lock and Speed Compensated Volume (Incls an Enhanced Performance Speaker System)
		UPO Electronically Tuned AM/FM Stereo Radio w/Seek-Scan, Digital Clock, Automatic Tone Control, Stereo Cassette Tape w/Search and Repeat, Compact Disc Player, Theft Lock and Speed Compensated Volume (Incls an Enhanced Performance Speaker System)
		x AG9 <b>SEAT: Power Driver's Seat</b>
		w/1SC
		w/1SB
		<b>SEAT TYPE:</b> (Refer Color/Trim Chart for Availability)
	x	x AE7 Reclining 60/40 Split Bench Seat (Incls Storage Armrest and Power Lumbar)
		A95 Reclining High Back Bucket Seats (Incls Center and Roof Console and Power Lumbar)
		w/1SC
		w/1SB
		NZZ <b>SKID PLATE PACKAGE:</b> (K10706 Only)
		BVE <b>STEP RUNNING BOARD:</b> Side, Black (Supports 600 lbs) (Dealer Installed)
		<b>TIRES:</b> Tubeless (BW - Blackwall; WOL - White Outlined Letters; WL - White Letters)
		(Front, Rear and Spare)
		QFL P235/75R15 All Seasons Steel Belted Radial Ply B/W (K10706 Only)
		QFN P235/75R-15 All Seasons Steel Belted Radial Ply W/L (K10706 Only)
		QGA P245/75R16 All Terrain Steel Belted Radial Ply B/W (K10706 Only)
		QGB P245/75R16 All Terrain Steel Belted Radial Ply WOL (K10706 Only)
		V76 <b>TOW HOOKS:</b> (Std K1500)
		Z82 <b>TRAILERING SPECIAL EQUIPMENT:</b> Heavy-Duty (Incls Trailer Hitch Platform) (Incls KC4 Eng Oil Cooler and KNP Transmission Oil Cooler Where Available)
		v GT4
		w/GU6



**PAINT APPLICATIONS WITH ZY1 AND ZY2 PAINT**

SOLID PAINT - ZY1

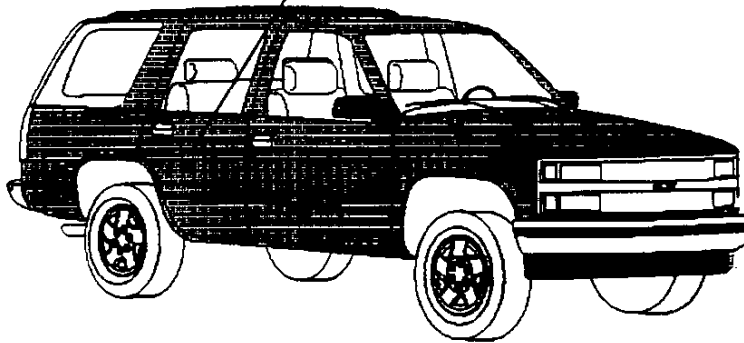

CONVENTIONAL TWO-TONE PAINT - ZY2

Color Code 1

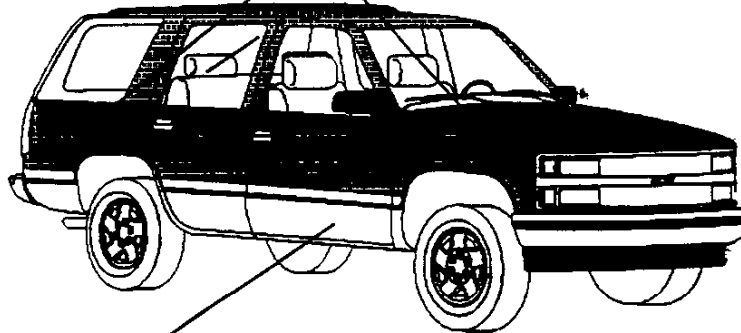

Color Code 2

## TAHOE 4-DOOR INTERIOR AND EXTERIOR COLOR AVAILABILITY CHART ZY1 PAINT

**PLEASE NOTE:** Below are the interior trim color and exterior paint combinations recommended by Chevrolet. They are the only available interior and exterior combinations allowed.

TRIM LEVEL (Must Specify Seat Option and Interior Color)	SEAT OPT	INTERIOR COLORS				
		Neutral	Blue	Gray	Red	
<b>LS PACKAGE</b>						
Custom Cloth Reclining Split Bench Seat	AE7	52D	26D	13D	79D	
Custom Cloth Reclining High Back Bucket Seats (Incls Roof/Floor Console)	A95	52D	26D	13D	79D	
<b>LT PACKAGE</b>						
* Custom Leather Reclining Split Bench Seats	AE7	522	262	132	792	
* Custom Leather Reclining High Back Bkt Seats	A95	522	262	132	792	
EXTERIOR COLORS w/ZY1 PAINT	Color Code 1	Paint Scheme	INTERIOR & EXTERIOR COMBINATIONS SHOWN ARE THE ONLY COMBINATIONS AVAILABLE			
^ BEIGE, MYSTIQUE MED (Met)	65U	ZY1	x		x	
BLACK, ONYX	41U	ZY1	x		x	x
BLUE, INDIGO (Met)	39U	ZY1	x	x	x	
GREEN, EMERALD (Met)	43U	ZY1	x		x	
QUICKSILVER (Met)	96U	ZY1		x	x	x
RED, CHERRY (Met)	77U	ZY1	x		x	x
CHERRY ICE (Met)	59U	ZY1	x		x	x
RED, VICTORY	74U	ZY1	x		x	x
WHITE, SUMMIT	50U	ZY1	x	x	x	x

\* Leather on Seating Surface Only

## INTERIOR AND EXTERIOR COLOR AVAILABILITY CHART ZY2 PAINT (Reqs LS/LT Decor)

EXTERIOR COLORS w/ZY2 PAINT	Color Code 1	**Color Code 2	Paint Scheme	INTERIOR & EXTERIOR COMBINATIONS SHOWN ARE THE ONLY COMBINATIONS AVAILABLE				WHEEL FLARE COLOR MOLDING
^ BEIGE, MYSTIQUE MED (Met)/Black Onyx (Met)	65U	41L	ZY2	x			x	Black, Onyx
BEIGE, MYSTIQUE MED (Met)/Red, Cherry (Met)	65U	77L	ZY2	x				Red, Cherry
^ BLACK, ONYX/Autumnwood, Lt (Met)	41U	55L	ZY2	x				Autumnwood
+ BLACK, ONYX/Beige, Mystique Med (Met)	41U	65L	ZY2	x				N/A
BLACK, ONYX/Quicksilver (Met)	41U	96L	ZY2			x	x	Silver
+ BLACK, ONYX/Red, Victory	41U	74L	ZY2			x		N/A
BLUE, INDIGO (Met)/Quicksilver (Met)	39U	96L	ZY2		x	x		Silver
^ CHERRY ICE (Met)/Autumnwood, Lt (Met)	59U	55L	ZY2	x			x	Autumnwood
CHERRY ICE (Met)/Quicksilver (Met)	59U	96L	ZY2			x	x	Quicksilver
CHERRY ICE (Met)/Red, Cherry (Met)	59U	77L	ZY2	x			x	Red, Cherry
^ GREEN, EMERALD (Met)/Autumnwood, Lt (Met)	43U	55L	ZY2	x				Autumnwood
+ GREEN, EMERALD (Met)/Beige, Mystique (Met)	43U	65L	ZY2	x				N/A
GREEN, EMERALD (Met)/Quicksilver (Met)	43U	96L	ZY2			x		Quicksilver
QUICKSILVER (Met)/Black, Onyx	96U	41L	ZY2			x	x	Black
QUICKSILVER (Met)/Blue, Indigo (Met)	96U	39L	ZY2		x	x		Blue, Indigo
+ QUICKSILVER (Met)/Cherry Ice (Met)	96U	59L	ZY2			x	x	N/A
^ QUICKSILVER (Met)/Red, Cherry (Met)	96U	77L	ZY2			x	x	Red, Cherry
+ RED, CHERRY (Met)/Beige, Mystique Med (Met)	77U	65L	ZY2	x			x	N/A
+ RED, CHERRY (Met)/Cherry Ice (Met)	77U	59L	ZY2	x			x	N/A
RED, CHERRY (Met)/Quicksilver (Met)	77U	96L	ZY2			x	x	Quicksilver
^ RED, VICTORY/Black, Onyx (Met)	74U	41L	ZY2			x	x	Black, Onyx
^ RED, VICTORY/Quicksilver (Met)	74U	96L	ZY2			x	x	Quicksilver
^ WHITE, SUMMIT/Autumnwood, Lt (Met)	50U	55L	ZY2	x				Autumnwood
+ WHITE, SUMMIT/Beige, Mystique Med (Met)	50U	65L	ZY2	x				N/A
WHITE, SUMMIT/Blue Indigo (Met)	50U	39L	ZY2		x			Blue, Indigo
+ WHITE, SUMMIT/Cherry Ice (Met)	50U	59L	ZY2	x		x	x	N/A
^ WHITE, SUMMIT/Red, Cherry (Met)	50U	77L	ZY2	x			x	Red, Cherry

+ N/A B71 Molding or K10906 w/L65 Eng or on K20906  
\* Color Code 2 Must be ordered as a (+) Plus Option

REVISED: 12-16-96

1997 ORDER GUIDE

^ Indicates Change

TAHOE

Page 17

Prices Shown Are Manufacturer's Suggested Retail Prices (MSRP) At The Time Of Publication. These Prices Are To Be Used Only As An Aid To Inventory Management Since MSRP Figures Change Periodically. The Vehicle Price Schedule Is The Official Pricing Documentation Of Chevrolet Motor Division And Should Be Used In Discussing Vehicle Prices With Potential Buyers. The Model Prices Shown In The Order Guide Include The Destination Freight Charges.

---

**NOTES**

## TAHOE 4-DOOR INTERIOR AND EXTERIOR COLOR AVAILABILITY CHART ZY1 PAINT

**PLEASE NOTE:** Below are the interior trim color and exterior paint combinations recommended by Chevrolet. They are the only available interior and exterior combinations allowed.

TRIM LEVEL (Must Specify Seat Option and Interior Color)	SEAT OPT	INTERIOR COLORS				
		Neutral	Blue	Gray	Red	
<b>LS PACKAGE</b>						
Custom Cloth Reclining Split Bench Seat	AE7	52D	26D	13D	79D	
Custom Cloth Reclining High Back Bucket Seats (Incls Roof/Floor Console)	A95	52D	26D	13D	79D	
<b>LT PACKAGE</b>						
*Custom Leather Reclining Split Bench Seats	AE7	522	262	132	792	
*Custom Leather Reclining High Back Bkt Seats	A95	522	262	132	792	
EXTERIOR COLORS w/ZY1 PAINT	Color Code 1	Paint Scheme	INTERIOR & EXTERIOR COMBINATIONS SHOWN ARE THE ONLY COMBINATIONS AVAILABLE			
BEIGE, MYSTIQUE MED (Met)	65U	ZY1	x			
BLACK, ONYX	41U	ZY1	x		x	x
BLUE, INDIGO (Met)	39U	ZY1	x	x	x	
BLUE, OPAL MED (Met) <i>Oct 78 - auto products</i>	24U	ZY1	x	x	x	
GREEN, EMERALD (Met)	43U	ZY1	x		x	
QUICKSILVER (Met)	96U	ZY1		x	x	x
RED, CHERRY (Met)	77U	ZY1	x		x	x
CHERRY ICE (Met)	59U	ZY1	x		x	x
RED, VICTORY	74U	ZY1	x		x	
WHITE, SUMMIT	50U	ZY1	x	x	x	x

\* Leather on Seating Surfaces Only

## INTERIOR AND EXTERIOR COLOR AVAILABILITY CHART ZY2 PAINT (Reqs LS/LT Decor)

EXTERIOR COLORS w/ZY2 PAINT	Color Code 1	**Color Code 2	Paint Scheme	INTERIOR & EXTERIOR COMBINATIONS SHOWN ARE THE ONLY COMBINATIONS AVAILABLE			
BEIGE, MYSTIQUE MED (Met)/Black, Onyx	65U	41L	ZY2	x			
BEIGE, MYSTIQUE MED (Met)/Red, Cherry (Met)	65U	77L	ZY2	x			x
BLACK, ONYX/Quicksilver (Met)	41U	96L	ZY2			x	x
BLACK, ONYX/Red, Victory	41U	74L	ZY2			x	
BLUE, INDIGO (Met)/Blue, Opal Med (Met)	39U	24L	ZY2		x	x	
BLUE, INDIGO (Met)/Quicksilver (Met)	39U	96L	ZY2		x	x	
BLUE, OPAL MED (Met)/Blue, Indigo (Met)	24U	39L	ZY2		x	x	
BLUE, OPAL MED (Met)/Quicksilver (Met)	24U	96L	ZY2		x	x	
CHERRY ICE (Met)/Quicksilver (Met)	59U	96L	ZY2			x	x
CHERRY ICE (Met)/Red, Cherry (Met)	59U	77L	ZY2	x		x	x
GREEN, EMERALD (Met)/Quicksilver (Met)	43U	96L	ZY2			x	
QUICKSILVER (Met)/Black, Onyx	96U	41L	ZY2			x	x
QUICKSILVER (Met)/Blue, Indigo (Met)	96U	39L	ZY2			x	
QUICKSILVER (Met)/Blue, Opal Med (Met)	96U	24L	ZY2		x	x	
QUICKSILVER (Met)/Cherry Ice (Met)	96U	59L	ZY2			x	x
QUICKSILVER (Met)/Red, Cherry (Met)	96U	77L	ZY2			x	x
RED, CHERRY (Met)/Beige, Mystique Med (Met)	77U	65L	ZY2	x			
RED, CHERRY (Met)/Cherry Ice (Met)	77U	59L	ZY2	x		x	x
RED, CHERRY (Met)/Quicksilver (Met)	77U	96L	ZY2			x	x
RED, VICTORY/Quicksilver (Met)	74U	96L	ZY2			x	
WHITE, SUMMIT/Blue Indigo (Met)	50U	39L	ZY2		x		
WHITE, SUMMIT/Blue, Opal Med (Met)	50U	24L	ZY2	x	x		
WHITE, SUMMIT/Cherry Ice (Met)	50U	59L	ZY2	x		x	x
WHITE, SUMMIT/Red, Cherry (Met)	50U	77L	ZY2				x

\* Color Code 2 Must be ordered as a (+) Plus option

REVISED: 8-19-96

1997 ORDER GUIDE

TAHOE  
Page 17

Prices Shown Are Manufacturer's Suggested Retail Prices (MSRP) At The Time Of Publication. These Prices Are To Be Used Only As An Aid To Inventory Management Since MSRP Figures Change Periodically. The Vehicle Price Schedule Is The Official Pricing Documentation Of Chevrolet Motor Division And Should Be Used In Discussing Vehicle Prices With Potential Buyers. The Model Prices Shown In The Order Guide Include The Destination Freight Charges.

# NOTES

# TAHOE INTRODUCTION

## TAHOE

The 1997 Tahoe is available in three trim levels: "Standard" and a choice of two uplevel trims, "LS" and "LT."

Changes on the Tahoe for 1997 include:

- New Rear Door Lock Switch. Provides a rear door lock/unlock switch that can be operated from the rear while doors are open
  - New Electronic Variable Orifice (E.V.O.) Steering. Reduces low speed and static steering effort
  - Revised Keyless Entry System
  - New Passenger Side Air Bag
  - Improved Turn Radius (K 1500 Series)
  - DEX-COOL™ Extended Life Engine Coolant Change interval upgraded to 5 years/150,000 miles
  - 4-speed 4L60-E Automatic Transmission Enhancements (M30)
  - 4-speed 4L80-E Automatic Transmission Enhancements (MT1)
  - Two New Exterior Colors
  - New Second Row Seatbelt Child Comfort Guides
-

## MODEL SELECTION SUMMARY

Use the chart below to choose the model that fits your customer's needs. Please note that the Base Payloads shown reflect the maximum allowable weight of cargo that can be carried in a standard model, including occupants. (They are calculated by subtracting curb weight from GVWR.) To calculate payloads for models with optional equipment, please refer to the WEIGHTS section in the back of this book or consult your 1997 GM PROSPEC. Also, the Maximum Trailer Weights shown below are based on vehicles that are properly equipped. See your Chevrolet Truck Order Guide for specific details.

SERIES	MODEL NUMBER/ BODY CODE/ OPTION CODE	PASSENGER CAPACITY (STD./OPT.)	STANDARD ENGINE/ TRANS.	OPTIONAL ENGINE/ TRANS.	GVWR (LB)	GAWR (LB) FRONT/ REAR	BASE PAYLOAD (LB)	MAXIMUM TRAILER WT./ TONGUE LOAD (LB) PROPERLY EQUIPPED
<b>TWO-WHEEL-DRIVE MODELS</b>								
2-DOOR TAHOE	CC10516/ZW9/E55	5/6	5700 V8/A4	—	6100	3200/3686	1586	6000/750
4-DOOR TAHOE	CC10706/ZW9/E55	6/5	5700 V8/A4	—	6300	3200/3686	1435	7000/850
<b>FOUR-WHEEL-DRIVE MODELS</b>								
2-DOOR TAHOE	CK10516/ZW9/E55	5/6	5700 V8/A4	—	6250	3925/3750	1392	6500/800
2-DOOR TAHOE	CK10516/ZW9/E55	5/6	6.5L V8 <sup>1</sup> /A4	—	6450	3925/3750	*	7000/850
4-DOOR TAHOE	CK10706/ZW9/E55	6/5	5700 V8/A4	—	6800	3600/3750	1532	6500/800

<sup>1</sup>Turbo Diesel(L56)

\* Please refer to the Weights section at the back of the Tech Guide to determine optional payloads.

## POWERTRAINS

Chevrolet offers a variety of engines, transmissions and axle ratios for the Tahoe. The following charts detail basic engine, transmission and axle specifications. See your 1997 Chevrolet Truck Order Guide for specific details.

<b>ENGINES</b>		
	<b>VORTEC 5700 V8</b>	<b>6.5L V8 TURBO DIESEL</b>
Engine Order Code	L31	L56
SAE Net Horsepower @ rpm	255 @ 4600	180 @ 3400
SAE Net Torque lb-ft @ rpm	330 @ 2800	360 @ 1800
Fuel System	SFI	Indirect Fuel Injection
Standard Battery Cold Cranking Amps @ 0° F	600	2 @ 600 each
Standard Alternator Max. Cap. (Amps)	100	100

<b>TRANSMISSIONS</b>		
	<b>ELECTRONIC AUTOMATIC 4-SPEED WITH OVERDRIVE AND TORQUE CONVERTER CLUTCH (4L60-E)</b>	<b>ELECTRONICALLY CONTROLLED AUTOMATIC 4-SPEED W/OVERDRIVE TORQUE CONVERTER CLUTCH HD (4L80-E)</b>
Transmission Order Code	M30	MT1
Engine Application (Order Code)	VORTEC 5700 V8 (L31)	6.5L V8 Turbo Diesel (L56)
Gear Ratios		
First	3.06	2.48
Second	1.63	1.48
Third	1.00	1.00
Fourth	0.70	0.75
Fifth	—	—
Reverse	2.29	2.08

# TAHOE

AXLES						
	REAR AXLE			FRONT AXLE (4X4 ONLY)		
Make	American Axle					
Capacity (lb)	3750			3925		
Pinion and Ring Gear Type	Hypoid			Hypoid		
Axle Ratio Code	GU4	GU6	GT4 <sup>1</sup>	GU6	GT4	
Ratio	3.08	3.42	3.73	3.42	3.73	
Pinion Teeth	13	12	11	12	11	
Ring Gear Teeth	40	41	41	41	41	
Ring Gear Diameter (in.)	8.6	8.6	8.6	8.25	8.25	

Note: Axle Ratio availability depends on model, powertrain and emissions selected.  
<sup>1</sup>GT4 N/A with CC10516.

## TRIM LEVELS

Chevrolet offers the 2-door Tahoe in three trim levels: "Standard" and a choice of two uplevel trims "LS" and "LT". The 4-door Tahoe models are available in LS/LT only. The following chart details major standard features. See your 1997 Chevrolet Truck Order Guide for details.

CHASSIS EQUIPMENT		STANDARD	LS/LT (YE9)
<b>KEY:</b> ■ = STANDARD, — = NOT INCLUDED			
<b>BRAKES</b>	Power-assisted; front disc, rear drum with four-wheel anti-lock system. Includes brake/transmission shift interlock.	■	■
<b>EXHAUST</b>	Single. Aluminized stainless steel.	■	■
<b>FRAME</b>	All-welded ladder type, channel design and boxed front-end section. Section Modulus: 4.29 cu in.	■	■
<b>FUEL TANK</b>	30.0-gallon (approx.) capacity.	■	■
<b>REAR AXLE</b>	Hypoid semi-floating.	■	■
<b>SHOCK ABSORBERS</b>	32mm - 2-door models front and rear; 36mm - 4-door models front and rear.	■	■
<b>STABILIZER BAR, FRONT</b>	1.18 inches on K10516 and K10706. 1.26 inches on C10706 and C10516.	■	■
<b>STABILIZER BAR, REAR</b>	.87 inch (K10706 only).	—	■
<b>STEERING</b>	Integral power. Speed Sensitive (E.V.O.)	■	■
<b>SUSPENSION, FRONT</b>	2WD: Independent with coil springs. 4WD: Independent with torsion bars.	■	■
<b>SUSPENSION, REAR</b>	Semi-elliptic two-stage multileaf springs.	■	■
<b>TOW HOOKS</b>	Two front-mounted on 4x4 only.	■	■

EXTERIOR EQUIPMENT		STANDARD	LS/LT (YE9)
<b>AIR DAM</b>	Dark argent.	■	■
<b>BUMPER, FRONT</b>	Bright appearance with black rub strip and bright trim.	■	■
<b>BUMPER, REAR</b>	Bright appearance with black rub strip and step pad.	■	■
<b>DOORS, REAR</b>	Panel type.	■	■
<b>GLASS</b>	Tinted Solar-Ray®. Deep-tint glass included.	—	■
<b>GRILLE</b>	Molded plastic painted argent with argent air-intake areas. Deluxe front appearance package with bright grille and trim, and bright air-intake areas.	■	—
<b>HEADLAMPS</b>	Single rectangular halogen. Composite halogen.	■	■
<b>HORN</b>	Single-electric note. Dual low-and high-note.	—	■
<b>INSULATION</b>	Hood and cab-to-fender.	—	■
<b>LAMPS</b>	Center high-mounted stop lamp. Underhood (Fixed).	■	■
<b>LUGGAGE CARRIER</b>	Black, roof-mounted.	—	■
<b>MIRRORS</b>	RH and LH below-eyeline type, painted black with adjustable heads. Head size 8.5" x 5.0". RH and LH electric below-eyeline, outside rearview, black. Headsize 8.5" x 5.0".	■	—
<b>MOLDINGS</b>	Black bodyside with bright trim and bright wheel opening.	■	■
<b>RUNNING LAMPS</b>	Daytime.	■	■
<b>TIRES</b>	Five steel-belted radial blackwall. Size and type vary by model. C10516: P235/75R15 K10516: P245/75R16 C10706: P235/75R15 K10706: P245/75R16	■	■



## EXTERIOR EQUIPMENT (CONT.)

KEY: ■ = STANDARD, — = NOT INCLUDED		STANDARD	LS/LT (YE9)
<b>WHEELS</b>	C10516: Five <del>silver</del> painted 15.0" x 7.0" steel wheels with black hub ornament. C10516: Four <del>cast</del> aluminum 15.0" x 7.0" wheels with steel spare wheel. K10516: Five <del>silver</del> painted 16.0" x 6.5" steel wheels with black hub ornament. K10516: Four <del>cast</del> aluminum 16.0" x 7.0" wheels with steel spare wheel. C10706: Four <del>15.0"</del> x 7.0" cast aluminum with steel spare wheel. K10706: Four <del>16.0"</del> x 7.0" cast aluminum with steel spare wheel.	■ — ■ ■ — —	— ■ — ■ ■ ■
<b>WIRING</b>	Eight-wire <del>harness</del> for trailering purposes (includes CHMSL).	■	■

## INTERIOR EQUIPMENT

<b>AIR BAG*</b>	Driver's side <del>air bag</del> and Passenger side air bag.	■	■
<b>AIR CONDITIONING</b>	Front.	—	■
<b>ARMRESTS</b>	RH and LH <del>padding</del> , integral with door panels.	■	■
<b>ASSIST HANDLES</b>	2-door <del>model</del> <del>RH</del> front, one "A" pillar mounted, one roofed mounted; two in second seat <del>area</del> , LH/RH roof mounted. 4-door <del>model</del> <del>RH</del> front seat - one roof mounted, one "A" pillar-mounted. <del>RH/LH</del> rear seats - two roof mounted, two "B" pillar-mounted.	■ — —	■ ■ ■
<b>CARGO NET</b>	Removable <del>security</del> net located in rear compartment.	—	■
<b>CARGO SECURITY SHADE</b>	Color-keyed, <del>removable</del> security shade on 4-door models. Extends from rear seat to endgate.	—	■
<b>CIGARETTE LIGHTER</b>	Located on <del>instrument</del> panel. Includes ashtray light and two covered auxiliary power outlets.	■	■
<b>CUPHOLDERS</b>	Two located in <del>the</del> dash and two located in tray on top of dash. Two located in <del>the</del> rear seat center armrest (4-door models only).	■ —	■ ■
<b>DOOR PANELS</b>	Color-keyed <del>resin</del> plastic. Soft vinyl <del>color-keyed</del> door panel with cloth inserts, armrests and map pockets with carpet trim. <del>Also</del> includes door reflectors with lights. NOTE: Scotchgard™ Fabric Protector on all cloth seats and door trim panels.	■ —	— ■
<b>DOOR LOCKS</b>	Power, <del>also</del> includes rear door lock switch. (LT includes remote keyless entry.)	■	■
<b>DOORS</b>	Side-door <del>guard</del> beams.	■	■
<b>DRIVER'S CONVENIENCE GROUP</b>	Speed <del>Control</del> , <del>Tilt</del> -Wheel™.	—	■
<b>FLOOR COVERING</b>	Black <del>embossed</del> vinyl mat. Color-keyed <del>carpet</del> with Scotchgard™ Fabric Protector and removable color-keyed vinyl floor mats.	■ —	— ■
<b>GAGES</b>	Include <del>speedometer</del> , odometer, trip odometer, fuel level, voltmeter, engine temperature, <del>oil</del> pressure additional telltale lights and tachometer.	■	■
<b>GLOVE BOX</b>	Latched <del>door</del> with light.	■	■
<b>HEADLINER</b>	Color-keyed <del>cloth</del> and matching retainer moldings.	■	■
<b>HEADLAMP WARNING TONE</b>	Headlamps <del>on</del> .	■	■
<b>HEATER</b>	Front <del>heater</del> with windshield and front side defoggers. Rear <del>defogger</del> .	■ —	■ ■
<b>HEATER DUCT</b>	Rear <del>seat area</del> . Located on floor under front seats.	■	■
<b>INSULATION</b>	Provided on <del>dash</del> panel, cowl top and sides, headliner and doors. Additional <del>insulation</del> on headliner and side panel.	■ —	■ ■
<b>LIGHTING</b>	Includes <del>dome</del> , reading, ashtray, glove box and cargo lamps. Front and <del>rear</del> dome lamps with switches in RH and LH door jambs and front and rear map lamps. <del>Dome</del> lamp includes delayed illuminated entry feature. All door- <del>actuated</del> dome lamps (including rear lift glass or panel door jamb switch) and front and <del>rear</del> reading lamps on 4-door models.	■ ■ —	■ ■ ■
<b>MIRRORS</b>	10-inch <del>rearview</del> . 10-inch <del>electrochromic</del> rearview with 8-point compass.	■ —	— ■
<b>RADIOS</b>	ETR AM/FM <del>stereo</del> radio with Seek-Scan and digital clock. Includes two 6" diam. front door <del>speakers</del> and two 4" x 10" rear speakers mounted in the rear headliner (4 speakers in all). ETR AM/FM <del>stereo</del> radio with Seek-Scan with automatic tone control, digital clock, cassette deck, TheftLock™ and speed-compensated volume. Includes two front 6" diam. door <del>speakers</del> , two .6" tweeters located in power switch pad forward of armrest, and two rear 4" x 10" <del>speakers</del> mounted in the rear headliner (6 speakers in all on C/K10516). Includes two <del>additional</del> speakers in rear side doors on C/K10706 (8 speakers in all).	■ —	— ■
<b>REAR QUARTER TRIM PANELS</b>	Black fabric. Color-keyed, <del>carpeted</del> , with cupholder, storage space and ashtrays on 2-door models. 4-door <del>models</del> include storage bin located at left rear quarter panel. NOTE: Scotchgard™ Fabric Protector on all cloth seats and trim panels.	■ —	— ■
<b>RELEASE, ELECTRIC LIFT GLASS</b>	Located on <del>instrument</del> panel (w/E55 body).	■	■
<b>SEATS<sup>1</sup></b>	2-Door: Two <del>vinyl</del> reclining buckets with head restraints and easy-entry feature with memory and 3-passenger folding rear bench seat. 3-passenger custom cloth 60/40 reclining front split bench seat with center armrest, adjustable outboard headrests, power lumbar support, seat-back storage nets and easy-entry feature with memory. Front center armrest provides lift-up storage space that features a coin holder, a map strap on the inside lid and a writing board. 3-passenger folding rear bench with head restraints and child comfort guides. LT trim features power driver's seat and leather seating surfaces.	■ —	— ■

\* Always wear your safety belts. <sup>1</sup> Seatbelts are adjustable on front seats only on 2-door models.

# TAHOE

INTERIOR EQUIPMENT (CONT.)		STANDARD	LS/LT (YE9)
<b>KEY: ■ = STANDARD, — = NOT INCLUDED</b>			
<b>SEATS</b>	4-Door: 3-passenger custom cloth 60/40 reclining split bench front seat with center armrest, adjustable outboard headrests, power lumbar support and seat-back storage nets. Front center armrest provides lift-up storage space that features a coin holder, a map strap on the inside lid and a writing board. Matching 3-passenger split bench rear seat with center armrest with two cupholders and tissue box holder. Seat-backs have flipper panels. Seats on 4-door models also include adjustable shoulder belts with child comfort guides. LT trim features leather seating surfaces. NOTE: Scotchgard™ Fabric Protector on all cloth seats and trim panels.	—	■
<b>SPARE TIRE CARRIER</b>	Located on inside LH rear panel on 2-door model only. Includes color-keyed cloth wheel cover on 2-door model only.	■	■
<b>SPARE TIRE/WHEEL</b>	Full size, mounted inside on 2-door model and under body at rear on 4-door models. (YE9 includes steel spare).	—	■
<b>STEERING WHEEL</b>	Simulated leather. Leather.	■	—
<b>SUNSHADES</b>	Color-keyed cloth RH and LH, padded with storage strap on LH unit and visor mirror on RH unit. Color-keyed RH and LH padded with cloth covering, extenders, and illuminated visor mirrors. Storage strap on LH unit.	■	—
<b>TOOLS</b>	Mechanical jack and wheel wrench (gloves included with YE9).	■	■
<b>WINDOWS</b>	Power. Driver has express down feature.	■	■
<b>WINDSHIELD WIPERS</b>	Intermittent. Rear wiper/washer (with YE9 and E55).	■	■

## PREFERRED EQUIPMENT GROUPS

Preferred Equipment Groups (PEGs) are convenient option packages that can save your customers money. They would pay appreciably more by buying all the options in a Preferred Equipment Group as individual options. (Savings based on a comparison of Manufacturer's Suggested Retail Price of option packages vs. MSRP of individual options purchased separately.) See your 1997 Chevrolet Truck Order Guide and Vehicle Price Schedule for specific information and prices.

## OPTIONS

These options can be ordered individually in addition to the Preferred Equipment Groups if not already included. See your 1997 Chevrolet Truck Order Guide for specific availability and restrictions. The Option Code is listed in **bold type**.

Air Cleaner, High Capacity (N/A Diesel Engine) .....	<b>K47</b>	Glass, Solar-Ray® Deep-Tinted .....	<b>AJ1</b>	Rear Window Equipment Wiper/Washer System with Defogger (requires E55 body) .....	<b>ZP6</b>
Air Conditioning .....	<b>C60</b>	GVWR Ratings .....	<b>C5M</b>	Step Running Boards, Side, Black (dealer installed) .....	<b>BVE</b>
Axles, Rear		6100 lb .....	<b>C5P</b>	Seats	
3.08 .....	<b>GU4</b>	6250 lb .....	<b>C5Q</b>	Seat Adjuster, Power (driver's side only) ..	<b>AG9</b>
3.42 .....	<b>GU6</b>	6300 lb .....	<b>C71</b>	60/40 Reclining Split Bench Seat .....	<b>AE7</b>
3.73 .....	<b>GT4</b>	6450 lb .....	<b>C5U</b>	Reclining High-Back Bucket Seats (includes center and roof console) .....	<b>A95</b>
Rear Locking Differential .....	<b>G80</b>	6800 lb .....	<b>AU0</b>	Skid Plate Package (includes shield plates for front differential, transfer case. A fuel tank skid plate is also included on K10516 only) .....	<b>NZZ</b>
Body, Tailgate (drop-gate tailgate with lift-glass and electric tailgate release) .....	<b>E55</b>	Keyless Entry, Remote (Req. YE9) .....	<b>VK3</b>	Sport Appearance Package (includes Conventional Two-Tone Paint and Wheel Flare Moldings) (N/A on 4-door models or C10516) .....	<b>BYP</b>
Chassis Equipment Off-Road Package (includes front and rear 46 mm high-pressure gas shocks and NZZ Shield Package) (Reqs YE9) (available K10516 only) .....	<b>Z71</b>	License Plate Bracket Front .....	<b>DF2</b>	Springs (Torsion Bars req. K10516), Front, Heavy-Duty (N/A on 4-door models) .....	<b>F60</b>
Cold Climate Package (includes Engine Block Heater) .....	<b>V10</b>	Mirrors, Camper Type (LH and RH stainless steel) (N/A on 4-door models) ....	<b>B71</b>	Tow Hooks (2WD models only) .....	<b>V76</b>
Convenience Package, Driver's (includes Tilt-Wheel™ and Electronic Speed Control) .....	<b>ZQ3</b>	Moldings, Wheel Opening Flare (front and rear) (N/A on 4-door models) ....	<b>ZY1</b>	Trailing Package, Heavy-Duty (includes hitch platform) .....	<b>Z82</b>
Cooling: Engine Oil Cooler .....	<b>KC4</b>	Paint, Exterior Solid .....	<b>ZY2</b>	Transfer Case, Electronic Shift Control .....	<b>NP1</b>
Cooling: Heavy Duty Transmission (included w/MT1) .....	<b>KNP</b>	Conventional Two-Tone (Req. YE9) .....	<b>UL5</b>	Transmissions	
Defogger, Rear Window (Req. ZW9 and C60 A/C) .....	<b>C49</b>	Radio Equipment	<b>UM6</b>	Electronic 4-speed Automatic w/Overdrive .....	<b>M30</b>
Emissions		Radio Delete .....	<b>UNO</b>	Electronically Controlled 4-speed Automatic w/Overdrive (K10516 w/L65 only) .....	<b>MT1</b>
Federal .....	<b>FE9</b>	ETR AM/FM Stereo Radio .....	<b>UPO</b>	Wheels, Rally Trim .....	<b>PO6</b>
California .....	<b>YF5</b>	w/Seek-Scan, Stereo Cassette, Digital Clock .....		Wheels, Cast Aluminum (4WD) .....	<b>PF4</b>
Massachusetts/New York .....	<b>NG1</b>	ETR AM/FM Stereo Radio with Seek- Scan, Automatic Tone Control, Compact Disc Player, Digital Clock, Theft Lock™ and Speed-Compensated Volume (includes an enhanced performance speaker system) (Req. YE9) .....		Wheels, Cast Aluminum (2WD) .....	<b>N90</b>
Federal Emissions Override .....	<b>NC7</b>	Compact Disc Player, Cassette Deck, Digital Clock, Theft Lock™ and Speed- Compensated Volume (includes an enhanced performance speaker system) (Req. YE9) .....			
Cal./Mass./N.Y. Emissions Override .....	<b>NB8</b>				
Engine					
VORTEC 5700 SFI V8 .....	<b>L31</b>				
6.5L V8 Turbo Diesel (K10516 only) .....	<b>L56</b>				

## TIRES

**KEY: ALS = ALL-SEASON SBR = STEEL-BELTED RADIAL PLY BW = BLACKWALL WOL = WHITE OUTLINE LETTERED  
 OOR = ON-OFF ROAD ALT = ALL TERRAIN**

TIRE DESCRIPTION		ORDER CODE
P235/75R15	ALS/WL/SBR	QFN
P235/75R15	ALS/SBR/BW	QFL
LT245/75R16C	OOB/SBR/WOL	QBX
LT245/75R16C	OOB/SBR/BW	QBN
P245/75R16	ALT/SBR/BW	QGA
P245/75R16	ALT/SBR/WOL	QGB
P265/75R16	ALT/SBR/BW	QGC
P265/75R16	ALT/SBR/WOL	QGD

## DIMENSIONS

MODEL		TAHOE			
MODEL NUMBER		CC10516	CC10706	CK10516	CK10706
<b>EXTERIOR DIMENSIONS</b>					
<b>BODY</b>					
Wheelbase (in.)	L101	111.5	117.5	111.5	117.5
Overall Length (in.)	L103	188.0	199.6	188.0	199.6
Overall Height (in.)	H431	71.4	72.8	73.0	75.0
Maximum Width (in.)	W103	77.1	76.8	77.1	76.8
Bumper to Axle (in.)					
Front	L104	35.4	35.8	35.4	35.8
Rear	L105	41.1	46.2	41.1	46.2
Ground to Top of Rear Load Floor (in.)	H502	29.3	29.2	30.6	30.5
Ground Clearance (in.)					
Front/Rear	H148/H153	7.3/7.2	10.5/7.2	9.9/8.0	9.6/8.6
Turning Diameter Curb-to-Curb (ft)		38.1	39.8	39.0	40.7
Track Width (in.) Front/Rear	W101/102	63.6/63.6	63.6/64.6	64.1/63.5	62.6/63.6
<b>SIGN PANEL AREA (in.)</b>		17 x 48.75	17 x 76.50	17 x 48.75	17 x 76.50

## INTERIOR DIMENSIONS

Headroom (in.)					
Front/Rear	H61/H63	39.9/37.8	39.9/38.9	39.9/37.8	39.9/38.9
Legroom (in.)					
Front/Rear	L34/L51	41.7/36.4	41.7/36.4	41.7/36.4	41.7/36.4
Shoulder Room (in.)					
Front/Rear	W3/W4	65.4/66.0	64.7/64.8	65.4/66.0	64.7/64.8
Hip Room (in.)					
Front/Rear	W5/W6	60.0/60.7	59.9/59.7	60.0/60.7	59.9/59.7
Cargo Volume (cu ft)					
Behind Rear Seat <sup>1</sup>		51.6	66.9	51.6	66.9
Behind Front Seat		99.4	118.2	99.4	118.2
Load Floor Length (in.)					
Behind Rear Seat	L203	38.8	52.2	38.8	52.2
Behind Front Seat	L202	74.6	77.8	74.6	77.8
Interior Width Between Wheelhousings (in.)	W201	49.7	49.4	49.7	49.4
Cargo Area Width Front	W200	62.8	63.2	62.8	63.2
Cargo Area Height (in.)	H201	39.7	40.8	39.7	40.8

<sup>1</sup>Measured floor to roof.

# SUBURBAN INTRODUCTION

## SUBURBAN

The 1997 Suburban is available in three trim levels: "Standard" and a choice of two uplevel trims; "LS" and "LT."

Changes on the Suburban for 1997 include:

- New Rear Door Lock switch. Provides a rear door lock/unlock capability that can be operated from the rear while doors are open
  - New Passenger Side Air Bag
  - New Second Seat Shoulder Belt Height Adjuster with Child Comfort Guides
  - New Electronic Variable Orifice (E.V.O.) Steering Reduces low speed and static steering effort
  - 4-speed 4L60-E Automatic Transmission Enhancements (M30)
  - 4-speed 4L80-E Automatic Transmission Enhancements (MT1)
  - Revised Keyless Entry System
  - Two New Exterior Colors
  - Improved Turn Radius (4WD models)
  - DEX-COOL™ Extended Life Engine Coolant Change interval upgraded to 5 years/150,000 miles
-

10

11

12

13

## HEATER, VENTILATION, AND AIR CONDITIONING 1B-7

RELATIVE HUMIDITY	AMBIENT AIR TEMP		MAXIMUM LOW SIDE PRESSURE		ENGINE SPEED (rpm)	MAXIMUM RIGHT CENTER AIR OUTLET TEMP		MAXIMUM HIGH SIDE PRESSURE	
	(%)	°F	°C	PSIG		kPaG	°F	°C	PSIG
20	70	21	24	165	2000	44	7	285	1965
	80	27	25	172		45	7	290	2000
	90	32	28	193		49	9	314	2165
	100	38	28	193		50	10	320	2206
30	70	21	25	172	2000	43	6	287	1979
	80	27	26	179		45	7	293	2020
	90	32	28	193		50	9	320	2206
	100	38	31	214		53	12	328	2262
40	70	21	25	172	2000	45	7	290	2000
	80	27	28	193		49	9	315	2172
	90	32	28	193		51	11	325	2241
	100	38	37	255		59	15	361	2489
50	70	21	26	179	2000	45	7	290	2000
	80	27	28	193		50	10	320	2206
	90	32	32	221		54	12	330	2275
	100	38	40	276		64	18	370	2551
60	70	21	27	186	2000	46	8	300	2069
	80	27	28	193		50	10	320	2206
	90	32	36	248		58	14	355	2448
	100	38	45	310		68	20	409	2820
70	70	21	28	193	2000	49	9	315	2172
	80	27	28	193		51	11	325	2241
	90	32	38	262		62	17	363	2503
80	70	21	28	193	2000	50	10	320	2206
	80	27	32	221		54	12	330	2275
	90	32	41	283		65	18	377	2600

T3204

Figure 4—System Performance Test

A/C

1

2

3

4

5

6

EXTERIOR LAMPS

7-WIRE TRAILING HARNESS

HOT AT ALL TIMES

WIRE LEADS ARE TO BE SPLICED TO TRAILER WIRING HARNESS OR ATTACHED TO TRAILER WIRE PLUG.

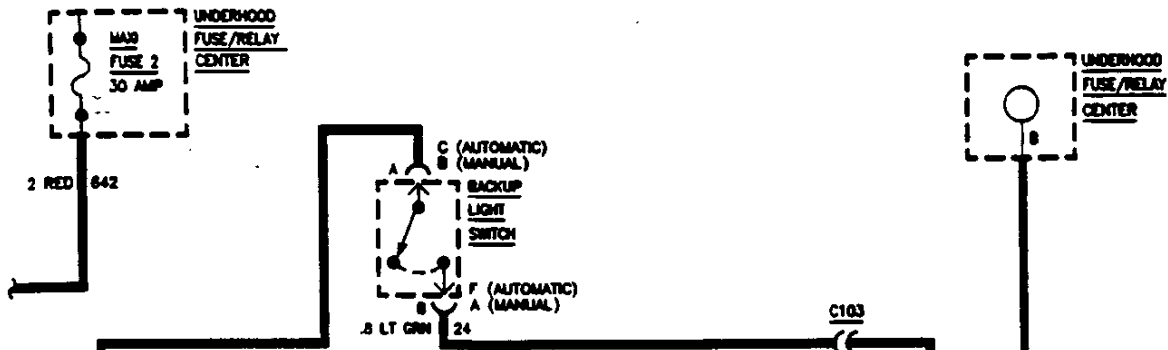

GAGE/COLOR	PURPOSE
5 WHT	TRAILER GROUND
.8 BRN	TAL AND LICENSE LAMPS
.8 YEL	LH TURN/HAZARD STOPLAMPS
.8 DK GRN	RH TURN/HAZARD STOPLAMPS
5 RED	BATTERY POWER
3 DK BLU	AUXILIARY LEAD

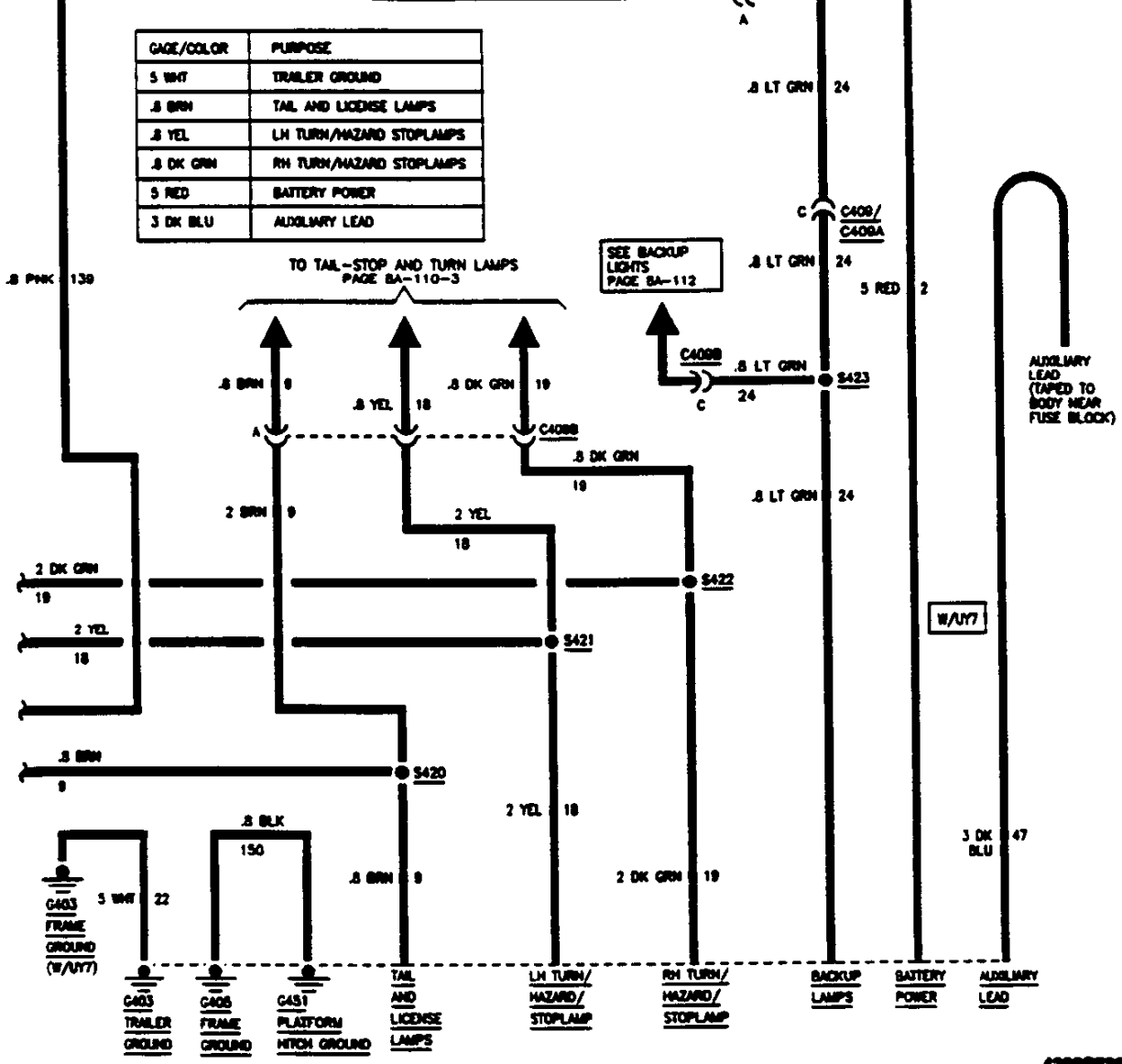

TO TAIL-STOP AND TURN LAMPS  
PAGE BA-110-3

SEE BACKUP LIGHTS  
PAGE BA-112

AUXILIARY LEAD  
(TAPED TO BODY NEAR FUSE BLOCK)

W/U77





1

