

1990
CHEVROLET
GEO PRIZM



1990 GEO PRIZM

GENERAL		ENGINE	STD	OPT	PERFORMANCE	
Base Price	\$9,660	Type	L4 DOHC	N/A	Manual	Auto
Vehicle Type	4-Door Sedan and Hatchback	Block Material	Cast Iron		27/33	24/28
Vehicle Class	Subcompact	Cylinder Head Material/ Configuration/ Hydraulic Lifters (yes/no)	Aluminum Alloy, 4 valves per cyl/ no			N/A
Primary Structure	Unit Body	Bore x Stroke	3.2 x 3.0 in. (81.0 x 77.0mm) In-line, 4			N/A
Body Material	High Strength Steel	Arrangement and No. Cylinders				N/A
SUSPENSION		Displacement	1.6L/98CID		CAPACITIES/CALCULATED DATA	
Front	Independent, MacPherson Struts, Coil Springs	Compression Ratio	9.5:1		Engine Oil	Sedan 3.2 qt.
Rear	Independent, MacPherson Strut, Coil Springs	Induction System	MFI		Fuel	13.2 gal. 13.2 gal.
STEERING		Horsepower (SAE net)	102 @ 5800		Engine Coolant	5.9 qt. 5.9 qt.
Type	Manual, rack-and-pinion (Power steering available)	Torque (SAE net)	101 @ 4800		Towing	N/A N/A
Ratio	24:1	Emission Control System	3-way exhaust, O ₂ sensor, (EGR) Calli. Toothed belt		Interior Volume (front/rear)	48.1/34.8 cu.ft. 48.2/34.2 cu.ft.
Turns, lock-to-lock	4.3	Cam Drive			Trunk/Cargo Volume	11.2 cu.ft. 17.3 cu.ft.
Turning Diameter, curb-to-curb	31.5 ft.	Recommended Fuel (minimum)	87 octane		Weight-to-Power Ratio	22.8 lb/hp 23.3 lb/hp
BRAKES					Frontal Area	20.15 ft. ² 20.15 ft. ²
Type	Power, Vacuum				Specific Output	64.2 hp/ltr 64.2 hp/ltr
Front, size	Ventilated Disc, 9.37 x .71 in.	DRIVETRAIN		DIMENSIONS		
Rear, size	Drum, 7.87 in.	Type	FWD	Exterior	Sedan	Hatchback
Total Swept Area	N/A	Transmission	Manual 5-speed	Wheelbase	95.7 in.	95.7 in.
WHEELS AND TIRES		Gear Ratios:		Tread Width (front/rear)	56.3/55.5 in.	56.3/55.5 in.
Wheel Size/Type	13 x 5.0 in., Stamped Steel	1st	3.54	Length Overall	170.7 in.	170.7 in.
Tire Size/Type	P175/70R13 all-season steel-belted radials	2nd	1.90	Width Overall	65.2 in.	65.2 in.
Spare Size	T115/70D14	3rd	1.31	Height Overall	52.4 in.	52.3 in.
		4th	0.97	Min. Ground Clearance	5.5 in.	5.5 in.
		5th	0.82	Weight Distribution (front/rear)	61/39%	59/41%
		Reverse	3.25	Curb Weight	2,321 lbs.	2,376 lbs.
		Axle Ratios Available:	3.72	Overhang (front/rear)	34.8/40.2 in.	34.8/40.2 in.
				Interior		
				Head Room (front/rear)	38.3/36.1 in.	38.3/35.5 in.
				Leg Room (front/rear)	40.9/31.6 in.	40.9/31.6 in.
				Shoulder Room (front/rear)	53.2/52.7 in.	53.2/52.7 in.
				Hip Room (front/rear)	49.6/52.3 in.	49.6/52.3 in.

Geo Prizm

Geo PRIZM	MODEL NUMBER	PASSENGER CAPACITY
4-Door Notchback Sedan	1SK19*	All models
4-Door Hatchback Sedan	1SK68*	
4-Door GSi Notchback Sedan	1SL19	
4-Door GSi Hatchback Sedan	1SL68	*LSi exterior/interior upgrade available.

5

Geo Prizm LSi Hatchback Sedan.

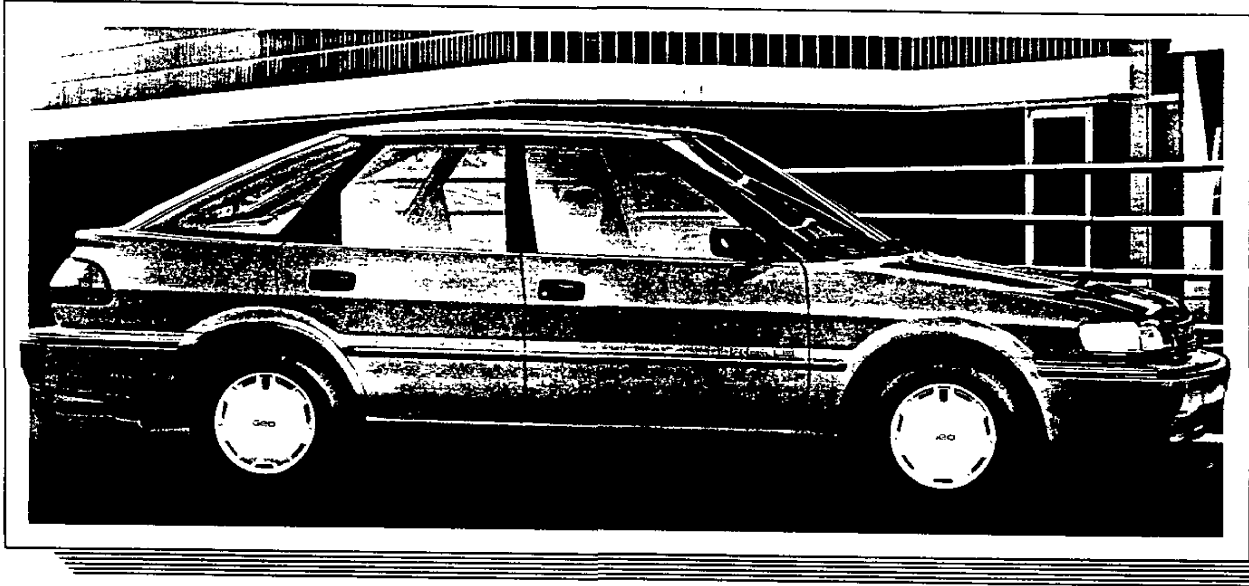

HIGHLIGHTS

- Geo Prizm GSi sport-level models join base and LSi models.
- 1.6 Liter dual overhead camshaft (DOHC) L4 with 16 valves and Multi-Port Fuel Injection (MPI) standard (higher performance version with GSi).
- Optional LSi exterior/interior upgrade includes Two-Tone Custom Cloth fabric seats with specific stitch and sew pattern, 60/40 split-folding rear seat-back with integral pillow-type head restraints (with trunk pass-through feature on Notchback), soft-feel steering wheel, LH and RH covered visor vanity mirrors, full wheel covers, specific exterior color treatment and LSi designators.
- GSi sport models include specific interior trim, AM/FM stereo radio, specific exterior treatment, specific 14" aluminum wheels and Eagle GT tires, front stabilizer bar, 4-wheel power disc brakes, tachometer and oil pressure gauges with 120-mpm speedometer, dual tail pipe diffuser vertical driver's seat adjustment, GSi exterior designators and additional equipment.
- 4-speed electronically controlled automatic transmission optional for GSi.

EQUIPMENT AVAILABILITY

Composite halogen headlamps	S	S	S
One-piece black molded 5-mph bumpers with chrome accents	S	NA	NA
Body-color bumper fascias	NA	S	NA
Body-color bumpers with accent-color bead	NA	NA	S
Argent/silver radiator grille	S	NA	NA
Body-color radiator grille	NA	S	S
Tinted glass	S	S	S
Chrome window, belt and drip moldings	S	S	NA
Black window, belt and drip moldings	NA	NA	S
Blackout door pillar treatment	S	S	S
Black body-side moldings with chrome accents	S	S	NA
Body-color body-side moldings with accent-color bead	NA	NA	S
Rear garnish molding	NA/S	S	S
Remote fuel filler door	S	S	S
Passenger assist grips	NA	S	S
60/40 split-folding rear seat-back	NA/S	S	O/S
Rear seat pillow-type headrests (integral with seat-back)	NA/S	S	O/S
Electric rear window defogger	S	S	S
Rear window wiper/washer	NA	NA/S	NA/S
Rear spoiler	NA	NA	S
13" Full wheel covers	O	S	NA
14" Aluminum wheels	NA	NA	S
P175/70R-13 all-season radial tires	S	S	NA
P185/60HR-14 Eagle GT radial tires	NA	NA	S
Rear compartment security cover	NA/S	NA/S	NA/S
Power front disc/rear drum brakes	S	S	NA
Power front and rear disc brakes	NA	NA	S
Rock-and-pinion steering	S	S	S*

S—Standard. O—Optional at Extra Cost. NA—Not Available
*Power steering standard on GSi.

Geo Prizm Notch/Hatch Sedans	Geo Prizm LSi Notch/Hatch Sedans	Geo Prizm GSi Notch/Hatch Sedans
S	S	S
S	NA	NA
NA	S	NA
NA	NA	S
S	NA	NA
NA	S	NA
S	S	S
S	S	S
S	S	NA
NA	NA	S
NA/S	S	S
S	S	S
NA	NA/S	NA/S
NA	NA	S
O	S	NA
NA	NA	S
S	S	NA
NA	NA	S
NA/S	NA/S	NA/S
S	S	NA
NA	NA	S
S	S	S*

Refer to Passenger Car Order Guide for option availability and application.

ORDERING INFORMATION

PREFERRED EQUIPMENT GROUPS

NOTE: NOT TO BE USED FOR ORDERING. REFER TO ORDER GUIDE FOR CURRENT USAGE AND AVAILABILITY

DESCRIPTION	Geo PRIZM NOTCH/HATCH SEDANS				Geo PRIZM LSi NOTCH/HATCH SEDANS			Geo PRIZM GSi NOTCH/HATCH SEDANS					
	PE.G. 1*	PE.G. 2	PE.G. 3	PE.G. 4	PE.G. 5	PE.G. 6	PE.G. 7	PE.G. 1	PE.G. 2	PE.G. 3	PE.G. 4	PE.G. 5	PE.G. 6
5-Speed Manual Transmission	X		X		X			X		X		X	
Automatic Transmission		X		X		X	X		X		X		X
LSi Exterior/Interior Upgrade					X	X	X						
Dual Mirrors (LH Remote)	X	X	X	X	S	S	S	S	S	S	S	S	S
AM/FM Stereo Radio with Seek and Scan, Digital Clock and 4 Speakers	X	X	X	X	X	X	X	S	S	S	S		
AM/FM Stereo Radio with Seek and Scan, Cassette, Digital Clock and 4 Speakers												X	X
Power Steering	X	X	X	X	X	X	X	S	S	S	S	S	S
Full Wheel Covers	X	X	X	X	X	X	X						
Air Conditioning			X	X	X	X	X			X	X	X	X
Power Door Lock System			X	X	X	X	X			X	X	X	X
Tilt Steering Wheel					X	X	X			X	X	X	X
Remote Trunk/Hatch Release			X	X	X	X	X			X	X	X	X
Power Windows							X					X	X
Electronic Speed Control							X					X	X
Intermittent Wiper System							X					X	X
Dual Vanity Mirrors					S	S	S			X	X	X	X
Split-Folding Rear Seat-Back (Notch Only)					S	S	S			X	X	X	X
INDIVIDUAL OPTIONS													
Radio Equipment													
AM/FM Stereo Radio with Seek and Scan, Cassette, Digital Clock and 4 Speakers			O†				O			O		X	X
Additional Individual Options													
Air Conditioning	O†	O	X	X	X	X	X	O	O	X	X	X	X
Floor Mats, Front/Rear		O					O			X	X	X	X
Electric Sunroof (Includes Map Light)		O†					O			O			

X-Included in Preferred Equipment Group. S-Standard. O-Available as an Individual Option.
 *Base vehicles may be ordered by specifying Base Vehicle Preferred Equipment Group.
 †Not available with Base Vehicle Preferred Equipment Groups

Refer to Passenger Car Order Guide for option availability and application.

WHEEL TRIM

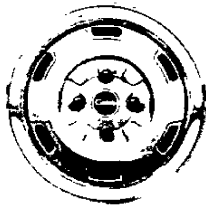

Standard Geo Prizm argent-color Styled Steel Wheels.



13" Full Wheel Covers, included with all Preferred Equipment Groups except Base Vehicle Groups.

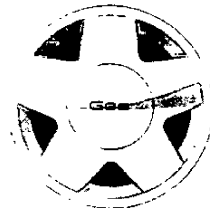

Geo Prizm GSI 14" Aluminum Wheels.

RADIOS



Electronically tuned AM/FM stereo radio with Seek and Scan and digital clock (RPO UM7). Standard on GSI models, optional all others.

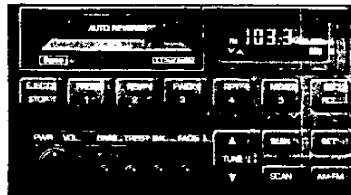

Optional electronically tuned AM/FM stereo radio with Seek and Scan, stereo cassette tape player and digital clock (RPO UM6).

SEE ORDER GUIDE FOR SPECIFIC RADIO AVAILABILITY.

VALUE FEATURES

Geo Prizm models include many standard features that enhance operation, safety and convenience. For 1990, these include:

- Front drive.
- Power front disc/rear drum brake system.
- Rack-and-pinion steering.
- **Scotchgard™** Fabric Protector for seat and door trims.
- Cut-pile carpeting.
- Color-coordinated safety belt system with 2-point passive driver and front passenger restraints with active lap belts, rear outer position 3-point active lap/shoulder belts and rear center active lap belt.
- Automatic transmission shift interlock.
- Childproof rear door lock mechanisms.
- Electric rear window defogger.
- Luggage area lamp.
- 5-mph bumpers.
- MacPherson strut front and rear independent suspension.
- Stone damage protection on rocker panels.
- Underbody protective coating.

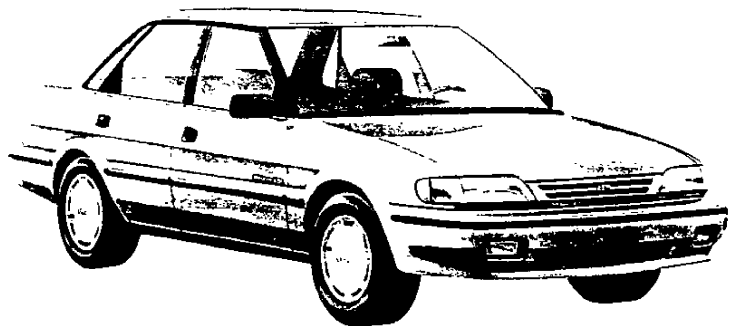

© 1989 General Motors Corporation. All rights reserved.

All illustrations and specifications in this brochure are based on the latest product information available at the time of publication approval. The right is reserved to make changes at any time without notice, in colors, materials, specifications and models, and also to discontinue models.

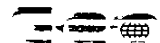

Refer to Passenger Car Order Guide for option availability and application.

SEAT TYPES & COLORS™

Geo PRIZM CLOTH SEAT TRIM



Standard cloth seat trim available in Blue, Brown or Gray.

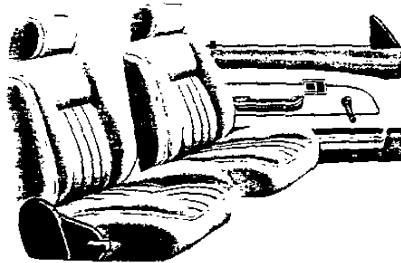

Standard full cloth low-back reclining front bucket seats with angle adjustments and vertically adjusting head restraints.

Geo PRIZM LSi TWO-TONE CUSTOM CLOTH SEAT TRIM



LSi Two-Tone Custom Cloth seat trim available in Blue, Brown or Gray.

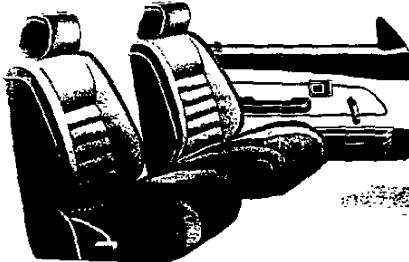

LSi Two-Tone Custom Cloth low-back reclining front bucket seats with angle adjustments and vertically adjusting head restraints.

Geo PRIZM GSi CUSTOM SPORT CLOTH SEAT TRIM

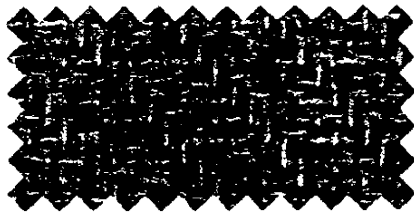

GSi Custom Sport Cloth seat trim available in Gray.

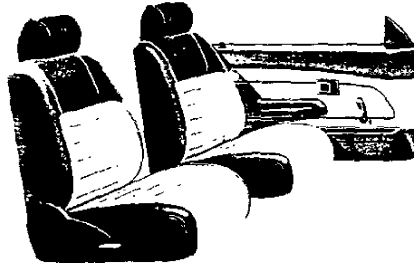

GSi low-back reclining front bucket seats. Vinyl backs and bolsters with Custom Sport Cloth inserts. Adjustable vertical head restraints. Driver's seat includes vertical height adjuster.

Refer to Passenger Car Order Guide for option availability and application.

Geo SPECIFICATIONS — 1990 PRIZM

MODELS

PASSENGERS

*Geo Prizm 4-Door Notchback Sedan (1SK19)	5
*Geo Prizm 5-Door Hatchback Sedan (1SK68)	5
Geo Prizm 4-Door GSi Notchback Sedan (1SL19)	5
Geo Prizm 5-Door GSi Hatchback Sedan (1SL68)	5

*Available with LSi Exterior/Interior Trim

DIMENSIONS (inches)

EXTERIOR

Wheelbase	95.7
Length (overall)	170.7
Width (overall)	65.2
Height (loaded)	52.4
Tread-Front/Rear	56.3/55.5
	GSi 56.9/56.1

INTERIOR

Head Room-Front/Rear	Notchback 38.3/36.1
	Hatchback 38.3/35.5
	with Sun Roof Notchback 37.1/36.1
	with Sun Roof Hatchback 37.1/35.6
Shoulder Room-Front/Rear	53.2/52.7
Hip Room-Front/Rear	49.6/52.3
Leg Room-Front/Rear	40.8/31.6

LUGGAGE COMPARTMENT/CARGO CAPACITY (cu. ft.)

Usable Luggage Capacity	Notchback 11.2
Cargo Volume with Rear Seat Up	Hatchback 17.3
Cargo Volume with Rear Seat Down	Hatchback 32.2

FUEL TANK CAPACITY (gallons) 13.2

CURB WEIGHT (approx. lbs.)

	Notchback 2347
	LSi Notchback 2378
	Hatchback 2397
	LSi Hatchback 2424
	GSi Notchback 2465
	GSi Hatchback 2529

POWER TEAMS

STANDARD ENGINE

- RPO L01, 1.6 Liter (97 cu. in.) L4 with Multi-Port Fuel Injection (MFI)
- RPO LWO 1.6 Liter (97 cu. in.) L4 with Multi-Port Fuel Injection (MFI) (GSi)

STANDARD TRANSMISSION

- 5-Speed Manual w/Overdrive 4th & 5th Gears

OPTIONAL TRANSMISSION

- 3-Speed Automatic (N/A GSi)
- 4-Speed Automatic (Electronically Controlled) (GSi Only)

STANDARD EQUIPMENT SUMMARY

Composite Halogen Headlamps
 One-Piece Black Molded 5-MPH Bumpers with Chrome Accents (Body Color with Color Accent on GSi)
 Tinted Windshield with Shaded Area at Top Tinted Glass
 Black Body Side Moldings with Chrome Accent (Body Color Side Moldings with Color Accent) (GSi)
 Chrome Roof Drip, Door Belt and Quarter Window Moldings (Black on GSi)
 Chrome Windshield and Rear Window Moldings (Black on GSi)
 Black-Out Pillar Treatment
 P175/70R-13 All-Season Steel-Belted Blackwall Radial Tires
 Headlamps-On Warning Tone
 Slide-Out Cup Holder
 Rear Window Defogger
 Remote Fuel Filler Door
 Cut-Pile Carpeting
 Luggage Area Lamp
 Low Lift-Over Rear Hatch and Trunk Openings
 Child-Proof Rear Door Latch and Lock Mechanisms
 4-Wheel Independent Suspension
 Power Front Disc/Rear Drum Brakes (4-Wheel Disc) (GSi)
 Rack-and-Pinion Steering
 Rear Stabilizer Bar (Front/Rear Stabilizer Bars) (GSi)
 Rear Compartment Security Cover (Hatchback)
 LH Remote Mirror
 Outside LH Remote and RH Manual Mirrors (GSi)
 Power Steering (GSi)
 Rear Spoiler (GSi)
 P185/60 HR-14 All Season Blackwall Tires (GSi)
 14" Aluminum Wheels (GSi)
 Rear Window Windshield Wiper System (LSi and GSi Hatchback Only)
 AM/FM Stereo Radio with Seek-Scan and Digital Clock (Incls Dual Front and Rear Speakers) (GSi)
 Tachometer and Oil Pressure Gages (GSi)

SEAT STYLES

Base—Cloth Reclining Bucket Seats with Adjustable Head Restraints (Split-Folding 60/40 Rear Seat in Hatchback)
 LSi—Custom Cloth Reclining Front Bucket Seats with Adjustable Head Restraints; Split-Folding 60/40 Rear Seat
 GSi—Custom Sport Cloth/Vinyl Reclining Front Bucket Seats with Driver Vertical Height Adjust and Adjustable Head Restraints. (Split-Folding 60/40 Rear Seat in Hatchback)

PRIZM NOTCHBACK SEDAN

COLOR AND TRIM SELECTION

PLEASE NOTE: The Exterior Paint and Interior Trim Combinations Shown Below are the Only Combinations that are Available

Interior Trim Color		Blue	Brown	Gray
MODEL	SEAT TYPE			
1SK19	Cloth Bucket	ADD2	AWW2	AQQ2

SOLID PAINT APPLICATION

Exterior Paint Color	Color Code 1	Color Code 2	Blue	Brown	Gray
Blue, Dark (Met)	26	26	•		
Blue, Light (Met)	22	22	•		
Chestnut, Dark (Met)	64	64		•	
Gray, Medium (Met)	90	90			•
Red, Bright	81	81			•
White	11	11		•	

POWER TEAMS (Refer to next page for option availability and application)

ENGINE OPTION CONDITION	RATIO	
	3.53	3.72
WITH NA5 STANDARD EMISSIONS		
L01 5-SPEED MANUAL TRANSMISSION	—	Std
3-SPEED AUTOMATIC TRANSMISSION	Std	—
WITH YF5 CALIFORNIA EMISSIONS		
L01 5-SPEED MANUAL TRANSMISSION	—	Std
3-SPEED AUTOMATIC TRANSMISSION	Std	—

PRIZM NOTCHBACK SEDAN

10,460.00 **Model 1SK19 Prizm Notchback Sedan**

PREFERRED VEHICLE

MUST ORDER ONE GROUP — NO DELETIONS ALLOWED

	S4M1	S4A2	S4M3	S4A4
609.00 Preferred Equipment Group 1				
Transmission: 5-Speed Manual	x		x	
Mirrors: Outside, LH Remote and RH Manual	x	x	x	x
Radio, Electronically Tuned AM/FM Stereo w/Seek-Scan and Digital Clock	x	x	x	x
Steering, Power	x	x	x	x
Wheel Covers, Full	x	x	x	x
1,074.00 Preferred Equipment Group 2				
Transmission: Automatic		x		x
1,554.00 Preferred Equipment Group 3				
Air Conditioning			x	x
Power Door Lock System			x	x
Remote Trunk/Hatch Release			x	x
2,019.00 Preferred Equipment Group 4				

Base Vehicles may be ordered by specifying Preferred Equipment Group Code S4MB (Incls 5-Speed Manual Transmission, P175/70 SR-13 B/W Tires and LH Remote Mirror.)

REGIONALIZED OPTIONS

ADDITIONAL OPTIONS MAY BE ORDERED FROM THIS LISTING ONLY

ENGINE (Must Order)		ADDITIONAL OPTIONS	
N.C.	LO1 1.6 Liter MFI	690.00	C60 Air Conditioning (N/A w/Group S4MB) (Incl w/Groups S4M3 and S4A4)
EMISSION (Must Order One)		40.00	B37 Floor Covering: Mats, Color-Keyed. Front and Rear
N.C.	NA5 Standard Emissions	530.00	CA1 Sun Roof, Electric (Incls Map Light) (N/A w/Group S4MB)
70.00	YF5 California Emissions		
RADIO EQUIPMENT			
V.P.S.	UM6 Electronically Tuned AM/FM Stereo Radio w/Seek-Scan, Stereo Cassette Tape and Digital Clock (Incls Dual Front and Rear Speakers) (N/A w/Group S4MB)		

PRIZM LSi NOTCHBACK SEDAN

COLOR AND TRIM SELECTION

PLEASE NOTE: The Exterior Paint and Interior Trim Combinations Shown Below are the Only Combinations that are Available

Interior Trim Color	Blue	Brown	Gray
MODEL	SEAT TYPE		
1SK19	Custom Cloth Bucket	BDD2	BWW2 BQQ2

SOLID PAINT APPLICATION

Exterior Paint Color	Color Code 1	Color Code 2	Blue	Brown	Gray
Blue, Dark (Met)	26	26	●		
Blue, Light (Met)	22	22	●		
Chestnut, Dark (Met)	64	64		●	
Gray, Medium (Met)	90	90			●
Red, Bright	81	81			●
White	11	11		●	

POWER TEAMS (Refer to next page for option availability and application)

ENGINE OPTION CONDITION	RATIO	
	3.53	3.72
WITH NA5 STANDARD EMISSIONS		
L01 5-SPEED MANUAL TRANSMISSION	—	Std
3-SPEED AUTOMATIC TRANSMISSION	Std	—
WITH YF5 CALIFORNIA EMISSIONS		
L01 5-SPEED MANUAL TRANSMISSION	—	Std
3-SPEED AUTOMATIC TRANSMISSION	Std	—

PRIZM LSi NOTCHBACK SEDAN

10,460.00 **Model 1SK19 Prizm LSi Notchback Sedan**

PREFERRED VEHICLE

MUST ORDER ONE GROUP — NO DELETIONS ALLOWED

	S4M5	S4A6	S4A7
2,084.00 Preferred Equipment Group 5			
Transmission: 5-Speed Manual	x		
Air Conditioning	x	x	x
LSi Exterior/Interior Trim	x	x	x
Mirrors: Outside, LH Remote and RH Manual	x	x	x
Power Door Lock System	x	x	x
Radio, Electronically Tuned AM/FM Stereo w/Seek-Scan and Digital Clock	x	x	x
Remote Trunk/Hatch Release	x	x	x
Steering, Power	x	x	x
Steering Wheel, Tilt	x	x	x
Wheel Covers, Full	x	x	x
2,549.00 Preferred Equipment Group 6			
Transmission: Automatic		x	x
3,049.00 Preferred Equipment Group 7			
Power Windows			x
Speed Control, Electronic: With Resume Speed			x
Windshield Wiper System: Intermittent			x

LSi Exterior/Interior Trim (Incls Split Fold Down Rear Seat, Soft Steering Wheel, LH and RH Covered Visor Vanity Mirrors, Passenger Assist Grips, Body Color Bumpers and Grille)

REGIONALIZED OPTIONS

ADDITIONAL OPTIONS MAY BE ORDERED FROM THIS LISTING ONLY

ENGINE (Must Order)		ADDITIONAL OPTIONS	
N.C.	L01 1.6 Liter MFI	40.00	B37 Floor Covering: Mats, Color-Keyed, Front and Rear
EMISSION (Must Order One)			
N.C.	NA5 Standard Emissions	530.00	CA1 Sun Roof, Electric (Incls Map Light)
70.00	YF5 California Emissions		
RADIO EQUIPMENT			
V.P.S.	UM6 Electronically Tuned AM/FM Stereo Radio w/Seek-Scan, Stereo Cassette Tape and Digital Clock (Incls Dual Front and Rear Speakers)		

PRIZM HATCHBACK SEDAN

COLOR AND TRIM SELECTION

PLEASE NOTE: The Exterior Paint and Interior Trim Combinations Shown Below are the Only Combinations that are Available

Interior Trim Color		Blue	Brown	Gray
MODEL	SEAT TYPE			
1SK68	Cloth Bucket	ADD2	AWW2	AQQ2

SOLID PAINT APPLICATION

Exterior Paint Color	Color Code 1	Color Code 2	Blue	Brown	Gray
Blue, Dark (Met)	26	26	●		
Blue, Light (Met)	22	22	●		
Chestnut, Dark (Met)	64	64		●	
Gray, Medium (Met)	90	90			●
Red, Bright	81	81			●
White	11	11		●	

POWER TEAMS (Refer to next page for option availability and application)

ENGINE OPTION CONDITION	RATIO	
	3.53	3.72
WITH NA5 STANDARD EMISSIONS		
L01 5-SPEED MANUAL TRANSMISSION	—	Std
3-SPEED AUTOMATIC TRANSMISSION	Std	—
WITH YF5 CALIFORNIA EMISSIONS		
L01 5-SPEED MANUAL TRANSMISSION	—	Std
3-SPEED AUTOMATIC TRANSMISSION	Std	—

PRIZM HATCHBACK SEDAN

10,760.00 **Model 1SK68 Prizm Hatchback Sedan**

PREFERRED VEHICLE

MUST ORDER ONE GROUP — NO DELETIONS ALLOWED

	S5M1	S5A2	S5M3	S5A4
609.00 Preferred Equipment Group 1				
Transmission: 5-Speed Manual	x		x	
Mirrors: Outside, LH Remote and RH Manual	x	x	x	x
Radio, Electronically Tuned AM/FM Stereo w/Seek-Scan and Digital Clock	x	x	x	x
Steering, Power	x	x	x	x
Wheel Covers, Full	x	x	x	x
1,074.00 Preferred Equipment Group 2				
Transmission: Automatic		x		x
1,554.00 Preferred Equipment Group 3				
Air Conditioning			x	x
Power Door Lock System			x	x
Remote Trunk/Hatch Release			x	x
2,019.00 Preferred Equipment Group 4				

Base Vehicles may be ordered by specifying Preferred Equipment Group Code S5MB (Incls 5-Speed Manual Transmission, P175/70 SR-13 B/W Tires and LH Remote Mirror.)

REGIONALIZED OPTIONS

ADDITIONAL OPTIONS MAY BE ORDERED FROM THIS LISTING ONLY

ENGINE (Must Order)		ADDITIONAL OPTIONS	
N.C.	L01 1.6 Liter MFI	690.00	C60 Air Conditioning (N/A w/Group S5MB) (Incl w/Groups S5M3 and S5A4)
EMISSION (Must Order One)		40.00	B37 Floor Covering: Mats, Color-Keyed, Front and Rear
N.C.	NA5 Standard Emissions	530.00	CA1 Sun Roof, Electric (Incls Map Light) (N/A w/Group S5MB)
70.00	YF5 California Emissions		
RADIO EQUIPMENT			
V.P.S.	UM6 Electronically Tuned AM/FM Stereo Radio w/Seek-Scan, Stereo Cassette Tape and Digital Clock (Incls Dual Front and Rear Speakers) (N/A w/Group S5MB)		

PRIZM LSi HATCHBACK SEDAN

COLOR AND TRIM SELECTION

PLEASE NOTE: The Exterior Paint and Interior Trim Combinations Shown Below are the Only Combinations that are Available

Interior Trim Color		Blue	Brown	Gray
MODEL	SEAT TYPE			
1SK68	Custom Cloth Bucket	BDD2	BWW2	BQQ2

SOLID PAINT APPLICATION

Exterior Paint Color	Color Code 1	Color Code 2	Blue	Brown	Gray
Blue, Dark (Met)	26	26	•		
Blue, Light (Met)	22	22	•		
Chestnut, Dark (Met)	64	64		•	
Gray, Medium (Met)	90	90			•
Red, Bright	81	81			•
White	11	11		•	

POWER TEAMS (Refer to next page for option availability and application)

ENGINE OPTION CONDITION	RATIO	
	3.53	3.72
WITH NA5 STANDARD EMISSIONS		
L01 5-SPEED MANUAL TRANSMISSION	—	Std
3-SPEED AUTOMATIC TRANSMISSION	Std	—
WITH YF5 CALIFORNIA EMISSIONS		
L01 5-SPEED MANUAL TRANSMISSION	—	Std
3-SPEED AUTOMATIC TRANSMISSION	Std	—

PRIZM LSi HATCHBACK SEDAN

10,760.00 **Model 1SK68 Prizm LSi Hatchback Sedan**

PREFERRED VEHICLE

MUST ORDER ONE GROUP — NO DELETIONS ALLOWED

	S5M5	S5A6	S5A7
2,019.00 Preferred Equipment Group 5			
Transmission: 5-Speed Manual	x		
Air Conditioning	x	x	x
LSi Exterior/Interior Trim	x	x	x
Mirrors: Outside, LH Remote and RH Manual	x	x	x
Power Door Lock System	x	x	x
Radio, Electronically Tuned AM/FM Stereo w/Seek-Scan and Digital Clock	x	x	x
Remote Trunk/Hatch Release	x	x	x
Steering, Power	x	x	x
Steering Wheel, Tilt	x	x	x
Wheel Covers, Full	x	x	x
2,484.00 Preferred Equipment Group 6			
Transmission: Automatic		x	x
2,984.00 Preferred Equipment Group 7			
Power Windows			x
Speed Control, Electronic: With Resume Speed			x
Windshield Wiper System: Intermittent			x

LSi Exterior/Interior Trim (Incls Soft Steering Wheel, LH and RH Covered Visor Vanity Mirrors, Body Color Bumpers and Grille, Passenger Assist Grips and Rear Window Windshield Wiper System.)

REGIONALIZED OPTIONS

ADDITIONAL OPTIONS MAY BE ORDERED FROM THIS LISTING ONLY

ENGINE (Must Order)		ADDITIONAL OPTIONS	
N.C.	L01 1.6 Liter MFI	40.00	B37 Floor Covering: Mats, Color-Keyed, Front and Rear
EMISSION (Must Order One)			
N.C.	NA5 Standard Emissions	530.00	CA1 Sun Roof, Electric (Incls Map Light)
70.00	YF5 California Emissions		
RADIO EQUIPMENT			
V.P.S.	UM6 Electronically Tuned AM/FM Stereo Radio w/Seek-Scan, Stereo Cassette Tape and Digital Clock (Incls Dual Front and Rear Speakers)		

PRIZM GSI NOTCHBACK AND HATCHBACK SEDAN

COLOR AND TRIM SELECTION

PLEASE NOTE: The Exterior Paint and Interior Trim Combinations Shown Below are the Only Combinations that are Available

Interior Trim Color		Gray
MODEL	SEAT TYPE	
1SL19/ 1SL68	Custom Sport Cloth Bucket	CQ02

SOLID PAINT APPLICATION

Exterior Paint Color	Color Code 1	Color Code 2	Gray
Gray, Medium (Met)	90	90	●
Red, Bright	81	81	●
White	11	11	●

POWER TEAMS (Refer to next page for option availability and application)

ENGINE OPTION CONDITION	RATIO	
	2.96	4.31
WITH NA5 STANDARD EMISSIONS		
LW0 5-SPEED MANUAL TRANSMISSION	—	Std
4-SPEED AUTOMATIC TRANSMISSION	Std	—
WITH YF5 CALIFORNIA EMISSIONS		
LW0 5-SPEED MANUAL TRANSMISSION	—	Std
4-SPEED AUTOMATIC TRANSMISSION	Std	—

PRIZM GSi NOTCHBACK AND HATCHBACK SEDAN

12,235.00 **Model 1SL19 Prizm GSi Notchback Sedan**
 12,620.00 **Model 1SL68 Prizm GSi Hatchback Sedan**

PREFERRED VEHICLE

MUST ORDER ONE GROUP — NO DELETIONS ALLOWED

N.C. Preferred Equipment Group 1	SGM1	SGA2	SGM3	SGA4	SGM5	SGA6
Transmission: 5-Speed Manual	x		x		x	
775.00 Preferred Equipment Group 2						
Transmission: 4-Speed Automatic (Electronically Controlled)		x		x		x
1059.00 Preferred Equipment Group 3 (1SL19 Model)						
909.00 Preferred Equipment Group 3 (1SL68 Model)						
Air Conditioning			x	x	x	x
Floor Mats, Color-Keyed Front and Rear			x	x	x	x
Mirrors, Dual Visor Vanity			x	x	x	x
Remote Trunk/Hatch Release			x	x	x	x
Seat, Split Folding Rear (Notchback Only)			x	x	x	x
Steering Wheel, Tilt			x	x	x	x
1834.00 Preferred Equipment Group 4 (1SL19 Model)						
1684.00 Preferred Equipment Group 4 (1SL68 Model)						
1904.00 Preferred Equipment Group 5 (1SL19 Model)						
1754.00 Preferred Equipment Group 5 (1SL68 Model)						
Power Door Locks					x	x
Power Windows					x	x
Radio, Electronically Tuned AM/FM Stereo w/Seek-Scan, Stereo Cassette Tape and Digital Clock					x	x
Speed Control, Electronic: With Resume Speed					x	x
Windshield Wiper System: Intermittent					x	x
2679.00 Preferred Equipment Group 6 (1SL19 Model)						
2529.00 Preferred Equipment Group 6 (1SL68 Model)						

REGIONALIZED OPTIONS

ADDITIONAL OPTIONS MAY BE ORDERED FROM THIS LISTING ONLY

ENGINE (Must Order)		ADDITIONAL OPTIONS	
N.C.	LWO 1.6 Liter MFI	690.00	C60 Air Conditioning (Incl w/Groups SGM3, SGA4, SGM5 and SGA6)
EMISSION (Must Order One)			
N.C.	NA5 Standard Emissions	530.00	CA1 Sun Roof, Electric (Incls Map Light)
70.00	YF5 California Emissions		
RADIO EQUIPMENT			
V.P.S.	UM6 Electronically Tuned AM/FM Stereo Radio w/Seek-Scan, Stereo Cassette Tape and Digital Clock (Incls Dual Front and Rear Speakers) (Incl w/Groups SGM5 and SGA6))		

NOTES

MANUFACTURERS MOTOR VEHICLE SPECIFICATIONS

METRIC (U.S. Customary)

1990

Manufacturer Toyota Motor Corporation	Vehicle Line Geo PRIZM	
Mailing Address Chevrolet-Pontiac-Canada Group Engineering Center General Motors Corporation 30003 Van Dyke Warren, Michigan 48090-9060	Issued June, 1989	Revised September, 1989

Direct questions concerning these specifications to the manufacturer listed above.

The information contained herein is prepared, distributed by, and is solely the responsibility of the vehicle manufacturing company to whose products it relates. This specification form was developed by the vehicle manufacturing companies under the auspices of the Motor Vehicle Manufacturers Association of the United States, Inc.

The General Specifications herein are those in effect at date of compilation and are subject to change without notice or incurring obligation by the manufacturer.



Motor Vehicle Manufacturers Association
of the United States, Inc.

Blank Forms Provided by Technical Affairs Division



.....

MVMA Specifications

METRIC (U.S. Customary)

Table of Contents

	1	Vehicle Models/Origin	
○	2	Power Teams	○ Indicates Format Change From Previous Year
	3	Engine	
	4	Lubrication System	
	4	Diesel Information	
	5	Cooling System	
	6	Fuel System	
	7	Vehicle Emission Control	
	7	Exhaust System	
○	8-10	Transmission, Axles and Shafts	
	11	Suspension	
	12-13	Brakes	
	13	Tires and Wheels	
	14-15	Steering	
	15-16	Electrical	
	17	Body — Miscellaneous Information	
	18	Restraint System	
	18	Glass	
	18	Headlamps	
	18	Frame	
	19-20	Convenience Equipment	
○	21-23	Vehicle Dimensions	
	24	Vehicle Fiducial Marks	
○	25	Vehicle Mass (Weight)	
	26	Optional Equipment Differential Mass (Weight)	
	27-33	Vehicle Dimensions Definitions - Key Sheets	
○	34	Index	

NOTE:

1. This form uses both SI metric units and U.S. Customary units. The metric unit of measure is presented first, and the U.S. Customary unit follows in parentheses.
2. UNLESS OTHERWISE INDICATED:
 - a. Specifications apply to standard models without optional equipment. Significant deviations are noted.
 - b. Nominal design dimensions are used throughout these specifications.
 - c. All linear dimensions are in millimeters (inches), and all mass (weight) specs. are in kilograms (pounds).
3. The General Specifications herein are those in effect at date of compilation and are subject to change without notice or incurring obligation by the manufacturer.
4. Additional Vehicle Dimensions (based in part on SAE J1100 "Motor Vehicle Dimensions") may be available from the manufacturer.

FORM MVMA-90

MVMA Specifications

Vehicle Line Geo PRIZM
 Model Year 1990 Issued 6-89 Revised(*) 9-89

METRIC (U.S. Customary)

○ Vehicle Origin

Design & development (company)	Toyota Motor Corporation
Where built (country)	U.S.A.
Authorized U.S. Sales marketing representative	Geo

○ Vehicle Models

Model Description & Drive (FWD/RWD/AWD/4WD)*	Introduction Date	Make, Vehicle Models, Series, Body Type (Mfg's Model Code)	No. of Designated Seating Positions (Front/Rear)	Max. Trunk/Cargo Load-Kilograms (Pounds)
Geo PRIZM				
4-Door Notchback Sedan (FWD)		1SK19	5 (2/3)	45 (100)
4-Door Hatchback Sedan (FWD)		1SK68	5 (2/3)	45 (100)
Geo PRIZM GSI				
4-Door Notchback Sedan (FWD)		1SL19	5 (2/3)	45 (100)
4-Door Hatchback Sedan (FWD)		1SL68	5 (2/3)	45 (100)

* FWD - Front Wheel Drive RWD - Rear Wheel Drive AWD - All Wheel Drive 4WD - Four Wheel Drive

MVMA Specifications

Vehicle Line Geo PRIZM
 Model Year 1990 Issued 6-89 Revised(*) 9-89

METRIC (U.S. Customary)

Engine Description	1.6 LITER L4 (97 CID)
Engine Code	MULTI-PORT FUEL INJECTION RPO LO1

ENGINE - GENERAL

Type & description (inline, V, angle, flat, location, front, mid, rear, transverse, longitudinal, sohc, dohc, ohv, hemi, wedge, pre-chamber, etc.)	Inline, Front, Transverse, DOHC Pent Roof	
Manufacturer	Toyota Motor Corporation	
No. of cylinders	4	
Bore	81.0 mm (3.2 in.)	
Stroke	77.0 mm (3.0 in.)	
Bore spacing (C/L to C/L)	87.5 mm (3.4 in.)	
Cyl block matl & mass kg(lbs., machined)	Cast Iron, 31.3	
Cylinder block deck height	191.0 mm (7.5 in.)	
Cylinder block length	391.5 mm (15.4 in.)	
Deck clearance (minimum) (above or below block)	0.00 mm	
Cyl. head material & mass kg (lbs.)	Aluminum Alloy, 9.3	
Cylinder head volume (cu. cm.)	30.2	
Cylinder liner material	Not Applicable	
Head gasket thickness (compressed)	1.20 mm (.05 in.)	
Minimum combustion chamber total volume (cm. cu.)	46.7	
Cyl. no. system (front to rear)	L. Bank	1-2-3-4
	R. Bank	
Firing order	1-3-4-2	
Intake manifold matl & mass (kg (lbs.))**	Aluminum Alloy, 2.8 *1, 3.1 *2	
Exh. manifold matl & mass (kg (lbs.))**	Spheroidal Graphite Cast Iron, 4.0	
Fuel required unleaded, diesel, etc.	Unleaded	
Fuel antiknock index (R + M) / 2	87	
Engine mounts	Quantity	5
	Matl and type (elastomeric, hydroelastic, hydraulic damper, etc.)	Rubber, Elastomeric
	Added isolation (sub-frame, crossmember, etc.)	Sub-Frame
Total dressed engine mass (wt) dry***	Manual Trans. 118 kg, Automatic Trans. 110 kg	

Engine - Pistons

*1: Fed. *2: Cal.

Material & mass, g (weight, oz.) - piston only	Aluminum Alloy, 293
--	---------------------

Engine Camshaft

Location	Over Cylinder Head	
Material & mass kg (weight, lbs.)	Gray Cast Iron, (IN) 1.4; (EX) 1.9	
Drive type	Chain/belt	Belt
	Width/pitch	19.1/9.525 mm (.75/.375 in.)

*Rear of engine - drive takeoff. View from drive takeoff end to determine left & right side of engine.
 **Finished state.
 ***Dressed engine mass (weight) includes the following:

MVMA Specifications

Vehicle Line Geo PRIZM
 Model Year 1990 Issued 6-89 Revised(*) 9-89

METRIC (U.S. Customary)

Engine Description **1.6 LITER L4 (97 CID)**
 Engine Code **MULTI-PORT FUEL INJECTION RPO LW0**

ENGINE - GENERAL

Type & description (inline, V, angle, flat, location, front, mid, rear, transverse, longitudinal, sohc, dohc, ohv, hemi, wedge, pre-chamber, etc.)	Inline, Front, Transverse, DOHC Pent Roof	
Manufacturer	Toyota Motor Corporation	
No. of cylinders	4	
Bore	81.0 mm (3.2 in.)	
Stroke	77.0 mm (3.0 in.)	
Bore spacing (C/L to C/L)	87.5 mm (3.4 in.)	
Cyl block matl & mass kg(lbs.)(machined)	Cast Iron, 31.3	
Cylinder block deck height	191.0 mm (7.5 in.)	
Cylinder block length	391.5 mm (15.4 in.)	
Deck clearance (minimum) (above or below block)	0.00 mm	
Cyl. head material & mass kg (lbs.)	Aluminum Alloy, 11.1	
Cylinder head volume (cu. cm.)	36.0	
Cylinder liner material	Not Applicable	
Head gasket thickness (compressed)	1.20 mm (.05 in.)	
Minimum combustion chamber total volume (cm. cu.)	47.2	
Cyl. no. system (front to rear)	L. Bank	1-2-3-4
	R. Bank	
Firing order	1-3-4-2	
Intake manifold matl & mass(kg(lbs.))**	Aluminum Alloy, 4.8	
Exh. manifold matl & mass (kg (lbs.))**	Spheroidal Graphite Cast Iron, 6.0	
Fuel required unleaded, diesel, etc.	Unleaded	
Fuel antiknock index (R + M) / 2	91	
Engine mounts	Quantity	5
	Matl and type (elastomeric, hydroelastic, hydraulic damper, etc.)	Rubber, Elastomeric
	Added isolation (sub-frame, crossmember, etc.)	Sub-Frame, Crossmember
Total dressed engine mass (wt) dry***	Manual Trans. 118.7 kg, Automatic Trans. 112.4 kg	

Engine - Pistons

Material & mass, g (weight, oz.) - piston only	Aluminum Alloy, 310
--	---------------------

Engine Camshaft

Location	Over Cylinder Head	
Material & mass kg (weight, lbs.)	Alloy Cast Iron, (No. 1) 1.66; (No.2) 1.65	
Drive type	Chain/belt	Belt
	Width/pitch	19,1/9.525 mm (.75/.375 in.)

*Rear of engine - drive takeoff. View from drive takeoff end to determine left & right side of engine.
 **Finished state.
 ***Dressed engine mass (weight) includes the following:

MVMA Specifications

Vehicle Line Geo PRIZM
 Model Year 1990 Issued 6-89 Revised(*) 9-89

METRIC (U.S. Customary)

Engine Description

Engine Code

1.6 LITER L4 (97 CID)
 MULTI-PORT FUEL INJECTION RPO L01

Engine - Valve System

Hydraulic lifters (std., opt., NA)		Not Applicable
Valves	Number intake/exhaust	8/8
	Head O.D. intake/exhaust	30/24.5 mm (1.18/.96 in.)

Engine - Connecting Rods

Material & mass [kg., (weight, lbs.)]*	Steel, 0.460
Length (axes centerline to centerline) mm	122

Engine - Crankshaft

Material & mass [kg., (weight, lbs.)]*	Spheroidal Graphite Cast Iron, 10.8	
End thrust taken by bearing (no.)	#3	
Length & number of main bearings	20.0 mm, 5	
Seal (material, one, two piece design, etc.)	Front	Acrylate, 1
	Rear	Silicone, 1

Engine - Lubrication System

Normal oil pressure (kPa (psi) @ eng rpm)	373 / 2000
Type oil intake (floating, stationary)	Stationary
Oil filter sys. (full flow, part, other)	Full Flow
Capacity of c/case, less filter-refill-L (qt.)	3.0 (3.2)

Engine - Diesel Information

(NOT APPLICABLE)

Diesel engine manufacturer	
Glow plug, current drain at 0 deg. F	
Injector Nozzle	Type
	Opening pressure [kPa (psi)]
Pre-chamber design	
Fuel injection pump	Manufacturer
	Type
Fuel inj. pump drive (belt, chain, gear)	
Supplementary vacuum source (type)	
Fuel heater (yes/no)	
Water separator, description (std., opt.)	
Turbo manufacturer	
Oil cooler-type (oil to engine coolant; oil to ambient air)	
Oil filter	

Engine - Intake System

(NOT APPLICABLE)

Turbo charger - manufacturer	
Super charger - manufacturer	
Intercooler	

* Finished State

MVMA Specifications

Vehicle Line Geo PRIZM
 Model Year 1990 Issued 6-89 Revised(*) 9-89

METRIC (U.S. Customary)

Engine Description
 Engine Code

1.6 LITER L4 (97 CID)
 MULTI-PORT FUEL INJECTION RPO LWO

Engine - Valve System

Hydraulic lifters (std., opt., NA)	Not Applicable	
Valves	Number intake/exhaust	8/8
	Head O.D. intake/exhaust	30.5/25.5 mm (1.20/1.00 in.)

Engine - Connecting Rods

Material & mass (kg., (weight, lbs.))*	Steel, 0.526
Length (axes centerline to centerline) mm	122

Engine - Crankshaft

Material & mass (kg., (weight, lbs.))*	Steel, 12.4	
End thrust taken by bearing (no.)	#3	
Length & number of main bearings	20.0 mm, 5	
Seal (material, one, two piece design, etc.)	Front	Acrylate, 1
	Rear	Silicone, 1

Engine - Lubrication System

Normal oil pressure (kPa (psi) @ eng rpm)	392 / 6000
Type oil intake (floating, stationary)	Stationary
Oil filter sys. (full flow, part, other)	Full Flow
Capacity of c/case, less filter-refill-L (qt.)	3.4 (3.6)

Engine - Diesel Information

(NOT APPLICABLE)

Diesel engine manufacturer	
Glow plug, current drain at 0 deg. F	
Injector Nozzle	Type
	Opening pressure (kPa (psi))
Pre-chamber design	
Fuel injection pump	Manufacturer
	Type
Fuel inj. pump drive (belt, chain, gear)	
Supplementary vacuum source (type)	
Fuel heater (yes/no)	
Water separator, description (std., opt.)	
Turbo manufacturer	
Oil cooler-type (oil to engine coolant; oil to ambient air)	
Oil filter	

Engine - Intake System

(NOT APPLICABLE)

Turbo charger - manufacturer	
Super charger - manufacturer	
Intercooler	

* Finished State

MVMA Specifications

Vehicle Line Geo PRIZM
 Model Year 1990 Issued 5-89 Revised(*) 9-89

METRIC (U.S. Customary)

Engine Description

1.6 LITER L4 (97 CID)

Engine Code

MULTI-PORT FUEL INJECTION RPO L01

Engine - Cooling System

Coolant recovery system (std, opt, n.a.)		Standard
Coolant fill location (rad., bottle)		Radiator
Radiator cap relief valve pressure (kPa (psi))		88.3
Circulation thermostat	Type (choke, bypass)	Bypass
	Starts to open @ deg's C(F)	82
Water Pump	Type (centrifugal, other)	Centrifugal
	GPM 1000 pump rpm	0.38 L/Sec
	Number of pumps	1
	Drive (V-belt, other)	V-Ribbed Belt
	Bearing type	Sealed Type
	Impeller material	Stainless Steel
Housing material		Aluminum Alloy
By-pass recirculation (type (inter., ext.))		External
Cooling system capacity	With heater - L (qt.)	5.6 (5.9)* 1, 5.5 (5.8)* 2
	With air conditioner-L(qt.)	5.6 (5.9)* 1, 5.5 (5.8)* 2
	Opt. equip.(specify-L(qt.))	Not Applicable
Water jackets full length of cyl(yes,no)		Yes
Water all around cylinder (yes, no)		No
Water jackets open at head face (yes,no)		No
Radiator core	Std., A/C, HD	Standard
	Type (cross-flow, etc.)	Vertical
	Construction (fin & tube mechanical, braze, etc.)	Corrugated Fin
	Matl., mass (kg(wgt.,lbs.))	Fin: Copper. Tube: Brass M/T 3.60; A/T 4.70
	Width	666.4 mm (26.2 in.)
	Height	326.3 mm (12.8 in.)
	Thickness	16.0 mm (.63 in.)
Fins per inch		21 (M/T) 23 (A/T)
Radiator end tank material		Resin
Fan	Std., elec., opt.	Elec.
	Number of blades & type (flex, solid, material)	4, Solid
	Diameter & projected width	300 x 88 mm (11.8 x 3.5 in.)
	Ratio(fan to crnkshft.rev.)	-
	Fan cutout type	Thermo Switch
	Drive type (direct, remote)	Motor
	RPM at idle (elec.)	2100
	Motor rating(wattage)(elec)	80
	Motor switch (type & location) (elec.)	Thermo Housing
	Switch point (temp., pressure)(elec.)	90 deg. C
Fan shroud (material)		Resin

*1: M/T

*2: 3 A/T

MVMA Specifications

Vehicle Line Geo PRIZM
 Model Year 1990 Issued 6-89 Revised(*) 9-89

METRIC (U.S. Customary)

Engine Description	1.6 LITER L4 (97 CID)
Engine Code	MULTI-PORT FUEL INJECTION RPO LWO

Engine - Cooling System

Coolant recovery system (std, opt, n.a.)	Standard	
Coolant fill location (rad., bottle)	Radiator	
Radiator cap relief valve pressure (kPa (psi))	88.3	
Circulation thermostat	Type (choke, bypass)	Bypass
	Starts to open @ deg's C(F)	82
Water Pump	Type (centrifugal, other)	Centrifugal
	GPM 1000 pump rpm	0.50 L/Sec
	Number of pumps	1
	Drive (V-belt, other)	V-Ribbed Belt
	Bearing type	Sealed Type
	Impeller material	Stainless Steel
	Housing material	Aluminum Alloy
By-pass recirculation [type (inter., ext.)]	External	
Cooling system capacity	With heater - L (qt.)	6.0 (6.3)
	With air conditioner-L(qt.)	6.0 (6.3)
	Opt. equip. [specify-L(qt.)]	Not Applicable
Water jackets full length of cyl(yes,no)	Yes	
Water all around cylinder (yes, no)	No	
Water jackets open at head face (yes,no)	No	
Radiator core	Std., A/C, HD	Standard
	Type (cross-flow, etc.)	Vertical
	Construction (fin & tube mechanical, braze, etc.)	Corrugated Fin
	Matl., mass (kg(wgt.,lbs.))	Fin: Copper. Tube: Brass M/T 3.51; A/T 4.02
	Width	666.4 mm (26.2 in.)
	Height	326.3 mm (12.8 in.)
	Thickness	16.0 mm (.63 in.)
	Fins per inch	21 (M/T, A/T)
Radiator end tank material	Resin	
Fan	Std., elec., opt.	Elec.
	Number of blades & type (flex, solid, material)	4, Solid
	Diameter & projected width	300 x 88 mm (11.8 x 3.5 in.)
	Ratio(fan to crnkshft.rev.)	-
	Fan cutout type	Thermo Switch
	Drive type (direct, remote)	Motor
	RPM at idle (elec.)	2100
	Motor rating(wattage)(elec.)	80
	Motor switch (type & location)(elec.)	Water Temperature, Water Inlet
	Switch point (temp., pressure)(elec.)	90 deg. C
	Fan shroud (material)	Resin

MVMA Specifications

Vehicle Line Geo PRIZM
 Model Year 1990 Issued 6-89 Revised(*) 9-89

METRIC (U.S. Customary)

Engine Description
 Engine Code

1.6 LITER L4 (97 CID)
 MULTI-PORT FUEL INJECTION RPO L01

Engine - Fuel System (See supplemental page for details of Fuel Inj. Supercharger, Turbocharger, etc. if used)

Induction type: carburetor, fuel injection system, etc.		Fuel Injection
Manufacturer		NIPPONDENSO
Carburetor no. of barrels		-
Idle A/F mix.		Preset At Manufacturer
Fuel Injection	Point of inj. (no.)	4
	Constant, pulse, flow	Pulse
	Control (elec., mech.)	Electronic
	Sys. press. (kPa (psi))	284
Idle spd.--rpm (spec. neutral or drive and propane if used)	Manual	700
	Automatic	700
Intake manifold heat control (exhaust or water thermostatic or fixed)		-
Air cleaner type		Dry Type, 1 Element
Fuel filter (type/location)		Filter Paper, Engine Room
Fuel pump	Type (elec. or mech.)	Electro Magnetic
	Location (eng., tank)	In Fuel Tank
	Press. range (kPa(psi))	284
	Flow rate at regulated pressure (L (gal)/hr @ kPa (psi))	MIN. 80. @ 284

Fuel Tank

Capacity (refill L (gallons))		50 (13.2)
Location (describe)		Under Rear Floor
Attachment		Banded
Material & Mass (kg (weight lbs.))		Steel Sheet
Filler pipe	Location & material	Left Wheel House, Steel Pipe
	Connection to tank	Rubber Hose
Fuel line (material)		Steel Pipe
Fuel hose (material)		Rubber
Return line (material)		Steel Pipe
Vapor line (material)		Steel Pipe
Extended range tank	Opt., n.a.	Not Applicable
	Capacity (L (gallons))	"
	Location & material	"
	Attachment	"
Auxiliary tank	Opt., n.a.	Not Applicable
	Capacity (L (gallons))	"
	Location & material	"
	Attachment	"
	Select switch or valve	"
	Separate fill	"

MVMA Specifications

Vehicle Line Geo PRIZM
 Model Year 1990 Issued 6-89 Revised(*) 9-89

METRIC (U.S. Customary)

Engine Description **1.6 LITER L4 (97 CID)**
 Engine Code **MULTI-PORT FUEL INJECTION RPO LWO**

Engine - Fuel System (See supplemental page for details of Fuel Inj. Supercharger, Turbocharger, etc. if used)

Induction type: carburetor, fuel injection system, etc.		Fuel Injection
Manufacturer		AISAN
Carburetor no. of barrels		-
Idle A/F mix.		Preset At Manufacturer
Fuel Injection	Point of inj. (no.)	4
	Constant, pulse, flow	Pulse
	Control (elec., mech.)	Electronic
	Sys. press. (kPa (psi))	284
Idle spd.-rpm (spec. neutral or drive and propane if used)	Manual	800
	Automatic	800
Intake manifold heat control (exhaust or water thermostatic or fixed)		-
Air cleaner type		Dry Type, 1 Element
Fuel filter (type/location)		Filter Paper, Engine Room
Fuel pump	Type (elec. or mech.)	Electro Magnetic
	Location (eng., tank)	In Fuel Tank
	Press. range (kPa (psi))	284
	Flow rate at regulated pressure (L (gal)/hr @ kPa (psi))	MIN. 80, @ 284

Fuel Tank

Capacity (refill L (gallons))		50 (13.2)
Location (describe)		Under Rear Floor
Attachment		Banded
Material & Mass (kg (weight lbs.))		Steel Sheet
Filler pipe	Location & material	Left Wheel House, Steel Pipe
	Connection to tank	Rubber Hose
Fuel line (material)		Steel Pipe
Fuel hose (material)		Rubber
Return line (material)		Steel Pipe
Vapor line (material)		Steel Pipe
Extended range tank	Opt., n.a.	Not Applicable
	Capacity [L (gallons)]	"
	Location & material	"
	Attachment	"
Auxiliary tank	Opt., n.a.	Not Applicable
	Capacity [L (gallons)]	"
	Location & material	"
	Attachment	"
	Sictr switch or valve	"
	Separate fill	"

MVMA Specifications

Vehicle Line Geo PRIZM
 Model Year 1990 Issued 6-89 Revised(*) 9-89

METRIC (U.S. Customary)

Engine Description
 Engine Code

1.6 LITER L4 (97 CID)
 MULTI-PORT FUEL INJECTION RPO L01

Vehicle Emission Control

Exhaust Emission Control	Type (air injection, engine modifications, other)		EFI + Oxygen Sensor + TWC *1 EFI + Oxygen Sensor + TWC + EGR*2
	Air injection	Pump or pulse	Not Applicable
		Driven by	"
		Air distribution (head, manifold, etc.)	"
		Point of entry	"
	Exhaust Gas Recirculation	Type (controlled flow, open orifice, other)	Exhaust Back Pressure
		Exhaust source	Cylinder Head
		Point of exh.inj. (spacer, carb., manifold, other)	Intake Manifold
	Catalytic Converter	Type	3-Way
		Number of	1
		Location(s)	Forward Under Floor Area
		Volume [L(cu.in)]	1.3
		Substrate type	Monolith
Noble metal type		Platinum (Pt), Rhodium (Rh)	
Noble metal concentration (g/cu. cm.)		-	
Crankcase Emission Control	Type (ventilates to atmosphere, induction system, other)		Closed
	Energy source (manifold vacuum, carburetor, other)		Manifold Vacuum, Crankcase Pressure
	Discharges (to intake manifold, other)		Intake Manifold
	Air inlt(breather cap, other)		Throttle Body
Evaporative Emission Control	Vapor vented to crankcase, canister, other)	Fuel tank	Canister
		Carburetor	-
	Vapor storage provision		Canister
Electronic System	Closed loop (yes/no)		Yes
	Open loop (yes/no)		No

*1: FED *2: CAL Spec

Engine - Exhaust System

Type (single, single with cross-over, dual, other)		Single
Muffler no. & type (reverse flow, straight thru, separate resonator) Material & Mass (kg (weight lbs.))		1, Straight Flow 1, Reverse Flow
Resonator no. & type		-
Exhaust pipe	Branch o.d., wall thickness	-
	Main o.d., wall thickness	42.7, 1.5 mm (1.68, .059 in.)
	Matl. & Mass (kg(wght.lbs.))	Stainless Steel, 1.3
Inter-mediate pipe	o.d. & wall thickness	48.6, 1.5 mm; 42.7, 1.4 mm; 42.7, 1.2 mm (1.91, .059 in.; 1.68, .055 in.; 1.68, .047 in.)
	Matl. & Mass (kg(wght.lbs.))	Stainless 0.4; A1 Coated 2.0; Stainless 0.5
Tail pipe	o.d. & wall thickness	42.7, 1.2 mm (1.68, .047 in.)
	Matl. & Mass (kg(wght.lbs.))	Aluminum Coated Steel, 0.5

MVMA Specifications

Vehicle Line Geo PRIZM
 Model Year 1990 Issued 6-89 Revised(*) 9-89

METRIC (U.S. Customary)

Engine Description **1.6 LITER L4 (97 CID)**
 Engine Code **MULTI-PORT FUEL INJECTION RPO LWO**

Vehicle Emission Control

Exhaust Emission Control	Type (air injection, engine modifications, other)		EFI + EGR + *Oxygen Sensor + TWC
	Air Injection	Pump or pulse	Not Applicable
		Driven by	"
		Air distribution (head, manifold, etc.)	"
		Point of entry	"
	Exhaust Gas Recirculation	Type (controlled flow, open orifice, other)	Exhaust Back Pressure
		Exhaust source	Exhaust Manifold
		Point of exh.inj. (spacer, carb., manifold, other)	Intake Manifold
	Catalytic Converter	Type	3-Way
		Number of	1
		Location(s)	Forward Under Floor Area
		Volume [L(cu.in)]	1.3
		Substrate type	Monolith
		Noble metal type	Platinum (Pt), Rhodium (Rh)
Crankcase Emission Control	Type (ventilates to atmosphere, induction system, other)		Sealed
	Energy source (manifold vacuum, carburetor, other)		Manifold Vacuum
	Discharges (to intake manifold, other)		Intake Manifold
	Air int.(breather cap, other)		Throttle Body
Evaporative Emission Control	Vapor vented to crankcase, canister, other)	Fuel tank	Canister
		Carburetor	-
	Vapor storage provision		Canister
Electronic System	Closed loop (yes/no)		Yes
	Open loop (yes/no)		No

*FED: One Oxygen Sensor CAL: Two Oxygen Sensors

Engine - Exhaust System

Type (single, single with cross-over, dual, other)		Semi-Dual
Muffler no. & type (reverse flow, straight thru, separate resonator) Material & Mass [kg (weight lbs.)]		1, Straight Flow 1, Reverse Flow
Resonator no. & type		-
Exhaust pipe	Branch o.d., wall thickness	38.6, 1.5mm (1.52, .059 in.)
	Main o.d., wall thickness	48.6, 1.5 mm (1.91, .059 in.)
	Matl. & Mass [kg(wght.lbs.)]	Stainless Steel, 1.5
Intermediate pipe	o.d. & wall thickness	48.6, 1.5 mm; 48.6, 1.6 mm; 48.6, 1.2 mm (1.91, .059 in.; 1.91, .063 in.; 1.91, .047 in.)
	Matl. & Mass [kg(wght.lbs.)]	Stainless 0.3; Aluminum Coated 2.4; Stainless 0.5
Tail pipe	o.d. & wall thickness	31.8, 1.2 mm (1.25, .047 in.)
	Matl. & Mass [kg(wght.lbs.)]	Aluminum Coated Steel, 0.5

MVMA Specifications

Vehicle Line Geo PRIZM
 Model Year 1990 Issued 6-89 Revised(*) 9-89

METRIC (U.S. Customary)

Engine Description
 Engine Code

1.6 LITER L4 (97 CID)
 MULTI-PORT FUEL INJECTION RPO L01

Transmissions/Transaxle (Std., Opt., N.A.)

Manual 3-speed (manufacturer/country)	Not Applicable
Manual 4-speed (manufacturer/country)	"
Manual 5-speed (manufacturer/country)	Standard (Toyota, Japan)
Automatic (manufacturer/country)	Toyota
Auto, overdrive (manufacturer/country)	Not Applicable

Manual Transmission/Transaxle

Number of forward speeds		5
Gear ratios	1st	3.545
	2nd	1.904
	3rd	1.310
	4th	0.969
	5th	0.815
	Reverse	3.250
Synchronous meshing (specify gears)		All Forward Gears
Shift lever location		Floor
Trans. case mat'l. & mass kg (lbs)*		
Lubricant	Capacity [L (pt.)]	2.6
	Type recommended	Multi Purpose API GL-4

Clutch (Manual Transmission)

Clutch manufacturer		AISIN
Clutch type (dry, wet; single, multiple disc)		Dry, Single
Linkage (hyd., cable, rod, lever, other)		Hydraulic
Max. pedal effort (nom. spring load, new) N (lbs.)	Depressed	
	Released	
Assist (spring, power/percent, nominal)		No Adoption
Type pressure plate springs		Diaphragm
Total spring load (nominal, new) N(lbs)		3920 N
Clutch facing	Facing mfr. & mat'l. coding	NISSHIN SPINNING, 31256-12090
	Facing mat'l. & construction	Semi-Mold
	Rivets per facing	16
	Outside x inside dia. (nom.)	200 x 140 mm (7.87 X 5.51 in.)
	Total eff. area [sq cm (sq in)]	160
	Thickness (pressure plate side/fly wheel side)	3.5 mm (.138 in.)
	Rivet depth (pressure plate side/fly wheel side)	4 mm (.157 in.)
	Engagement cushion method	Cushion Spring
Release bearing type & method lub.		Single Row Ball Bearing, Sealed Grease
Torsional damping method, springs, hysteresis		Rubber

* Includes shift linkage, lubricant, and clutch housing. If other specify.

MVMA Specifications

Vehicle Line Geo PRIZM
 Model Year 1990 Issued 6-89 Revised(*) 9-89

METRIC (U.S. Customary)

Engine Description	1.6 LITER L4 (97 CID)
Engine Code	MULTI-PORT FUEL INJECTION RPO LWO

Transmissions/Transaxle (Std., Opt., N.A.)

Manual 3-speed (manufacturer/country)	Not Applicable
Manual 4-speed (manufacturer/country)	"
Manual 5-speed (manufacturer/country)	Standard (Toyota, Japan)
Automatic (manufacturer/country)	AISIN AW
Auto, overdrive (manufacturer/country)	AISIN AW

Manual Transmission/Transaxle

Number of forward speeds	5	
Gear ratios	1st	3.166
	2nd	1.904
	3rd	1.310
	4th	0.969
	5th	0.815
	Reverse	3.250
Synchronous meshing (specify gears)	All Forward Gears	
Shift lever location	Floor	
Trans. case mat'l. & mass kg (lbs)*		
Lubricant	Capacity [L (pt.)]	2.6
	Type recommended	Multi Purpose API GL-4

Clutch (Manual Transmission)

Clutch manufacturer	AISIN	
Clutch type (dry, wet; single, multiple disc)	Dry, Single	
Linkage (hyd., cable, rod, lever, other)	Hydraulic	
Max. pedal effort (nom. spring load, new) N (lbs.)	Depressed	
	Released	
Assist (spring, power/percent, nominal)	No Adoption	
Type pressure plate springs	Diaphragm	
Total spring load (nominal, new) N(lbs)	4410 N	
Clutch facing	Facing mfr. & matl. coding	AISIN CHEMICAL, 31256-17020
	Facing matl. & construction	Semi-Mold
	Rivets per facing	16
	Outside x inside dia. (nom.)	212 x 150 mm (8.35 X 5.91 in.)
	Total eff. area(sq cm(sq in))	176
	Thickness (pressure plate side/fly wheel side)	3.5 mm (.138 in.)
	Rivet depth (pressure plate side/fly wheel side)	4 mm (.157 in.)
	Engagement cushion method	Cushion Spring
Release bearing type & method lub.	Single Row Ball Bearing, Sealed Grease	
Torsional damping method, springs, hysteresis	Rubber	

* Includes shift linkage, lubricant, and clutch housing. If other specify.

MVMA Specifications

Vehicle Line Geo PRIZM
 Model Year 1990 Issued 6-89 Revised(*) 9-89

METRIC (U.S. Customary)

Engine Description
 Engine Code

1.6 LITER L4 (97 CID)
 MULTI-PORT FUEL INJECTION RPO L01

○ Automatic Transmission/Transaxle

Trade Name		A131L
Type and special features (describe)		Hydraulic Controlled Planetary Gear
Gear selector	Location (column, floor, other)	Floor
	Ltr./No. designation (e.g. PRND21)	P-R-N-D-2-L
	Shift interlock (yes, no, describe)	Yes
Gear ratios	1st	2.810
	2nd	1.549
	3rd	1.00
	4th	-
	Reverse	2.296
Max. upshift speed - drive range (km/h (mph))		1 - 2 : 61 2 - 3 : 110
Max. kickdown speed - drive range (km/h (mph))		2 - 1 : 43 3 - 2 : 106
Min. overdrive speed (km/h (mph))		-
Torque converter	Number of elements	3
	Max. ratio at stall	2.3
	Type of cooling (air, liquid)	Water-Cooled
	Nominal diameter	230 mm (9.05 in.)
	Capacity factor "K" ^{**}	-
Lubricant	Capacity (refill L (pt.))	5.5
	Type recommended	ATF Dexron II
Oil cooler (std., opt., N.A., internal, external, air, liquid)		Standard (Water-Cooled)
Trans. mass (kg (lbs)) & case matl. ^{**}		Aluminum Die Cast

○ All Wheel / 4 Wheel Drive

(NOT APPLICABLE)

Desc. & type (part-time, full-time, 2/4 shift while moving, mech., elect., chain/gear, etc.)		
Transfer case	Manufacturer and model	
	Type and location	
Low-range gear ratio		
System disconnect (describe)		
Center differential	Type (bevel, planetary, w or w/o viscous bias, torsen, etc.)	
	Torque split (% frt/rear)	

* Input speed / square root of torque.

** Dry weight including torque converter. If other, specify.

MVMA Specifications

Vehicle Line Geo PRIZM
 Model Year 1990 Issued 6-89 Revised(*) 9-89

METRIC (U.S. Customary)

Engine Description **1.6 LITER L4 (97 CID)**
 Engine Code **MULTI-PORT FUEL INJECTION RPO LWO**

Automatic Transmission/Transaxle

Trade Name		A240E
Type and special features (describe)		Electronic Controlled Planetary Gear
Gear selector	Location (column, floor, other)	Floor
	Ltr./No. designation (e.g. PRND21)	P-R-N-D-2-L
	Shift interlock (yes, no, describe)	Yes
Gear ratios	1st	3.643
	2nd	2.008
	3rd	1.296
	4th	0.892
	Reverse	2.977
Max. upshift speed - drive range [km/h (mph)]		*1 - 2 : 51/63 2 - 3 : 99/114
Max. kickdown speed - drive range [km/h (mph)]		2 - 1 : 46/46 3 - 2 : 92/107
Min. overdrive speed [km/h (mph)]		33
Torque converter	Number of elements	3
	Max. ratio at stall	2.3
	Type of cooling (air, liquid)	Water-Cooled
	Nominal diameter	230 mm (9.05 in.)
	Capacity factor *K [™]	-
Lubricant	Capacity (refill L (pt.))	7.2
	Type recommended	ATF Dexron II
Oil cooler (std., opt., N.A., internal, external, air, liquid)		Standard (Water-Cooled)
Trans. mass [kg(lbs)] & case matl.**		Aluminum Die Cast

* Normal Pattern/Power Pattern

(NOT APPLICABLE)

All Wheel / 4 Wheel Drive

Desc. & type (part-time, full-time, 2/4 shift while moving, mech., elect., chain/gear, etc.)		
Transfer case	Manufacturer and model	
	Type and location	
Low-range gear ratio		
System disconnect (describe)		
Center differential	Type (bevel, planetary, w or w/o viscous bias, torsen, etc.)	
	Torque split(% frt/rear)	

* Input speed / square root of torque.

** Dry weight including torque converter. If other, specify.

MVMA Specifications

Vehicle Line Geo PRIZM
 Model Year 1990 Issued 5-89 Revised(*) 9-89

METRIC (U.S. Customary)

Engine Description	1.6 LITER L4 (97 CID)
Engine Code	MULTI-PORT FUEL INJECTION RPO LO1

Axle Ratio and Tooth Combinations (See 'Power Teams' for axle ratio usage)

Effic. final drv. ratio (or overall top gear ratio)		M/T: 3.72 A/T: 3.53
Trnsfr ratio and method(chain, gear, etc)		
Front drive unit	Ring gear o.d.	- -
	No. of teeth	Pinion M/T: 18 A/T: 19
		Ring gear M/T: 67 A/T: 67

Front Drive Unit

Description (integral to trans., etc.)		Front, Helical Gear
Limited slip differential (type)		-
Drive pinion	Type	Helical Gear
	Offset	-
No. of differential pinions		2
Pinion/ differential	Adjustment (shim, etc.)	-
	Bearing adjustment	
Driving wheel bearing (type)		
Lubricant	Capacity [L (pt.)]	1.4
	Type recommended	ATF Dexron II

Axle Shafts - Front Wheel Drive

Manufacturer and number used		2	
Type (straight, solid bar, tubular, etc.)	Left	Solid Bar	
	Right	Solid Bar	
Outer diam. x length* x wall thickness	Manual transaxle	Left	23.8 x 338 mm (.94 x 13.31 in.)
		Right	23.8 x 633 mm (.94 x 24.92 in.)
	Automatic transaxle	Left	23.8 x 338 mm (.94 x 13.31 in.)
		Right	23.8 x 633 mm (.94 x 24.92 in.)
	Optional transaxle	Left	
		Right	
Slip yoke	Type	-	
	Number of teeth	-	
	Spline o.d.	-	
Universal joints	Make and mfg. no.	Inner	Saginaw Division
		Outer	Saginaw Division
	Number used		4
	Type, size, plunge	Inner	Tripot (Plunging)
		Outer	Rzeppa (Fixed)
	Attach (u-bolt, clamp, etc.)		Snap Ring
Bearing	Type (plain, anti-friction)		
	Lubrication (fitting, prepack)		
Drive taken through (torque tube, arms or springs)			
Torque taken through (torque tube, arms or springs)			

* Centerline to centerline of universal joints, or to centerline of attachment.

MVMA Specifications

Vehicle Line Geo PRIZM
 Model Year 1990 Issued 6-89 Revised(*) 9-89

METRIC (U.S. Customary)

Engine Description **1.6 LITER L4 (97 CID)**
 Engine Code **MULTI-PORT FUEL INJECTION RPO LWO**

Axle Ratio and Tooth Combinations (See 'Power Teams' for axle ratio usage)

Effec. final drv. ratio (or overall top gear ratio)		M/T: 4.31 A/T: 2.96
Trnsfr ratio and method(chain,gear,etc)		
Front drive unit	Ring gear o.d.	- -
	No. of teeth	Pinion M/T: 16 A/T: 27
	Ring gear	M/T: 69 A/T: 80

Front Drive Unit

Description (integral to trans., etc.)		Front, Helical Gear
Limited slip differential(type)		-
Drive pinion	Type	Helical Gear
	Offset	-
No. of differential pinions		2
Pinion/differential	Adjustment (shim, etc.)	-
	Bearing adjustment	
Driving wheel bearing (type)		
Lubricant	Capacity [L (pt.)]	1.4
	Type recommended	ATF Dexron II

Axle Shafts - Front Wheel Drive

Manufacturer and number used		2	
Type (straight, solid bar, tubular, etc.)	Left	Solid Bar	
	Right	Solid Bar	
Outer diam. x length * x wall thickness	Manual transaxle	Left	23.8 x 338 mm (.94 x 13.31 in.)
		Right	23.8 x 633 mm (.94 x 24.92 in.)
	Automatic transaxle	Left	23.8 x 338 mm (.94 x 13.31 in.)
		Right	23.8 x 633 mm (.94 x 24.92 in.)
	Optional transaxle	Left	
		Right	
Slip yoke	Type	-	
	Number of teeth	-	
	Spline o.d.	-	
Universal joints	Make and mfg. no.	Inner	Saginaw Division
		Outer	Saginaw Division
	Number used		4
	Type, size, plunge	Inner	Tripot (Plunging)
		Outer	Rzeppa (Fixed)
	Attach (u-bolt, clamp, etc.)		Snap Ring
Bearing	Type (plain, anti-friction)		
	Lubrication (fitting, prepack)		
Drive taken through (torque tube, arms or springs)			
Torque taken through (torque tube, arms or springs)			

* Centerline to centerline of universal joints, or to centerline of attachment.

MVMA Specifications

Vehicle Line Geo PRIZM
 Model Year 1990 Issued 6-89 Revised(*) 9-89

METRIC (U.S. Customary)

Body Type And/Or

Engine Displacement

Geo PRIZM

Geo PRIZM GSI

Suspension - General Including Electronic Controls

Car leveling	Std./opt./not avail.	Not	
	Manual/automatic control	Available	
	Type (air/hydraulic)		
	Primary/assist spring		
	Rear only/4 wheel leveling		
	Single/dual rate spring		
	Single/dual ride heights		
Shock absorber damping controls	Standard/option/not avail.	Not	
	Manual/automatic control	Available	
	Number of damping rates		
	Type of actuation (manual/electric motor/air, etc.)		
	s e n s o r s	Lateral acceleration	
		Deceleration	
		Acceleration	
Road surface			
Shock absorber (front & rear)	Type	Twin Tube	
	Make	DELCO/KAYABA TOYOTA/KAYABA	
	Piston diameter	Front: 32.0 mm (1.26 in.); Rear: 30.2 mm (1.19 in.)	
	Rod diameter	Front: 20.0 mm (.79 in.); Rear: 20.0 mm (.79 in.)	

Suspension - Front

Type and description		MacPherson Strut	
Travel*	Full jounce	80.0 mm (3.15 in.)	
	Full rebound	85.0 mm (3.35 in.)	82.0 mm (3.23 in.)
Spring	Type (coil, leaf, other) & matl	Coil SUP 7NV	
	Insulators (type & matl)	Upper & Lower, Rubber	
	Size (coil design height & i.d.)	(1)	(2)
	Spring rate (N/mm (lb./in.))	19.6 (S/D), 22.5 (L/B)	19.6
	Rate @ wheel (N/mm (lb./in.))	19.6 (S/D), 22.5 (L/B)	19.6
Stabilizer	Type (link, linkless, frmlless)	Not Available Link	
	Material & bar diameter	" STKM 15A 24.0mm (.94 in.)	

Suspension - Rear

Type and description		Macpherson Strut	
Travel*	Full jounce	85.0 mm (3.35 in.)	
	Full rebound	95.0 mm (3.74 in.)	83.0mm (3.27 in.)
Spring	Type (coil, leaf, other) & matl	Coil SUP 7	
	Size (length x width, coil design height & i.d.)	337.0 x (88.8 To 118.8)	320.0 x (88.7 To 118.7)
		343.0 x (88.7 To 118.7)*1	325.0 x (88.6 To 118.6)*1
	Spring rate (N/mm (lb/in))	17.6	19.6
	Rate @ wheel (N/mm (lb/in))	17.6	19.6
	Insulators (type & material)	Upper & Lower Rubber	
	if leaf	No. of leaves	-
Shackle (comp or tens)		-	
Stabilizer	Type (link, linkless, frmlless)	Link	
	Material & bar diameter	SUP 6, 14 mm (.55 in.)	SUP 6, 15mm (.59 in.)
Track bar (type)			

* Define load condition:

*1: L/B

MVMA Specifications

Vehicle Line Geo PRIZM
Model Year 1990 Issued 6-89 Revised(*) 9-89

METRIC (U.S. Customary)

SUPPLEMENTAL PAGE

(1) Geo PRIZM

		RH		LH	
		W/O A/C	W/AC	W/O A/C	W/AC
S/D	M/T	348.0 x 127.7	355.5 x 127.6	355.5 x 127.6	363.0 x 127.5
S/D	A/T	355.5 x 127.6	363.0 x 127.5	363.0 x 127.5	370.5 x 127.3
L/B	M/T	326.5 x 127.5	333.0 x 127.4	333.0 x 127.4	339.5 x 127.3
L/B	A/T	333.0 x 127.4	339.5 x 127.3	339.5 x 127.3	346.0 x 127.1

(2) Geo PRIZM GSI

		RH		LH	
		W/O A/C	W/AC	W/O A/C	W/AC
L/B	M/T	355.5 x 127.6	363.0 x 127.5	363.0 x 127.5	370.5 x 127.3
L/B	A/T	370.5 x 127.3	378.0 x 127.2	378.0 x 127.2	385.5 x 127.4

MVMA Specifications

Vehicle Line Geo PRIZM
 Model Year 1990 Issued 6-89 Revised(*) 9-89

METRIC (U.S. Customary)

Body Type And/Or

Engine Displacement

Geo PRIZM	Geo PRIZM GSI
-----------	---------------

Brakes - Service

Description				
Manufacturer and brake type (std., opt., n.a.)	Front (disc or drum)	Disc, Standard		
	Rear (disc or drum)	Drum, Standard	Disc, Standard	
Valving type(prop, delay, metering, other)		Proportioning		
Power brake (std., opt., n.a.)		Standard		
Booster type(rmt, intgrl, vac., hyd., etc.)		Direct Vacuum		
Vacuum	Source (inline, pump, etc.)	Not Available		
	Reservoir (volume cu. in.)	"		
	Pump-type	"		
Traction Control	Operational speed range	"		
	Type engine intervention	"		
Anti-lock device	Front/rear (std., opt., n.a.)	"		
	Manufacturer	"		
	Type (electronic, mech.)	"		
	Number sensors or circuits	"		
	No. anti-lock hyd. circuits	"		
	Integral or add-on system	"		
	Yaw control (yes, no)	"		
Hydraulic power source		"		
Effective area (sq. cm. (sq. in.))*		164/232	164/132	
Gross Lng area (sq cm (sq in))**(F/R)		164/232	164/132	
Swept area (sq cm (sq in))*** (F/R)				
Rotor	Outer working diameter	F/R	238 mm/--- 258 mm/242 mm	
	Inner working diameter	F/R	142 mm/--- 162 mm/166 mm	
	Thickness	F/R	18.0 mm/--- 22 mm/9 mm	
	Matl & type (vented/sld)	F/R	Cast Iron Vented/--- Cast Iron Vented/Cast Iron Solid	
Drum	Diameter & width	F/R	---/200.0 mm ---/---	
	Type and material	F/R	---/Cast Iron ---/---	
Wheel cylinder bore		51.1 mm (2.01 in.)/17.46 mm (.69 in.) 54.0 mm (2.13 in.)/30.16 mm (1.19 in.)		
Master cylinder	Bore/stroke	F/R	20.64 mm/14.0 + 14.0 mm 22.22 mm/14.0 + 14.0 mm	
Pedal arc ratio		4.15		
Line pressure at 445 N (100 lb.) pedal load (kPa (psi))		11126 9690		
Lining clearance		F/R	Self-Adjusting	
Brake lining	Front wheel	Bonded or riveted	Bonded	
		Rivet size		
		Manufacturer	Bendix, Nisshinbo, Akebono, Aisin, Sumitomo	
		Lining code *****		
		Material	Resin Molded	
		**** Pri. or out-brd	104 x 42 x 10 mm (4.09 x 1.65 x .394 in.)	
		**** Size Sec. or in-brd	104 x 42 x 10 mm (4.09 x 1.65 x .394 in.)	
	Shoe thcknss.(no lng)	5.0 mm (.039 in.)		
	Rear wheel	Bonded or riveted	Bonded	
		Manufacturer	Nisshinbo, Akebono	
		Lining code *****		
		Material	Resin Molded	
		**** Pri. or out-brd	192 x 30 x 4 mm (7.56 x 1.18 x .157 in.)	95 x 34 x 10mm(3.74 x 1.34 x .394 in.)
		**** Size Sec. or in-brd	192 x 30 x 4 mm (7.56 x 1.18 x .157 in.)	95 x 34 x 10mm(3.74 x 1.34 x .394 in.)
Shoe thcknss (no lng)		1.6 mm (.063 in.)	5.5 mm (.216 in.)	

* Excludes rivet holes, grooves, chamfers, etc. **Includes rivet holes, grooves, chamfers, etc.
 *** Total swept area for four brakes. (Drum brake: Widest lining contact width for each brake x its contact circum.)
 (Disc brake: Square of Outer Working Dia. - Square of Inner Working Dia. X Pi/2 for each brake.)
 **** Size for drum brakes includes length x width x thickness.
 ***** Manufacturer I.D., catalog for formulation designation and coefficient of friction classification.

MVMA Specifications

Vehicle Line Geo PRIZM
 Model Year 1990 Issued 6-89 Revised(*) 9-89

METRIC (U.S. Customary)

Body Type And/Or
 Engine Displacement

Geo PRIZM	Geo PRIZM GSI
-----------	---------------

Tires And Wheels (Standard)

Tires	Size (load range, ply)	P175/70R13	P185/60HR14	
	Type (bias, radial, etc.)	Radial		
	Inflation pressure (cold) for recommended max. vehicle load	Front [kPa(psi)]	200	221
		Rear [kPa(psi)]	200	221
	Rev/mile—at 70 km/h(45mph)	927	925	
Wheels	Type & material	*1 Steel	Aluminum	
	Rim (size & flange type)	5-J x 13	14 x 5 1/2 - JJ	
	Wheel offset	45.0 mm (1.77 in.)	39.0 mm (1.53)	
	Attachment	Type(bolt,stud)	Nut	
		Circle diameter	100.0 mm (3.94 in.)	
Number & size		4:12 P=1.5		
Spare	Tire and wheel	T115/70D14 4T x 14		
	Storage position & location (describe)	Luggage Room		

*1: Wide R/M With Deep Bottom

Tires And Wheels (Optional)

Tire size (load range, ply)	
Type (bias, radial, steel, nylon, etc.)	
Wheel (type & material)	
Rim (size, flange type and offset)	
Tire size (load range, ply)	
Type (bias, radial, steel, nylon, etc.)	
Wheel (type & material)	
Rim (size, flange type and offset)	
Tire size (load range, ply)	
Type (bias, radial, steel, nylon, etc.)	
Wheel (type & material)	
Rim (size, flange type and offset)	
Tire size (load range, ply)	
Type (bias, radial, steel, nylon, etc.)	
Wheel (type & material)	
Rim (size, flange type and offset)	
Spare tire and wheel size	
(if configuration is different than road tire or wheel, describe optional spare tire and/or wheel location & storage position)	

Brakes - Parking

Type of control	Hand Operate Type	
Location of control	Center Floor	
Operates on	Rear Brake	
If separate from service brakes	Type(internal or external)	--
	Drum diameter	--
	Lining size (length x width x thickness)	--

MVMA Specifications

Vehicle Line Geo PRIZM
 Model Year 1990 issued 6-89 Revised(*) 9-88

METRIC (U.S. Customary)

Body Type And/Or
 Engine Displacement

Geo PRIZM

Geo PRIZM GSI

Steering

Manual (std., opt., n.a.)		Standard	Not Applicable	
Power (std., opt., n.a.)		Optional	Standard	
Adjustable steering wheel/ column (tilt, telescope, other)	Type	Tilt		
	Manufacturer	Toyota Motor Corporation		
	(std., opt., n.a.)	Optional	Standard	
Wheel diameter ** (W9) SAE J1100	Manual	380 mm (14.96 in.)	384 mm (15.12 in.)	
	Power	380 mm (14.96 in.)	384 mm (15.12 in.)	
Turning diameter m (ft.)	Out-side front	Wall to wall (l. & r.)	10.6 (10.8) () :PS	
		Curb to curb (l. & r.)	9.6 (9.8)	
	In-side rear	Wall to wall (l. & r.)	5.2 (5.4)	
		Curb to curb (l. & r.)	5.4 (5.6)	
Scrub Radius *		0.6	7.1	
Manual	Gear	Type	R & P	
		Manufacturer	Toyota Motor Corporation	
		Ratios	Gear	
			Overall	24.1
	No. wheel turns(stop to stop)		4.3	
Power	Type (hydraulic, elec., etc.)		Integral	
	Manufacturer		Toyota Motor Corporation	
	Gear	Type	R & P	
		Ratios	Gear	
			Overall	19.1
	Pump (drive)		V-Ribbed Belt	
No. wheel turns(stop to stop)		3.4		
Linkage	Type		Ackermann	
	Location (front or rear of wheels, other)		Rear Of Wheels	
	Tie Rods (one or two)		2	
Steering axis	Inclination at camber (deg.)		12 deg. 40' *1 12 deg. 45' *2 12 deg. 50'	
	Bear-ings (type)	Upper	Ball Bearing	
		Lower	Ball Joint	
		Thrust	-	
Steering spindle/knuckle & joint type				
Wheel spindle/ hub	Dia-meter	Inner bearing	38	
		Outer bearing	72	
	Thread (size)		M19 x 1.5	
	Bearing (type)		Double Row Angular Ball	

* The horizontal distance in the front elevation between wheel centerline and kingpin (ball joint) axis at ground.

** See Page 22.

*1: AT *2: MT

MVMA Specifications

Vehicle Line Geo PRIZM
 Model Year 1990 Issued 6-89 Revised(*) 9-89

METRIC (U.S. Customary)

Body Type And/Or
 Engine Displacement

Geo PRIZM	Geo PRIZM GSI
A/T	M/T

Wheel Alignment

Wheel	Service	Parameter	Geo PRIZM	Geo PRIZM GSI
Front wheel at curb mass (wt.)	Service checking	Caster (deg.)	1 20' (+/-) 45'	1 25' (+/-) 45'
		Camber (deg.)	-0 10' (+/-) 45'	-0 15' (+/-) 45'
		Toe-in (outside track-mm (in.))	1 (+/-) 4	
	Service reset*	Caster (deg.)	1 20' (+/-) 30'	1 25' (+/-) 30'
		Camber (deg.)	-0 10' (+/-) 30'	-0 15' (+/-) 30'
		Toe-in (deg.)	1 (+/-) 1	
	Periodic M.V. inspection	Caster (deg.)	1 20' (+/-) 45'	1 25' (+/-) 45'
		Camber (deg.)	-0 10' (+/-) 45'	-0 15' (+/-) 45'
		Toe-in (deg.)	1 (+/-) 4	
Rear wheel at curb mass (wt.)	Service checking	Camber (deg.)	0 35' (+/-) 45'	-0 40' (+/-) 45'
		Toe-in (outside track-mm (in.))	4 (+/-) 4	
	Service reset*	Camber (deg.)	-0 35' (+/-) 30'	-0 40' (+/-) 30'
		Toe-in (deg.)	4 (+/-) 2	
	Periodic M.V. inspection	Camber (deg.)	-0 35' (+/-) 45'	-0 40' (+/-) 45'
		Toe-in (deg.)	4 (+/-) 4	

* Indicates pre-set, adjustable, trend set or other.

Electrical - Instruments and Equipment

Speed-ometer	Type (analog, digital, std., opt.)	Analog, Round
	Trip odometer (std., opt., n.a.)	Standard
EGR maintenance indicator		Not Available
Charge indicator	Type	Tell-Tale Warning Light
	Warning device (light, audible)	Light
Temperature indicator	Type	Needle
	Warning device	Not Available
Oil pressure indicator	Type	Tell-Tale Warning Light
	Warning device	Light
Fuel indicator	Type	Needle
	Warning device	Tell-Tale Warning Light
Wind-shield wiper	Type (standard)	Motor, 2-Step With Mist
	Type (optional)	Motor, 3-Step Variable
	Blade length	*500 mm/450mm
	Swept area (sq cm (sq in))	6340
Wind-shield washer	Type (standard)	Motor
	Type (optional)	-
	Fluid level indicator	Not Available
Rear window wiper, wiper/washer (std., opt., n.a.)		Sedan: Not Available Liftback: Optional (Base), Standard (GSI)
Horn	Type	Electric, Disc Type
	Number used	1
Other		

*: Dr./Pa.

MVMA Specifications

Vehicle Line Geo PRIZM
 Model Year 1990 Issued 6-89 Revised(*) 9-89

METRIC (U.S. Customary)

Engine Description	1.6 LITER L4 (97 CID)
Engine Code	MULTI-PORT FUEL INJECTION RPO L01

Electrical - Supply System

Battery	Manufacturer	Delco Remy
	Model, std., (opt.)	55D23L
	Voltage	12
	Amps at 0 deg F cold crnk	310
	Minutes-reserve capacity	90
	Amps/hrs. - 20 hr. rate	60
	Location	Left Front in Engine Compartment
Alternator	Manufacturer	
	Rating (idle/max. rpm)	1:2.36
	Ratio (alt. crank/rev.)	
	Output at idle (rpm, park)	
Optional (type & rating)		
Regulator	Type	IC Type

Electrical - Starting System

Motor	Manufacturer	NIPPONDENSO CO., LTD.
	Current drain deg F	-
	Power rating [kw (hp)]	
Motor drive	Engagement type	Shift Type
	Pinion engages from (front, rear)	Right

Electrical - Ignition System

Type	Electronic (std, opt, n.a.)	Standard	
	Other (specify)	Not Applicable	
Coil	Manufacturer	NIPPONDENSO CO., LTD.	
	Model	-	
	Current	Engine stopped - A	0 A
		Engine idling - A	0.7 A
Spark plug	Manufacturer	NIPPONDENSO, NGK SPARK PLUG	
	Model	Q16R-U. BCPR5EY	
	Thread (mm)	M14-19.0	
	Tightening torque (Newton meters (lb. ft.))	17.7	
	Gap	0.8 mm (.031 in.)	
	Number per cylinder	1	
Distributor	Manufacturer	NIPPONDENSO CO., LTD.	
	Model	-	

Electrical - Suppression

Locations & type	Resistive Cord, Resistive Spark Plug
------------------	---

MVMA Specifications

Vehicle Line Geo PRIZM
 Model Year 1990 Issued 6-89 Revised(*) 9-89

METRIC (U.S. Customary)

Engine Description
 Engine Code

1.6 LITER L4 (97 CID)
 MULTI-PORT FUEL INJECTION RPO LWO

Electrical - Supply System

Battery	Manufacturer	Delco Remy
	Model, std., (opt.)	55D23L
	Voltage	12
	Amps at 0 deg F cold crnk	310
	Minutes-reserve capacity	90
	Amps/hrs. - 20 hr. rate	60
	Location	Left Front In Engine Compartment
Alternator	Manufacturer	
	Rating (idle/max. rpm)	1:2.36
	Ratio (alt. crank/rev.)	
	Output at idle (rpm, park)	
	Optional (type & rating)	
Regulator	Type	IC Type

Electrical - Starting System

Motor	Manufacturer	NIPPONDENSO CO., LTD.
	Current drain deg F	-
	Power rating [kw (hp)]	
Motor drive	Engagement type	Shift Type
	Pinion engages from (front, rear)	Right

Electrical - Ignition System

Type	Electronic (std, opt, n.a.)	Standard	
	Other (specify)	Not Applicable	
Coil	Manufacturer	NIPPONDENSO CO., LTD.	
	Model	-	
	Current	Engine stopped - A	0 A
		Engine idling - A	0.9 A
Spark plug	Manufacturer	NIPPONDENSO, NGK SPARK PLUG	
	Model	PK20R8 BRP6EP8	
	Thread (mm)	M14-19.0	
	Tightening torque [Newton meters (lb. ft.)]	17.7	
	Gap	0.8 mm (.031 in.)	
	Number per cylinder	1	
Distributor	Manufacturer	NIPPONDENSO CO., LTD.	
	Model	-	

Electrical - Suppression

Locations & type	Flame Spray Coating Rotor Resistive Spark Plug Resistive Cord
------------------	---

MVMA Specifications

Vehicle Line Geo PRIZM
 Model Year 1990 Issued 6-89 Revised(*) 9-89

METRIC (U.S. Customary)

Body Type

ALL

Body

Structure	Monocoque			
Bumper System Front - Rear	Bar Material & Mass	Urethane (Cover)	FR	RR
			5.1 kg	5.1 kg 4.8 kg
	Reinforcement Material & Mass	Polyethylene (Absorber)	1.9 kg	2.3 kg 2.3 kg
		Steel	9.8 kg	11.7 kg 13.3 kg
		Sedan, Liftback	Sedan Liftback	
Anti-Corrosion Treatment	Adoption Of Galvannealed Steel Sheet Application Of Adhesive & PVC Sealer To The Hemming Area Application of PVC Under Coat CATHODIC ED Stone Guard Coat Full Dipping Pretreatment			

Body - Miscellaneous Information

Type of finish (lacquer, enamel, other)	Acryl	
Hood	Material & mass	Steel, 14630 g
	Hinge location (front, rear)	Rear
	Type (counterbalance, prop)	Prop
	Release control (int., ext.)	Internal
Trunk lid	Material & mass	Steel, 8000 g
	Type (counterbalance, other)	Counterbalance
	Internal release control (elec., mech., n.a.)	Base: Not Applicable GSI: Mechanical (Optional)
Hatch-back lid	Material & mass	Steel, 13000 g
	Type (counterbalance, other)	Counterbalance
	Internal release control (elec., mech., n.a.)	Base: Not Applicable GSI: Mechanical (Optional)
Tailgate	Material & mass	
	Type (drop, lift, door)	
	Internal release control (elec., mech., n.a.)	
Vent window control (crank, friction, pivot, power)	Front	-
	Rear	-
Window regulator type (cable, tape, flex drive, etc.)	Front	Drive
	Rear	Drive
Seat cushion type (e.g., 60/40, bucket, bench wire, foam, etc.)	Front	Panel Frame + Foam Pad
	Rear	Wire Frame + Foam Pad
	3rd seat	-
Seat back type (e.g., 60/40, bucket, bench, wire, foam, etc.)	Front	Pipe Frame + Spring + Foam Pad
	Rear	Wire Frame + Foam Pads *1, Panel Frame & Foam Pad *2
	3rd seat	

MVMA Specifications

Vehicle Line Geo PRIZM
 Model Year 1990 Issued 6-89 Revised(*) 9-89

METRIC (U.S. Customary)

Body Type

ALL

Restraint System

Seating Position			Left	Center	Right
Active	Type & description (lap & shoulder belt, lap belt, etc.)	First seat			
		Second seat	3-Point ELR	2-Point	3-Point ELR
	Standard/optional	Third seat			
Passive	Type & description (air bag, motorized-2-point belt, fixed belt, knee bolster, manual-lap belt)	First seat	Non-Motorized 2-Pt. Belt W/ELR + Lap Belt W/ALR, & Knee Bolster - Std.		Non-Motorized 2-Pt. Belt W/ELR + Lap Belt W/ALR, & Knee Bolster - Std.
		Second seat			
	Standard/optional	Third seat			

Glass

	SAE Ref No	
Windshield glass exposed surface area [sq. cm. (sq. in.)]	S1	8729
Side glass exposed surface area [sq. cm. (sq. in.)] - total 2-sides	S2	10641 (Sedan); 12133 (Liftback)
Backlight glass exposed surface area [sq. cm. (sq. in.)]	S3	7509 (Sedan); 7680 (Liftback)
Total glass exposed surface area [sq. cm. (sq. in.)]	S4	26879 (Sedan); 28542 (Liftback)
Windshield glass (type)		Laminated Glass
Side glass (type)		Tempered Glass
Backlight glass (type)		Tempered Glass

Headlamps

Description - sealed beam, halogen, replaceable bulb, etc.	Replaceable Bulb
Shape	Aero-Dynamically Sculptured
Lo-beam type (2A1, 2B1, 2C1, etc.)	Replaceable Bulb Type
Quantity	2
Hi-beam type (1A1, 2A1, 1C1, 2C1, etc.)	Not Applicable
Quantity	Not Applicable

Frame

Type and description (separate frame, unitized frame, partially-unitized frame)	Monocoque
---	-----------

MVMA Specifications

Vehicle Line Geo PRIZM
 Model Year 1990 Issued 6-89 Revised(*) 9-89

METRIC (U.S. Customary)

Body Type

ALL

Convenience Equipment (standard, optional, n.a.)

Air conditioning (manual, auto, temp control)	Optional	
Clock (digital, analog)	Optional (BASE) Standard (GSI)	
Compass / thermometer	Not Available	
Console (floor, overhead)	Standard (Floor)	
Defroster, elec. backlight	Standard	
Electronic	Diagnostic monitor (integrated, individual)	Not Available
	Instrument cluster (list instruments)	Not Available
	Keyless entry	"
	Tripminder (avg. spd. fuel)	"
	Voice alert (list items)	"
	Other	"
Fuel door lock (remote, key, electric)	Standard (Remote)	
Lamps	Auto head on/off delay, dimming	Not Available
	Cornering	"
	Courtesy (map, reading)	Optional (With Sunroof)
	Door lock, ignition	Not Available
	Engine compartment	"
	Fog	"
	Glove compartment	"
	Trunk	Optional
	Illuminated entry system (list lamps, activation)	Not Available
	Other	"
Mirrors	Day / night (auto. man.)	Standard (Manual)
	L.H. (remote, pwr., heated)	Standard (Remote), Standard (Convex: BASE), Standard (Remote: GSI)
	R.H.(convex, rmt, pwr, htd)	Standard (Convex), Standard (Convex: GSI), Optional (Convex: BASE)
	Visor vanity (RH/LH illum.)	Not Available (BASE), Optional (GSI)
Navigation system (describe)	Not Available	
Prkg. brake-auto release (warn. light)	Not Available (Only Warning Light)	

MVMA Specifications

Vehicle Line Geo PRIZM
 Model Year 1990 Issued 6-89 Revised(*) 9-89

METRIC (U.S. Customary)

Engine Description
 Engine Code

ALL

Convenience Equipment (standard, optional, n.a.)

Power equipment	Deck lid(release, pull down)		Not Available	
	Door locks (manual, auto., describe system)		Optional (Manual)	
	Seats	2 - 4 - 6 way, etc.		Not Available
		Reclining(R.H., L.H.)		"
		Memory (R.H., L.H., preset, recline)		"
		Lumbar, hip, thigh, support		"
		Heated (R.H., L.H., other)		"
	Side windows		Optional (GSI), Not Available (BASE)	
	Vent windows		Not Available	
	Rear windows		"	
Radio systems	Antenna (location, whip, w/shield, power)		Roof	
	Stan.	AM, FM, stereo, tape, compact disc, graphic equalizer, theft deterrent, radio prep package, headphone jacks, etc.	AM/FM MPX ETR [Standard (GSI), Optional (BASE)]	
	Opt.		AM/FM MPX ETR With Cassette Deck	
	Speaker (number, location)		4	
Roof: open air or fixed (flip-up, sliding, 'T')			Optional (Sliding)	
Speed control device			Optional	
Speed warn. dev. (light, buzzer, etc.)			Not Available	
Tachometer (rpm)			Not Available (BASE), Standard (GSI)	
Telephone system (describe)			Not Available	
Theft deterrent system			Steering Lock	

MVMA Specifications

Vehicle Line Geo PRIZM
 Model Year 1990 Issued 6-89 Revised(*) 9-89

METRIC (U.S. Customary)

Vehicle Dimensions See Key Sheets for definitions

All dimensions to ground are for comparative purposes only. Dimensions are to be shown for all base body models of each vehicle line. SAE Ref. no. refers to the definition published in SAE Recommended Practice J1100 'Motor Vehicle Dimensions,' unless otherwise specified.

Body Type

Geo PRIZM	Geo PRIZM GSI
-----------	---------------

Width

	SAE Ref. No.		
Tread (front)	W101	1430 (56.3)	1445 (56.9)
Tread (rear)	W102	1410 (55.5)	1425 (56.1)
Vehicle width	W103	1655 (65.2)	
Body width at Sg RP (front)	W117	1615 (63.6)	
Vehicle width (front doors open)	W120	3325 (130.9)	
Vehicle width (rear doors open)	W121	3195 (125.8)	
Tumble-home (deg.)	W122	24	
Outside mirror width	W410	1850 (72.8)	

Length

Wheelbase	L101	2430 (95.7)	
Vehicle length	L103	4335 (170.7)	
Overhang (front)	L104	885 (34.8)	
Overhang (rear)	L105	1020 (40.2)	
Upper structure length	L123	2599 (102.3) [S/D] 2824 (112) [L/B]	
Rear wheel C/L 'X' coordinate	L127	2430 (95.7)	

Height **

Passenger distribution (front/rear)	PD1,2,3	2/1	**
Trunk/cargo load			**
Vehicle height	H101	1330 (52.4)	
Cowl point to ground	H114	870 (34.2)	
Deck point to ground	H138	935 (36.8) [S/D] 920 (36.2) [L/B]	
Rocker panel-front to ground	H112	180 (7.1)	
Rocker panel-rear to ground	H111	185 (7.3)	
Windshield slope angle (deg.)	H122	59	
Backlight slope angle (deg.)	H121	59 [S/D] 65 [L/B]	

Ground Clearance **

Front bumper to ground	H102	230 (9.0)	
Rear bumper to ground	H104	270 (10.6)	
Bumper to ground (front at curb mass (wt.))	H103	250 (9.8)	240 (9.4)
Bumper to ground (rear at curb mass (wt.))	H105	315 (12.4)	305 (12.0)
Angle of approach (deg.)	H106	17.0	
Angle of departure (deg.)	H107	15.5	14.0
Ramp breakover angle (deg.)	H147	12.0	12.5
Axle differential to ground (front/rear)	H153	-	
Min. running ground clearance	H158	140 (5.5)	
Location of min. run. grd. clear.		Center Pipe	

** All Vehicle Height And Ground Clearance Are Made Using EPA Loaded Vehicle Weight, Loading Conditions.

EPA Loaded Vehicle Weight is the Base Vehicle Weight Plus All Coolant and Fluids Necessary For Operation Plus 100% Of The Fuel Capacity, Plus The Weight Of All Options And Accessories Which Weigh Three Pounds Or More And Which Are Sold On At Least 33% Of The Car Line, Plus Two Occupants.

All Linear Dimensions Are In Millimeters (Inches).

MVMA Specifications

Vehicle Line Geo PRIZM
 Model Year 1990 Issued 6-89 Revised(*) 9-89

METRIC (U.S. Customary) Vehicle Dimensions

See Key Sheets for Definitions

Body Type

4-DOOR NOTCHBACK

4-DOOR HATCHBACK

○ Front Compartment

SAE Ref. No.

	SAE Ref. No.	
SgRP front, 'X' coordinate	L31	1325 (52.2)
Effective head room	H81	972.5 (38.3) / 942.4 (37.1) (1) 973.2 (38.3)/942.4 (37.1)(1)
Max. eff. leg room (accelerator)	L34	1038 (40.9)
SgRP to heel point	H30	267.5 (10.5)
SgRP to heel point	L53	819.5 (32.3)
Back angle (deg.)	L40	17
Hip angle (deg.)	L42	86
Knee angle (deg.)	L44	118
Foot angle (deg.)	L46	87
Design H-point front travel	L17	LH 209 (8.2); RH 194 (7.6)
Normal driving & riding seat track trvl.	L23	LH 209 (8.2); RH 194 (7.6)
Shoulder room	W3	1351 (53.2)
Hip room	W5	1261 (49.6)
*** Upper body opening to ground	H50	1225 (48.2) / 1224 (48.2) (2)
Steering wheel maximum diameter*	W9	
Steering wheel angle (deg.)	H18	
Accel. heel pt. to steer. whl. cntr	L11	
Accel. heel pt. to steer. whl. cntr	H17	
Undepressed floor covering thickness	H67	8 (0.3)

Front Compartment Int. Dim. Are Measured With The Seating Ref. Pt.
 (SgRP) mm Forward And mm Upward of Rearmost Position.

○ Rear Compartment

(SgRP) mm Forward And mm Upward of Rearmost Position.

	SAE Ref. No.	
SgRP point couple distance	L50	720 (28.3)
Effective head room	H83	917.5 (36.1) / 917 (36.1) (1) 901.4 (35.5)/905.1 (35.6)(1)
Min. effective leg room	L51	803 (31.6)
SgRP (second to heel)	H31	305 (12.0)
Knee clearance	L48	60 (2.4)
Shoulder room	W4	1339 (52.7)
Hip room	W6	1328 (52.3)
*** Upper body opening to ground	H51	1229.8 (48.4) / 1228.8 (48.4) (2)
Back angle (deg.)	L41	27
Hip angle (deg.)	L43	84.5
Knee angle (deg.)	L45	73.5
Foot angle (deg.)	L47	114
Depressed floor covering thickness	H73	8 (0.3)

Luggage Compartment

Usable luggage capacity (L. cu. ft.)	V1	0.34 (12.0)
*** Liftover height	H195	565 (22.2) 580 (22.8)

Interior Volumes (EPA Classification)

Vehicle class		
		Subcompact
Interior volume index (cu. ft.)**		94.1 99.7
Trunk / cargo index (cu. ft.)		11.2 17.3

* See page 14.
 ** Includes passenger and trunk / cargo index - see definition page 32.

*** EPA Loaded Vehicle Weight, Loading Conditions

All Linear Dimensions Are in Millimeters (Inches).

(1) - Sun Roof (Optional)

(2) - GT

MVMA Specifications

Vehicle Line Geo PRIZM
 Model Year 1990 Issued 6-89 Revised(*) _____

METRIC (U.S. Customary) Vehicle Dimensions

See Key Sheets for Definitions

Body Type

4-DOOR NOTCHBACK

4-DOOR HATCHBACK

Station Wagon - Third Seat

SAE Ref. No. (NOT APPLICABLE)

	SAE Ref. No.	(NOT APPLICABLE)
Seat facing direction	SD1	
SgRP couple distance	L85	
Shoulder room	W85	
Hip Room	W86	
Effective leg room	L86	
Effective head room	H86	
SgRP to heel point	H87	
Knee clearance	L87	
Back angle	L88	
Hip angle	L89	
Knee angle	L90	
Foot angle	L91	

Station Wagon - Cargo Space

(NOT APPLICABLE)

	SAE Ref. No.	(NOT APPLICABLE)
Cargo length (open front)	L200	
Cargo length (open second)	L201	
Cargo length (closed front)	L202	
Cargo length (closed second)	L203	
Cargo length at belt (front)	L204	
Cargo length at belt (second)	L205	
Cargo width (wheelhouse)	W201	
Rear opening width at floor	W203	
Opening width at belt	W204	
* Min. rear opening width above belt	W205	
Cargo height	H201	
Rear opening height	H202	
Tailgate to ground height	H250	
Front seat back to load floor height	H197	
Cargo volume index [cu. m.(cu.ft.)]	V2	
Hidden cargo vol. index [cu.m.(cu.ft.)]	V4	
Cargo volume index-rear of 2-seat	V10	

Hatchback - Cargo Space

	SAE Ref. No.	Value
Cargo length at front seatback height	L208	1408.4 (55.4)
Cargo length at floor (front)	L209	1684.2 (66.3)
Cargo length at second seatback height	L210	435.9 (17.2)
Cargo length at floor (second)	L211	965.1 (38.0)
Front seatback to load floor height	H197	439.8 (17.3)
Second seatback to load floor height	H198	520.6 (20.5)
Cargo volume index [cu. m. (cu. ft.)]	V3	0.911 (32.2)
Hidden cargo vol. index [cu.m.(cu.ft.)]	V4	0.488 (17.2)
Cargo volume index-rear of 2-seat	V11	0.488 (17.2)

* EPA Loaded Vehicle Weight, Loading Conditions
 All Linear Dimensions Are in Millimeters (Inches)

MVMA Specifications

Vehicle Line Geo PRIZM
 Model Year 1990 Issued 6-89 Revised(**) _____

METRIC (U.S. Customary)

Body Type

ALL MODELS

Vehicle Fiducial Marks

Number*	Define Coordinate Location	
Front	Center Of Installation Hole For Seat Track Outer Of Seat Track Of Front Floor (Both Side)	
Rear	Center Of Installation Hole On Front Side For Rear Seat-Belt Retractor Of Rear Center Floor (Both Side)	
Fiducial Mark Number		
Front	W21*	W5 + 70.5 mm
	L54*	L19 + 90 mm
	H81*	H10 + 73.5 mm
	H161*	290 mm
	** H163*	260 mm
Rear	W22*	W5 + 4.5 mm
	L55*	L30 + 34 mm
	H82*	350 mm
	H162*	310 mm
	** H164*	

* Reference - SAE Recommended Practice, J162, Motor Vehicle Fiducial Marks.

*** EPA Loaded Vehicle Weight, Loading Conditions
 All Linear Dimensions Are In Millimeters (Inches)

MVMA Specifications

METRIC (U.S. Customary)

Vehicle Line Geo PRIZM
 Model Year 1990 Issued 6-89 Revised(*)

Optional Equipment Differential Mass (weight)*

Code	Equipment	MASS, kg. (lb.)			Remarks Restrictions, Requirements
		Front	Rear	Total	
AU3	Power Door Lock	1.6	0.4	2.0 (4.4)	Required w/A31
A31	Power Windows	1.8	4.8	6.6 (14.6)	Requires AU3
CA1	Sun Roof-Power	5.7	8.5	14.2 (31.3)	
C25	Rear Window Wiper	-0.2	1.7	1.5 (3.3)	GSI: Standard
C60	Air Conditioning	21	0	21 (46.3)	
K34	Cruise Control	2.8	0	2.8 (6.2)	
MS7	Automatic Transmission	18	0	18 (39.7)	
N33	Tilt Steering Wheel	1.3	0	1.3 (2.9)	
N41	Power Steering	9	0	9 (19.8)	GSI: Standard
UM6	AM/FM Stereo Radio W/Cassette	1.4	0	1.4 (3.1)	

* Also see Engine - General Section for dressed engine mass (weight).

MVMA Specifications

METRIC (U.S. Customary)

Exterior Vehicle And Body Dimensions – Key Sheet

Exterior Width

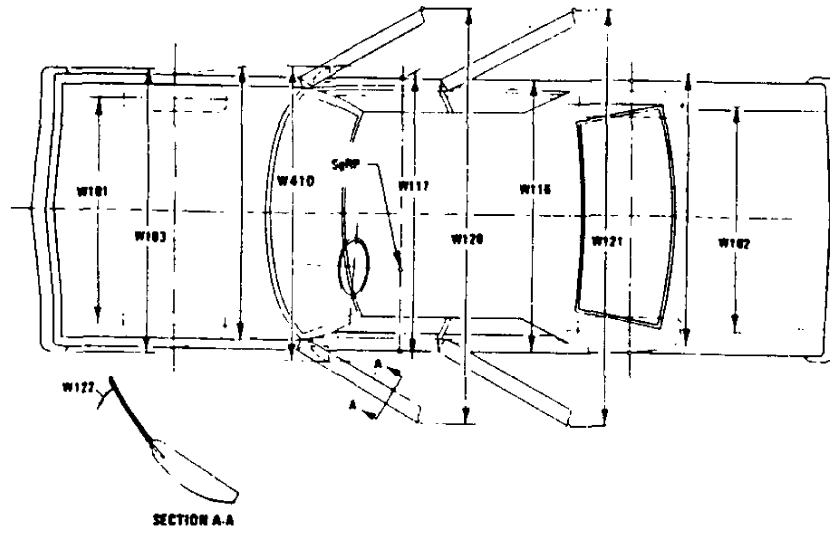

Exterior Length & Height

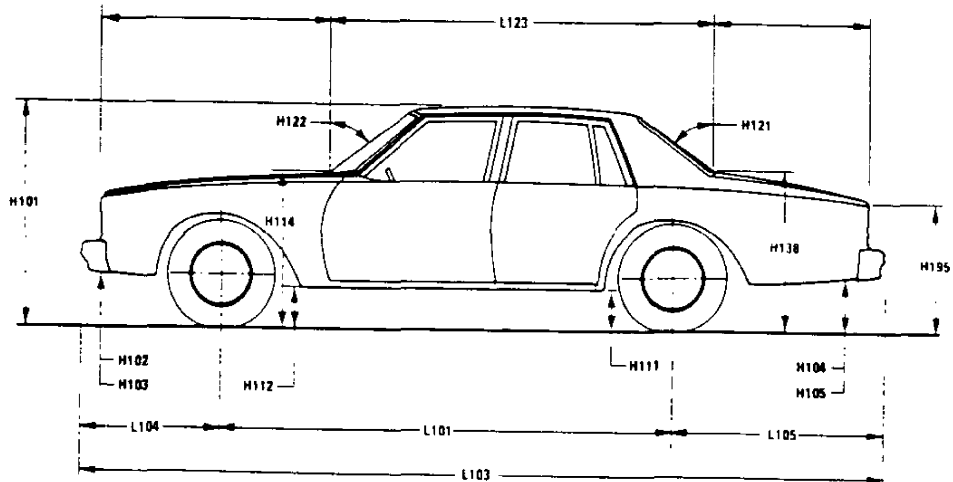

Exterior Ground Clearance

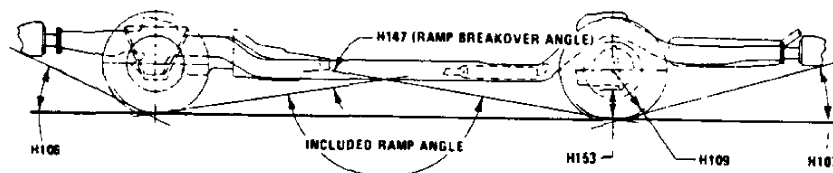

MVMA Specifications Form

METRIC (U.S. Customary)

Interior Vehicle And Body Dimensions - Key Sheet

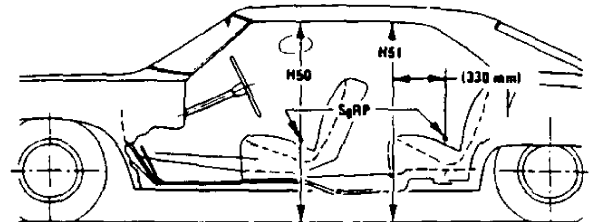
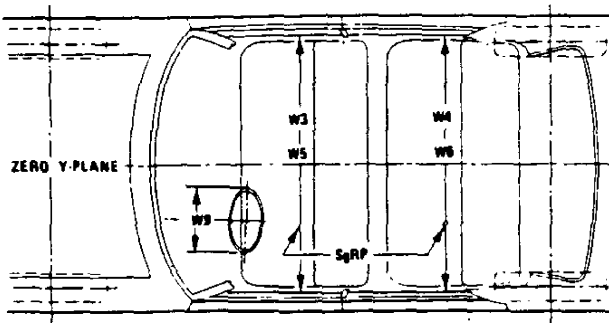
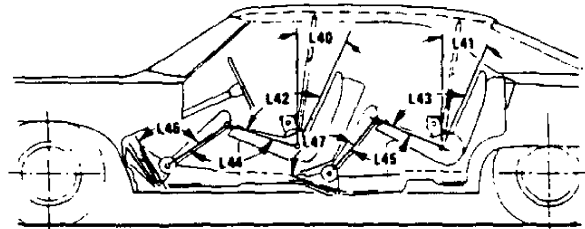
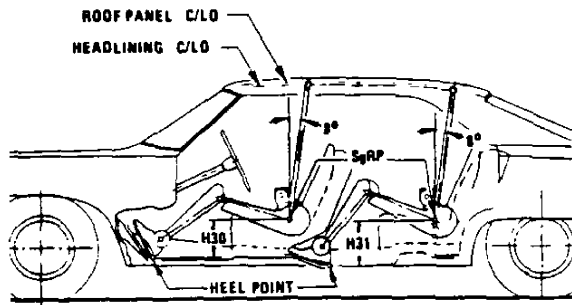
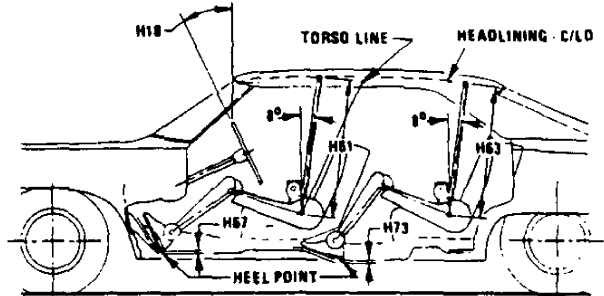
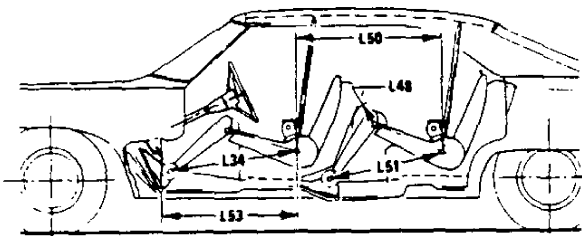

MVMA Specifications Form

METRIC (U.S. Customary)

Interior Vehicle And Body Dimensions – Key Sheet

Third Seat

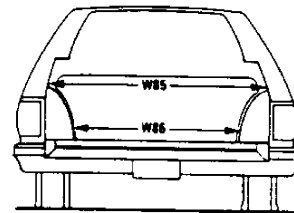
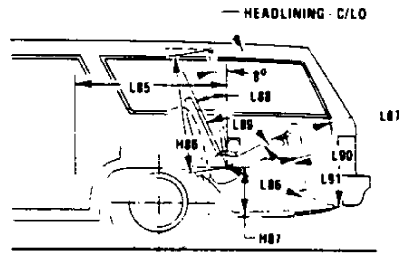

Cargo Space

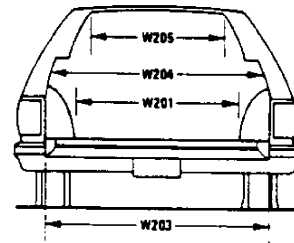
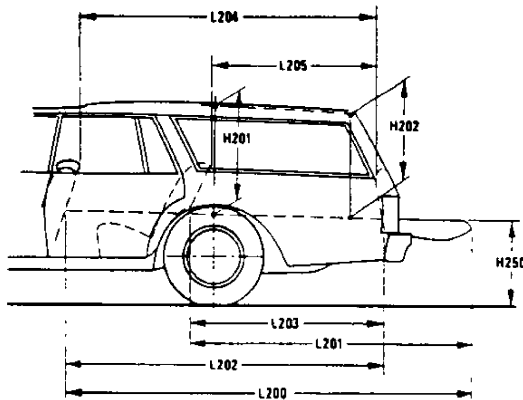

Station Wagon

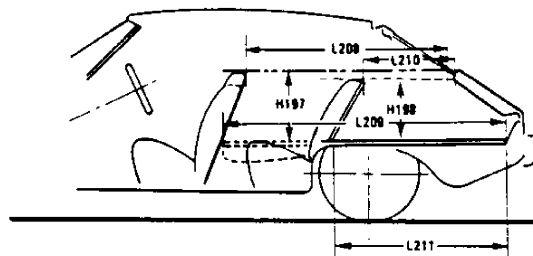

Hatchback

MVMA Specifications

METRIC (U.S. Customary)

Exterior Vehicle And Body Dimensions – Key Sheet Dimensions Definitions

Seating Reference Point

SEATING REFERENCE POINT means the manufacturer's design reference point which –

- (a) Establishes the rearmost normal design driving or riding position of each designated seating position in a vehicle;
- (b) Has coordinates established relative to the design vehicle structure;
- (c) Simulates the position of the pivot center of the human torso and thigh; and
- (d) Is the reference point employed to position the two dimensional templates described in SAE Recommended Practice J826, "Devices for Use in Defining and Measuring Vehicle Seating Accommodations."

Width Dimensions

- W101 TREAD – FRONT. The dimension measured between the tire centerlines at the ground.
- W102 TREAD – REAR. The dimension measured between the tire centerlines at the ground. In case of dual wheels, the dimension will be measured to the centerline of tire and wheel assemblies.
- W103 VEHICLE WIDTH. The maximum dimension measured between the widest point on the vehicle, excluding exterior mirrors, flexible mud flaps, marker lamps, but including bumpers, moldings, sheet metal protrusions or dual wheels, if standard equipment.
- W117 BODY WIDTH AT SgRP – FRONT. The dimension measured laterally between the widest points on the body at the SgRP-front, excluding door handles, applied moldings, or appliques.
- W120 VEHICLE WIDTH – FRONT DOORS OPEN. The dimension measured between the widest point on the front doors in maximum hold-open position.
- W121 VEHICLE WIDTH – REAR DOORS OPEN. The dimension measured between the widest point on the rear doors in maximum hold-open position. For vehicles with a rear door on only one side, this dimension is to the zero "Y" plane.
- W122 TUMBLE – HOME. STRAIGHT SIDE GLASS. The angle measured from a vertical to the outside surface of the front door glass at the SgRP "X" plane.
CURVED SIDE GLASS. The angle measured from a vertical to a chord extending from the upper DLO to the lower DLO at the outside surface of the front door glass at the front SgRP "X" plane.
- W410 OUTSIDE MIRROR WIDTH. The dimension between the widest point on the outside mirrors. The standard right and left mirror adjusted for normal driving will be shown unless otherwise noted. When only one outside mirror is standard, the dimension will be to the zero "Y" plane.

Length Dimensions

- L101 WHEELBASE (WB). The dimension measured longitudinally between front and rear wheel centerlines. In case of dual rear axles, the dimension shall be to the midpoint of the centerlines of the rear wheels.
- L103 VEHICLE LENGTH. The maximum dimension measured longitudinally between the foremost point and the rearmost point on the vehicle, including bumper, bumper guards, tow hooks and/or rub strips, if standard equipment.
- L104 OVERHAND – FRONT. The dimension measured longitudinally from the centerline of the front wheels to the foremost point on the vehicle including bumper, bumper guards, tow hooks and/or rub strips, if standard equipment.
- L105 OVERHANG – REAR. The dimension measured longitudinally from the centerline of the rear wheels; or in the case of dual rear axles, the dimension shall be the midpoint of the centerlines of the rear wheels, to the rearmost point on the vehicle including rear bumpers, bumper guards, tow hooks and rub strips, if standard equipment.

- L123 UPPER STRUCTURE LENGTH. The dimension measured longitudinally from the cowl point to the deck point.
- L127 REAR WHEEL CENTERLINE "X" COORDINATE or in the case of dual rear axles, the coordinate shall be the midpoint of the distance between the rear axle centerlines.

Height Dimensions

- H101 VEHICLE HEIGHT. The dimension measured vertically from the highest point on the vehicle body to ground.
- H111 ROCKER PANEL – REAR TO GROUND. The dimension measured vertically from the bottom of the rocker or side quarter panel at the front of the rear wheel opening, excluding flanges, to ground.
- H112 ROCKER PANEL – FRONT TO GROUND. The dimension measured vertically from the foremost point on the bottom of the rocker panels, excluding flanges, to ground.
- H114 COWL POINT TO GROUND. Measured at zero "Y" plane.
- H121 BACKLIGHT SLOPE ANGLE. The angle between the vertical reference line and the surface of the backlight at vehicle zero "Y" plane. For curve backlight, the angle is to chord of backlight arc from lower DLO to upper DLO.
- H122 WINDSHIELD SLOPE ANGLE. The angle between the vertical reference line and a chord of the windshield arc running from the lower DLO to the upper DLO at the vehicle zero "Y" plane. In the case of wrap over glass, the angle to be measured will be formed by a chord 457 mm (18.0 in.) long drawn from the lower DLO to the intersecting point on the windshield.
- H138 DECK POINT TO GROUND. Measured at zero "Y" plane.
- H109 STATIC LOAD – TIRE RADIUS – REAR. Specified by the manufacturer in accordance with composite TIRE SECTION STANDARD.

Ground Clearance Dimensions

- H102 FRONT BUMPER TO GROUND. The minimum dimension measured vertically from the lowest point on the front bumper to ground, including bumper guards, if standard equipment.
- H103 FRONT BUMPER TO GROUND – CURB MASS (WT.). Measured in the same manner as H102.
- H104 REAR BUMPER TO GROUND. The minimum dimension measured vertically from the lowest point on the rear bumper to ground, including bumper guards, if standard equipment.
- H105 REAR BUMPER TO GROUND – CURB MASS (WT.). Measured in the same manner as H104.
- H106 ANGLE OF APPROACH. The angle measured between a line tangent to the front tire static loaded radius arc and the initial point of structural interference forward of the front tire to ground. The limiting structural component shall be designated.
- H107 ANGLE OF DEPARTURE. The angle measured between a line tangent to the rear tire static loaded radius arc and the initial point structural interference rearward of the rear tire to ground. The limiting component shall be designated.
- H147 RAMP BREAKOVER ANGLE. The angle measured between two lines tangent to the front and rear tire static loaded radius and intersecting at a point on the underside of the vehicle which defines the largest ramp over which the vehicle can roll.
- H153 REAR AXLE DIFFERENTIAL TO GROUND. The minimum dimension measured from the rear axle differential to ground.
- H156 MINIMUM RUNNING GROUND CLEARANCE. The minimum dimension measured from the sprung vehicle to ground. Specify location.

MVMA Specifications

METRIC (U.S. Customary)

Interior Vehicle And Body Dimensions – Key Sheet Dimensions Definitions

Glass Areas

- S1 Windshield area.
- S2 Side windows area. Includes the front door, rear door, vents, and rear quarter windows on both sides of the vehicle.
- S3 Backlight areas.
- S4 Total area. Total of all areas (S1 + S2 + S3).

Fiducial Mark Dimensions

Fiducial Mark – Number 1

- L54 "X" coordinate.
- W21 "Y" coordinate.
- H81 "Z" coordinate.
- H161 Height "Z" coordinate to ground at curb weight.
- H163 Height "Z" coordinate to ground.

Fiducial Mark – Number 2

- L55 "X" coordinate.
- W22 "Y" coordinate.
- W82 "Z" coordinate.
- H162 Height "Z" coordinate to ground at curb weight.
- H164 Height "Z" coordinate to ground.

Front Compartment Dimensions

- L11 ACCELERATOR HEEL POINT TO STEERING WHEEL CENTER. The dimension measured horizontally from the AHP to the intersection of the steering column centerline and a plane tangent to the upper surface of the steering wheel rim.
- L17 DESIGN H-POINT – FRONT TRAVEL. The dimension measured horizontally between the design H-point – front in the foremost and rearmost seat track positions. (See SAE J1100)
- L23 NORMAL DRIVING AND RIDING SEAT TRACK TRAVEL. The dimension measured horizontally between a point on the design H-point travel line from the SgRP to the displaced point on the design H-point travel line with the seat moved to the foremost seat position, but not to include seat track travel used for purposes other than normal driving and riding positions. (See SAE J1100).
- L31 SgRP – FRONT. "X" COORDINATED.
- L34 MAXIMUM EFFECTIVE LEG ROOM – ACCELERATOR. The dimension measured along a line from the ankle pivot center to the SgRP – front plus 254 mm (10.0 in.) measured with right foot on the undepressed accelerator pedal. For vehicles with SgRP to heel (H30) greater than 18 in., the accelerator pedal may be depressed as specified by the manufacturer. If the accelerator is depressed, the manufacturer shall place foot flat on pedal and note the depression of the pedal.
- L-40 BACK ANGLE – FRONT. The angle measured between a vertical line through the SgRP – front and the torso line. If the seatback is adjustable, use the normal driving and riding position specified by the manufacturer.
- L-42 HIP ANGLE – FRONT. The angle measured between torso line and thigh centerline.
- L44 KNEE ANGLE – FRONT. The angle measured between thigh centerline and lower leg centerline measured on the right leg.
- L46 FOOT ANGLE – FRONT. The angle measured between the lower leg centerline and a line tangent to the ball and heel of the bare foot flesh line measured on the right leg. Ref SAE J826.
- L53 SgRP – FRONT TO HEEL. The dimension measured horizontally from the SgRP – front to the accelerator heel point.
- W3 SHOULDER ROOM – FRONT. The minimum dimension measured laterally between the trimmed surfaces on the "X" plane through the SgRP – front at height between the belt line and 254 mm (10.0 in.) above the SgRP – front, excluding the door assist strap and attaching parts.

- W5 HIP ROOM – FRONT. The minimum dimension measured laterally between the trimmed surfaces on the "X" plane through the SgRP – front within 25 mm (1.0 in.) below and 76 mm (3.0 in.) above the SgRP – front and 76 mm (3.0 in.) fore and aft of the SgRP – front.
- W9 STEERING WHEEL MAXIMUM OUTSIDE DIAMETER. Define if other than round.
- H7 ACCELERATOR HEEL POINT TO THE STEERING WHEEL CENTER. The dimension measured vertically from the AHP – front to the intersection of the steering column centerline to a plane tangent to the upper surface of the steering wheel rim.
- H18 STEERING WHEEL ANGLE. The angle measured from a vertical to the surface plane of the steering wheel.
- H30 SgRP – FRONT TO HEEL. The dimension measured vertically from the SgRP – front to the accelerator heel point.
- H50 UPPER BODY OPENING TO GROUND – FRONT. The dimension measured vertically from the trimmed body opening to the ground on the SgRP – front "X" plane.
- H61 EFFECTIVE HEAD ROOM – FRONT. The dimension measured along a line 8 deg. rear of vertical from the SgRP – front to the headlining plus 102 mm (4.0 in.).
- H67 FLOOR COVERING THICKNESS – UNDEPRESSED – FRONT. The dimension measured vertically from the surface of the undepressed floor covering to the underbody sheet metal at the accelerator heel point.

Rear Compartment Dimensions

- L-41 BACK ANGLE – SECOND. The angle measured between a vertical line through the SgRP – second and the torso line.
- L43 HIP ANGLE – SECOND. The angle measured between torso line and thigh centerline.
- L45 KNEE ANGLE – SECOND. The angle measured between thigh centerline and lower leg centerline.
- L47 FOOT ANGLE – SECOND. The angle measured between the lower leg centerline and a line tangent to the ball and heel of the three-dimensional devices bare foot flesh line (Reference J826).
- L48 KNEE CLEARANCE – SECOND. The minimum dimension measured from the knee pivot center to the back of the front seatback minus 51 mm (2.0 in.).
- L50 SgRP COUPLE DISTANCE – SECOND. The dimension measured horizontally from the driver SgRP – front to the SgRP – second.
- L51 MINIMUM EFFECTIVE LEG ROOM – SECOND. The dimension measured along a line from the ankle pivot center to the SgRP – second plus 254 mm (10.0 in.).
- W4 SHOULDER ROOM – SECOND. The minimum dimension measured laterally between door or quarter trimmed surfaces on the "X" plane through the SgRP – second at height between 254-406 mm (10.0-16.0 in.) above the SgRP – second, excluding the door assist straps and attaching parts.
- W6 HIP ROOM – SECOND. Measured in the same manner as W5.
- H31 SgRP – SECOND TO HEEL. The dimension measured vertically from the SgRP – second to the two dimensional device heel point on the depressed floor covering.
- H51 UPPER BODY OPENING TO GROUND – SECOND. The dimension measured vertically from the trimmed body opening to the ground on the "X" plane 330 mm (13.0 in.) forward of the SgRP – second.
- H63 EFFECTIVE HEAD ROOM – SECOND. The dimension measured along a line 8 deg. rear of vertical from the SgRP to the headlining, plus 102 mm (4.0 in.).
- H73 FLOOR COVERING – DEPRESSED – SECOND. The dimension measured vertically from the heel point to the underbody sheet metal.

MVMA Specifications

METRIC (U.S. Customary)

Interior Vehicle And Body Dimensions – Key Sheet Dimensions Definitions

Luggage Compartment Dimensions

V1 USABLE LUGGAGE CAPACITY—Total of volumes of individual pieces of standard luggage set plus H-boxes stowed in the luggage compartment in accordance with the procedure described in paragraph 8.2 of SAE-J1100a.

Interior Volumes (EPA Classification)

The Interior Volume Index is listed for each body style except two seaters. The Interior Volume Index estimates the space in a car. It is based on four measurements — head room, shoulder room, hip room, and leg room — for the front and rear seats, plus trunk capacity. The Interior Volume Index is an estimate of the size of the passenger compartment.

The Trunk/Cargo Index is an estimate of the size of the trunk cargo space. In station wagons and hatchbacks it is an estimate of the space behind the second seat.

Station Wagon – Third Seat Dimensions

- L85 SgRP COUPLE DISTANCE – THIRD. The dimension measured horizontally from the SgRP – second to the SgRP – third.
- L86 EFFECTIVE LEG ROOM – THIRD. The dimension measured along a line from the ankle pivot center to the SgRP – third plus 254 mm (10.0 in.).
- L87 KNEE CLEARANCE – THIRD. The minimum dimension from the knee pivot center to the back of second seatback minus a constant of 51 mm (2.0 in.). With rear-facing third seat, dimension is measured to closure.
- L88 BACK ANGLE – THIRD. Measured in the same manner as L41.
- L89 HIP ANGLE – THIRD. Measured in the same manner as L43.
- L90 KNEE ANGLE – THIRD. Measured in the same manner as L45.
- L91 FOOT ANGLE – THIRD. Measured in the same manner as L47.
- W85 SHOULDER ROOM – THIRD. Measured in the same manner as W4.
- W86 HIP ROOM – THIRD. Measured in the same manner as W5.
- H86 EFFECTIVE HEAD ROOM – THIRD. The dimension, measured along a line 8 deg. from the SgRP – third to the headlining rear of vertical plus a constant of 102 mm (4.0 in.).
- H87 SgRP – THIRD TO HEEL POINT.
- SD1 SEAT FACING DIRECTION – THIRD.

Station Wagon – Cargo Space Dimensions

- L200 CARGO LENGTH – OPEN – FRONT. The minimum dimension measured longitudinally from the back of the front seatback at the height of the undepressed floor covering to the rearmost point on the undepressed floor covering on the open tailgate or cargo surface if the rear closure is a conventional door type tailgate at the zero "Y" plane.
- L201 CARGO LENGTH – OPEN – SECOND. The dimension measured longitudinally from the back of the second seatback at the height of the undepressed floor covering to the rearmost point on the undepressed floor covering on the open tailgate or cargo floor surface if the rear closure is a conventional door type tailgate, at the zero "Y" plane.

- L202 CARGO LENGTH – CLOSED – FRONT. The minimum dimension measured horizontally from the back of the front seat at the height of the undepressed floor covering to the rearmost point on the undepressed floor covering on the closed tailgate or taildoor for station wagons, trucks and mpv's at the zero "Y" plane.
- L203 CARGO LENGTH – CLOSED – SECOND. The dimension measured horizontally from the back of the second seat at the height of the undepressed floor covering to the rearmost point on the undepressed floor covering on the closed tailgate or taildoor for station wagons, trucks and mpv's at the zero "Y" plane.
- L204 CARGO LENGTH AT BELT – FRONT. The minimum dimension measured horizontally from the back of the front seatback at the seatback top to the foremost normal surface of the closed tailgate or inside surface of the cab backpanel at the height of the belt, on the zero "Y" plane.
- L205 CARGO LENGTH AT BELT – SECOND. The minimum dimension measured horizontally from the back of the second seatback at the seatback top to the foremost normal surface of the closed tailgate at the height of the belt, on the zero "Y" plane.
- W201 CARGO WIDTH – WHEELHOUSE. The minimum dimension measured laterally between the trimmed wheelhousings at floor level. For any vehicle not trimmed, measure to the sheet metal.
- W203 REAR OPENING WIDTH AT FLOOR. The minimum dimension measured laterally between the limiting interferences of the rear opening at floor level.
- W204 REAR OPENING WIDTH AT BELT. The minimum dimension measured laterally between the limiting interferences of the rear opening at belt height or top of pick up box.
- W205 REAR OPENING WIDTH ABOVE BELT. The minimum dimension measured laterally between the limiting interferences of the rear opening above the belt height.
- H197 FRONT SEATBACK TO LOAD FLOOR HEIGHT. The dimension measured vertically from the horizontal tangent to the top of the seatback to the undepressed floor covering.
- H201 CARGO HEIGHT. The dimension measured vertically from the top of the undepressed floor covering to the headlining at the rear wheel "X" coordinate on the zero "Y" plane.
- H202 REAR OPENING HEIGHT. The dimension measured vertically from the top of the undepressed floor covering to the upper trimmed opening on the zero "Y" plane with rear door fully open.
- H250 TAILGATE TO GROUND CURB MASS (WT.). The dimension measured vertically from the top of the undepressed floor covering on the lowered tailgate to ground on the zero "Y" plane.
- V2 STATION WAGON

Measured in inches:

$$\frac{W4 \times H201 \times L204}{1728} = \text{ft}^3$$

Measured in mm:

$$\frac{W4 \times H201 \times L204}{10^9} = \text{m}^3 \text{ (cubic meter)}$$

MVMA Specifications

METRIC (U.S. Customary)

Interior Vehicle And Body Dimensions – Key Sheet Dimensions Definitions

V4 HIDDEN LUGGAGE CAPACITY – REAR OF FRONT SEAT.
The total volumes of individual pieces of one set of standard luggage stowed in any hidden cargo area below the load floor rear of the front seat.

V5 TRUCKS AND MPV'S WITH OPEN AREA.
Measured in inches:

$$\frac{L506 \times W505 \times H503}{1728} = \text{ft}^3$$

Measured in mm:

$$\frac{L506 \times W500 \times H503}{10^9} = \text{m}^3 \text{ (cubic meter)}$$

V6 TRUCKS AND MPV'S WITH CLOSED AREA.

Measured in inches:

$$\frac{L204 \times W500 \times H505}{1728} = \text{ft}^3$$

Measured in mm:

$$\frac{L204 \times W500 \times H505}{10^9} = \text{m}^3 \text{ (cubic meter)}$$

V8 HIDDEN LUGGAGE CAPACITY – REAR OF SECOND SEAT. The total volume of individual pieces of one set of standard luggage stowed in any hidden cargo area below the load floor rear of the second seat.

V10 STATION WAGON CARGO VOLUME INDEX.
Measured in inches:

$$\frac{H201 \times L205 \times \frac{W4 + W201}{2}}{1728} = \text{ft}^3$$

Measured in mm:

$$\frac{H201 \times L205 \times \frac{W4 + W201}{2}}{10^9} = \text{m}^3 \text{ (cubic meter)}$$

Hatchback – Cargo Space Dimensions

All hatchback cargo dimensions are to be taken with the front seat in full down and rear position, and the rear seat folded down. The hatchback door is in the closed position. (For electronically adjusted seats, see the manufacturer's specifications for Design "H" Point).

L208 CARGO LENGTH AT FRONT SEATBACK HEIGHT. The minimum horizontal dimension from the "X" plane tangent to the rearmost surface of the driver's seatback to the inside limiting interference of the hatchback door on the vehicle zero "Y" plane.

L209 CARGO LENGTH AT FLOOR – FRONT – HATCHBACK. The minimum horizontal dimension measured at floor level from the rear of the front seatback to the normal limiting interference of the hatchback door on the vehicle zero "Y" plane.

L210 CARGO LENGTH AT SECOND SEATBACK HEIGHT – HATCHBACK. The minimum dimension measured from the "X" plane tangent to the rearmost surface second seatback or the load floor which is stowed at less than one half of the H198 dimension height above the rear load floor, to the rearmost inside limiting interference on the zero "X" plane.

L211 CARGO LENGTH AT FLOOR – SECOND HATCHBACK. The minimum horizontal dimension measured at floor level from the rear of the second seatback or load floor panel to the normal limiting interference of the hatchback door on the vehicle zero "Y" plane.

H197 FRONT SEATBACK TO LOAD HEIGHT. The dimension measured vertically from the horizontal tangent to the top of the seatback to the undepressed floor covering.

H198 SECOND SEATBACK TO LOAD FLOOR HEIGHT: This dimension measured vertically from the second seatback to the undepressed floor covering.

V3 HATCHBACK.

Measured in inches:

$$\frac{\frac{L208 + L209}{2} \times W4 \times H197}{1728} = \text{ft}^3$$

Measured in mm:

$$\frac{\frac{L208 + L209}{2} \times W4 \times H197}{10^9} = \text{m}^3 \text{ (cubic meter)}$$

V4 HIDDEN LUGGAGE CAPACITY – REAR OF FRONT SEAT. The total volumes of individual pieces of one set of standard luggage stowed in any hidden cargo area below the load floor rear of the front seat.

V11 HATCHBACK CARGO VOLUME INDEX. Usable luggage (one (1) stand and luggage set) below floor:
Measured in inches:

$$\frac{\frac{L210 + L211}{2} \times W4 \times H198}{1728} = \text{ft}^3$$

Measured in mm:

$$\frac{\frac{L210 + L211}{2} \times W4 \times H198}{10^9} = \text{m}^3 \text{ (cubic meter)}$$

VMA Specifications

METRIC (U.S. Customary)

Index

Subject	Page No.
Alternator	16
Drive, Front, Rear, All Four	2, 9, 10
Shafts	10
Battery	16
Body and Miscellaneous Information	17
Brakes - Parking Service	12, 13
Bumper	15
Cams/camshaft	3
Capacities	
Cooling System	5
Fuel Tank	6
Lubricants	
Engine Crankcase	4
Transmission / Transaxle	8, 9
Rear Axle	10
Carburetor	2, 6
Caster	15
Clutch - Pedal Operated	8
Coil, Ignition	16
Connecting Rods	4
Convenience Equipment	19-20
Cooling System	5
Crankshaft	4
Cylinders and Cylinder Head	3
Diesel Information	4
Dimension Definitions	
Key Sheet - Exterior	27, 30, 31
Key Sheet - Interior	28, 29, 31, 32, 33
Electrical System	15, 16
Emission Controls	7
Engine - General	
Bore, Stroke, Type	3
Compression Ratio	2
Displacement	2, 3
Firing Order, Cylinder Numbering	3
General Information, Power & Torque	2
Intake System	4
Power Teams	2
Exhaust System	7
Equipment Availability, Convenience	19
Fan, Cooling	5
Filters - Engine Oil, Fuel System	4
Four Wheel Drive	10
Frame	18
Front Suspension	11
Front Wheel Drive Unit	10
Fuel System	6
Fuel Injection	6
Fuel Tank	6
Glass	18
Headlamps	18
Headroom - Body	22, 23
Heights	21
Horns	15
Horsepower - Brake	2
Ignition System	16
Inflation - Tires	13
Interior Volumes	22
Instruments	15
Legroom	22, 23
Lengths	21
Leveling, Suspension	11
Lifters, Valve	4
Linings - Clutch, Brake	8, 12
Lubrication - Engine Transmission / Transaxle	4, 8, 9
Luggage Compartment	22
Models	1
Motor Starting	16
Muffler	7
Origin	1

Subject	Page No.
Passenger Capacity	1
Passenger Mass Distribution	25
Pistons	3
Power Brakes	12
Power, Engine	2
Power Steering	14
Power Teams	2
Propeller Shaft	10
Pumps - Fuel	6
Water	5
Radiator - Cap, Hoses, Core	5
Ratios - Axle, Transaxle	2, 8, 9
Compression	2
Steering	14
Transmission / Transaxle	2, 8, 9
Rear Axle	2, 10
Regulator - Alternator	16
Restraint System	18
Rims	13
Rods - Connecting	4
Scrub Radius	14
Seats	17
Shock Absorbers, Front & Rear	11
Spark Plugs	16
Speedometer	15
Springs - Front & Rear Suspension	11
Stabilizer (Sway Bar) - Front & Rear	11
Starting System	16
Steering	14
Suppression - Ignition, Radio	16
Suspension - Front & Rear	11
Tail Pipe	7
Theft Protection	20
Thermostat, Cooling	5
Tires	13
Toe-In	15
Torque Converter	9
Torque - Engine	2, 8, 9
Transaxle	9
Transmission - Types	2, 8, 9
Transmission - Automatic	2, 9
Transmission - Manual	2, 8
Transmission - Ratios	2, 8, 9
Tread	21
Trunk Cargo Load	1
Trunk Luggage Capacity	22
Turning Diameter	14
Unitized Construction	18
Universal Joints, Propeller Shaft	10
Valve System	4
Vehicle Dimensions	
Width	21
Length	21
Height	21
Ground Clearance	21
Front Compartment	22
Rear Compartment	22
Luggage Compartment	22
Station Wagon - Third Seat	23
Station Wagon - Cargo Space	23
Hatchback - Cargo Space	23
Fiducial Marks	24
Voltage Regulator	16
Water Pump	5
Weights	25, 26
Wheel Alignment	15
Wheelbase	21
Wheels & Tires	13
Wheel Spindle	14
Widths	2
Windshield	16
Windshield Wiper and Washer	15