

1  
2  
3  
4  
5  
6  
7  
8  
9  
10

11  
12  
13  
14  
15  
16  
17  
18  
19  
20

# MANUFACTURERS MOTOR VEHICLE SPECIFICATIONS

METRIC (U.S. Customary)

# 1992

<b>Manufacturer</b> SUZUKI MOTOR CORPORATION	<b>Vehicle Line</b>  Geo TRACKER	
<b>Mailing Address</b> CHEVROLET-PONTIAC-CANADA GROUP ENGINEERING CENTER GENERAL MOTORS CORPORATION 30003 VAN DYKE WARREN, MICHIGAN 48090-9060	<b>Issued</b> SEPTEMBER, 1991	<b>Revised</b>

Direct questions concerning these specifications to the manufacturer listed above.

The information contained herein is prepared, distributed by, and is solely the responsibility of the vehicle manufacturing company to whose products it relates. This specification form was developed by the vehicle manufacturing companies under the auspices of the Motor Vehicle Manufacturers Association of the United States, Inc.

The General Specifications herein are those in effect at date of compilation and are subject to change without notice or incurring obligation by the manufacturer.



Motor Vehicle Manufacturers Association  
of the United States, Inc.

Blank Forms Provided by Technical Affairs Division



1  
2



1

1



# MVMA Specifications

METRIC (U.S. Customary)

## Table of Contents

---

	1	Vehicle Models/Origin	○ Indicates Format Change From Previous Year
	2	Power Teams	
○	3	Engine	
	4	Lubrication System	
	4	Diesel Information	
	5	Cooling System	
	6	Fuel System	
	7	Vehicle Emission Control	
	7	Exhaust System	
○	8-10	Transmission, Axles and Shafts	
○	11	Suspension	
○	12-13	Brakes, Tires and Wheels	
○	14	Steering	
	15-16	Electrical	
	17	Body — Miscellaneous Information	
○	17	Frame	
	18	Restraint System	
	18	Glass	
	18	Headlamps	
○	19	Climate Control System	
	20-21	Convenience Equipment	
	21	Trailer Towing	
○	22-24	Vehicle Dimensions	
	25	Vehicle Fiducial Marks	
	26	Vehicle Mass (Weight)	
	27	Optional Equipment Differential Mass (Weight)	
○	28-34	Vehicle Dimensions Definitions - Key Sheets	
○	35	Index	

---

### NOTE:

1. This form uses both SI metric units and U.S. Customary units. The metric unit of measure is presented first, and the U.S. Customary unit follows in parentheses.
2. UNLESS OTHERWISE INDICATED:
  - a. Specifications apply to standard models without optional equipment. Significant deviations are noted.
  - b. Nominal design dimensions are used throughout these specifications.
  - c. All linear dimensions are in millimeters (inches), and all mass (weight) specs. are in kilograms (pounds).
3. The General Specifications herein are those in effect at date of compilation and are subject to change without notice or incurring obligation by the manufacturer.
4. Additional Vehicle Dimensions (based in part on SAE J1100 "Motor Vehicle Dimensions") may be available from the manufacturer.

FORM MVMA-92



# MVMA Specifications

Vehicle Line Geo TRACKER  
Model Year 1992 Issued 9-91 Revised(\*) \_\_\_\_\_

METRIC (U.S. Customary)

## Vehicle Origin

Design & development (company)	Suzuki Motor Corporation
Where built (country)	Canada
Authorized U.S. Sales marketing representative	Chevrolet/Geo

## Vehicle Models

Model Description & Drive (FWD/RWD/AWD/4WD)*	Make, Vehicle Models, Series, Body Type (Mfr's Model Code)	No. of Designated Seating Positions (Front/Rear)	Max. Trunk/Cargo Load-Kilograms (Pounds)	EPA Fuel Economy (City/Hwy)
Geo TRACKER Convertible (4WD)	J10367	2/2	100 (220)	25/27, Man. 23/24, Auto.
Geo TRACKER Hardtop (4WD)	J10316	2/2	90 (200)	25/27, Man. 23/24, Auto.
Geo TRACKER Convertible (2WD)	E10367	2/2	180 (400)	25/27, Man. 23/24, Auto.

\* FWD - Front Wheel Drive RWD - Rear Wheel Drive AWD - All Wheel Drive 4WD - Four Wheel Drive



# MVMA Specifications

Vehicle Line Geo TRACKER  
 Model Year 1992 Issued 9-91 Revised(\*)           

## METRIC (U.S. Customary)

Engine Description  
 Engine Code

1.6 LITER L4 (97 CID)  
 ELECTRONIC FUEL INJECTION RPO LS5

### ENGINE - GENERAL

Type & description (inline, V, angle, flat, location, front, mid, rear, transverse, longitudinal, sohc, dohc, ohv, hemi, wedge, pre-chamber, etc.)		Inline, Front, Longitudinal, SOHC
Manufacturer		SUZUKI MOTOR CORPORATION
No. of cylinders		4
Bore		75 mm (2.95 in.)
Stroke		90 mm (3.54 in.)
Bore spacing (C/L to C/L)		84 mm (3.30 in.)
Cyl block matl & mass kg(lbs.) (machined)		Aluminum Alloy, 17.5 (38.6)
Cylinder block deck height		263.8 mm (10.39 in.)
Cylinder block length		372 mm (14.65 in.)
Deck clearance (minimum) (above or below block)		0.9 mm (0.04 in.)
Cyl. head material & mass kg (lbs.)		Aluminum Alloy, 6.9 (15.2)
Cylinder head volume cu. cm. (cu. in.)		32.2 (1.96)
Cylinder liner material		Cast Iron
Head gasket thickness (compressed)		1.2 mm (0.05 in.)
Minimum combustion chamber total volume cm. cu. (cu. in.)		44.6 (2.72)
Cyl. no. system (front to rear)	L. Bank	1-2-3-4
	R. Bank	---
Firing order		1-3-4-2
Intake manifold matl & mass kg(lbs.) **		Aluminum Alloy, 2.6 (5.7)
Exh. manifold matl & mass kg (lbs.) **		Cast Iron, 3.9 (8.6)
Knock sensor (number & location)		Not Applicable
Fuel required unleaded, diesel, etc.		Unleaded
Fuel antiknock index (R + M) / 2		87
Engine mounts	Quantity	3
	Matl and type (elastomeric, hydroelastic, hydraulic damper, etc.)	Rubber (Elastomeric)
	Added isolation (sub-frame, crossmember, etc.)	Crossmember (For Engine Rear Mount)
Total dressed engine mass (wt) dry***		89 kg (196 lbs.)

### Engine - Pistons

Material & mass, g (weight, oz.) - piston only	Aluminum Alloy, 226 (7.9)
--	---------------------------

### Engine Camshaft

Location		In Cylinder Head
Material & mass kg (weight, lbs.)		Cast Iron, 2.1 (4.7)
Drive type	Chain/belt	Belt
	Width/pitch	19.1/9.5 mm (0.75/0.38 in.)

\*Rear of engine - drive takeoff. View from drive takeoff end to determine left & right side of engine.  
 \*\*Finished state.  
 \*\*\*Dressed engine mass (weight) includes the following:



# MVMA Specifications

Vehicle Line Geo TRACKER  
 Model Year 1992 Issued 9-91 Revised(\*)

## METRIC (U.S. Customary)

### Engine Description

Engine Code

1.6 LITER L4 (97 CID)  
 ELECTRONIC FUEL INJECTION RPO LSS

### Engine - Valve System

Hydraulic lifters (std., opt., n.a.)		Not Applicable
Valves	Number intake/exhaust	4/4
	Head O.D. intake/exhaust	36.6/32.5 mm (1.44/1.28 in.)

### Engine - Connecting Rods

Material & mass kg., (weight, lbs.)*	Forged Steel, 0.396 (0.873)
Length(axes centerline to centerline)	139.6

### Engine - Crankshaft

Material & mass kg., (weight, lbs.)*	Nodular Cast Iron, 12.1 (26.7)	
End thrust taken by bearing (no.)	2	
Length & number of main bearings	18 mm (0.71 in.) x 5	
Seal (material, one, two piece design, etc.)	Front	1
	Rear	1

### Engine - Lubrication System

Normal oil pressure kPa(psi) @ eng rpm	40 (0.58) @ 4,000
Type oil intake (floating, stationary)	Stationary
Oil filter sys. (full flow, part, other)	Full Flow
Capacity of c/case, less filter-refill-L (qt.)	4.0 (4.2)

### Engine - Diesel Information

(NOT APPLICABLE)

Diesel engine manufacturer	
Glow plug, current drain at 0 deg. F	
Injector Nozzle	Type
	Opening pressure kPa(psi)
Pre-chamber design	
Fuel injection pump	Manufacturer
	Type
Fuel inj. pump drive (belt, chain, gear)	
Supplementary vacuum source (type)	
Fuel heater (yes/no)	
Water separator, description (std., opt.)	
Turbo manufacturer	
Oil cooler-type (oil to engine coolant; oil to ambient air)	
Oil filter	

### Engine - Intake System

(NOT APPLICABLE)

Turbo charger - manufacturer	
Super charger - manufacturer	
Intercooler	

\* Finished State

# MVMA Specifications

Vehicle Line Geo TRACKER  
 Model Year 1992 Issued 9-91 Revised(\*)           

## METRIC (U.S. Customary)

Engine Description  
 Engine Code

1.6 LITER L4 (97 CID)  
 ELECTRONIC FUEL INJECTION RPO LS5

### Engine - Cooling System

Coolant recovery system (std, opt, n.a.)		Standard
Coolant fill location (rad., bottle)		Bottle
Radiator cap relief valve pressure kPa (psi)		88.2 (12.8)
Circulation thermostat	Type (choke, bypass)	Choke
	Starts to open @ deg's C(F)	82 (180)
Water Pump	Type (centrifugal, other)	Centrifugal
	GPM 1000 pump rpm	3.5
	Number of pumps	1
	Drive (V-belt, other)	V-Ribbed Belt
	Bearing type	Roller & Ball
	Impeller material	Steel
Housing material		Aluminum Alloy
By-pass recirculation type (inter., ext.)		Ext.
Cooling system capacity	With heater - L (qt.)	MT: 5.6 (5.92), AT: 5.5 (5.81)
	With air conditioner-L(qt.)	Not Applicable
	Opt. equip. specify-L(qt.)	"
Water jackets full length of cyl(yes,no)		Yes
Water all around cylinder (yes, no)		Yes
Water jackets open at head face (yes,no)		Yes
Radiator core	Std., A/C, HD	Standard
	Type (cross-flow, etc.)	Vertical Flow
	Construction (fin & tube mechanical, braze, etc.)	Fin & Tube
	Matl. mass kg (wgt.,lbs.)	Aluminum, 3.0 (6.6)
	Width	MT: 482 mm (18.98 in.), AT: 504 mm (19.84 in.)
	Height	375 mm (14.76 in.)
	Thickness	34 mm (1.34 in.)
Fins per inch		MT: 3.5 mm/2. AT: 3.5 mm/2
Radiator end tank material		Plastic
Fan	Std., elec., opt.	Standard
	Number of blades & type (flex, solid, material)	5, Flex, Plastic
	Diameter & projected width	340 mm (13.39 in.) & 65 mm (2.56 in.)
	Ratio(fan to crnksht.rev.)	117:130
	Fan cutout type	Bimetal & Fluid Coupling
	Drive type (direct, remote)	Clutch Fan. Remote
	RPM at idle (elec.)	800
	Motor rating(wattage)(elec)	Not Applicable
	Motor switch (type & location/elec.)	"
	Switch point (temp./ pressure/elec.)	"
Fan shroud (material)		Plastic

# MVMA Specifications

Vehicle Line Geo TRACKER  
 Model Year 1992 Issued 8-91 Revised(\*)

## METRIC (U.S. Customary)

### Engine Description

1.6 LITER L4 (97 CID)

### Engine Code

ELECTRONIC FUEL INJECTION RPO LS6

### Engine - Fuel System (See supplemental page for details of Fuel Inj. Supercharger, Turbocharger, etc. if used)

Induction type: carburetor, fuel injection system, etc.		Fuel Injection
Manufacturer		Mitsubishi - Mikuni
Carburetor no. of barrels		Not Applicable
Idle A/F mix.		14.6
Fuel injection	Point of inj. (no.)	Throttle Body (1)
	Constant, pulse, flow	Pulse Flow
	Control (elec., mech.)	Electronic
	Sys. press. kPa (psi)	250 (36)
Idle spd. -rpm (spec. neutral or drive and propane if used)	Manual	800 (Neutral)
	Automatic	800 (Neutral Or Park)
Intake manifold heat control (exhaust or water thermostatic or fixed)		Water Thermostatic
Air cleaner type		Replaceable Paper Element, Single Snorkel
Fuel filter (type/location)		Paper Element, Under Floor - Rear
Fuel pump	Type (elec. or mech.)	Electrical
	Location (eng., tank)	Fuel tank
	Press. range kPa (psi)	250 (36)
	Flow rate at regulated pressure L (gal)/hr @ kPa (psi)	80 (21.1) @ 250 (36)

### Fuel Tank

Capacity refill L (gallons)		42 (11.1)
Location (describe)		Under Floor - Rear
Attachment		Bolts
Material & Mass kg (weight lbs.)		Steel, 8.4 (18.5)
Filler pipe	Location & material	Right Side Rear Quarter Panel, Steel
	Connection to tank	Rubber Hose
Fuel line (material)		Steel
Fuel hose (material)		Steel
Return line (material)		Not Applicable
Vapor line (material)		"
Extended range tank	Opt., n.a.	Not Applicable
	Capacity L (gallons)	
	Location & material	
	Attachment	
Auxiliary tank	Opt., n.a.	Not Applicable
	Capacity L (gallons)	
	Location & material	
	Attachment	
	Sictr switch or valve	
	Separate fill	

# MVMA Specifications

Vehicle Line Geo TRACKER  
 Model Year 1992 Issued 9-91 Revised(\*) \_\_\_\_\_

METRIC (U.S. Customary)

Engine Description  
 Engine Code

1.6 LITER L4 (97 CID)  
 ELECTRONIC FUEL INJECTION RPO LS5

## Vehicle Emission Control

Exhaust Emission Control	Type (air injection, engine modifications, other)		EFI + TWC + EGR
	Air injection	Pump or pulse	Not Applicable
		Driven by	"
		Air distribution (head, manifold, etc.,)	"
		Point of entry	"
	Exhaust Gas Recirculation	Type (controlled flow, open orifice, other)	Backpressure Controlled
		Exhaust source Point of exh.inj. (spacer, carb., manifold, other)	Manifold
	Catalytic Converter	Type	Single Bed
		Number of	2
		Location(s)	Under Floor
Volume L (cu.in)		1.4 (85)	
Substrate type		Monolith	
Noble metal type		Platinum (Pt), Rhodium (Rh)	
Crankcase Emission Control	Type (ventilates to atmosphere, induction system, other)		Induction System
	Energy source (manifold vacuum, carburetor, other)		Manifold Vacuum
	Discharges to (intake manifold, other)		Intake Manifold
	Air int.(breather cap, other)		Air Intake Case
Evaporative Emission Control	Vapor vented to (crankcase, canister, other)	Fuel tank	Canister
		Carburetor	Not Applicable
	Vapor storage provision		Canister
Electronic System	Closed loop (yes/no)		Yes
	Open loop (yes/no)		Yes

## Engine - Exhaust System

Type (single, single with cross-over, dual, other)		Single
Muffler no. & type (reverse flow, straight thru, separate resonator) Material & Mass kg (weight lbs.)		1 (Separate Resonator), Steel, 8.6 (18.9)
Resonator no. & type		1, Expansion
Exhaust pipe	Branch o.d., wall thickness	Inner:35-1.2 mm (1.38-0.05 in.), Outer:48.6-1.2 mm (1.91-0.05 in.)
	Main o.d., wall thickness	42.7 - 1.5 mm (1.68 - 0.06 in.)
	Matl. & Mass kg (wght.lbs.)	Stainless Steel & Aluminum Coated Steel, 7.5 (16.5)
Inter-mediate pipe	o.d. & wall thickness	42.7 - 1.2 mm (1.68 - 0.05 in.)
	Matl. & Mass kg (wght.lbs.)	Aluminum Coated Steel, 7.0 (15.4)
Tail pipe	o.d. & wall thickness	38.1 - 1.2 mm (1.45 - 0.05 in.)
	Matl. & Mass kg (wght.lbs.)	Aluminum Coated Steel, 1.5 (3.3)

# MVMA Specifications

Vehicle Line Geo TRACKER  
 Model Year 1992 Issued 9-91 Revised(\*) \_\_\_\_\_

## METRIC (U.S. Customary)

Engine Description	1.6 LITER L4 (97 CID)
Engine Code	ELECTRONIC FUEL INJECTION RPO LS5

### ○ Transmissions/Transaxle (Std., Opt., N.A.)

Manual 4-speed (manufacturer/country)	Not Applicable
Manual 5-speed (manufacturer/country)	Suzuki Motor Corporation/Japan, Std.
Manual 6-speed (manufacturer/country)	Not Applicable
Automatic (manufacturer/country)	Hydra-Matic, Strasbourgh, General Motors, France, Opt.
Auto. overdrive (manufacturer/country)	---

### Manual Transmission/Transaxle

Number of forward speeds		5
○ Gear ratios	1st	3.65
	2nd	1.95
	3rd	1.38
	4th	1.00
	5th	0.86
	6th	
	Reverse	3.67
Synchronous meshing (specify gears)		All Forward Gears
Shift lever location		Floor Mounted
Trans. case mat'l. & mass kg (lbs)*		Aluminum Die-Cast, 31.6 (69.7)
Lubricant	Capacity L (pt.)	1.5
	Type recommended	Gear Oil GL4
SAE Viscosity Number		75W-85, All Season, 75W-90 Available

### Clutch (Manual Transmission)

Clutch manufacturer		Daikin Manufacturing Co., Ltd.
Clutch type (dry, wet; single, multiple disc)		Dry Single Disc
Linkage (hyd., cable, rod, lever, other)		Cable
Max. pedal effort (nom. spring load) N (lbs.)	Depressed	120
	Released	75
Assist (spring, power/percent, nominal)		Spring
Type pressure plate springs		Diaphragm Spring
Total spring load (nominal) N (lbs.)		3,920
Clutch facing	Facing mfr. & mat'l. coding	Daikin Manufacturing Co. Ltd., HN603
	Facing mat'l. & construction	Non-Asbestos. Semi-Mold
	Rivets per facing	16
	Outside x inside dia. (nom.)	200 x 140 mm (7.87 x 5.51 in.)
	Total eff. area sq cm (sq in)	160
	Thickness (pressure plate side/fly wheel side)	3.5/3.5 mm (0.138/0.138 in.)
	Rivet depth (pressure plate side/fly wheel side)	1.3 - 1.9 (0.051-0.075 in.) / 1.3 - 1.9 mm (0.051-0.075 in.)
Engagement cushion method		Separate Cushion Type
Release bearing type & method lub.		Automatic Center Adjusting Type Without Grease Lubrication
Torsional damping method, springs, hysteresis		Spring Type

\* Includes shift linkage, lubricant, and clutch housing. If other specify.

# MVMA Specifications

Vehicle Line Geo TRACKER  
 Model Year 1992 Issued 9-91 Revised(\*)           

## METRIC (U.S. Customary)

Engine Description	1.6 LITER L4 (97 CID)
Engine Code	ELECTRONIC FUEL INJECTION RPO LS5

### Automatic Transmission/Transaxle

Trade Name		3-Speed Automatic
Type and special features (describe)		Torque Converter With Planetary Gears
Gear selector	Location (column, floor, other)	Floor Mounted
	Ltr./No. designation (e.g. PRND21)	P-R-N-D-2-L
	Shift interlock (yes, no, describe)	Yes
Gear ratios	1st	2.40 (Equivalent)
	2nd	1.47 "
	3rd	1.00 "
	4th	Not Applicable
	5th	
	6th	
Reverse		2.00 (Equivalent)
Max. upshift speed - drive range km/h (mph)		56.4 (35) [1-2], 101.9 (63) [2-3]
Max. kickdown speed - drive range km/h (mph)		44.2 (27) [2-1], 93.1 (58) [3-2]
Min. overdrive speed km/h (mph)		Not Applicable
Torque converter	Number of elements	3
	Max. ratio at stall	2.40:1
	Type of cooling (air, liquid)	Liquid
	Nominal diameter	245 mm (9.6 in.)
Capacity factor "K"		260
Lubricant	Capacity refill L (pt.)	5.1 (10.8)
	Type recommended	Dexron II
Oil cooler (std., opt., N.A., internal, external, air, liquid)		Radiator
Trans. mass kg (lbs) & case matl. **		Aluminum, 64.2 (141)

### All Wheel / 4 Wheel Drive (NOT APPLICABLE - 2 WHEEL DRIVE MODELS)

Desc. & type (part-time, full-time, 2/4 shift while moving, mech., elect., chain/gear, etc.)		Part-Time
Transfer case	Manufacturer and model	Suzuki Motor Corporation
	Type and location	Constant Mesh Helical Gear
Low-range gear ratio		1.82
System disconnect (describe)		Floor Shift
Center differential	Type (bevel, planetary, w or w/o viscous bias, torsen, etc.)	Not Applicable
	Torque split(% frt/rear)	"

\* Input speed / square root of torque.  
 \*\* Includes torque converter, lubricant and shift linkage

# MVMA Specifications

Vehicle Line Geo TRACKER  
 Model Year 1992 Issued 9-91 Revised(\*)

## METRIC (U.S. Customary)

Engine Description	1.6 LITER L4 (97 CID)
Engine Code	ELECTRONIC FUEL INJECTION RPO LS5

### Axle Ratio and Tooth Combinations (See 'Power Teams' for axle ratio usage)

Effec. final drv. ratio (or overall top gear ratio)		5.12 (Manual)	4.62 (Automatic)
Transfr ratio and method(chain,gear,etc)		1.00 (High Range), 1.82 (Low Range), Gear	
Front drive unit	Ring gear o.d.	175 mm (6.89 in.)	
	No. of teeth	Pinion	8
		Ring gear	37

### Front Drive Unit

Description (integral to trans., etc.)		Differential With Hypoid Gear And Taper Bearing
Limited slip differential (type)		None
Drive pinion	Type	Hypoid Gear
	Offset	23 mm (0.906 in.)
No. of differential pinions		2
Pinion/differential	Adjustment (shim, etc.)	Shim
	Bearing adjustment	Collapsible
Driving wheel bearing (type)		Taper Bearing
Lubricant	Capacity L (pt.)	1.0 (2.1)
	Type recommended	Hypoid Gear Oil GL-5
	SAE Viscosity Number	75W-80

### Axle Shafts - Front Wheel Drive

Manufacturer and number used		NTN Corporation	
Type (straight, solid bar, tubular, etc.)	Left	Solid Bar	
	Right	Solid Bar	
Outer diam. x length* x wall thickness	Manual transaxle	Left	22 x 310.5 mm (0.87 x 12.22 in.)
		Right	22 x 305.5 mm (0.87 x 12.03 in.)
	Automatic transaxle	Left	22 x 310.5 mm (0.87 x 12.22 in.)
		Right	22 x 305.5 mm (0.87 x 12.03 in.)
	Optional transaxle	Left	Not Applicable
		Right	"
Slip yoke	Type	"	
	Number of teeth	"	
	Spline o.d.	"	
Universal joints	Make and mfg. no.	Inner	NTN Corporation, 2
		Outer	NTN Corporation, 2
	Number used		4
	Type, size, plunge	Inner	Double Offset Joint DOJ82
		Outer	Rzeppa BJ82
	Attach (u-bolt, clamp, etc.)		Bolt & Clip
	Bearing	Type (plain, anti-friction)	Anti-Friction
		Lubrication (fitting, prepack)	Prepacked
Drive taken through (torque tube, arms or springs)		Lower: Control Arm, Upper: MacPherson Strut	
Torque taken through (torque tube, arms or springs)		Diff Mounting System	

\* Centerline to centerline of universal joints, or to centerline of attachment.

# MVMA Specifications

Vehicle Line Geo TRACKER  
 Model Year 1992 Issued 9-91 Revised(\*) \_\_\_\_\_

## METRIC (U.S. Customary)

Engine Description	1.6 LITER L4 (97 CID)
Engine Code	ELECTRONIC FUEL INJECTION RPO LS5

## Axle Ratio and Tooth Combinations (See 'Power Teams' for axle ratio usage)

Axle ratio (or overall top gear ratio)	5.12 (Manual)	4.62 (Automatic)
Ring gear o.d.	190 mm	
No. of teeth	Pinion	8
	Ring gear	37

## Rear Axle Unit

Description	Differential With Hypoid Gear And Taper Bearings	
Limited slip differential (type)	None	
Drive pinion	Type	Hypoid Gear
	Offset	27 mm (1.06 in.)
No. of differential pinions	4	
Pinion/differential	Adjustment (shim, etc.)	Shim
	Bearing adjustment	Collapsible
Driving wheel bearing (type)	Taper Bearing	
Lubricant	Capacity L (pt.)	2.2 (4.6)
	Type recommended	Hypoid Gear Oil GL-5
	SAE Viscosity Number	75W-80

## Propeller Shaft - Rear Wheel Drive

Manufacturer Type (straight tube, tube-in-tube, internal-external damper, etc.)		HAMANA PARTS CO., LTD., Straight Tube	
Outer diam. x length* x wall thickness	Manual 4-speed transmission	Not Applicable	
	Manual 5-speed transmission	Not Applicable	
	Manual 6-speed transmission		
	Overdrive	Not Applicable	
	Automatic transmission	Front: 38.1 x 506 x 3.2 mm (1.5 x 19.92 x 0.13 in.) Rear: 50.8 x 722 x 2.3 mm (2.0 x 28.43 x 0.09 in.)	
Inter-mediate bearing	Type (plain, anti-friction)	Not Applicable	
	Lub. (fitting, prepack)	"	
Slip yoke	Type	Involute Serration Hole	
	Number of teeth	26	
	Spline o.d.	27 mm (1.06 in.)	
Universal joints	Make and mfg. no.	Front	KOYO SEIKO CO., LTD.
		Rear	KOYO SEIKO CO., LTD.
	Number used	4	
	Type (ball and trunnion, cross)	Cross Type	
	Rr. attach(u-bolt, clamp, etc)	Flange and Bolts	
Bearing	Type (plain, anti-friction)	Needle Bearing	
	Lubrication (fitting, prepack)	Grease	
Drive taken through (torque tube, arms or springs)		Upper And Lower Arm	
Torque taken through (torque tube, arms or springs)		Engine Mounting System	

\* Centerline to centerline of universal joints, or to centerline of attachment.



# MVMA Specifications

METRIC (U.S. Customary)

Vehicle Line Geo TRACKER  
 Model Year 1992 Issued 9-91 Revised(\*) \_\_\_\_\_

Model Code/Description And/Or  
 Engine Code/Description

4WD MODELS

2WD MODELS

## Suspension - General Including Electronic Controls

Car leveling	Std./opt./not avail.	Not Applicable	
	Manual/automatic control		
	Type (air/hydraulic)		
	Primary/assist spring		
	Rear only/4 wheel leveling		
	Single/dual rate spring		
	Single/dual ride heights		
	Provision for jacking		
Shock absorber damping controls	Standard/option/not avail.	Not Applicable	
	Manual/automatic control		
	Number of damping rates		
	Type of actuation (manual/electric motor/air, etc.)		
	s e n s o r s	Lateral acceleration	
		Deceleration	
Acceleration			
Road surface			
Shock absorber (front & rear)	Type	Front & Rear: Double Action Telescopic	
	Make	Front: Showa & Sumbury Component Industry, Rear: TOKICO Mfg. Corp.	
	Piston diameter	Ft: 32 mm (1.26 in.), Rr: 25 mm (0.98 in.)	
	Rod diameter	Ft: 22 mm (0.87 in.), Rr: 12.5 mm (0.49 in.)	

## Suspension - Front

Type and description		MacPherson Strut (Separate Coil Spring)	
Travel	Full jounce (define load condition)	100 mm (3.94 in.)	90 mm (3.54 in.)
	Full rebound	60 mm (2.36 in.)	70 mm (2.76 in.)
O Spring	Type (coil, leaf, other & matl)	Coil, Steel	
	Insulators (type & matl)	Rubber	
	Size (Leaf: length & width; Coil: design height & i.d.; Bar: length & diameter)	227 x 83 mm (8.93 x 3.27 in.)	220 x 83 mm (8.66 x 3.27 in.)
	Spring rate N/mm (lb./in.)	79.4 (452.8)	
O Stabilizer	Rate @ wheel N/mm (lb./in.)	27.4 (156.5)	
	Type (link, linkless, frmless)	Link	
	Material & O.D. bar/tube, wall thickness	Steel Tube, 24.2 mm (0.95 in.), 3.0 mm (0.12 in.)	

## Suspension - Rear

Type and description		Rigid Axle With Lower Trailing Arm & Upper A Shape Arm	
Travel	Full jounce (define load condition)	110 mm (4.33 in.)	100 mm (3.94 in.)
	Full rebound	50 mm (1.97 in.)	
O Spring	Type (coil, leaf, other & matl)	Coil, Steel	
	Size (Leaf: length & width; Coil: design height & i.d.; Bar: length & diameter)	250 x 83.7 mm (9.84 x 3.3 in.)	238 x 84.1 mm (9.37 x 3.31 in.)
	Spring rate N/mm (lb./in.)	27.4 (156.5)	
	Rate @ wheel N/mm (lb./in.)	27.4 (156.5)	
	Insulators (type & material)	Rubber	
	If leaf	No. of leaves	Not Applicable
Shackle (comp or tens)		"	
O Stabilizer	Type (link, linkless, frmless)	"	
	Material & O.D. bar/tube, wall thickness	"	
Track bar (type)		"	

# MVMA Specifications

METRIC (U.S. Customary)

Vehicle Line Geo TRACKER  
 Model Year 1992 Issued 9-91 Revised(\*)           

Model Code/Description And/Or Engine Code/Description Brakes - Service	CONVERTIBLE HARDTOP
--	------------------------

Description		Hydraulic, Front: Floating Caliper Rear: Leading Trailing Shoe	
Manufacturer and brake type (std., opt., n.a.)	Front (disc or drum)	TOKICO LTD., Disc	
	Rear (disc or drum)	NISSHINBO CO., LTD., Drum	
Valving type(prop, delay, metering, other)		Proportioning	
Power brake (std., opt., n.a.)		Standard	
Booster type(rmt, intgrl, vac., hyd., etc.)		Vacuum	
Vacuum	Source (inline, pump, etc.)	Inline (Intake Manifold)	
	Reservoir (volume cu. in.)	Not Applicable	
	Pump-type	"	
Traction Control	Operational speed range	Not Applicable	
	Type (engine or brake intervention)		
Antilock device	Front/rear (std., opt., n.a.)	Rear, Standard	
	Manufacturer	Kelsey-Hayes	
	Type (electronic, mech.)	Electronic	
	Number sensors or circuits	1	
	No. antilock hyd. circuits	1	
	Integral or add-on system	Add-On System	
	Yaw control (yes, no)	No	
Hydraulic power source		Not Applicable	
Effective area sq. cm. (sq. in.)*		135/287 (21/44)	
Gross Lng area sq. cm. (sq. in.)**(F/R)		140/287 (22/44)	
Swept area sq. cm. (sq. in.)**(F/R)		1322/470 (205/73 in.)	
Rotor	Outer working diameter	F/R 290/- mm (11.42/- in.)	
	Inner working diameter	F/R 205/- mm (8.07/- in.)	
	Thickness	F/R 10/- mm (0.39/- in.)	
	Matl & type (vented/std)	F/R Cast Iron, Solid/-	
Drum	Diameter & width	F/R -/220 x 34 mm (-/8.66 x 1.34 in.)	
	Type and material	F/R -/Cast Iron, Solid	
Wheel cylinder bore		48.1/23.81 mm (1.89/0.94 in.)	
Master cylinder	Bore/stroke	F/R 22.22/31.0 mm (0.87/1.22 in.)	
Pedal arc ratio		4.5:1	
Line pressure at 445 N (100 lb.) pedal load kPa (psi)		9700	
Lining clearance		F/R Self-Adjusting/Self-Adjusting	
Brake lining	Front wheel	Bonded or riveted	Bonded
		Rivet size	Not Applicable
		Manufacturer	JAPAN BRAKE INDUSTRIAL CO., LTD.
		Lining code ****	JB KC 80FE
		Material	Resin Mold
		**** Pri. or out-brd	99 x 42 x 10 mm (3.90 x 1.65 x 0.39 in.)
		Size Sec. or in-brd	99 x 42 x 10 mm (3.90 x 1.65 x 0.39 in.)
	Shoe thcknss. (no lng)		5 mm (0.20 in.)
	Rear wheel	Bonded or riveted	Bonded
		Manufacturer	JAPAN BRAKE INDUSTRIAL CO., LTD.
		Lining code ****	JB NL 60FF
		Material	Resin Mold
		**** Pri. or out-brd	211 x 34 x 5.5 mm (8.31 x 1.34 x 0.22 in.)
		Size Sec. or in-brd	211 x 34 x 5.5 mm (8.31 x 1.34 x 0.22 in.)
Shoe thcknss (no lng)		2 mm (0.08 in.)	

\* Excludes rivet holes, grooves, chamfers, etc.      \*\*Includes rivet holes, grooves, chamfers, etc.  
 \*\*\*\* Total swept area for four brakes. (Drum brake: Widest lining contact width for each brake x its contact circum.)  
 (Disc brake: Square of Outer Working Dia. - Square of inner Working Dia. X Pi/2 for each brake.)  
 \*\*\*\*\* Size for drum brakes includes length x width x thickness.  
 \*\*\*\*\* Manufacturer I.D., catalog for formulation designation and coefficient of friction classification.

# MVMA Specifications

Vehicle Line Geo TRACKER  
 Model Year 1992 Issued 9-91 Revised(\*) \_\_\_\_\_

METRIC (U.S. Customary)

Model Code/Description And/Or Engine Code/Description	4WD MODELS	2WD MODELS
---	------------	------------

## Tires And Wheels (Standard)

Tires	Size (load range, ply)	P205/75R15	P195/75R15	
	Type (bias, radial, etc.)	Radial		
	Inflation pressure (cold) for recommended max. vehicle load	Front kPa (psi)	160 (23)	
		Rear kPa (psi)	160 (23)	
	Rev/mile-at 70 km/h(45mph)	760		
Wheels	Type & material	Drop Center, Steel		
	Rim (size & flange type)	15 x 5.5 JJ		
	Wheel offset	25 mm (0.98 in.)		
	Attachment	Type(bolt,stud)	Stud	
		Circle diameter	139.7 mm (5.50 in.)	
Number & size		5 x M12		
Spare	Tire and wheel	Same Size		
	Storage position & location (describe)	Vertical, Outside Of Back Door		

## Tires And Wheels (Optional)

Tire size (load range, ply)	Not Applicable
Type (bias, radial, steel, nylon, etc.)	Not Applicable
Wheel (type & material)	Drop Center, Aluminum Alloy
Rim (size, flange type and offset)	15 x 5.5 JJ, 25 mm
Tire size (load range, ply)	Not Applicable
Type (bias, radial, steel, nylon, etc.)	"
Wheel (type & material)	"
Rim (size, flange type and offset)	"
Tire size (load range, ply)	"
Type (bias, radial, steel, nylon, etc.)	"
Wheel (type & material)	"
Rim (size, flange type and offset)	"
Tire size (load range, ply)	"
Type (bias, radial, steel, nylon, etc.)	"
Wheel (type & material)	"
Rim (size, flange type and offset)	"
Spare tire and wheel size (if configuration is different than road tire or wheel, describe optional spare tire and/or wheel location & storage position)	Not Applicable

## Brakes - Parking

Type of control	Lever - Hand Operated	
Location of control	Between Front Seat	
Operates on	Rear Service Brake	
If separate from service brakes	Type(internal or external)	Not Applicable
	Drum diameter	"
	Lining size (length x width x thickness)	"

# MVMA Specifications

Vehicle Line Geo TRACKER  
 Model Year 1992 Issued 8-91 Revised(\*)           

METRIC (U.S. Customary)

Model Code/Description And/OR  
 Engine Code/Description

CONVERTIBLE	HARDTOP
-------------	---------

## Steering

Manual (std., opt., n.a.)		Standard		
Power (std., opt., n.a.)		Optional		
<input type="radio"/> Speed-sensitive (std., opt., n.a.)		Not Applicable		
<input type="radio"/> 4-wheel steering (std., opt., n.a.)		Not Applicable		
Adjustable steering wheel/ column (tilt, telescope, other)	Type	Tilt		
	Manufacturer	Douglas Autotech Corp.		
	(std., opt., n.a.)	Optional		
Wheel diameter ** (W9) SAE J1100	Manual	390 mm (15.35 in.)		
	Power	Optional		
Turning diameter m (ft.)	Out-side front	Wall to wall (l. & r.)	10.5 (34.44)	
		Curb to curb (l. & r.)	9.8 (32.15)	
	In-side rear	Wall to wall (l. & r.)	Not Applicable	
		Curb to curb (l. & r.)	"	
Scrub Radius *		12 mm (0.47 in.)		
Manual	Gear	Type	Recirculating Ball	
		Manufacturer	NIPPON SEIKO K.K.	
		Ratios	Gear 18.5 - 21.0 (Variable) Overall 21.7	
	No. wheel turns(stop to stop)		3.8	
	Type (coaxial, elec. hyd., etc.)		Hydraulic	
Power	Manufacturer		KOYO SEIKO CO., LTD.	
	Gear	Type	Recirculating Ball	
		Ratios	Gear	17.5
			Overall	19.4
	Pump (drive)		Belt	
	No. wheel turns(stop to stop)		3.4	
Linkage	Type		Parallel Linkage	
	Location (front or rear of wheels, other)		Front	
	Tie Rods (one or two)		2	
Steering axis	Inclination at camber (deg.)		31	
	Bear-ings (type)	Upper	Needle Bearing	
		Lower	Ball Bearing	
		Thrust	Not Applicable	
Steering spindle/knuckle & joint type		Serrated Shaft		

\* The horizontal distance in the front elevation between wheel centerline and kingpin (ball joint) axis at ground.  
 \*\* See Page 22.

# MVMA Specifications

Vehicle Line Geo TRACKER  
 Model Year 1992 Issued 9-91 Revised(\*) \_\_\_\_\_

METRIC (U.S. Customary)

Model Code/Description And/Or  
 Engine Code/Description

CONVERTIBLE	HARDTOP
-------------	---------

## Wheel Alignment

Wheel	Service	Parameter	Value
Front wheel at curb mass (wt.)	Service checking	Caster (deg.)	1.5
		Camber (deg.)	0.5
		Toe-in outside track - mm (in.)	2 - 6 mm (0.08 - 0.24 in.)
	Service reset*	Caster (deg.)	Not Applicable
		Camber (deg.)	"
		Toe-in - mm(in.)	Adjustable
	Periodic M.V. inspection	Caster (deg.)	1.5 (+/-) 1
		Camber (deg.)	0.5 (+/-) 1
		Toe-in - mm(in.)	2 - 6 mm (0.08 - 0.24 in.)
Rear wheel at curb mass (wt.)	Service checking	Camber (deg.)	0
		Toe-in outside track - mm (in.)	0
		Camber (deg.)	Not Applicable
	Service reset*	Toe-in - mm(in.)	"
		Camber (deg.)	0 (+/-) 1
	Periodic M.V. inspection	Toe-in - mm(in.)	0 (+/-) 2

\* Indicates pre-set, adjustable, trend set or other.

## Electrical - Instruments and Equipment

Speedometer	Type (analog, digital, std., opt.)	Analog
	Trip odometer (std., opt., n.a.)	Standard
Head-up display	Std., opt., not avail.	Not Applicable
	Type - Secondary, Opto-electronic	Not Applicable
	Speedometer Digital	Not Applicable
	Status/warn. indicators - Turn signals, high beam, low fuel, check gauges	Not Applicable
	Brightness control Day/night mode, adj.	Not Applicable
EGR maintenance indicator		Not Applicable
Charge indicator	Type	Not Available
	Warning device (light, audible)	Tell-Tall Warning Light
Temperature indicator	Type	Analog Gauge With Pointer
	Warning device	Not Applicable
Oil pressure indicator	Type	Not Applicable
	Warning device	Tell-Tale Warning Light
Fuel indicator	Type	Analog Gauge With Pointer
	Warning device	Not Applicable
Windshield wiper	Type (standard)	Electric 2-Speed
	Type (optional)	Intermittent
	Blade length	434 mm (17.09 in.)
	Swept area sq cm (sq in)	5,308 (17.09)
Windshield washer	Type (standard)	Electric, Lever Control: PULL
	Type (optional)	Not Applicable
	Fluid level indicator	"
Rear window wiper, wiper/washer (std., opt., n.a.)		Optional
Horn	Type	Electric Resonator
	Number used	1
Other		

# MVMA Specifications

Vehicle Line Geo TRACKER  
 Model Year 1992 Issued 9-91 Revised(\*) \_\_\_\_\_

METRIC (U.S. Customary)

Engine Code/Description 1.6 LITER L4 (97 CID)  
ELECTRONIC FUEL INJECTION RPO LS5

## Electrical - Supply System

Battery	Manufacturer	DELCO REMY
	Model, std., (opt.)	Standard 26-500
	Voltage	12
	Amps at 0 deg F cold crnk	500
	Minutes-reserve capacity	75
	Amps/hrs. - 20 hr. rate	45
	Location	RH Side Of Engine Compartment
Alternator	Manufacturer	mitsubishi electric corp.
	Rating (idle/max. rpm)	55
	Ratio (alt. crank/rev.)	2.36:1
	Output at idle (rpm, park)	30 (800)
	Optional (type & rating)	Not Applicable
Regulator	Type	Integral With Alternator

## Electrical - Starting System

Motor	Manufacturer	MITSUBISHI ELECTRIC CORP.
	Current drain 0 deg C (F)	200 A max.
	Power rating kw (hp)	MT: 1.2 (1.6), AT: 1.4 (1.9)
Motor drive	Engagement type	Positive Shift Solenoid
	Pinion engages from (front, rear)	Front

## Electrical - Ignition System

Type	Electronic (std, opt, n.a.)	Not Applicable	
	Other (specify)	High Energy Ignition (Integral With Distributor)	
Coil	Manufacturer	Mitsubishi Electric Corp.	
	Model	J002T01671	
	Current	Engine stopped-A	0
		Engine idling - A	1.5 max.
Spark plug	Manufacturer	NGK, NIPPON DENSO	
	Model	BPR5ES, W16EXR-U	
	Thread (mm)	M14 x 1.25	
	Tightening torque Newton meters (lb. ft.)	20 - 30 (15 - 22)	
	Gap	0.8 mm (0.03 in.)	
	Number per cylinder	1	
Distributor	Manufacturer	Mitsubishi Electric Corp.	
	Model	T2T53471	

## Electrical - Suppression

Locations & type	High Tension Cord With Resistor Spark Plug With Resistor
------------------	---

# MVMA Specifications

Vehicle Line Geo TRACKER  
 Model Year 1992 Issued 9-91 Revised(") \_\_\_\_\_

METRIC (U.S. Customary)

Model Code/Description

CONVERTIBLE

HARDTOP

## Body

Structure	Body With Chassis Frame
Bumper System Front - Rear	Front: Energy Absorption Type By P.P. Foam Rear: P.P. Skin With Steel Core
Anti-Corrosion Treatment	1. Surface Treated Steel Plates 2. Vinyl Chloride Coating (Bottom/Side Of Floor)

## Body - Miscellaneous Information

Type of finish (lacquer, enamel, other)	Enamel	
Hood	Material & mass	Steel, 10.8 kg (23.8 lbs.)
	Hinge location (front, rear)	Rear
	Type (counterbalance, prop)	Prop
	Release control (int., ext.)	Internal And External
Trunk lid	Material & mass	Not Applicable
	Type (counterbalance, other)	"
	Internal release control (elec., mech., n.a.)	"
Hatch-back lid	Material & mass	Not Applicable
	Type (counterbalance, other)	"
	Internal release control (elec., mech., n.a.)	"
Tailgate	Material & mass	Steel, 13.8 kg (30.4 lbs.)
	Type (drop, lift, door)	Door
	Internal release control (elec., mech., n.a.)	Not Applicable
Vent window control (crank, friction, pivot, power)	Front	"
	Rear	Pivot
Window regulator type (cable, tape, flex drive, etc.)	Front	Cable
	Rear	Not Applicable
Seat cushion type (e.g., 60/40, bucket, bench wire, foam, etc.)	Front	Semi Bucket
	Rear	Bench Bucket
	3rd seat	Not Applicable
Seat back type (e.g., 60/40, bucket, bench, wire, foam, etc.)	Front	Semi Bucket
	Rear	Bench Bucket
	3rd seat	Not Applicable

## Frame

Type and description (separate frame, unitized frame, partially-unitized frame)	Separate Frame
---	----------------

# MVMA Specifications

Vehicle Line Geo TRACKER  
 Model Year 1992 Issued 9-91 Revised(\*) \_\_\_\_\_

METRIC (U.S. Customary)

Model Code/Description

CONVERTIBLE

HARDTOP

## Restraint System

Seating Position			Left	Center	Right
Active	Type & description (lap & shoulder belt, lap belt, etc.)	First seat	Lap & Shoulder Belt ELR, Standard		Lap & Shoulder Belt ELR-ALR, Standard
		Second seat	Lap & Shoulder Belt ELR-ALR, Standard		Lap & Shoulder Belt ELR-ALR, Standard
	Standard/ optional	Third seat			
Passive	Type & description (air bag, motorized-2-point belt, fixed belt, knee bolster, manual-lap belt)	First seat			
		Second seat			
	Standard/ optional	Third seat			

Glass		SAE Ref No		
Windshield glass exposed surface area sq. cm. (sq. in.)	S1	8,315 (1,288)		
Side glass exposed surface area sq. cm. (sq. in.) - total 2- sides	S2	8,540 (1,324)		17,040 (2,641)
Backlight glass exposed surface area sq. cm. (sq. in.)	S3	Not Applicable		5,472 (848)
Total glass exposed surface area sq. cm. (sq. in.)	S4	16,855 (2,612)		30,827 (4,777)
Windshield glass (type)		Laminated Glass		
Side glass (type)		Tempered Glass		
Backlight glass (type)		Tempered Glass		

## Headlamps

Description - sealed beam, halogen, replaceable bulb, etc.	Halogen, Replaceable Bulb
Shape	Composite
Lo-beam type (2A1, 2B1, 2C1, etc.)	
Quantity	2
Hi-beam type (1A1, 2A1, 1C1, 2C1, etc.)	
Quantity	2



# MVMA Specifications

Vehicle Line Geo TRACKER  
 Model Year 1992 Issued 9-91 Revised \_\_\_\_\_

METRIC (U.S. Customary)

Engine Code/Description

CONVERTIBLE

HARDTOP

## o Climate Control System

Air conditioning (std., opt., man., auto.)		Optional, Manual
Condenser	Type	Corrugated Fin
	Eff. face area (sq. mm.)	146,500
	Fins per inch	6.35
Evaporator	Type	Single Tank Laminated
	Eff. face area (sq. mm.)	40,300
	Fins per inch	7.1
Heater Core	Material	Copper
	Eff. face area (sq. mm.)	19,670
	Fins per inch	12.7
Compressor	Type	Swash
	Displacement (cc)	81.6
	Manufacturer	Nippon Denso Co., Ltd.
	A/C pulley ratio	1.33
Accumulator	Type	Not Applicable
	Height (mm.)	"
	Diameter (mm.)	"
Receiver	Type	Dryer, Sight Glass, Safety Device
	Height (mm.)	187
	Diameter (mm.)	60
Refrigerant control (CCOT, TVS, etc.)		Thermostatic Expansion Valve
Heater water valve (yes / no)		No
Refrigerant (R-12, R-134a, etc.)		R-12
Charge level (lbs. - oz.)		1.43 lbs.
Cold engine lockout switch (yes / no)		No
Wide open throttle cutout switch (yes / no)		No

# MVMA Specifications

Vehicle Line Geo TRACKER  
 Model Year 1992 Issued 9-91 Revised(\*) \_\_\_\_\_

METRIC (U.S. Customary)

Model Code/Description

CONVERTIBLE

HARDTOP

## Convenience Equipment (standard, optional, n.a.)

Clock (digital, analog)	Optional, Digital, Integral With Radio	
Compass / thermometer	Not Applicable	
Console (floor, overhead)	Standard, Floor (4WD Models)	
Defroster, elec. backlight	Not Applicable <span style="float: right;">Optional</span>	
Electronic	Diagnostic monitor (integrated, individual)	"
	Instrument cluster (list instruments)	"
	Keyless entry	"
	Tripminder (avg. spd, fuel)	"
	Voice alert (list items)	"
	Other	"
Fuel door lock (remote, key, electric)	"	
Lamps	Auto head on/off delay, dimming	"
	Cornering	"
	Courtesy (map, reading)	Standard, Map Lamp 1
	Door lock, ignition	Not Applicable
	Engine compartment	"
	Fog	"
	Glove compartment	"
	Trunk	"
	Illuminated entry system (list lamps, activation)	"
	Other	"
Mirrors	Day / night (auto, man.)	Standard, Manual
	L.H. (remote, pwr., heated)	Standard, Manual
	R.H. (convex, rmt, pwr, htd)	Standard, Convex
	Visor vanity (RH/LH illum.)	Not Applicable
Navigation system (describe)	"	
Prkg. brake—auto release (warn. light)	"	

# MVMA Specifications

Vehicle Line Geo TRACKER  
 Model Year 1992 Issued 9-91 Revised(\*)

METRIC (U.S. Customary)

Model Code/Description

CONVERTIBLE	HARDTOP
-------------	---------

## Convenience Equipment (standard, optional, n.a.)

Power equipment	Deck lid(release, pull down)		Not Applicable
	Door locks (manual, auto., describe system)		"
	Seats	2 - 4 - 6 way, etc.	"
		Reclining(R.H., L.H.)	"
		Memory (R.H., L.H., preset, recline)	"
		Support (lumbar, hip, thigh, etc.)	"
		Heated (R.H., L.H., other)	"
	Side windows		"
	Vent windows		"
	Rear windows		"
Radio systems	Antenna (location, whip, w/shield, power)		Left Front Pillar, Whip
	Stan.		Antenna Only
	Opt.	AM, FM, stereo, tape, compact disc, graphic equalizer, theft deterrent, radio prep package, headphone jacks, etc.	AM/FM, ETR, Stereo AM/FM, ETR, Stereo With Cassette Tape Deck
	Speaker (number, location)		Opt. 2: I.P. Mounted. 2: Rear Quarter Trim
	Roof: open air or fixed (flip-up, sliding, 'T')		Canvas, Flip-up
Speed control device		Not Applicable	
Speed warn. dev. (light, buzzer, etc.)		"	
Tachometer (rpm)		Standard	
Telephone system (describe)		Not Applicable	
Theft deterrent system		Steering Lock - Type	

## Trailer Towing

Towing capable	Yes / No	Yes
Engine/transmission/axle	Std / Opt	Standard
Tow class (I, II, III)*	Std / Opt	I, Optional
Max. gross trailer wgt. (lbs.)	Std / Opt	1,000
Max. trailer tongue load (lbs.)	Std / Opt	100
Towing package available	Yes / No	Yes

\* Class I - 2,000 lbs. Class II - 3,500 lbs. Class III - 5,000 lbs.

# MVMA Specifications

Vehicle Line Geo TRACKER  
 Model Year 1992 Issued 9-91 Revised(\*)

## METRIC (U.S. Customary)

### Vehicle Dimensions See Key Sheets for definitions

All dimensions to ground are for comparative purposes only. Dimensions are to be shown for all base body models of each vehicle line. SAE Ref. no. refers to the definition published in SAE Recommended Practice J1100 'Motor Vehicle Dimensions,' unless otherwise specified.

#### Model Code/Description

CONVERTIBLE

HARDTOP

Width	SAE Ref. No.		
Tread (front)	W101	1,395 (54.92)	
Tread (rear)	W102	1,400 (55.12)	
Vehicle width	W103	1,630 (64.17)	
Body width at Sg RP (front)	W117	1,566 (61.65)	
Vehicle width (front doors open)	W120	3,450 (135.83)	
Vehicle width (rear doors open)	W121	Not Applicable	
Tumble-home (deg.)	W122	15.8	
Outside mirror width	W410	1,820 (71.65)	

Length	SAE Ref. No.		
Wheelbase	L101	2,200 (86.61)	
Vehicle length	L103	3,620 (142.52)	
Overhang (front)	L104	655 (25.79)	
Overhang (rear)	L105	765 (30.12)	
Upper structure length	L123	2,285 (89.96)	2,301 (90.59)
Rear wheel C/L 'X' coordinate	L127	1,840 (72.44)	

Height **	SAE Ref. No.		
Passenger distribution (front/rear)	PD1,2,3	2/2	**
Trunk/cargo load		1,595 (62.79)	**
Vehicle height	H101	1,665 (65.55)	
Cowl point to ground	H114	1,061 (41.77)	1,062 (41.81)
Deck point to ground	H136	---	
Rocker panel-front to ground	H112	246 (9.69)	247 (9.72)
Rocker panel-rear to ground	H111	228 (8.98)	230 (9.06)
Windshield slope angle (deg.)	H122	46.2	
Backlight slope angle (deg.)	H121	25	13.6

Ground Clearance **	SAE Ref. No.		
Front bumper to ground	H102	323 (12.72)	
Rear bumper to ground	H104	240 (9.45)	244 (9.61)
Bumper to ground front at curb mass (wt.)	H103	333 (13.11)	
Bumper to ground rear at curb mass (wt.)	H105	327 (12.87)	
Angle of approach (deg.)	H106	44	
Angle of departure (deg.)	H107	34	
Ramp breakover angle (deg.)	H147	18	
Axis differential to ground (front/rear)	H153	215/200 (8.46/7.87)	
Min. running ground clearance	H156	200 (7.87)	
Location of min. run. grd. clear.		Front Differential	

\*\* All Vehicle Height And Ground Clearance Are Made Using EPA Loaded Vehicle Weight, Loading Conditions.

EPA Loaded Vehicle Weight is the Base Vehicle Weight Plus All Coolant and Fluids Necessary For Operation Plus 100% Of The Fuel Capacity, Plus The Weight Of All Options And Accessories Which Weigh Three Pounds Or More And Which Are Sold On At Least 33% Of The Car Line, Plus Two Occupants.

All Linear Dimensions Are In Millimeters (Inches)

# MVMA Specifications

Vehicle Line Geo TRACKER  
 Model Year 1992 Issued 9-91 Revised(\*)

## METRIC (U.S. Customary) Vehicle Dimensions

See Key Sheets for Definitions

### Model Code/Description

CONVERTIBLE

HARDTOP

### Front Compartment

#### SAE Ref. No.

SgRP front, 'X' coordinate	L31	1,085 (42.71)	
Effective head room	H61	1,004 (39.53)	1,017 (40.04)
Max. eff. leg room (accelerator)	L34	1,069 (42.09)	
SgRP to heel point	H30	325 (12.80)	
SgRP to heel point	L53	820 (32.28)	
Back angle (deg.)	L40	20	
Hip angle (deg.)	L42	95.5	
Knee angle (deg.)	L44	122	
Foot angle (deg.)	L46	80	
Design H-point front travel	L17	180 (7.09)	
Normal driving & riding seat track trvl.	L23	180 (7.09)	
Shoulder room	W3	STD: 1,325 (52.17), LSi: 1,310 (51.57)	
Hip room	W5	STD: 1,316 (51.81), LSi: 1,310 (51.57)	
*** Upper body opening to ground	H50	1,480 (58.27)	
Steering wheel maximum diameter*	W9	390 (15.35)	
Steering wheel angle (deg.)	H18	31	
Accel. heel pt. to steer. whl. cntr	L11	337 (13.27)	
Accel. heel pt. to steer. whl. cntr	H17	715 (28.15)	
Undepressed floor covering thickness	H67	15 (0.59)	

Front Compartment Int. Dim. Are Measured With The Seating Ref. Pt.

(SgRP) 0 mm Forward And 0 mm Upward of Rearmost Position.

### Rear Compartment

SgRP point couple distance	L50	700 (27.56)	
Effective head room	H63	990 (38.27)	967 (38.08)
Min. effective leg room	L51	804 (31.65)	
SgRP (second to heel)	H31	385 (15.16)	
Knee clearance	L48	101 (3.98)	
Shoulder room	W4	1,275 (50.20)	
Hip room	W6	1,064 (41.89)	
*** Upper body opening to ground	H51	Not Applicable	
Back angle (deg.)	L41	20	
Hip angle (deg.)	L43	92	
Knee angle (deg.)	L45	80	
Foot angle (deg.)	L47	98	
Depressed floor covering thickness	H73	15 (0.59)	

### Luggage Compartment

Usable luggage capacity L (cu. ft.)	V1	134.3 (4.74)	145.7 (5.15)
*** Liftover height	H195	687 (27.05)	

### Interior Volumes (EPA Classification)

Vehicle class		Special Purpose Vehicle
Interior volume index (cu. ft.)**		87.04
Trunk / cargo index (cu. ft.)		Not Applicable

\* See page 14.

\*\* Includes passenger and trunk / cargo index - see definition page 32.

\*\*\* EPA Loaded Vehicle Weight, Loading Conditions

All Linear Dimensions Are In Millimeters (Inches)

# MVMA Specifications

Vehicle Line Geo TRACKER  
 Model Year 1992 Issued 9-91 Revised(\*) \_\_\_\_\_

## METRIC (U.S. Customary) Vehicle Dimensions

See Key Sheets for Definitions

Model Code/Description

CONVERTIBLE

HARDTOP

### Station Wagon / MPV\*\* - Third Seat

SAE Ref. No. (NOT APPLICABLE)

	SAE Ref. No.	
Seat facing direction	SD1	
SgRP couple distance	L85	
Shoulder room	W85	
Hip Room	W88	
Effective leg room	L86	
Effective head room	H86	
SgRP to heel point	H87	
Knee clearance	L87	
Back angle (deg.)	L88	
Hip angle (deg.)	L89	
Knee angle (deg.)	L90	
Foot angle (deg.)	L91	

### Station Wagon / MPV\*\* Cargo Space

	SAE Ref. No.		
Cargo length (open front)	L200	---	
Cargo length (open second)	L201	---	
Cargo length (closed front)	L202	STD: 793(31.22) LSi: 787(30.98)	STD: 788(31.02) LSi: 782(30.78)
Cargo length (closed second)	L203	STD: 320(12.60) LSi: 316(12.44)	STD: 315(12.40) LSi: 311(12.24)
Cargo length at belt (front)	L204	STD: 707(27.83) LSi: 662(26.06)	STD: 702(27.63) LSi: 657(25.86)
Cargo length at belt (second)	L205	STD: 196(7.71) LSi: 178(7.01)	STD: 191(7.51) LSi: 173(6.81)
Cargo width (wheelhouse)	W201	1,060 (41.73)	
Rear opening width at floor	W203	1,110 (43.70)	
Opening width at belt	W204	1,112 (43.78)	
Min. rear opening width above belt	W205	900 (35.43)	935 (36.8)
Cargo height	H201	1,010 (39.76)	
Rear opening height	H202	870 (32.25)	
* Tailgate to ground height	H250	645 (25.39)	
Front seat back to load floor height	H197	STD: 750 (29.53), LSi: 765 (30.12)	
Cargo volume index cu. m. (cu. ft.)	V2	0.91 (32.13)	0.904 (31.92)
Hidden cargo vol. index cu. m. (cu. ft.)	V4	Not Applicable	
Cargo volume index--rear of 2-seat	V10	0.252 (8.89)	0.246 (8.68)
○ Cargo volume index**	V6	878 L (31.0 cu. ft.)	890 L (31.4 cu. ft.)
○ Cargo width at floor**	W500	1,280 (50.39)	
○ Maximum cargo height**	H505	970 (38.19)	990 (38.98)

### Hatchback - Cargo Space

(NOT APPLICABLE)

	SAE Ref. No.	
Cargo length at front seatback height	L208	
Cargo length at floor (front)	L209	
Cargo length at second seatback height	L210	
Cargo length at floor (second)	L211	
Front seatback to load floor height	H197	
Second seatback to load floor height	H198	
Cargo volume index cu. m. (cu. ft.)	V3	
Hidden cargo vol. index cu. m. (cu. ft.)	V4	
Cargo volume index--rear of 2-seat	V11	

\* EPA Loaded Vehicle Weight, Loading Conditions

\*\* MPV - Multipurpose Vehicle

All Linear Dimensions Are In Millimeters (Inches)

# MVMA Specifications

Vehicle Line Geo TRACKER  
 Model Year 1992 Issued 9-91 Revised(\*) \_\_\_\_\_

METRIC (U.S. Customary)

Model Code/ Description	CONVERTIBLE HARDTOP
----------------------------	------------------------

## Vehicle Fiducial Marks

Fiducial Mark Number*	Define Coordinate Location
Front	Front: Center Of 20 mm Dia. Hole On "Side Frame Center".
Rear	Rear: Center Of 7 mm Dia. Hole On "Reinforcement Side Frame Center End".
NOTE: Provide 3 of 4 Fiducial Mark Locations	
Front	W21** 373/-373 (14.69/-14.69)
	L54** -58 (-2.28)
	H81** -67 (-2.64)
	H161** 218 (8.58)
	*** H163** 207 (8.15)
Rear	W22** 405/-405 (15.94/-15.94)
	L55** 1,560 (61.42)
	H82** -20 (-0.79)
	H162** 265 (10.43)
	*** H164** 247 (9.72)

- \* Reference - SAE Recommended Practice, J182, Motor Vehicle Fiducial Marks.
  - \*\* Reference - SAE Recommended Practice J1100 - Motor Vehicle Dimensions.
  - \*\*\* EPA Loaded Vehicle Weight, Loading Conditions
- All Linear Dimensions Are In Millimeters (Inches)







**MVMA Specifications**  
**METRIC (U.S. Customary)**

**Exterior Vehicle And Body Dimensions – Key Sheet**

**Exterior Width**

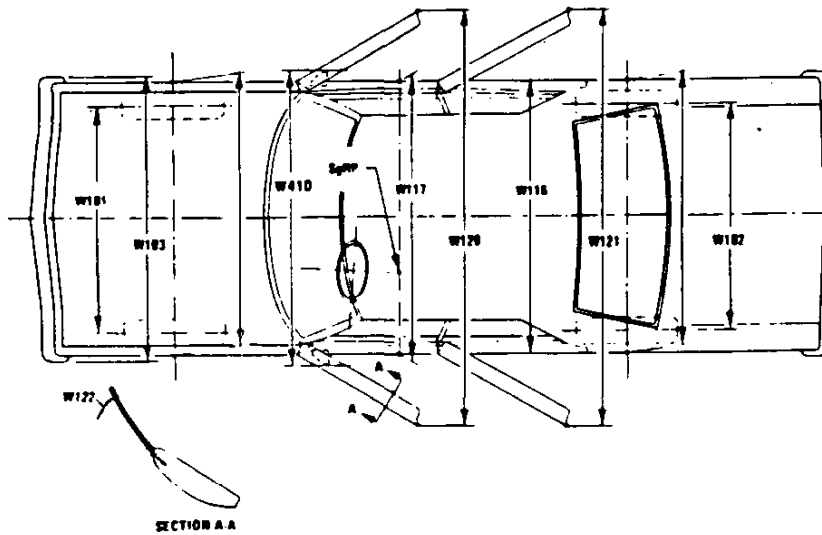

**Exterior Length & Height**

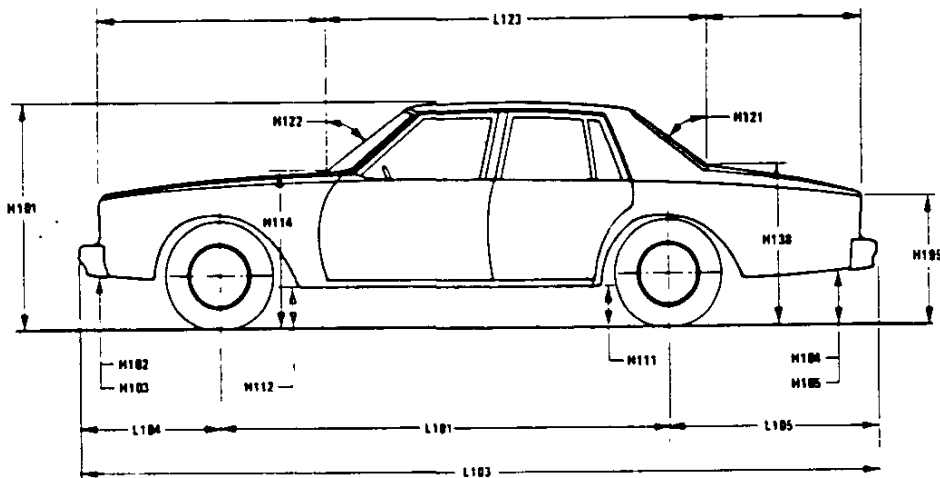

**Exterior Ground Clearance**

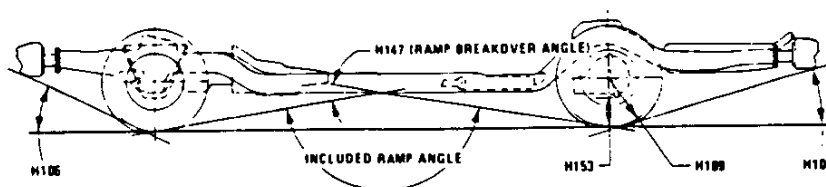

# MVMA Specifications Form

## METRIC (U.S. Customary)

### Interior Vehicle And Body Dimensions – Key Sheet

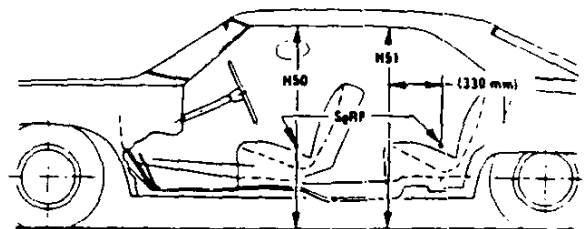
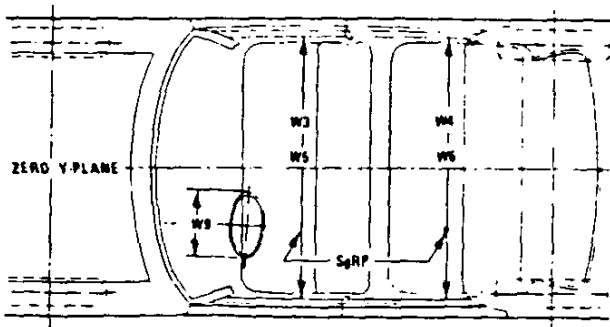
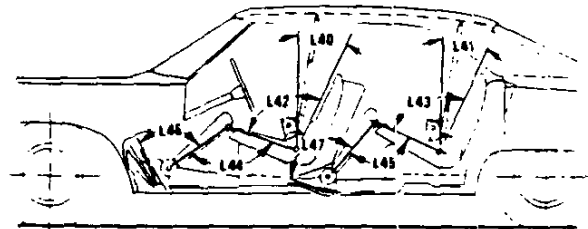
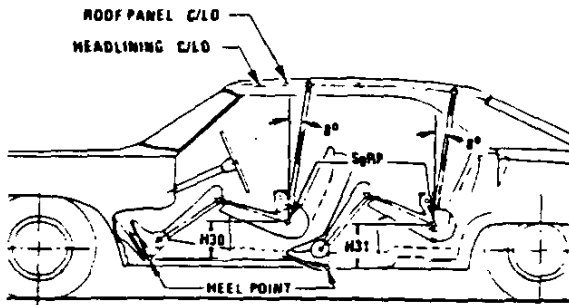
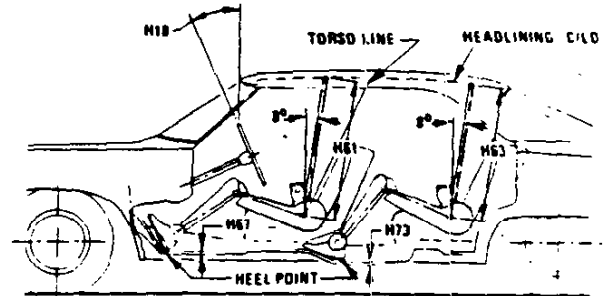
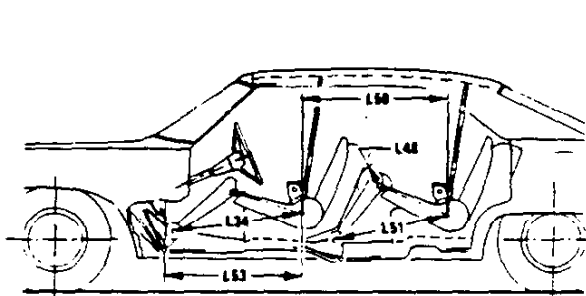

**MVMA Specifications**  
**METRIC (U.S. Customary)**

**Interior Vehicle And Body Dimensions - Key Sheet**

**Third Seat**

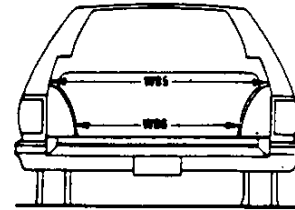
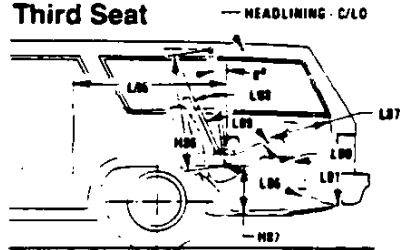

**Cargo Space**

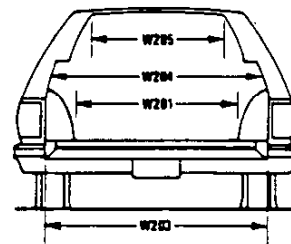
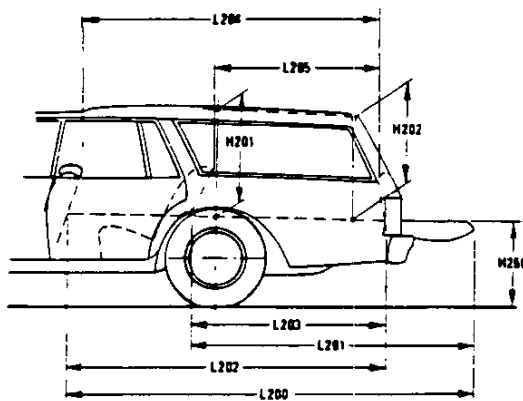

**Station Wagon**

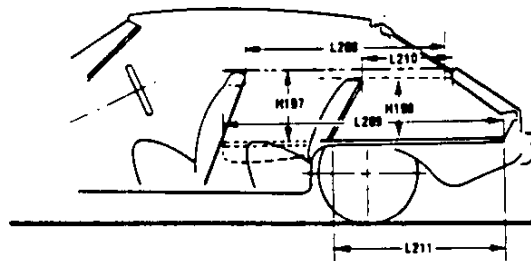

**Hatchback**

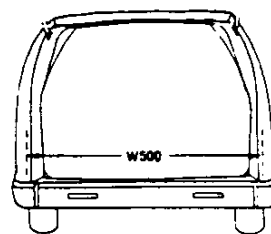
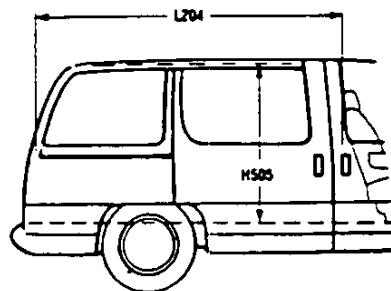

**⊘ Multipurpose Vehicle**

# MVMA Specifications

## METRIC (U.S. Customary)

### Exterior Vehicle And Body Dimensions – Key Sheet Dimensions Definitions

#### Seating Reference Point

SEATING REFERENCE POINT means the manufacturer's design reference point which –

- (a) Establishes the rearmost normal design driving or riding position of each designated seating position in a vehicle;
- (b) Has coordinates established relative to the design vehicle structure;
- (c) Simulates the position of the pivot center of the human torso and thigh; and
- (d) Is the reference point employed to position the two dimensional templates described in SAE Recommended Practice J826, "Devices for Use in Defining and Measuring Vehicle Seating Accommodations."

#### Width Dimensions

- W101 TREAD – FRONT. The dimension measured between the tire centerlines at the ground.
- W102 TREAD – REAR. The dimension measured between the tire centerlines at the ground. In case of dual wheels, the dimension will be measured to the centerline of tire and wheel assemblies.
- W103 VEHICLE WIDTH. The maximum dimension measured between the widest point on the vehicle, excluding exterior mirrors, flexible mud flaps, marker lamps, but including bumpers, moldings, sheet metal protrusions or dual wheels, if standard equipment.
- W117 BODY WIDTH AT SgRP – FRONT. The dimension measured laterally between the widest points on the body at the SgRP-front, excluding door handles, applied moldings, or appliques.
- W120 VEHICLE WIDTH – FRONT DOORS OPEN. The dimension measured between the widest point on the front doors in maximum hold-open position.
- W121 VEHICLE WIDTH – REAR DOORS OPEN. The dimension measured between the widest point on the rear doors in maximum hold-open position. For vehicles with a rear door on only one side, this dimension is to the zero "Y" plane.
- W122 TUMBLE – HOME. STRAIGHT SIDE GLASS. The angle measured from a vertical to the outside surface of the front door glass at the SgRP "X" plane.  
CURVED SIDE GLASS. The angle measured from a vertical to a chord extending from the upper DLO to the lower DLO at the outside surface of the front door glass at the front SgRP "X" plane.
- W410 OUTSIDE MIRROR WIDTH. The dimension between the widest point on the outside mirrors. The standard right and left mirror adjusted for normal driving will be shown unless otherwise noted. When only one outside mirror is standard, the dimension will be to the zero "Y" plane.

#### Length Dimensions

- L101 WHEELBASE (WB). The dimension measured longitudinally between front and rear wheel centerlines. In case of dual rear axles, the dimension shall be to the midpoint of the centerlines of the rear wheels.
- L103 VEHICLE LENGTH. The maximum dimension measured longitudinally between the foremost point and the rearmost point on the vehicle, including bumper, bumper guards, tow hooks and or rub strips, if standard equipment.
- L104 OVERHAND – FRONT. The dimension measured longitudinally from the centerline of the front wheels to the foremost point on the vehicle including bumper, bumper guards, tow hooks and or rub strips, if standard equipment.
- L105 OVERHANG – REAR. The dimension measured longitudinally from the centerline of the rear wheels; or in the case of dual rear axles, the dimension shall be the midpoint of the centerlines of the rear wheels, to the rearmost point on the vehicle including rear bumpers, bumper guards, tow hooks and rub strips, if standard equipment.

- L123 UPPER STRUCTURE LENGTH. The dimension measured longitudinally from the cowl point to the deck point.
- L127 REAR WHEEL CENTERLINE "X" COORDINATE or in the case of dual rear axles, the coordinate shall be the midpoint of the distance between the rear axle centerlines.

#### Height Dimensions

- H101 VEHICLE HEIGHT. The dimension measured vertically from the highest point on the vehicle body to ground.
- H111 ROCKER PANEL – REAR TO GROUND. The dimension measured vertically from the bottom of the rocker or side quarter panel at the front of the rear wheel opening, excluding flanges, to ground.
- H112 ROCKER PANEL – FRONT TO GROUND. The dimension measured vertically from the foremost point on the bottom of the rocker panels, excluding flanges, to ground.
- H114 COWL POINT TO GROUND. Measured at zero "Y" plane.
- H121 BACKLIGHT SLOPE ANGLE. The angle between the vertical reference line and the surface of backlight at vehicle zero "Y" plane. For curve backlight, the angle is to chord of backlight arc from lower DLO to upper DLO.
- H122 WINDSHIELD SLOPE ANGLE. The angle between the vertical reference line and a chord of the windshield arc running from the lower DLO to the upper DLO at the vehicle zero "Y" plane. In the case of wrap over glass, the angle to be measured will be formed by a chord 457 mm (18.0 in.) long drawn from the lower DLO to the intersecting point on the windshield.
- H138 DECK POINT TO GROUND. Measured at zero "Y" plane.
- H109 STATIC LOAD – TIRE RADIUS – REAR. Specified by the manufacturer in accordance with composite TIRE SECTION STANDARD.

#### Ground Clearance Dimensions

- H102 FRONT BUMPER TO GROUND. The minimum dimension measured vertically from the lowest point on the front bumper to ground, including bumper guards, if standard equipment.
- H103 FRONT BUMPER TO GROUND – CURB MASS (WT.). Measured in the same manner as H102.
- H104 REAR BUMPER TO GROUND. The minimum dimension measured vertically from the lowest point on the rear bumper to ground, including bumper guards, if standard equipment.
- H105 REAR BUMPER TO GROUND – CURB MASS (WT.). Measured in the same manner as H104.
- H106 ANGLE OF APPROACH. The angle measured between a line tangent to the front tire static loaded radius arc and the initial point of structural interference forward of the front tire to ground. The limiting structural component shall be designated.
- H107 ANGLE OF DEPARTURE. The angle measured between a line tangent to the rear tire static loaded radius arc and the initial point structural interference rearward of the rear tire to ground. The limiting component shall be designated.
- H147 RAMP BREAKOVER ANGLE. The angle measured between two lines tangent to the front and rear tire static loaded radius and intersecting at a point on the underside of the vehicle which defines the largest ramp over which the vehicle can roll.
- H153 REAR AXLE DIFFERENTIAL TO GROUND. The minimum dimension measured from the rear axle differential to ground.
- H156 MINIMUM RUNNING GROUND CLEARANCE. The minimum dimension measured from the sprung vehicle to ground. Specify location.

# MVMA Specifications

## METRIC (U.S. Customary)

### Interior Vehicle And Body Dimensions - Key Sheet

#### Dimensions Definitions

#### V2 STATION WAGON

Measured in inches:

$$\frac{W4 \times H201 \times L204}{1728} = \text{ft}^3$$

Measured in mm:

$$\frac{W4 \times H201 \times L204}{10^9} = \text{m}^3 \text{ (cubic meter)}$$

#### V4 HIDDEN LUGGAGE CAPACITY - REAR OF FRONT SEAT.

The total volumes of individual pieces of one set of standard luggage stowed in any hidden cargo area below the load floor rear of the front seat.

#### V5 TRUCKS AND MPV'S WITH OPEN AREA.

Measured in inches:

$$\frac{L506 \times W505 \times H503}{1728} = \text{ft}^3$$

Measured in mm:

$$\frac{L506 \times W500 \times H503}{10^9} = \text{m}^3 \text{ (cubic meter)}$$

#### V6 TRUCKS AND MPV'S WITH CLOSED AREA.

Measured in inches:

$$\frac{L204 \times W500 \times H505}{1728} = \text{ft}^3$$

Measured in mm:

$$\frac{L204 \times W500 \times H505}{10^9} = \text{m}^3 \text{ (cubic meter)}$$

#### HIDDEN LUGGAGE CAPACITY - REAR OF SECOND SEAT.

The total volume of individual pieces of one set of standard luggage stowed in any hidden cargo area below the load floor rear of the second seat.

#### V10 STATION WAGON CARGO VOLUME INDEX.

Measured in inches:

$$\frac{H201 \times L205 \times \frac{W4 - W201}{2}}{1728} = \text{ft}^3$$

Measured in mm:

$$\frac{H201 \times L205 \times \frac{W4 - W201}{2}}{10^9} = \text{m}^3 \text{ (cubic meter)}$$

#### Hatchback - Cargo Space Dimensions

All hatchback cargo dimensions are to be taken with the front seat in full down and rear position, and the rear seat folded down. The hatchback door is in the closed position. (For electronically adjusted seats, see the manufacturer's specifications for Design "H" Point).

**L208 CARGO LENGTH AT FRONT SEATBACK HEIGHT.** The minimum horizontal dimension from the "X" plane tangent to the rearmost surface of the driver's seatback to the inside limiting interference of the hatchback door on the vehicle zero "Y" plane.

**L209 CARGO LENGTH AT FLOOR - FRONT.** The minimum horizontal dimension measured at floor level from the rear of the front seatback to the normal limiting interference of the hatchback door on the vehicle zero "Y" plane.

**L210 CARGO LENGTH AT SECOND SEATBACK HEIGHT.** The minimum dimension measured from the "X" plane tangent to the rearmost surface of second seatback or the load floor which is stowed at least one half of the H198 dimension height above the rear load floor, to the rearmost inside limiting interference on the zero "X" plane.

**L211 CARGO LENGTH AT FLOOR - SECOND SEATBACK.** The minimum horizontal dimension measured at floor level from the rear of the second seatback or load floor panel to the normal limiting interference of the hatchback door on the vehicle zero "Y" plane.

**H197 FRONT SEATBACK TO LOAD HEIGHT.** The dimension measured vertically from the horizontal tangent to the top of the seatback to the undepressed floor covering.

**H198 SECOND SEATBACK TO LOAD FLOOR HEIGHT.** The dimension measured vertically from the second seatback to the undepressed floor covering.

#### V3 HATCHBACK.

Measured in inches:

$$\frac{\frac{L208 + L209}{2} \times W4 \times H197}{1728} = \text{ft}^3$$

Measured in mm:

$$\frac{\frac{L208 + L209}{2} \times W4 \times H197}{10^9} = \text{m}^3 \text{ (cubic meter)}$$

**V4 HIDDEN LUGGAGE CAPACITY - REAR OF FRONT SEAT.** The total volumes of individual pieces of one set of standard luggage stowed in any hidden cargo area below the load floor rear of the front seat.

**V11 HATCHBACK CARGO VOLUME INDEX.** Usable luggage (one (1) stand and luggage set) below floor:

Measured in inches:

$$\frac{\frac{L210 + L211}{2} \times W4 \times H198}{1728} = \text{ft}^3$$

Measured in mm:

$$\frac{\frac{L210 + L211}{2} \times W4 \times H198}{10^9} = \text{m}^3 \text{ (cubic meter)}$$

# MVMA Specifications

METRIC (U.S. Customary)

## Index

Subject	Page No.	Subject	Page No.
Alternator	16	Passenger Capacity	1
Axle Drive, Front, Rear, All Four	2, 9, 10	Passenger Mass Distribution	26
Axle Shafts	10	Pistons	3
Battery	16	Power Brakes	12
Body and Miscellaneous Information	17	Power, Engine	2
Brakes - Parking Service	12, 13	Power Steering	14
Camber	15	Power Teams	2
Camshaft	3	Propeller Shaft	10
Capacities		Pumps - Fuel	6
Cooling System	5	Water	5
Fuel Tank	6	Radiator - Cap, Hoses, Core	5
Lubricants		Ratios - Axle, Transaxle	2, 9, 10
Engine Crankcase	4	Compression	2
Transmission Transaxle	8, 9	Steering	14
Rear Axle	10	Transmission Transaxle	2, 8, 9
Carburetor	2, 6	Rear Axle	2, 10
Caster	15	Regulator - Alternator	16
Climate Control System	19	Restraint System	18
Clutch - Pedal Operated	8	Rims	13
Coil, Ignition	16	Rods - Connecting	4
Connecting Rods	4	Scrub Radius	14
Convenience Equipment	20-21	Seats	17
Cooling System	5	Shock Absorbers, Front & Rear	11
Crankshaft	4	Spark Plugs	16
Cylinders and Cylinder Head	3	Speedometer	15
Diesel Information	4	Springs - Front & Rear Suspension	11
Dimension Definitions		Stabilizer (Sway Bar) - Front & Rear	11
Key Sheet - Exterior	28, 31, 32	Starting System	16
Key Sheet - Interior	29, 30, 32, 33, 34	Steering	14
Electrical System	15, 16	Suppression - Ignition, Radio	16
Emission Controls	7	Suspension - Front & Rear	11
Engine - General		Tail Pipe	7
Bore, Stroke, Type	3	Theft Protection	21
Compression Ratio	2	Thermostat, Cooling	5
Displacement	2, 3	Tires	13
Firing Order, Cylinder Numbering	3	Toe-In	15
General Information, Power & Torque	2	Torque Converter	9
Intake System	4	Torque - Engine	2, 8, 9
Power Teams	2	Trailer Towing	21
Exhaust System	7	Transaxle	9
Equipment Availability, Convenience	20	Transmission - Types	2, 8, 9
Fan, Cooling	5	Transmission - Automatic	2, 9
Filters - Engine Oil, Fuel System	4	Transmission - Manual	2, 8
Four Wheel Drive	10	Transmission - Ratios	2, 8, 9
Frame	17	Tread	22
Front Suspension	11	Trunk Cargo Load	1
Front Wheel Drive Unit	10	Trunk Luggage Capacity	23
Fuel Economy, EPA	1	Turning Diameter	14
Fuel Injection	6	Unutilized Construction	18
Fuel System	6	Universal Joints, Propeller Shaft	10
Fuel Tank	6	Valve System	4
Glass	18	Vehicle Dimensions	
Headlamps	18	Width	22
Headroom - Body	23, 24	Length	22
Heights	22	Height	22
Horns	15	Ground Clearance	22
Horsepower - Brake	2	Front Compartment	23
Ignition System	16	Rear Compartment	23
Initiation - Tires	13	Luggage Compartment	23
Interior Volumes	23	Station Wagon - Third Seat	24
Instruments	15	Station Wagon - Cargo Space	24
Legroom	23, 24	Hatchback - Cargo Space	24
Lengths	22	Fiducial Marks	25
Leveling, Suspension	11	Voltage Regulator	16
Liters, Valve	4	Water Pump	5
Linings - Clutch, Brake	8, 12	Weights	26, 27
Lubrication - Engine Transmission Transaxle	4, 8, 9	Wheel Alignment	15
Luggage Compartment	23	Wheelbase	22
Models	1	Wheels & Tires	13
Motor Starting	16	Wheel Spindle	11
Muffler	7	Widths	21
Origin	1	Windshield	18
		Windshield Wiper and Washer	15